

PNP Epitaxial Silicon Transistor

KSA1013

Features

- Color TV Audio Output
- Color TV Vertical Deflection Output

ABSOLUTE MAXIMUM RATINGS

($T_A = 25^\circ\text{C}$ unless otherwise noted.)

Symbol	Parameter	Ratings	Unit
V_{CB0}	Collector-Base Voltage	-160	V
V_{CEO}	Collector-Emitter Voltage	-160	V
V_{EBO}	Emitter-Base Voltage	-6	V
I_C	Collector Current	-1	A
I_B	Base Current	-0.5	A
T_J	Junction Temperature	150	$^\circ\text{C}$
T_{STG}	Storage Temperature	-55 to +150	$^\circ\text{C}$

Stresses exceeding those listed in the Maximum Ratings table may damage the device. If any of these limits are exceeded, device functionality should not be assumed, damage may occur and reliability may be affected.

THERMAL CHARACTERISTICS (Note 1)

($T_A = 25^\circ\text{C}$ unless otherwise noted.)

Symbol	Parameter	Value	Unit
P_D	Power Dissipation	900	mW
	Derate Above $T_A = 25^\circ\text{C}$	7.2	mW/ $^\circ\text{C}$
$R_{\theta JA}$	Thermal Resistance, Junction-to-Ambient	139	$^\circ\text{C}/\text{W}$

1. PCB size: FR-4, 76 mm \times 114 mm \times 1.57 mm (3.0 inch \times 4.5 inch \times 0.062 inch) with minimum land pattern size.

ELECTRICAL CHARACTERISTICS ($T_A = 25^\circ\text{C}$ unless otherwise noted.)

Symbol	Parameter	Conditions	Min	Typ	Max	Unit
I_{CBO}	Collector Cut-off Current	$V_{CB} = -150\text{ V}, I_E = 0$	-	-	-1	μA
I_{EBO}	Emitter Cut-off Current	$V_{BE} = -6\text{ V}, I_C = 0$	-	-	-1	μA
BV_{CEO}	Collector-Emitter Breakdown Voltage	$I_C = -10\text{ mA}, I_B = 0$	-160	-	-	V
h_{FE}	DC Current Gain	$V_{CE} = -5\text{ V}, I_C = -200\text{ mA}$	60	-	320	
$V_{CE}(\text{sat})$	Collector-Emitter Saturation Voltage	$I_C = -500\text{ mA}, I_B = -50\text{ mA}$	-	-	-1.5	V
$V_{BE}(\text{on})$	Base-Emitter On Voltage	$V_{CE} = -5\text{ V}, I_C = -5\text{ mA}$	-0.45	-	-0.75	V
f_T	Current Gain Bandwidth Product	$V_{CE} = -5\text{ V}, I_C = -200\text{ mA}$	15	50	-	MHz
C_{ob}	Output Capacitance	$V_{CB} = -10\text{ V}, I_E = 0, f = 1\text{ MHz}$	-	-	35	pF

Product parametric performance is indicated in the Electrical Characteristics for the listed test conditions, unless otherwise noted. Product performance may not be indicated by the Electrical Characteristics if operated under different conditions.

h_{FE} Classification

Classification	R	O	Y
h_{FE}	60 ~ 120	100 ~ 200	160 ~ 320

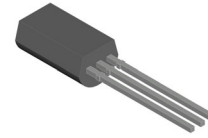

TO-92 3
CASE 135AP

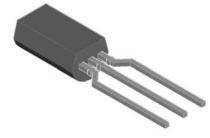

TO-92 3 LF
CASE 135AM

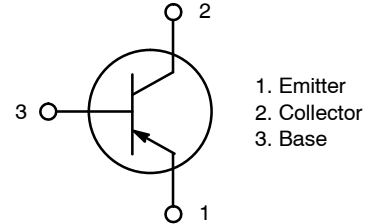

MARKING DIAGRAM

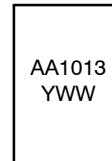

A = Assembly Site
A1013 = Specific Device Code
Y = Year of Production
WW = Work Week

ORDERING INFORMATION

Device	Package	Shipping
KSA1013YBU	TO-92 3 (Pb-Free)	6000 Units / Bulk
KSA1013YTA	TO-92 3 LF (Pb-Free)	2000 Units / Ammo

TYPICAL PERFORMANCE CHARACTERISTICS

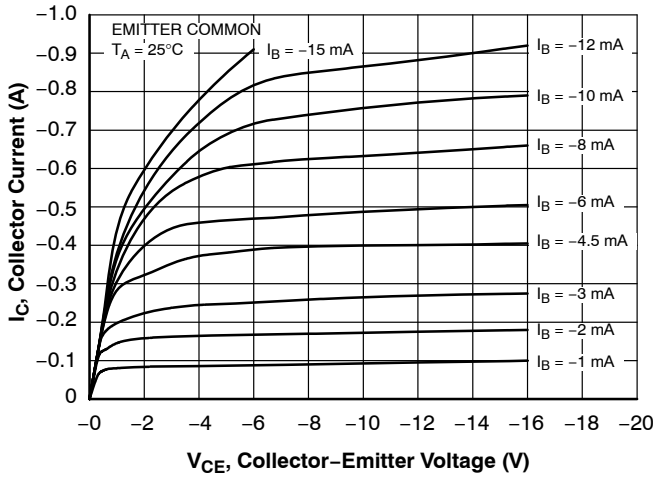

Figure 1. Static Characteristic

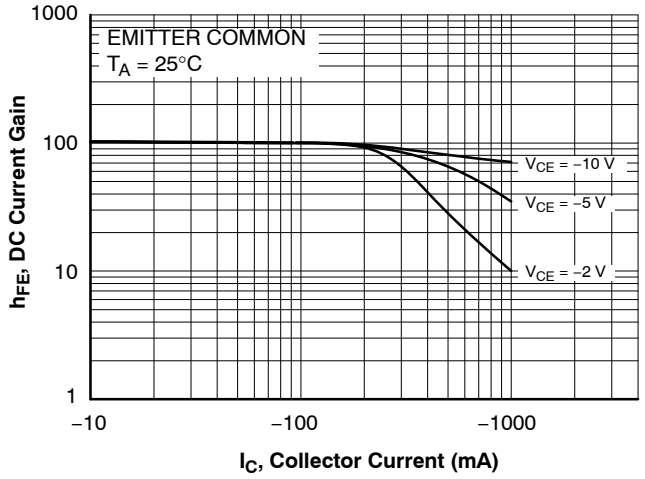

Figure 2. DC Current Gain

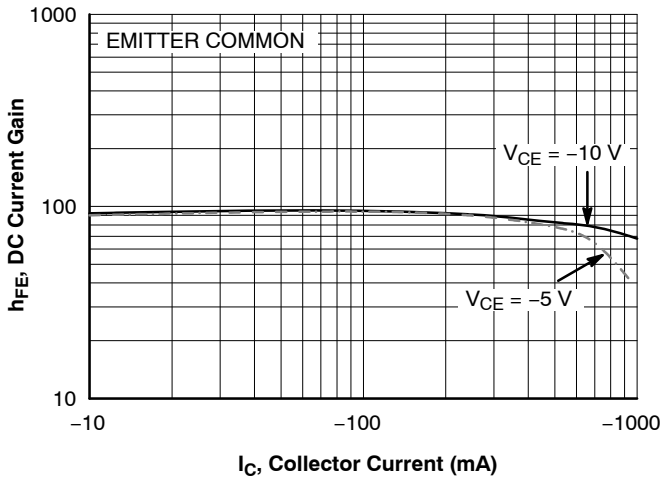

Figure 3. DC Current Gain

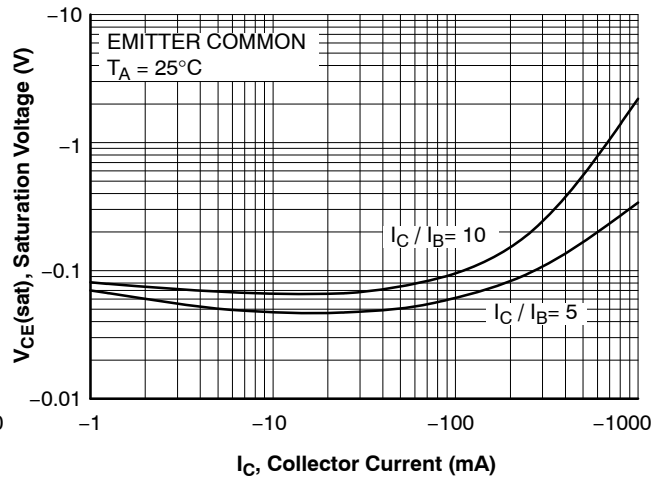

Figure 4. Collector-Emitter Saturation Voltage

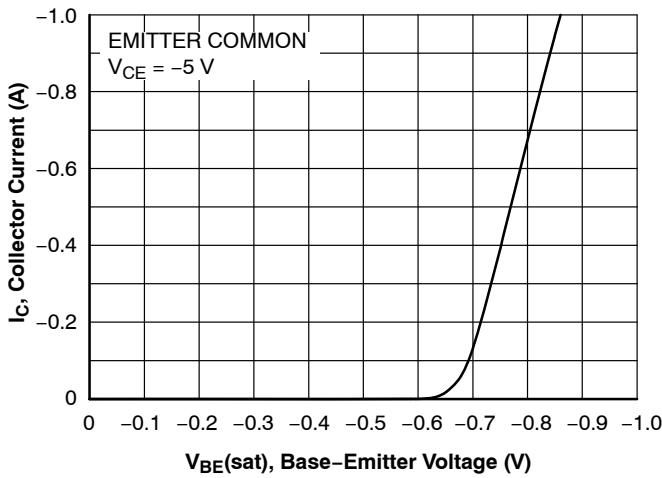

Figure 5. Base-Emitter On Voltage

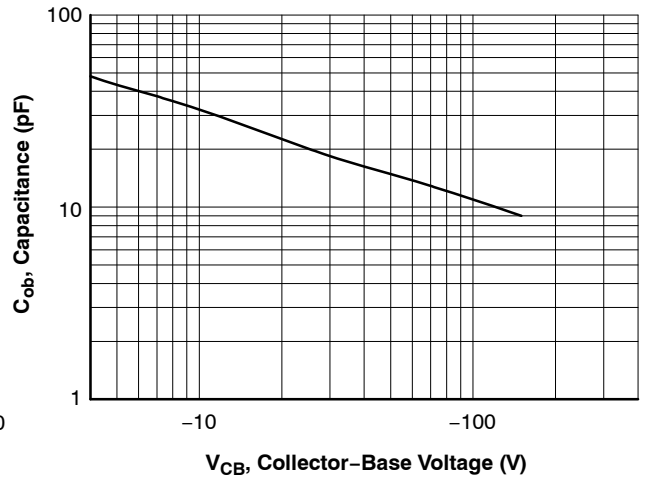

Figure 6. Collector Output Capacitance

TYPICAL PERFORMANCE CHARACTERISTICS (CONTINUED)

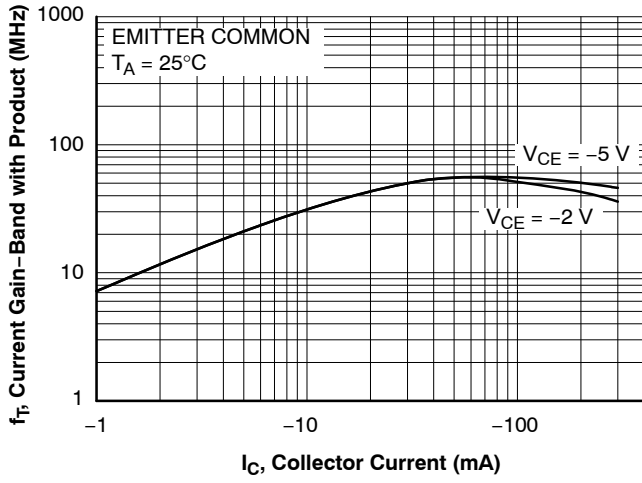

Figure 7. Current Gain Bandwidth Product

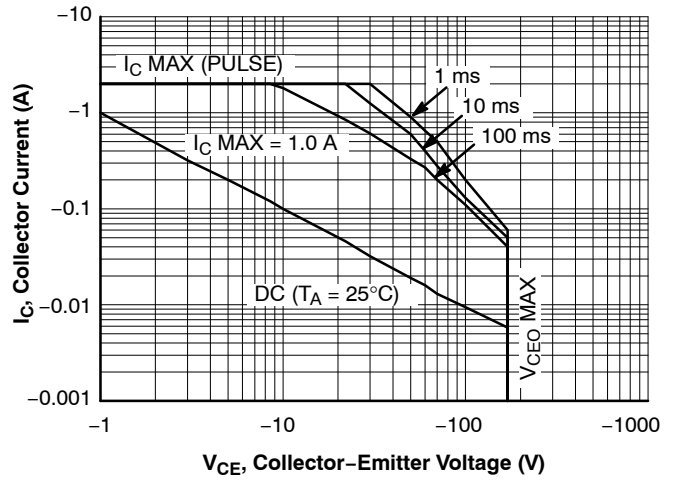
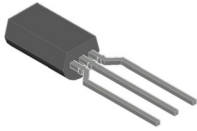

Figure 8. Safe Operating Area

MECHANICAL CASE OUTLINE

PACKAGE DIMENSIONS

ON Semiconductor®



TO-92 3 8.0x4.9 (LEADFORMED)

CASE 135AM
ISSUE B

DATE 14 JAN 2021



TOP VIEW

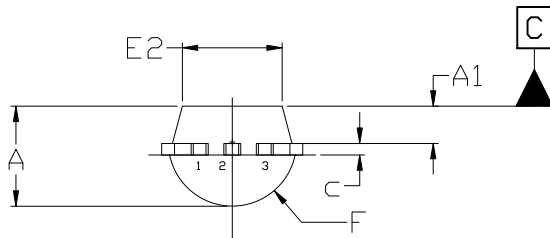

END VIEW

NOTES:

1. DIMENSIONING AND TOLERANCING PER ASME Y14.5M, 2009.
2. CONTROLLING DIMENSION: MILLIMETERS
3. DIMENSIONS ARE EXCLUSIVE OF BURRS, MOLD FLASH, GATE REMAINS AND TIE BAR PROTRUSIONS.
4. DIMENSION b AND b2 DOES NOT INCLUDE DAMBAR PROTRUSION. DIMENSION b2 LOCATED ABOVE THE DAMBAR PORTION OF MIDDLE LEAD.

DIM	MILLIMETERS		
	MIN.	NOM.	MAX.
A	3.70	3.90	4.10
A1	1.25	1.45	1.65
b	0.35	0.50	0.60
b2	0.62	---	0.78
c	0.35	0.45	0.55
D	7.80	8.00	8.20
E	4.70	4.90	5.10
E2	3.70	3.90	4.10
e	1.27 BSC		
e2	2.50 BSC		
F	2.45 REF		
L	13.00 REF		
L2	1.50	---	1.90
L3	2.60	---	3.40
L4	10.40 REF		

DOCUMENT NUMBER:	98AON14058G	Electronic versions are uncontrolled except when accessed directly from the Document Repository. Printed versions are uncontrolled except when stamped "CONTROLLED COPY" in red.
DESCRIPTION:	TO-92 3 8.0X4.9 (LEADFORMED)	PAGE 1 OF 1

ON Semiconductor and are trademarks of Semiconductor Components Industries, LLC dba ON Semiconductor or its subsidiaries in the United States and/or other countries. ON Semiconductor reserves the right to make changes without further notice to any products herein. ON Semiconductor makes no warranty, representation or guarantee regarding the suitability of its products for any particular purpose, nor does ON Semiconductor assume any liability arising out of the application or use of any product or circuit, and specifically disclaims any and all liability, including without limitation special, consequential or incidental damages. ON Semiconductor does not convey any license under its patent rights nor the rights of others.

MECHANICAL CASE OUTLINE

PACKAGE DIMENSIONS

ON Semiconductor®

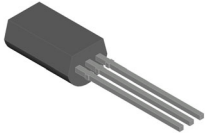

TO-92 3 8.0x4.9
CASE 135AP
ISSUE A

DATE 13 JAN 2021

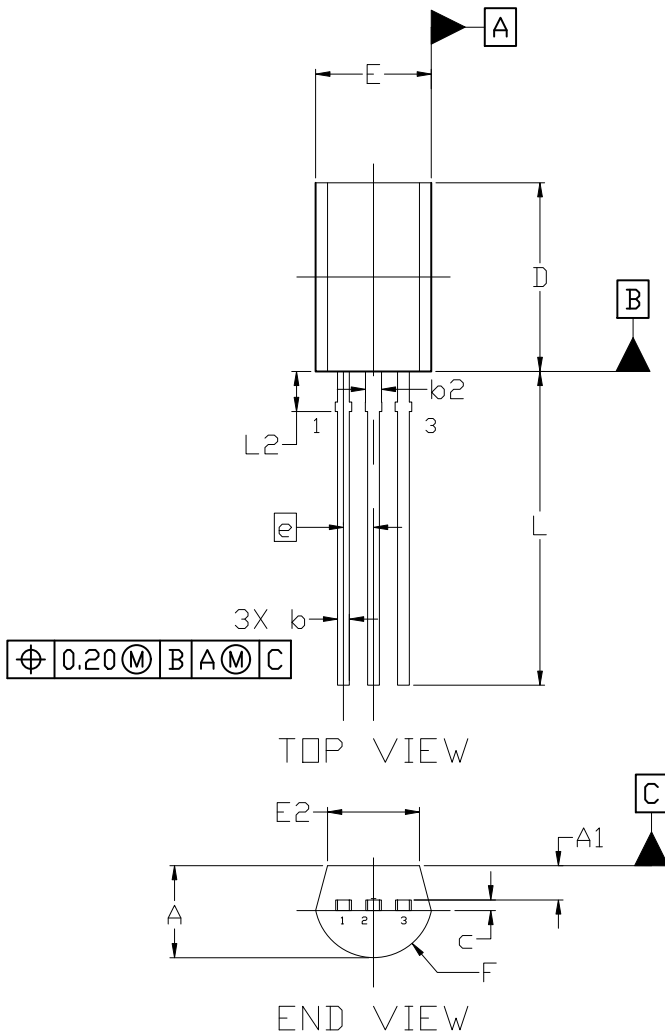

NOTES:

1. DIMENSIONING AND TOLERANCING PER ASME Y14.5M, 2009.
2. CONTROLLING DIMENSION: MILLIMETERS
3. DIMENSIONS ARE EXCLUSIVE OF BURRS, MOLD FLASH, GATE REMAINS AND TIE BAR PROTRUSIONS.
4. DIMENSION b AND $b2$ DOES NOT INCLUDE DAMBAR PROTRUSION. DIMENSION $b2$ LOCATED ABOVE THE DAMBAR PORTION OF MIDDLE LEAD.

DIM	MILLIMETERS		
	MIN.	NOM.	MAX.
A	3.70	3.90	4.10
A1	1.25	1.45	1.65
b	0.40	0.50	0.60
b2	0.62	---	0.78
c	0.35	0.45	0.55
D	7.80	8.00	8.20
E	4.70	4.90	5.10
E2	3.70	3.90	4.10
e	1.27 BSC		
F	2.45 REF		
L	13.30	---	14.20
L2	1.70 REF		

DOCUMENT NUMBER:	98AON13873G	Electronic versions are uncontrolled except when accessed directly from the Document Repository. Printed versions are uncontrolled except when stamped "CONTROLLED COPY" in red.
DESCRIPTION:	TO-92 3 8.0X4.9	PAGE 1 OF 1

ON Semiconductor and are trademarks of Semiconductor Components Industries, LLC dba ON Semiconductor or its subsidiaries in the United States and/or other countries. ON Semiconductor reserves the right to make changes without further notice to any products herein. ON Semiconductor makes no warranty, representation or guarantee regarding the suitability of its products for any particular purpose, nor does ON Semiconductor assume any liability arising out of the application or use of any product or circuit, and specifically disclaims any and all liability, including without limitation special, consequential or incidental damages. ON Semiconductor does not convey any license under its patent rights nor the rights of others.

onsemi, **Onsemi**, and other names, marks, and brands are registered and/or common law trademarks of Semiconductor Components Industries, LLC dba "**onsemi**" or its affiliates and/or subsidiaries in the United States and/or other countries. **onsemi** owns the rights to a number of patents, trademarks, copyrights, trade secrets, and other intellectual property. A listing of **onsemi**'s product/patent coverage may be accessed at www.onsemi.com/site/pdf/Patent-Marking.pdf. **onsemi** reserves the right to make changes at any time to any products or information herein, without notice. The information herein is provided "as-is" and **onsemi** makes no warranty, representation or guarantee regarding the accuracy of the information, product features, availability, functionality, or suitability of its products for any particular purpose, nor does **onsemi** assume any liability arising out of the application or use of any product or circuit, and specifically disclaims any and all liability, including without limitation special, consequential or incidental damages. Buyer is responsible for its products and applications using **onsemi** products, including compliance with all laws, regulations and safety requirements or standards, regardless of any support or applications information provided by **onsemi**. "Typical" parameters which may be provided in **onsemi** data sheets and/or specifications can and do vary in different applications and actual performance may vary over time. All operating parameters, including "Typicals" must be validated for each customer application by customer's technical experts. **onsemi** does not convey any license under any of its intellectual property rights nor the rights of others. **onsemi** products are not designed, intended, or authorized for use as a critical component in life support systems or any FDA Class 3 medical devices or medical devices with a same or similar classification in a foreign jurisdiction or any devices intended for implantation in the human body. Should Buyer purchase or use **onsemi** products for any such unintended or unauthorized application, Buyer shall indemnify and hold **onsemi** and its officers, employees, subsidiaries, affiliates, and distributors harmless against all claims, costs, damages, and expenses, and reasonable attorney fees arising out of, directly or indirectly, any claim of personal injury or death associated with such unintended or unauthorized use, even if such claim alleges that **onsemi** was negligent regarding the design or manufacture of the part. **onsemi** is an Equal Opportunity/Affirmative Action Employer. This literature is subject to all applicable copyright laws and is not for resale in any manner.

ADDITIONAL INFORMATION

TECHNICAL PUBLICATIONS:

Technical Library: www.onsemi.com/design/resources/technical-documentation
onsemi Website: www.onsemi.com

ONLINE SUPPORT: www.onsemi.com/support

For additional information, please contact your local Sales Representative at www.onsemi.com/support/sales