

High Voltage XPT™ IGBT

IXYT25N250CHV IXYH25N250CHV

$$V_{CES} = 2500V$$

$$I_{C110} = 25A$$

$$V_{CE(sat)} \leq 4.0V$$

$$t_{fi(typ)} = 246ns$$

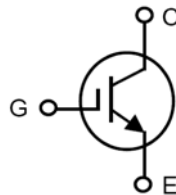

Symbol	Test Conditions	Maximum Ratings	
V_{CES}	$T_J = 25^\circ C$ to $175^\circ C$	2500	V
V_{CGR}	$T_J = 25^\circ C$ to $175^\circ C$, $R_{GE} = 1M\Omega$	2500	V
V_{GES}	Continuous	± 20	V
V_{GEM}	Transient	± 30	V
I_{C25}	$T_C = 25^\circ C$	95	A
I_{C110}	$T_C = 110^\circ C$	25	A
I_{CM}	$T_C = 25^\circ C$, 1ms	235	A
SSOA (RBSOA)	$V_{GE} = 15V$, $T_{VJ} = 150^\circ C$, $R_G = 5\Omega$	$I_{CM} = 100$	A
	Clamped Inductive Load	1500	V
P_C	$T_C = 25^\circ C$	937	W
T_J		-55 ... +175	$^\circ C$
T_{JM}		175	$^\circ C$
T_{stg}		-55 ... +175	$^\circ C$
T_L	Maximum Lead Temperature for Soldering	300	$^\circ C$
T_{SOLD}	Plastic Body for 10s	260	$^\circ C$
M_d	Mounting Torque	1.13/10	Nm/lb.in
Weight	TO-268HV	4	g
	TO-247HV	6	g

TO-268HV (IXYT)

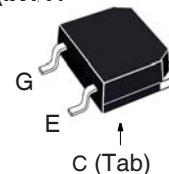

TO-247HV (IXYH)

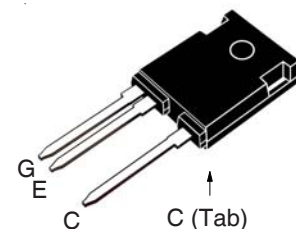

G = Gate C = Drain
E = Source Tab = Drain

Features

- High Voltage Package
- High Blocking Voltage
- High Peak Current Capability
- Low Saturation Voltage

Advantages

- Low Gate Drive Requirement
- High Power Density

Applications

- Switch-Mode and Resonant-Mode Power Supplies
- Uninterruptible Power Supplies (UPS)
- Laser Generators
- Capacitor Discharge Circuits
- AC Switches

Symbol	Test Conditions ($T_J = 25^\circ C$, Unless Otherwise Specified)	Characteristic Values		
		Min.	Typ.	Max.
BV_{CES}	$I_C = 250\mu A$, $V_{GE} = 0V$	2500		V
$V_{GE(th)}$	$I_C = 250\mu A$, $V_{CE} = V_{GE}$	3.0		5.0 V
I_{CES}	$V_{CE} = V_{CES}$, $V_{GE} = 0V$ $T_J = 100^\circ C$		100	25 μA μA
I_{GES}	$V_{CE} = 0V$, $V_{GE} = \pm 20V$			± 100 nA
$V_{CE(sat)}$	$I_C = 25A$, $V_{GE} = 15V$, Note 1 $T_J = 150^\circ C$		3.4 4.7	4.0 V V

Symbol Test Conditions

($T_J = 25^\circ\text{C}$ Unless Otherwise Specified)

Characteristic Values

		Min.	Typ.	Max.	
g_{fs}	$I_C = 25\text{A}, V_{CE} = 10\text{V}$, Note 1	16	27		S
R_{Gi}	Gate Input Resistance		2.8		Ω
C_{ies}	$V_{CE} = 25\text{V}, V_{GE} = 0\text{V}, f = 1\text{MHz}$		3060		pF
C_{oes}			114		pF
C_{res}			43		pF
$Q_{g(on)}$	$I_C = 25\text{A}, V_{GE} = 15\text{V}, V_{CE} = 0.5 \cdot V_{CES}$		147		nC
Q_{ge}			16		nC
Q_{gc}			68		nC
$t_{d(on)}$	Inductive load, $T_J = 25^\circ\text{C}$ $I_C = 25\text{A}, V_{GE} = 15\text{V}$ $V_{CE} = 0.5 \cdot V_{CES}, R_G = 5\Omega$ Note 2		15		ns
t_{ri}			34		ns
E_{on}			8.3		mJ
$t_{d(off)}$			230		ns
t_{fi}			246		ns
E_{off}		7.3		mJ	
$t_{d(on)}$	Inductive load, $T_J = 150^\circ\text{C}$ $I_C = 25\text{A}, V_{GE} = 15\text{V}$ $V_{CE} = 0.5 \cdot V_{CES}, R_G = 5\Omega$ Note 2		18		ns
t_{ri}			33		ns
E_{on}			11.0		mJ
$t_{d(off)}$			225		ns
t_{fi}			350		ns
E_{off}		10.5		mJ	
R_{thJC}				0.16 $^\circ\text{C/W}$	
R_{thCS}		0.15		$^\circ\text{C/W}$	

TO-268HV Outline

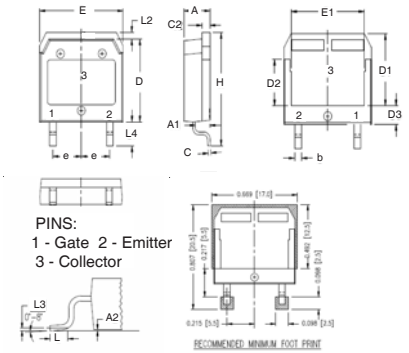

SYM	INCHES		MILLIMETER	
	MIN	MAX	MIN	MAX
A	.193	.201	4.90	5.10
A1	.106	.114	2.70	2.90
A2	.001	.010	0.02	0.25
b	.045	.057	1.15	1.45
C	.016	.026	0.40	0.65
C2	.057	.063	1.45	1.60
D	.543	.551	13.80	14.00
D1	.465	.476	11.80	12.10
D2	.295	.307	7.50	7.80
D3	.114	.126	2.90	3.20
E	.624	.632	15.85	16.05
E1	.524	.535	13.30	13.60
\square	.215	BSC	5.45	BSC
H	.736	.752	18.70	19.10
L	.067	.079	1.70	2.00
L2	.039	.045	1.00	1.15
L3	.010	BSC	0.25	BSC
L4	.150	.161	3.80	4.10

TO-247HV Outline

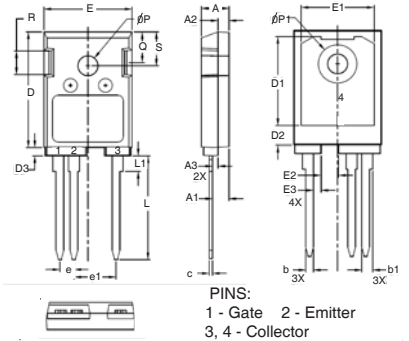

SYM	INCHES		MILLIMETERS	
	MIN	MAX	MIN	MAX
A	.193	.201	4.90	5.10
A1	.114	.122	2.90	3.10
A2	.075	.083	1.90	2.10
A3	.035	.043	0.90	1.10
b	.053	.059	1.35	1.50
b1	.075	.083	1.90	2.10
c	.022	.030	0.55	0.75
D	.819	.843	20.80	21.40
D1	.638	.646	16.20	16.40
D2	.134	.146	3.40	3.70
D3	.055	.063	1.40	1.60
E	.622	.638	15.80	16.20
E1	.520	.528	13.20	13.40
E2	.118	.126	3.00	3.20
E3	.051	.059	1.30	1.50
e	.100	BSC	2.54	BSC
e1	.300	BSC	7.62	BSC
L	.732	.748	18.60	19.00
L1	.106	.118	2.70	3.00
ϕP	.138	.142	3.50	3.60
$\phi P1$.272	.280	6.90	7.10
Q	.216	.224	5.50	5.70
R	.165	.169	4.20	4.30
S	.240	.248	6.10	6.30

Note: 1. Pulse test, $t \leq 300\mu\text{s}$, duty cycle, $d \leq 2\%$.

ADVANCE TECHNICAL INFORMATION

The product presented herein is under development. The Technical Specifications offered are derived from a subjective evaluation of the design, based upon prior knowledge and experience, and constitute a "considered reflection" of the anticipated result. IXYS reserves the right to change limits, test conditions, and dimensions without notice.

IXYS Reserves the Right to Change Limits, Test Conditions, and Dimensions.

IXYS MOSFETs and IGBTs are covered by one or more of the following U.S. patents:

4,835,592	4,931,844	5,049,961	5,237,481	6,162,665	6,404,065 B1	6,683,344	6,727,585	7,005,734 B2	7,157,338 B2
4,860,072	5,017,508	5,063,307	5,381,025	6,259,123 B1	6,534,343	6,710,405 B2	6,759,692	7,063,975 B2	
4,881,106	5,034,796	5,187,117	5,486,715	6,306,728 B1	6,583,505	6,710,463	6,771,478 B2	7,071,537	

Fig. 1. Output Characteristics @ $T_J = 25^\circ\text{C}$

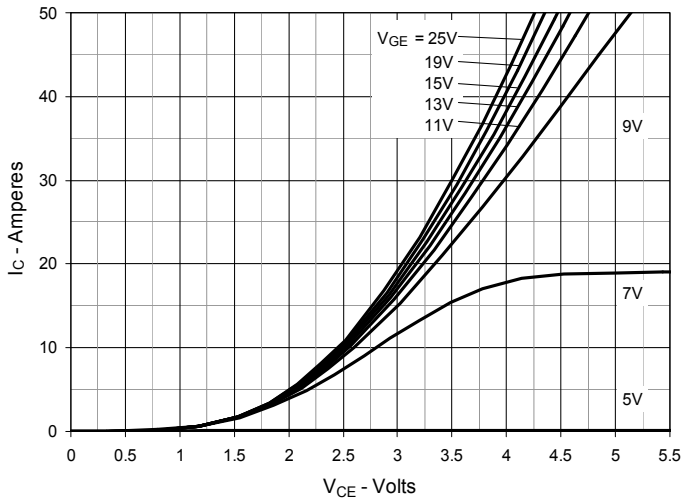

Fig. 2. Extended Output Characteristics @ $T_J = 25^\circ\text{C}$

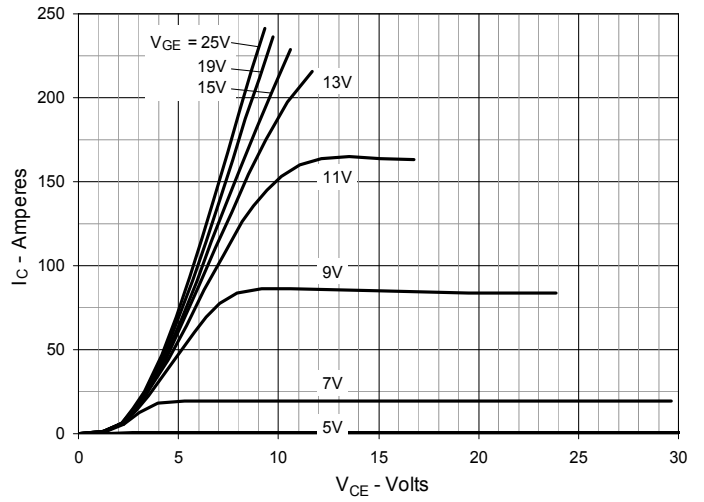

Fig. 3. Output Characteristics @ $T_J = 150^\circ\text{C}$

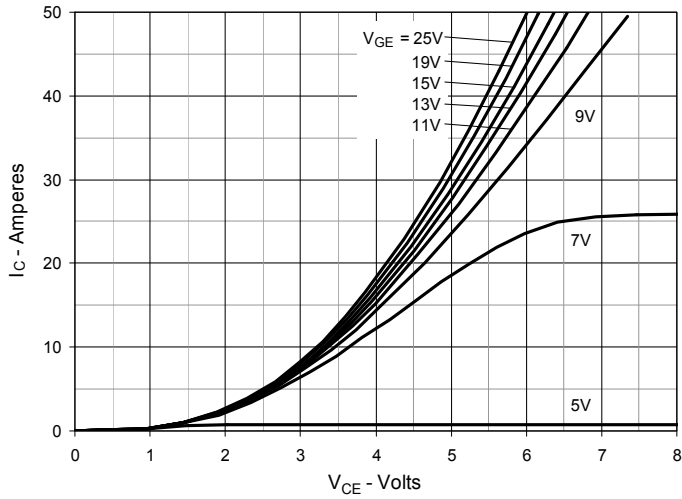

Fig. 4. Dependence of $V_{CE(sat)}$ on Junction Temperature

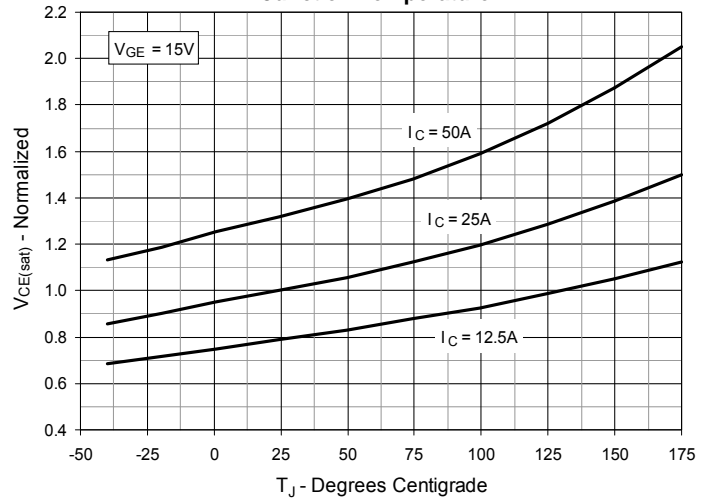

Fig. 5. Collector-to-Emitter Voltage vs. Gate-to-Emitter Voltage

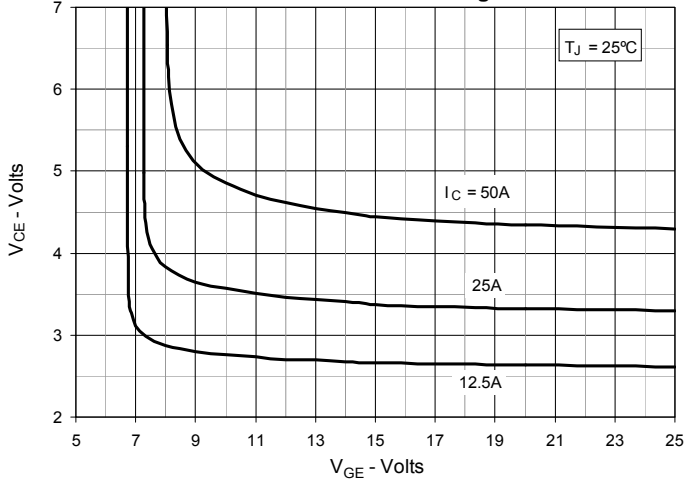

Fig. 6. Input Admittance

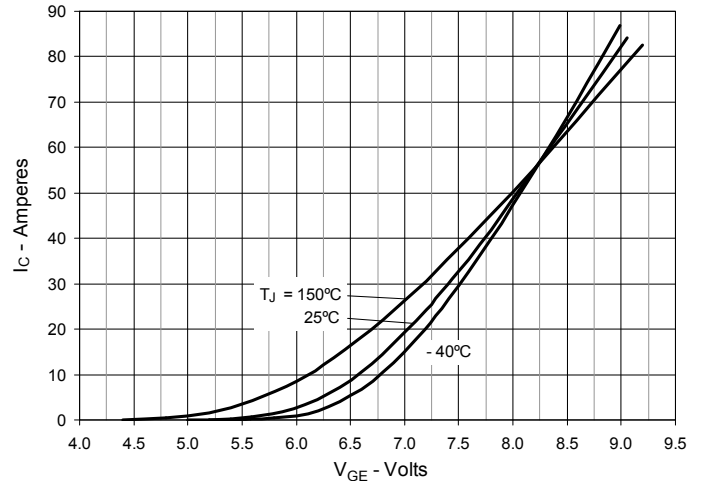

Fig. 7. Transconductance

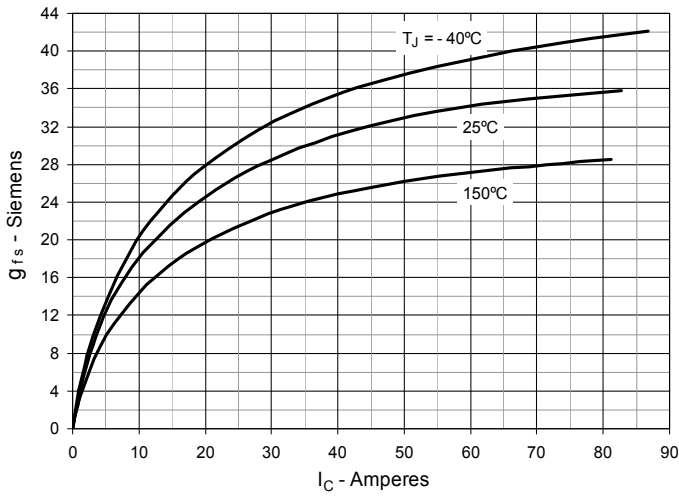

Fig. 8. Gate Charge

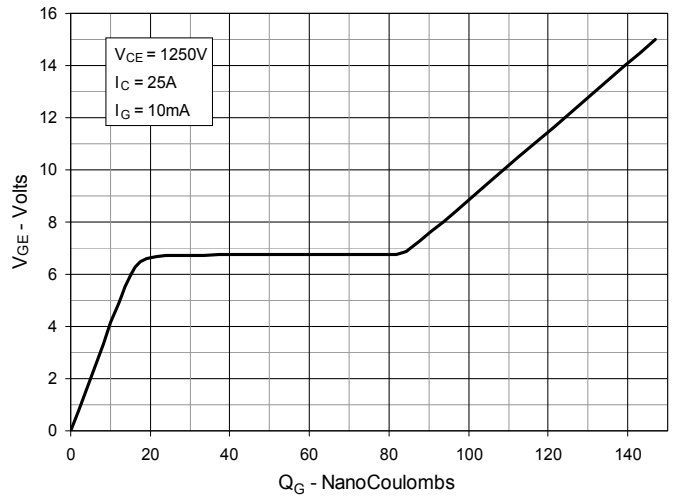

Fig. 9. Capacitance

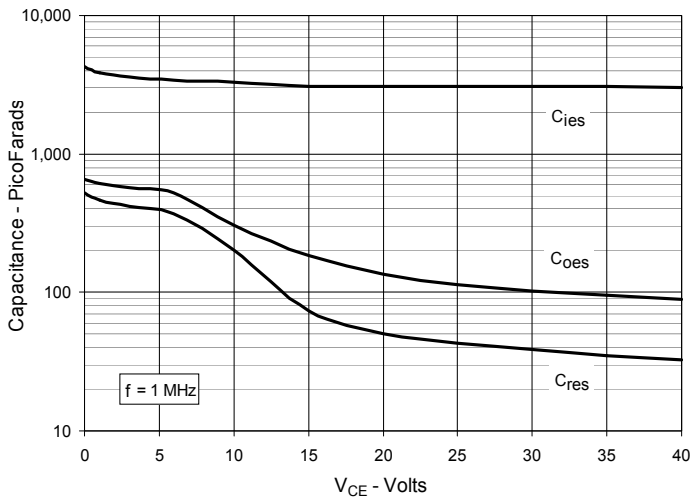

Fig. 10. Reverse-Bias Safe Operating Area

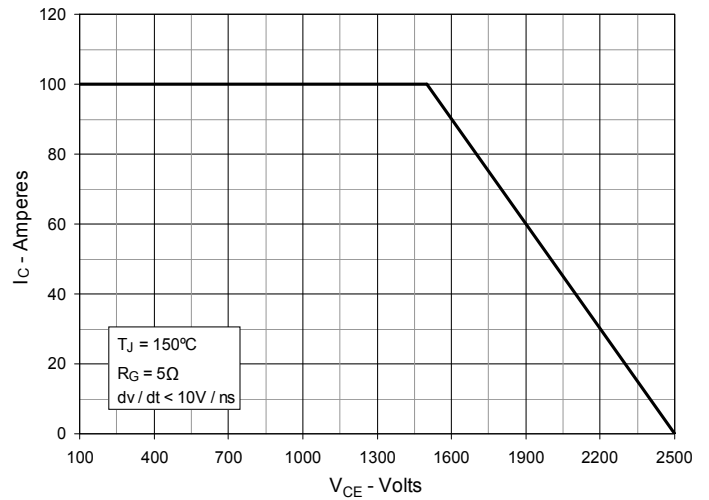

Fig. 11. Forward-Bias Safe Operating Area

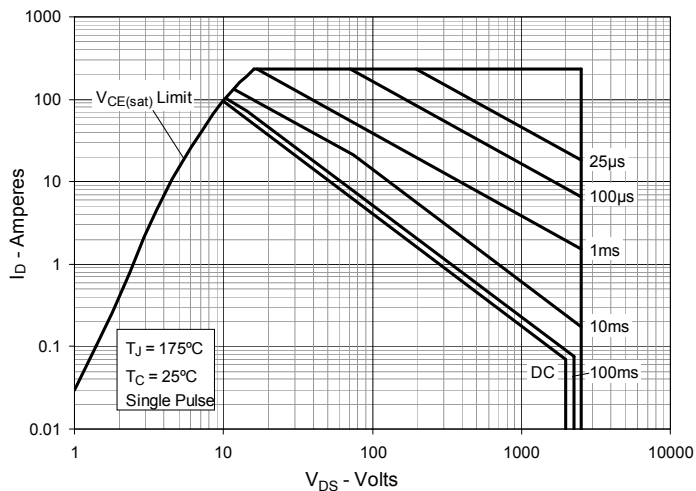

Fig. 12. Maximum Transient Thermal Impedance

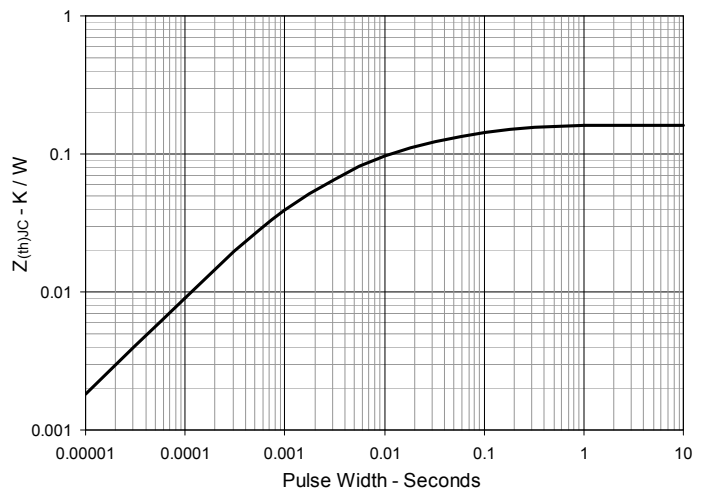

Fig. 13. Inductive Switching Energy Loss vs. Gate Resistance

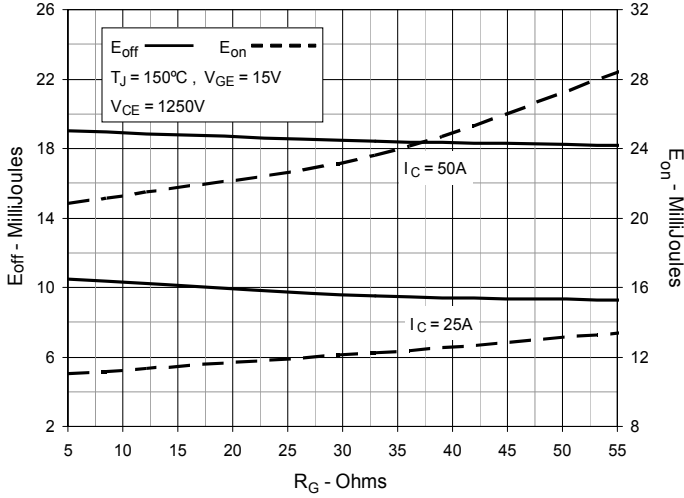

Fig. 14. Inductive Switching Energy Loss vs. Collector Current

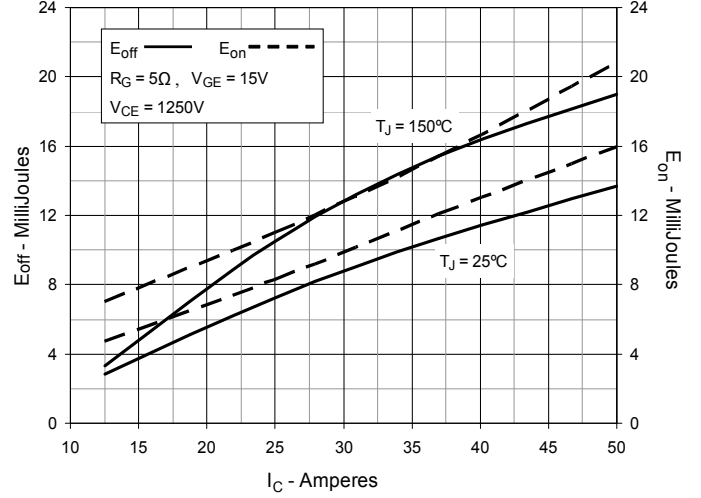

Fig. 15. Inductive Switching Energy Loss vs. Junction Temperature

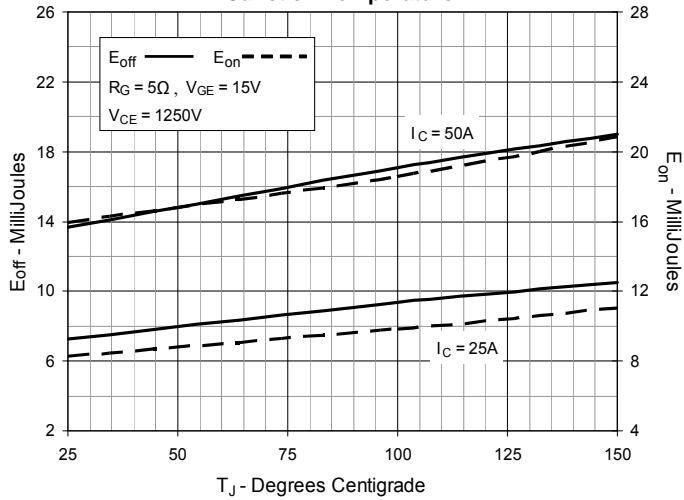

Fig. 16. Inductive Turn-off Switching Times vs. Gate Resistance

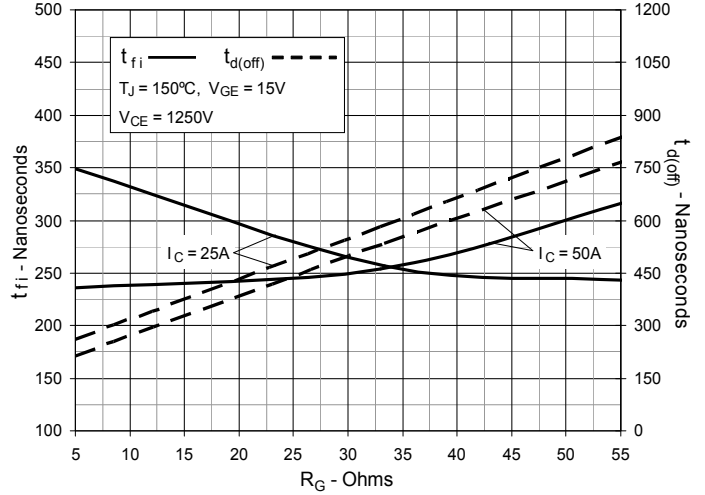

Fig. 17. Inductive Turn-off Switching Times vs. Collector Current

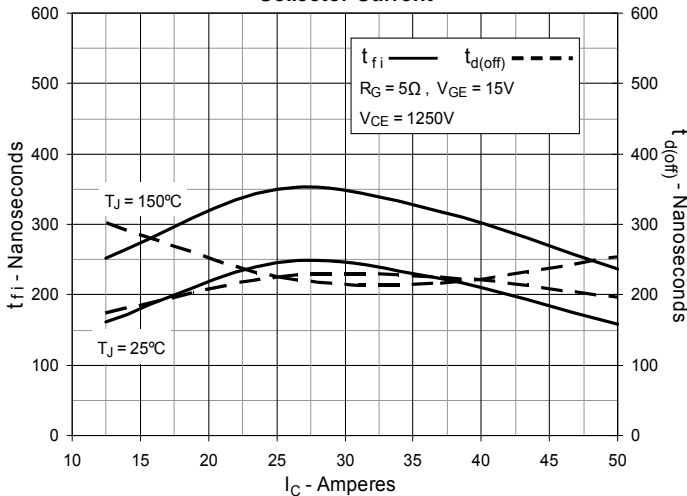

Fig. 18. Inductive Turn-off Switching Times vs. Junction Temperature

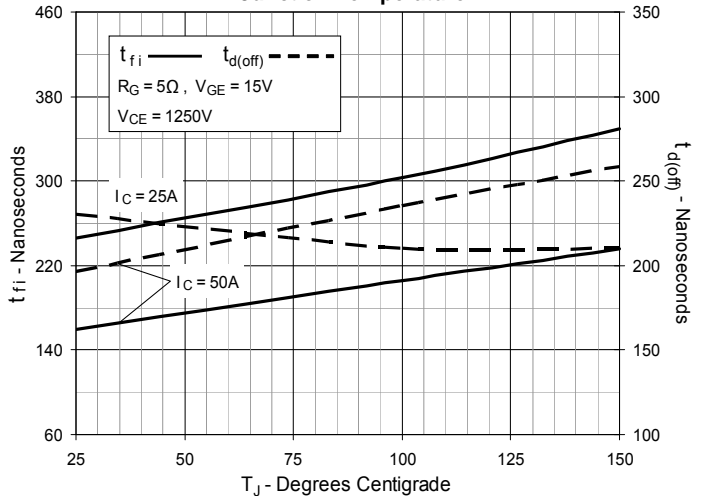

Fig. 19. Inductive Turn-on Switching Times vs. Gate Resistance

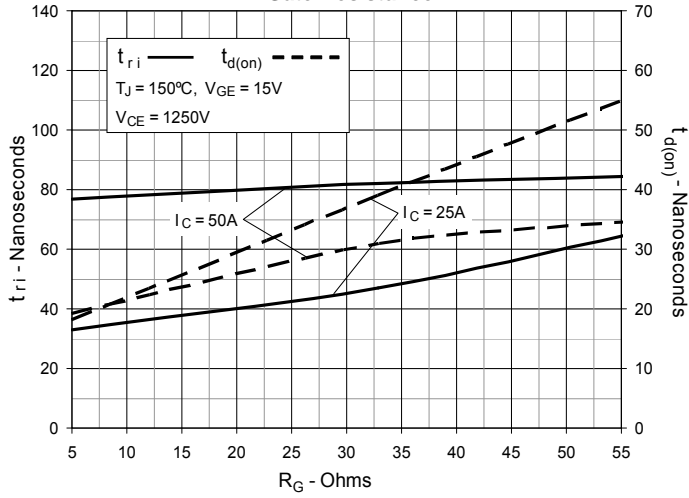

Fig. 20. Inductive Turn-on Switching Times vs. Collector Current

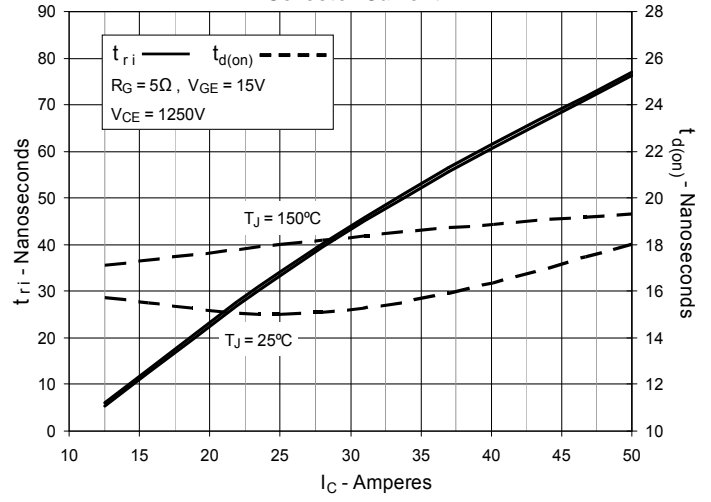
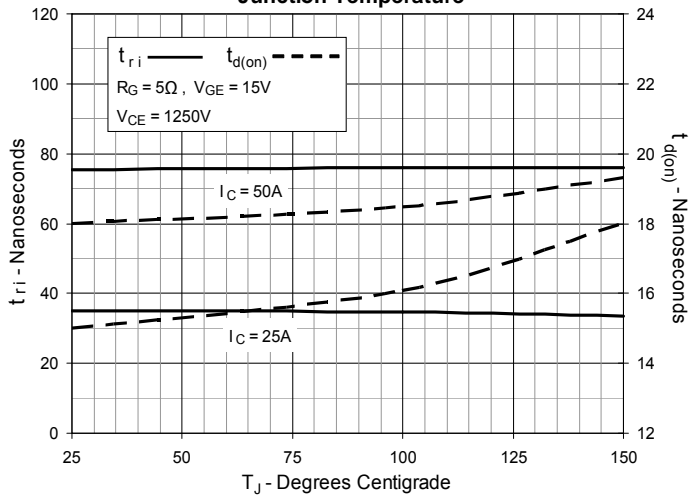

Fig. 21. Inductive Turn-on Switching Times vs. Junction Temperature





Disclaimer Notice - Information furnished is believed to be accurate and reliable. However, users should independently evaluate the suitability of and test each product selected for their own applications. Littelfuse products are not designed for, and may not be used in, all applications. Read complete Disclaimer Notice at www.littelfuse.com/disclaimer-electronics.