

**BiMOSFET™ Monolithic
Bipolar MOS Transistor**

**IXBK75N170A
IXBX75N170A**

$V_{CES} = 1700V$
 $I_{C90} = 65A$
 $V_{CE(sat)} \leq 6.00V$
 $t_{fi(typ)} = 60ns$

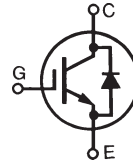

Symbol	Test Conditions	Maximum Ratings	
V_{CES}	$T_J = 25^\circ C$ to $150^\circ C$	1700	V
V_{CGR}	$T_J = 25^\circ C$ to $150^\circ C$, $R_{GE} = 1M\Omega$	1700	V
V_{GES}	Continuous	± 20	V
V_{GEM}	Transient	± 30	V
I_{C25}	$T_C = 25^\circ C$	110	A
I_{C90}	$T_C = 90^\circ C$	65	A
I_{CM}	$T_C = 25^\circ C$, 1ms	300	A
SSOA	$V_{GE} = 15V$, $T_{VJ} = 125^\circ C$, $R_G = 1\Omega$	$I_{CM} = 100$	A
(RBSOA)	Clamped Inductive Load	$V_{CE} \leq 0.8 \cdot V_{CES}$	
P_C	$T_C = 25^\circ C$	1040	W
T_J		-55 ... +150	$^\circ C$
T_{JM}		150	$^\circ C$
T_{stg}		-55 ... +150	$^\circ C$
T_L	Maximum Lead Temperature for Soldering	300	$^\circ C$
T_{SOLD}	1.6 mm (0.062 in.) from Case for 10	260	$^\circ C$
M_d	Mounting Torque (TO-264)	1.13/10	Nm/lb.in.
F_c	Mounting Force (PLUS247)	20..120/4.5..27	N/lb.
Weight	TO-264	10	g
	PLUS247	6	g

TO-264 (IXBK)

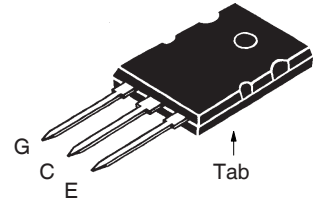

PLUS247™ (IXBX)

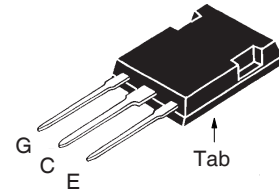

G = Gate C = Collector
 E = Emitter Tab = Collector

Features

- International Standard Packages
- High Blocking Voltage
- Fast Switching
- High Current Handling Capability
- Anti-Parallel Diode

Advantages

- High Power Density
- Low Gate Drive Requirement
- Intergrated Diode Can Be Used for Protection

Applications

- Switch-Mode and Resonant-Mode Power Supplies
- UPS
- AC Motor Drives
- Substitutes for High Voltage MOSFET

Symbol	Test Conditions ($T_J = 25^\circ C$, Unless Otherwise Specified)	Characteristic Values		
		Min.	Typ.	Max.
BV_{CES}	$I_C = 250\mu A$, $V_{GE} = 0V$	1700		V
$V_{GE(th)}$	$I_C = 1.5mA$, $V_{CE} = V_{GE}$	2.5		5.5 V
I_{CES}	$V_{CE} = 0.8 \cdot V_{CES}$, $V_{GE} = 0V$ $T_J = 125^\circ C$			50 μA 3 mA
I_{GES}	$V_{CE} = 0V$, $V_{GE} = \pm 20V$			± 100 nA
$V_{CE(sat)}$	$I_C = 42A$, $V_{GE} = 15V$, Note 1 $T_J = 125^\circ C$	4.95 5.15		6.00 V V

Symbol Test Conditions

($T_J = 25^\circ\text{C}$ Unless Otherwise Specified)

Characteristic Values

Min. Typ. Max.

g_{fs}	$I_C = 42\text{A}, V_{CE} = 10\text{V}, \text{Note 1}$	28	48	S	
C_{ies}	$V_{CE} = 25\text{V}, V_{GE} = 0\text{V}, f = 1\text{MHz}$		7200	pF	
C_{oes}			450	pF	
C_{res}			150	pF	
Q_g	$I_C = 42\text{A}, V_{GE} = 15\text{V}, V_{CE} = 0.5 \cdot V_{CES}$		358	nC	
Q_{ge}			46	nC	
Q_{gc}			148	nC	
$t_{d(on)}$	Inductive load, $T_J = 25^\circ\text{C}$ $I_C = 42\text{A}, V_{GE} = 15\text{V}$ $V_{CE} = 0.8 \cdot V_{CES}, R_G = 1\Omega$ Note 2		26	ns	
t_{ri}			40	ns	
$t_{d(off)}$			418	ns	
t_{fi}			60	110	ns
E_{off}			3.80	7.00	mJ
$t_{d(on)}$	Inductive load, $T_J = 125^\circ\text{C}$ $I_C = 42\text{A}, V_{GE} = 15\text{V}$ $V_{CE} = 0.8 \cdot V_{CES}, R_G = 1\Omega$ Note 2		27	ns	
t_{ri}			38	ns	
$t_{d(off)}$			420	ns	
t_{fi}			175	ns	
E_{off}			6.35	mJ	
R_{thJC}			0.12	$^\circ\text{C/W}$	
R_{thCS}		0.15		$^\circ\text{C/W}$	

TO-264 AA (IXBK) Outline

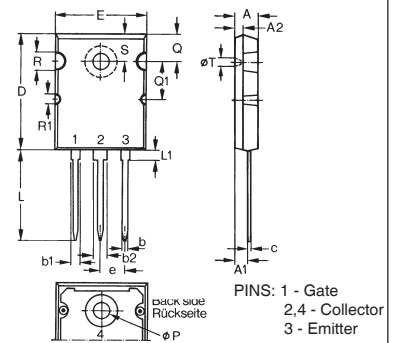

Dim.	Millimeter		Inches	
	Min.	Max.	Min.	Max.
A	4.82	5.13	.190	.202
A1	2.54	2.89	.100	.114
A2	2.00	2.10	.079	.083
b	1.12	1.42	.044	.056
b1	2.39	2.69	.094	.106
b2	2.90	3.09	.114	.122
c	0.53	0.83	.021	.033
D	25.91	26.16	1.020	1.030
E	19.81	19.96	.780	.786
e	5.46 BSC		.215 BSC	
J	0.00	0.25	.000	.010
K	0.00	0.25	.000	.010
L	20.32	20.83	.800	.820
L1	2.29	2.59	.090	.102
P	3.17	3.66	.125	.144
Q	6.07	6.27	.239	.247
Q1	8.38	8.69	.330	.342
R	3.81	4.32	.150	.170
R1	1.78	2.29	.070	.090
S	6.04	6.30	.238	.248
T	1.57	1.83	.062	.072

Reverse Diode

Symbol Test Conditions

($T_J = 25^\circ\text{C}$ Unless Otherwise Specified)

Characteristic Values

Min. Typ. Max

V_F	$I_F = 42\text{A}, V_{GE} = 0\text{V}, \text{Note 1}$		5.5	V
t_{rr}	$I_F = 42\text{A}, V_{GE} = 0\text{V}, -di_F/dt = 100\text{A}/\mu\text{s}$		360	ns
I_{RM}			19	A
Q_{RM}	$V_R = 100\text{V}, V_{GE} = 0\text{V}$		3.5	μC

Notes:

1. Pulse test, $t \leq 300\mu\text{s}$; duty cycle, $d \leq 2\%$.
2. Switching times & energy losses may increase for higher V_{CE} (Clamp), T_J or R_G .

Additional provisions for lead-to-lead isolation are required at $V_{CE} > 1200\text{V}$.

PLUS 247™ (IXBX) Outline

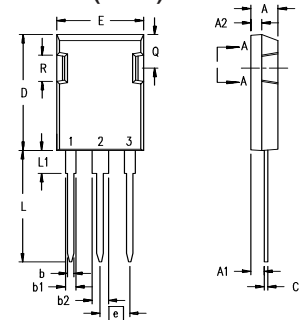

Terminals: 1 - Gate
2 - Collector
3 - Emitter

Dim.	Millimeter		Inches	
	Min.	Max.	Min.	Max.
A	4.83	5.21	.190	.205
A ₁	2.29	2.54	.090	.100
A ₂	1.91	2.16	.075	.085
b	1.14	1.40	.045	.055
b ₁	1.91	2.13	.075	.084
b ₂	2.92	3.12	.115	.123
C	0.61	0.80	.024	.031
D	20.80	21.34	.819	.840
E	15.75	16.13	.620	.635
e	5.45 BSC		.215 BSC	
L	19.81	20.32	.780	.800
L1	3.81	4.32	.150	.170
Q	5.59	6.20	.220	0.244
R	4.32	4.83	.170	.190

IXYS Reserves the Right to Change Limits, Test Conditions, and Dimensions.

IXYS MOSFETs and IGBTs are covered by one or more of the following U.S. patents:	4,835,592	4,931,844	5,049,961	5,237,481	6,162,665	6,404,065 B1	6,683,344	6,727,585	7,005,734 B2	7,157,338 B2
	4,860,072	5,017,508	5,063,307	5,381,025	6,259,123 B1	6,534,343	6,710,405 B2	6,759,692	7,063,975 B2	
	4,881,106	5,034,796	5,187,117	5,486,715	6,306,728 B1	6,583,505	6,710,463	6,771,478 B2	7,071,537	

Fig. 1. Output Characteristics @ $T_J = 25^\circ\text{C}$

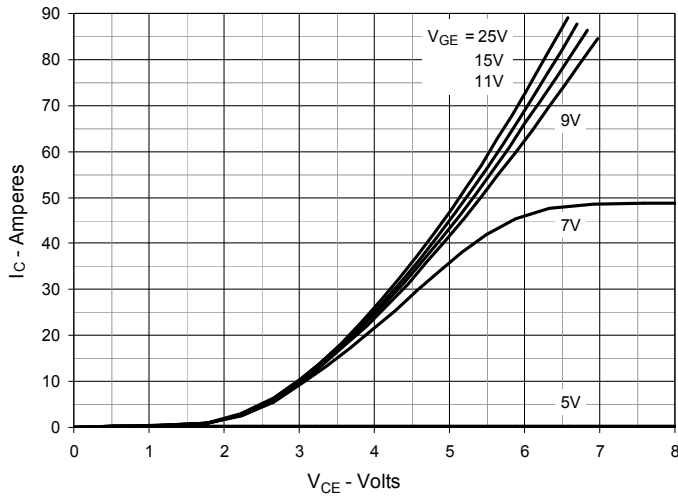

Fig. 2. Extended Output Characteristics @ $T_J = 25^\circ\text{C}$

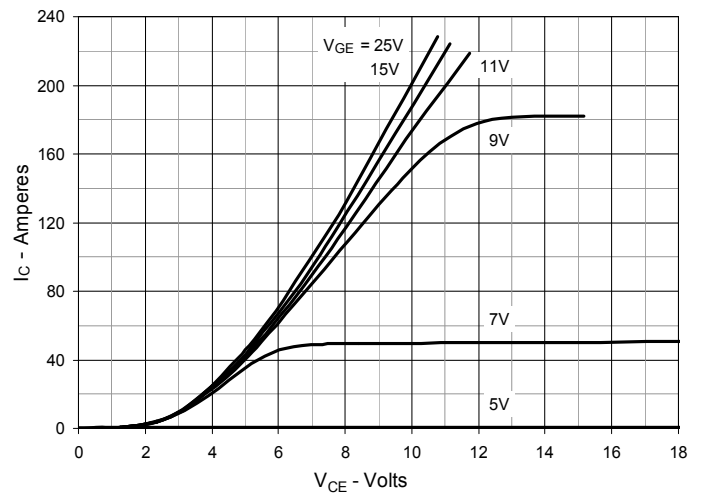

Fig. 3. Output Characteristics @ $T_J = 125^\circ\text{C}$

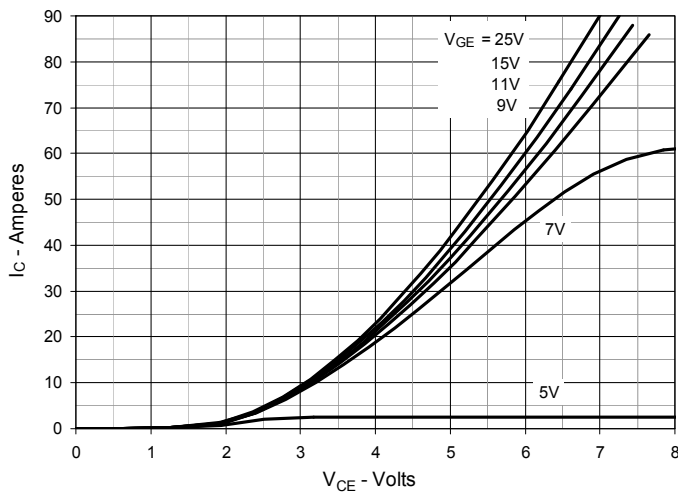

Fig. 4. Dependence of $V_{CE(sat)}$ on Junction Temperature

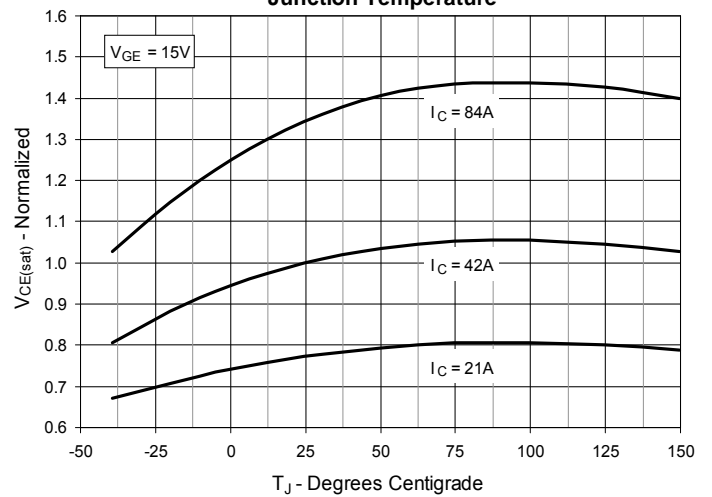

Fig. 5. Collector-to-Emitter Voltage vs. Gate-to-Emitter Voltage

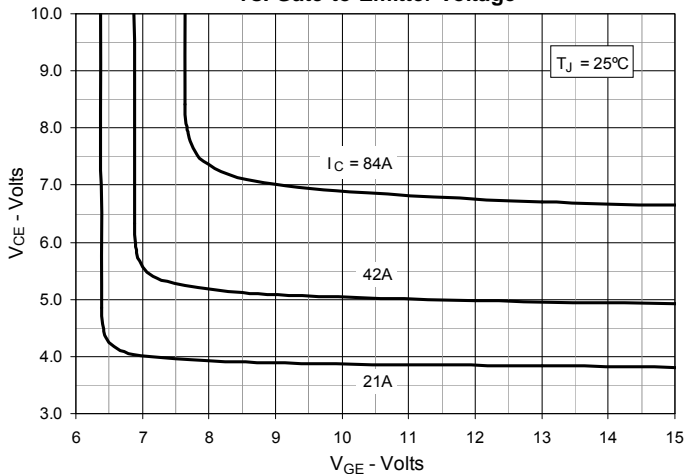

Fig. 6. Input Admittance

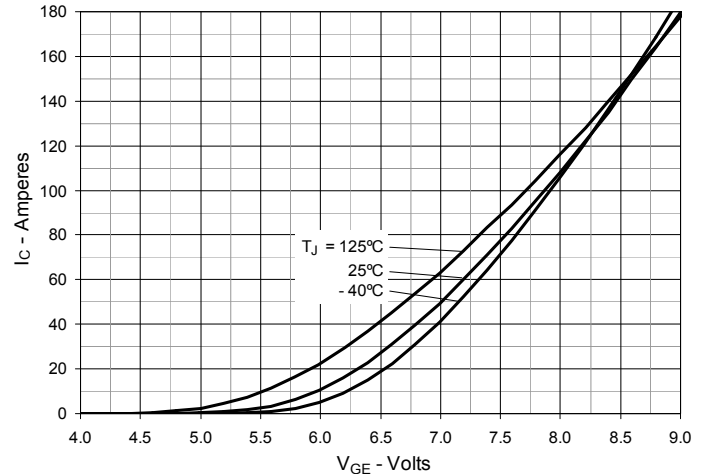

Fig. 7. Transconductance

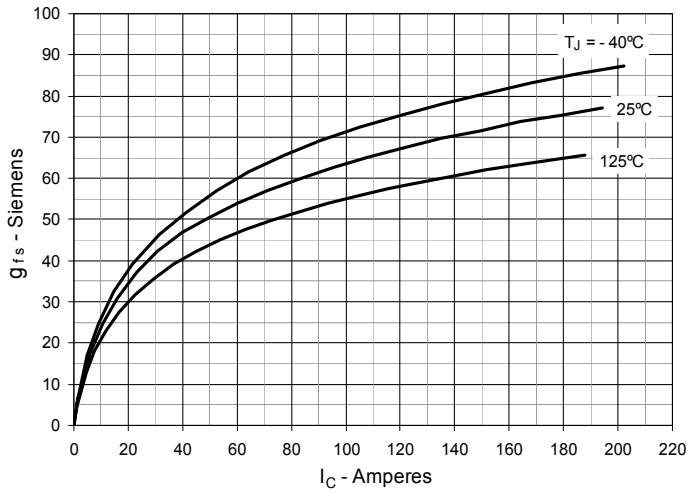

Fig. 8. Gate Charge

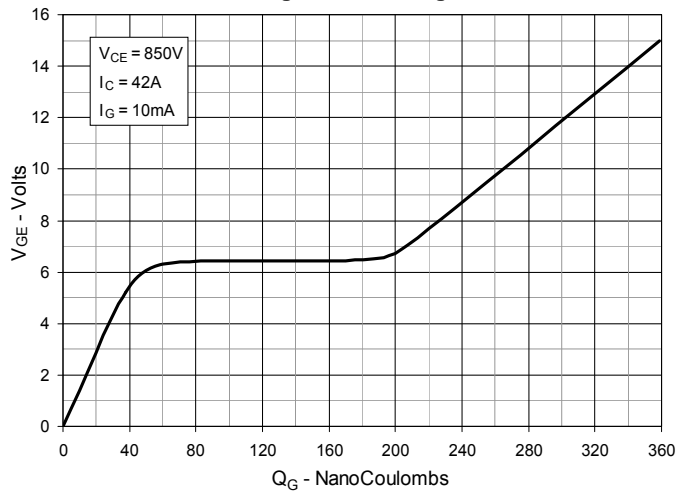

Fig. 9. Forward Voltage Drop of Intrinsic Diode

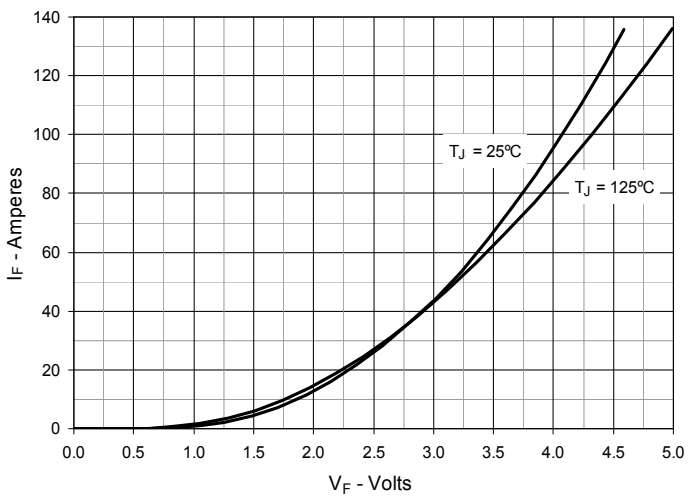

Fig. 10. Capacitance

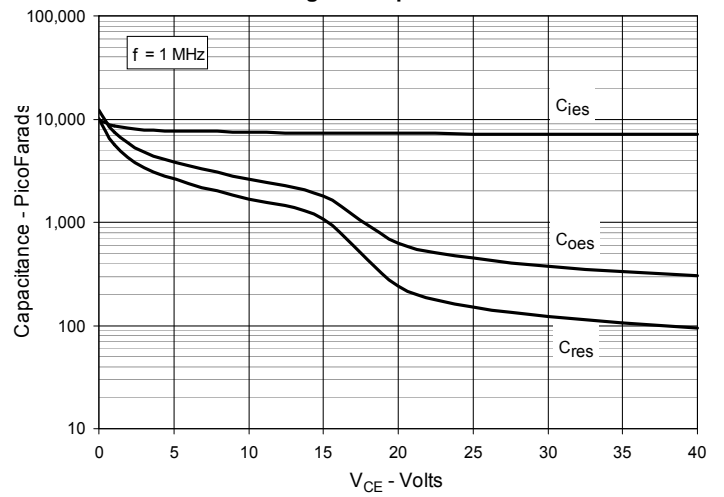

Fig. 11. Reverse-Bias Safe Operating Area

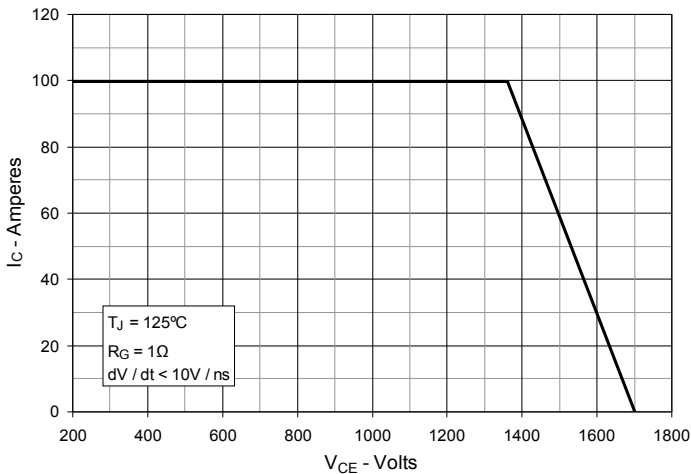

Fig. 12. Maximum Transient Thermal Impedance

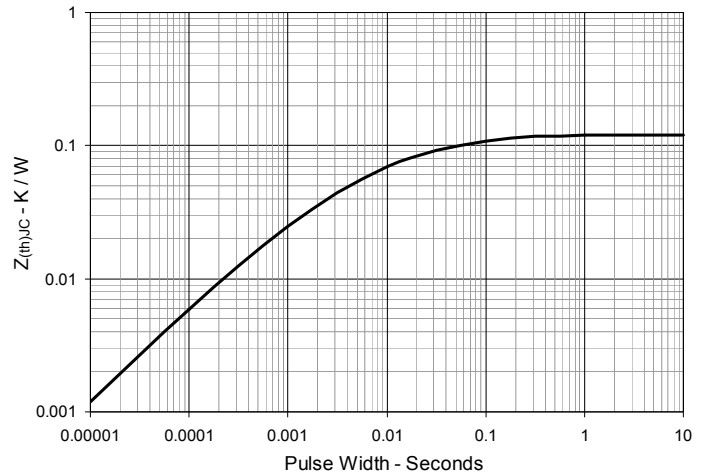

Fig. 13. Inductive Turn-off
Switching Energy Loss vs. Gate Resistance

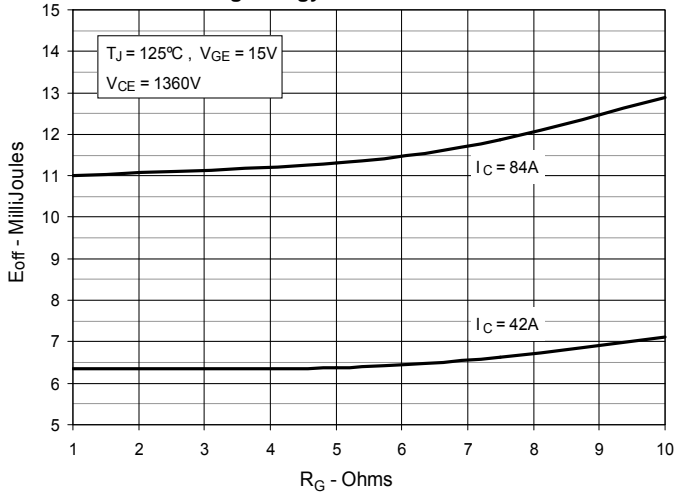

Fig. 14. Inductive Turn-off
Switching Energy Loss vs. Collector Current

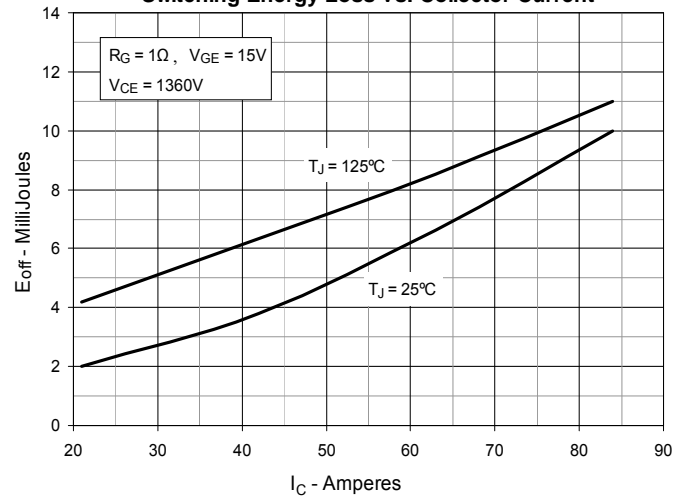

Fig. 15. Inductive Turn-off
Switching Energy Loss vs. Junction Temperature

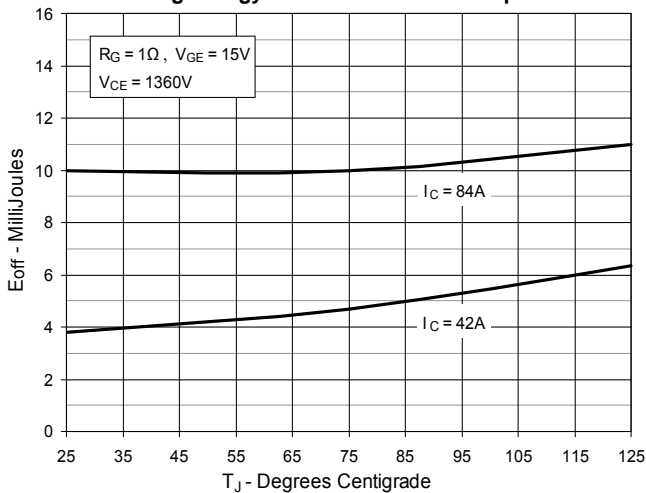

Fig. 16. Inductive Turn-off
Switching Times vs. Gate Resistance

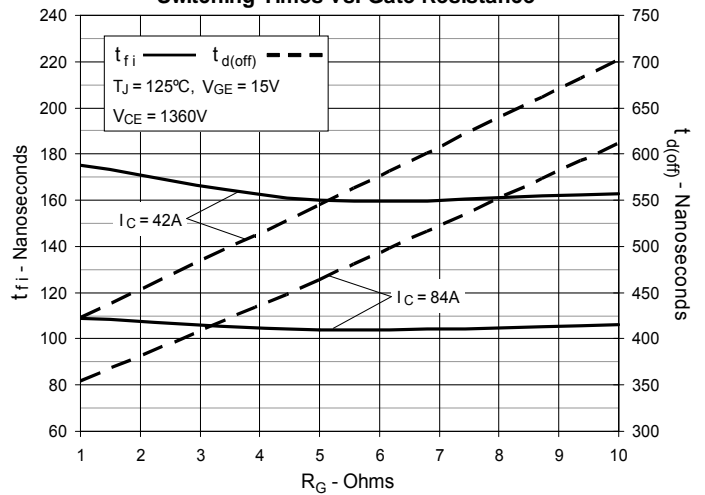

Fig. 17. Inductive Turn-off
Switching Times vs. Collector Current

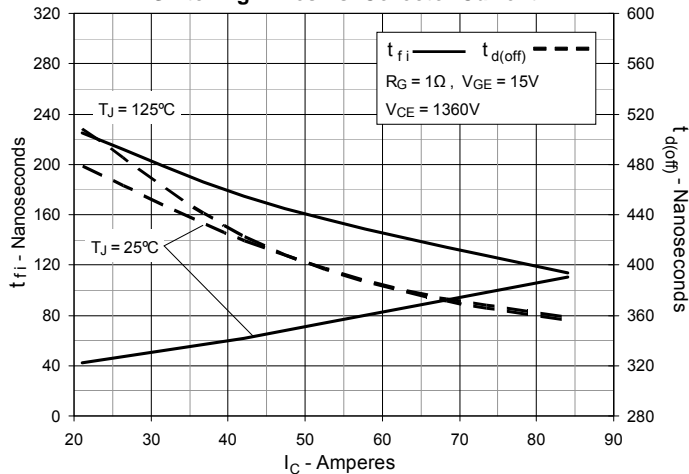
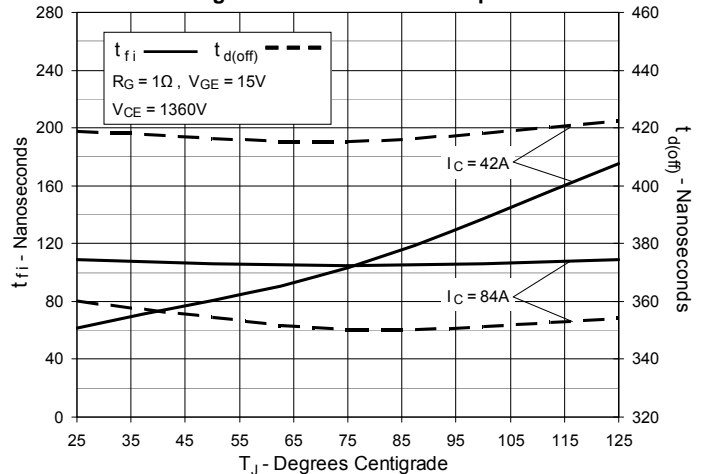
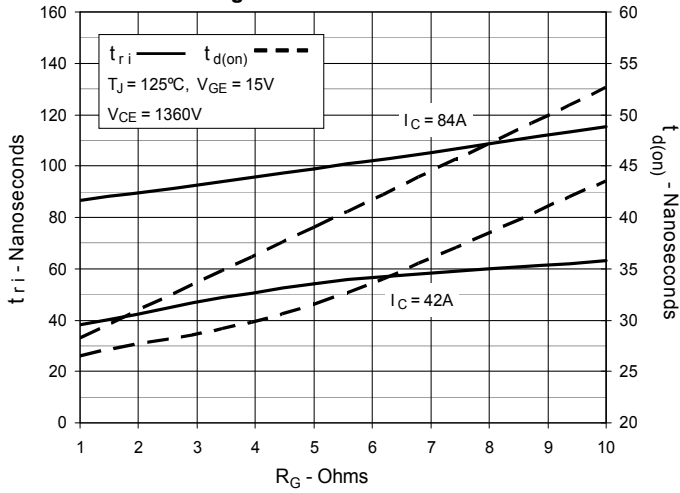

Fig. 18. Inductive Turn-off
Switching Times vs. Junction Temperature



**Fig. 19. Inductive Turn-on
Switching Times vs. Gate Resistance**



**Fig. 20. Inductive Turn-on
Switching Times vs. Collector Current**

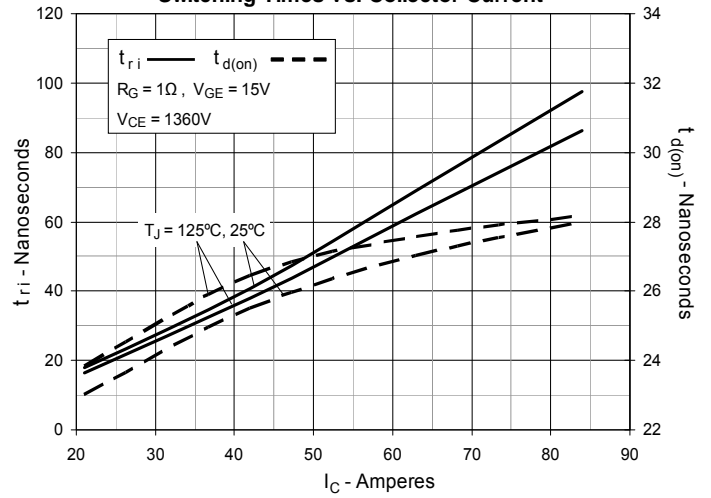

**Fig. 21. Inductive Turn-on
Switching Times vs. Junction Temperature**

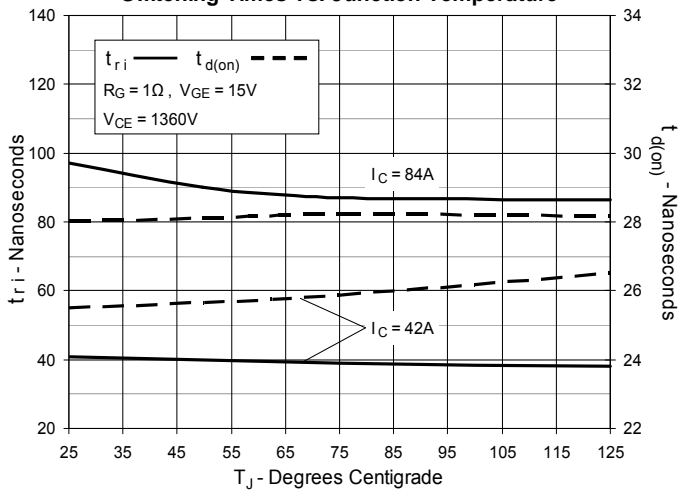



Disclaimer Notice - Information furnished is believed to be accurate and reliable. However, users should independently evaluate the suitability of and test each product selected for their own applications. Littelfuse products are not designed for, and may not be used in, all applications. Read complete Disclaimer Notice at www.littelfuse.com/disclaimer-electronics.