



IXYS
A Littelfuse Technology

Power Semiconductor 2020 - 2021 Product Catalog

A guide to selecting the right power semiconductor for your applications



About Littelfuse

Littelfuse products are vital components in applications that use electrical energy, from consumer electronics to vehicles and industrial facilities. Our history of innovation and technical expertise enable us to provide objective, comprehensive, and personalized customer solutions.

In 2018, Littelfuse acquired IXYS Corporation and created the IXYS: A Littelfuse Technology brand, which represents the company's comprehensive portfolio of advanced power semiconductor technologies, including silicon carbide and wide band gap solutions in discrete and module packages. These power semiconductor products make up one of the broadest portfolios used by power electronics design engineers today, consisting of rectifiers, fast diodes, MOSFETs, IGBTs, SSRs, and thyristors at various ratings in discrete outlines and in integrated power modules with the necessary driver IC devices.

IXYS: A Littelfuse Technology provides a core platform for serving a wide range of applications to improve power conversion efficiency, generate clean energy, power data and communications networks, control motors, facilitate automation, improve medical equipment, and electrify transportation from bikes to cars to buses to trains to ships. Littelfuse power semiconductors are relied upon in the most strenuous environments on the planet.

From a technology standpoint, the integration of IXYS and Littelfuse portfolios creates a rare broad base supplier of high quality power semiconductors. Not only has Littelfuse taken steps, such as its IXYS acquisition, to reinforce its footprint in the power semiconductor industry, it has also invested heavily in the development and commercialization of emerging technologies such as silicon carbide. In 2015, Littelfuse invested in and later acquired Monolith Semiconductor Inc., a Texas-based start-up company developing silicon carbide power devices for broad application usage. This technology adds another key option for power electronics designers to optimize their designs for energy efficiency, power density, and reduced system level costs.

Littelfuse boasts a proud track record of customer satisfaction, manufacturing excellence, and stable growth; much of which can be traced to deep roots as a world leader in circuit protection. Having the determination to integrate such important capabilities in power semiconductor technology demonstrates why Littelfuse is, and will continue to be, an industry innovator and high service supplier for its power electronics customers.

	Page		Page	
General		Rectifier Bridges		
Contents, Certified Management Systems	I	Rectifier Bridges with Fast Diodes	105	
Alphanumeric Index	III	1~ Rectifier Bridges	106	
Symbols and Terms, Nomenclature	XXIII	1~ Rectifier Bridges, half controlled	107	
IXYS Milpitas / Lampertheim		3~ Rectifier Bridges	108	
New Pressfit Pin packages	1	3~ Rectifier Bridges with Brake Unit	111	
High Voltage TO-252 / 263 / 268 / 247 & ISO247 package	2	3~ Rectifier Bridges, half controlled	112	
New TO-247-4L package	7	AC Controller / Triac	113	
ISOPLUS™ family	8	1~ / 3~ High Voltage Rectifiers	115	
ISOPLUS-SMPD™	9	Braking Rectifier Assemblies	115	
ISOPLUS-DIL™ / ISOPLUS i4-PAC™	14	Protection Devices		
IGBT Discretes		116		
Ignition IGBTs and Relevant Peripheral Components	20	Break-Over Diodes (BOD)	116	
600V / 650V / 900V / 1700V & 2500V XPT™	22	Fast Break-Over Diodes (BOD)	118	
1200V XPT™ / X2PT™ / NPT / PT IGBTs	28	Littelfuse		
High Voltage Types 1700V up to 4500V	30	Ignition IGBTs and relevant peripheral components	20	
BiMOSFETs (reverse conducting) 1600V up to 3600V	32	SiC products	71	
IGBT Modules		34	Thyristors	92
Phase Leg / CBI Modules	34	Triac	114	
6-Pack Modules	36	IXYS Beverly		
Half Bridge and Boost Modules in SimBus F Housing	38	Gate Drivers & Power Relays		
Full Bridge and Brake / Buck / Boost Modules	39	119		
Half Bridge Modules in 34/62mm housings	40	IXYS Chippenham		
Power MOSFETs		41	Application Notes & Technical Information	137
Trench MOSFETs / HiPerFETs (Fast Body Diode)	43	Rectifier Diodes & Standard base clamp kits	138	
TrenchT2™ / T3™ / T4™ MOSFETs / HiPerFETs (FBD)	45	Fast Recovery Diodes	145	
Polar™ MOSFETs / HiPerFETs (FBD)	48	Soft Recovery Diodes	147	
PolarP2™/ P3™ MOSFETs / HiPerFETs (FBD)	54	Extra Fast Recovery Diodes	150	
X4, X3, X2 & X-Class Ultra Junction Power MOSFETs	56	High Power Sonic FRD's	151	
Q3-Class HiPerFET (Fast Body Diode)	63	Phase Control Thyristors	152	
Very High Voltage (up to 4700V) / Legacy MOSFETs	64	Medium Voltage Thyristors	158	
Linear L2™ Power MOSFETs	66	Fast Turn-Off Thyristors	160	
Depletion-Mode MOSFETs (normally on)	67	Distributed Gate Thyristors	162	
PolarP™ and TrenchP™ P-channel MOSFETs	68	Asymmetric and Pulse Thyristors	167	
Superjunction Power MOSFETs	70	GTOs	168	
SiC MOSFETs and SiC Schottky Diodes	71	Insulated Gate Bi-polar Transistors - <i>Press-Pack IGBTs</i>	169	
MOSFET Modules	74	Press-Pack IGBT Gate Drive Units	172	
Power Factor Correction Modules	75	Dual Thyristor /Single Thyristor Modules	173	
Diodes		76	Thyristor / Diode Modules	175
Schottky Gen ² Diodes	77	Dual & Single Diode Modules	177	
Schottky Diodes	79	Water Cooled Diode & Thyristor Modules	179	
HiPerDyn™ FREDs & Dual Ultrafast Diodes	80	Power Semiconductor Assemblies	180	
HiPerFRED2™ & HiPerFRED™ Diodes	81	Westack - Modular Solutions	183	
SONIC-FRD™ Diodes	83	WestackLITE - Modular Solutions	185	
FRED Diodes	84	Power Semiconductor Accessories	187	
FRED & HiPerFRED™ Modules & Semifast Diodes	86	Bar Clamps / Box Clamps	188	
Rectifier & Avalanche Types	87	Heatsinks / Coolers	193	
Studs: Rectifier & Avalanche Diodes & Thyristors	89	Power Semiconductor Chips @ DCB Ceramic Substrates		
Rectifier Diode Modules	94, 177	195		
Thyristors		90	Application Notes Highlights	
Discretes Phase Control Thyristors	91	196		
Thyristor / Diode Modules	93, 97, 175	Outline Drawings		
Thyristor Modules	100, 173	IXYS Chippenham	O-01	
Accessories & Design Information	104	IXYS Milpitas / Lampertheim	O-36	
		Littelfuse	O-60	

<p>IXYS Milpitas USA</p>	<p>ISO 9001:2015</p>	<p>Quality Management System</p>
<p>IXYS Beverly USA</p>	<p>ISO 9001:2015</p>	<p>Quality Management System</p>
<p>IXYS Lampertheim Germany</p>	<p>IATF 16949:2016 (includes ISO 9001:2015)</p> <p>DIN EN ISO 14001:2015</p> <p>OHSAS 18001:2007</p> <p>DIN EN ISO 50001:2011</p>	<p>Quality Management System IATF 16949:2016</p> <p>Environmental Management System</p> <p>Occupational Safety Assessment System</p> <p>Energy Management System</p>
<p>IXYS Chippenham UK</p>	<p>ISO 9001:2015</p> <p>EN ISO 14001:2015</p>	<p>Quality Management System</p> <p>Environmental Management System</p>

Alphanumeric Index

> New
 ○ Not for new design
 ◇ Under development

IXYS Milpitas/Lampertheim Littelfuse Power

0440 005.WRA	21	CMA 80MT1600NHB	113	DHG 10I600PM	83	DMA 200X1600NA	88
0440 007.WRA	21	CMA 80MT1600NHR	6, 113	DHG 10I1200PA	83	DMA 200XA1600NA	88
0440 008.WRA	21	CMA 80PD1600NA	97	DHG 10I1200PM	83	DMA 200YA1600NA	110
C		CME 30E1600PZ	3, 91	DHG 10I1800PA	83	DMA 200YC1600NA	110
CLA 5E1200PZ	3, 90	CNE 60E2200TZ	5, 91	> DHG 10IM1800UZ	2, 83	DMA 240YA1600NA	110
CLA 5E1200UC	90	CS 19-08ho1	90	DHG 20C600PB	83	DMA 240YC1600NA	110
CLA 15E1200NPB	90	CS 19-08ho1S	90	DHG 20C600QB	83	DNA 30E2200FE	17, 88
CLA 15E1200NPZ	3, 90	CS 19-12ho1	90	DHG 20C1200PB	83	DNA 30E2200PA	88
CLA 16E800PN	90	CS 19-12ho1S	90	DHG 20I600HA	83	DNA 30E2200PZ	2, 88
CLA 16E1200PN	90	CS 20-12io1	90	DHG 20I600PA	83	DNA 30EM2200PZ	2, 88
CLA 20EF1200PB	91	CS 20-14io1	90	DHG 20I1200HA	83	DNA 30ER2200IY	88
CLA 20EF1200PZ	3, 91	CS 20-16io1	90	DHG 20I1200PA	83	DNA 40U2200GU	108
CLA 30E1200HB	90	CS 20-22moF1	17, 90	DHG 30I600HA	83	DNA 90U2200LB	109
CLA 30E1200NPZ	3, 90	CS 20-25mo1F	17, 90	DHG 30I600PA	83	DNA 90YA2200NA	110
CLA 30E1200PB	90	CS 20-25moT1	90	DHG 30I1200HA	83	DNA 90YC2200NA	110
CLA 30E1200PC	90	CS 22-08io1M	90	DHG 30IM600PC	83	DNA 120E2200KO	88
CLA 30MT1200NPB	113	CS 22-12io1M	90	> DHG 40B1200LB	13, 105	DPF 30I300PA	81
CLA 30MT1200NPZ	3, 113	○ CS 23-08io2	89	DHG 40C600HB	83	DPF 30P600HR	6, 80
CLA 40E1200HR	6, 90	○ CS 23-12io2	89	DHG 40C1200HB	83	DPF 60C200HB	81
CLA 40E1200NHB	90	○ CS 23-16io2	89	DHG 40I4500KO	83	DPF 60C200HJ	81
CLA 40E1200NPZ	3, 90	CS 30-12io1	90	DHG 50X650NA	83	DPF 60C300HB	81
> CLA 40MT1200NHB	113	CS 30-14io1	90	DHG 50X1200NA	83	DPF 60I200HA	81
CLA 40MT1200NHR	6, 113	CS 30-16io1	90	DHG 55I3300FE	83	DPF 60IM400HB	81
CLA 40MT1200NPB	113	○ CS 35-08io4	89	DHG 60C600HB	83	DPF 80C200HB	81
CLA 40MT1200NPZ	3, 113	○ CS 35-12io4	89	DHG 60I600HA	83	DPF 240X200NA	81
CLA 40P1200FC	17, 90	○ CS 35-14io4	89	DHG 60I1200HA	83	DPF 240X400NA	81
CLA 50E1200HB	91	CS 45-08io1	91	DHG 60U1200LB	13, 105	DPG 10I200PA	81
CLA 50E1200TC	91	CS 45-12io1	91	DHG 100X650NA	83	DPG 10I200PM	81
CLA 60MT1200NHB	113	CS 45-16io1	91	DHG 100X1200NA	83	DPG 10I300PA	81
CLA 60MT1200NHR	6, 113	CS 45-16io1R	91	DHH 55-36N1F	17, 80, 83	DPG 10I400PA	81
CLA 60MT1200NTZ	5, 113	CS 60-12io1	91	DLA 5P800UC	87	DPG 10I400PM	81
◇ CLA 60MU1200LB	13	CS 60-14io1	91	DLA 10IM800UC	87	DPG 10IM300UC	81
CLA 60PD1200NA	97	CS 60-16io1	91	DLA 20IM800PC	87	DPG 10P400PJ	80, 81
CLA 80E1200HF	91	> CS 60-16io1R	91	DLA 40IM800PC	88	DPG 15I200PA	81
CLA 80MT1200NHB	113	D		DLA 60I1200HA	88	DPG 15I300PA	81
CLA 80MT1200NHR	6, 113	DAA 10EM1800PZ	2, 87	DLA 100B800LB	13, 75, 107	DPG 15I400PM	81
CLA 100E1200HB	91	DAA 10P1800PZ	2, 87	DLA 100B1200LB	13, 75, 107	DPG 20C200PB	81
CLA 100E1200KB	91	DAA 200X1800NA	88	> DLA 100IM1200TZ	5, 88	DPG 20C200PN	81
> CLA 100E1200TZ	5, 90, 91	DAA 200XA1800NA	88	DMA 10I1600PA	87	DPG 20C300PB	81
CLA 100PD1200NA	98	> DCG 10P1200HR	6, 73	DMA 10IM1200UZ	2, 87	DPG 20C300PN	81
CLA 110MB1200NA	113	> DCG 17P1200HR	6, 73	DMA 10IM1600PZ	2, 87	DPG 20C400PB	81
CLB 30I1200HB	90	> DCG 20B650LB	13, 73, 105	DMA 10IM1600UZ	2, 87	DPG 20C400PC	81
CLB 30I1200PZ	3, 90	◇ DCG 20B1200LB	13, 73, 105	DMA 10P1200HR	6, 87	DPG 20C400PN	81
CLB 40I1200PZ	3, 90	> DCG 20C1200HR	6, 73	DMA 10P1200UZ	2, 87	DPG 30C200HB	81
CLE 20E1200PC	91	> DCG 35C1200HR	6, 73	DMA 10P1600HR	6, 87	DPG 30C200PB	81
CLE 30E1200PB	91	◇ DCG 40X1200LB	13, 73	DMA 10P1600PZ	2, 87	DPG 30C200PC	81
CLE 40E1200HB	91	DCG 45X1200NA	73	DMA 10P1600UZ	2, 87	DPG 30C300HB	81
CLE 90UH1200TLB	91, 112	DCG 85X1200NA	73	DMA 10P1800PZ	2, 87	DPG 30C300PB	81
CLF 20E1200PB	91	DCG 100X1200NA	73	DMA 30E1800HA	88	DPG 30C300PC	81
CMA 20E1600PB	90	DCG 130X1200NA	73	DMA 30IM1600PZ	2, 88	DPG 30C400HB	81
CMA 20E1600PZ	3, 90	> DCG 160X650NA	73	DMA 30P1200HB	88	DPG 30C400PB	81
CMA 30E1600PB	90	DFE 10I600PM	84	DMA 30P1600HB	88	DPG 30I300HA	81
CMA 30E1600PN	90	DFE 25I600HA	84	DMA 30P1600HR	6, 88	DPG 30I300PA	81
CMA 30E1600PZ	3, 90	DFE 240X600NA	85	DMA 40U1800GU	108	DPG 30I400HA	81
CMA 30P1600FC	17, 90	> DFE 250X600NA	85	DMA 50I800HA	88	DPG 30I600PM	82
CMA 40E1600HR	6, 90	DH 20-18A	83	DMA 50I1200HA	88	DPG 30IM300PC	81
CMA 50E1600HB	91	DH 40-18A	83	DMA 50I1600HA	88	DPG 30IM400PC	81
CMA 50E1600QB	91	DH 60-14A	83	DMA 50P1200HB	88	DPG 30P300PJ	80, 81
CMA 50E1600TZ	5, 91	DH 60-16A	83	DMA 50P1200HR	6, 88	DPG 30P400PJ	80, 81
CMA 50P1600FC	17, 91	DH 2x60-18A	83	DMA 50P1600HB	88	DPG 60B600LB	13, 105
◇ CMA 50P1600LB	13	DH 60-18A	83	DMA 80IM1600HB	88	DPG 60C200HB	81
CMA 60MT1600NHB	113	DH 2x61-18A	83	DMA 90U1800LB	13, 109	DPG 60C200QB	81
CMA 60MT1600NHR	6, 113	DHG 5I600PA	83	> DMA 120B800LB	13, 75, 107	DPG 60C300HB	81
CMA 80E1600HB	91	DHG 5I600PM	83	DMA 150E1600NA	88	DPG 60C300HJ	81
		DHG 10C600PB	83	DMA 150YA1600NA	110	DPG 60C300PC	81
		DHG 10I600PA	83	DMA 150YC1600NA	110	DPG 60C300QB	81

Alphanumeric Index

- New
- Not for new design
- ✦ Under development

DPG 60C400HB	81	DSA 60C45HB	77	DSEC 120-12AK	82	DSEP 12-12B	82
DPG 60C400QB	81	DSA 60C45PB	77	DSEC 240-04A	82	DSEP 12-12BZ	2, 82
DPG 60I300HA	81	DSA 60C60HB	77	DSEC 240-06A	82	DSEP 15-06A	82
DPG 60I400HA	81	DSA 60C60PB	77	DSEE 15-12CC	80	DSEP 15-06AS	82
DPG 60IM300PC	81	DSA 60C100PB	77	DSEE 29-12CC	80	DSEP 15-06B	82
DPG 60IM400QB	81	DSA 60C150PB	78	DSEE 30-12A	80	DSEP 15-06BS	82
DPG 80C300HB	81	DSA 70C100HB	77	DSEE 55-24N1F	17, 80	DSEP 15-12CR	80
DPG 80C400HB	81	DSA 70C150HB	78	DSEI 8-06A	84	DSEP 2x25-12C	80
DPG 120C300QB	81	DSA 70C200HB	78	DSEI 8-06AS	84	DSEP 29-06A	82
DPH 30IS600HI	80, 81	○ DSA 75-12B	89	DSEI 12-06A	84	DSEP 29-06AS	82
DPJ 50XS1800NA	80	○ DSA 75-16B	89	DSEI 12-06AS	84	DSEP 29-06B	82
○ DS 2-12A	89	○ DSA 75-18B	89	DSEI 12-10A	84	DSEP 29-12A	82
○ DS 17-12A	89	DSA 80C45HB	77	DSEI 12-12A	84	DSEP 29-12B	82
○ DS 35-12A	89	DSA 80C100PB	77	DSEI 12-12AZ	2, 84	DSEP 30-06A	82
○ DS 75-12B	89	DSA 90C200HB	78	DSEI 19-06AS	84	DSEP 30-06B	82
DSA 1-12D	87	DSA 90C200HR	6, 78	DSEI 20-12A	84	DSEP 30-06BR	82
DSA 1-16D	87	DSA 120C150QB	78	DSEI 25-06A	84	DSEP 30-12A	82
DSA 1-18D	87	DSA 120X150LB	13, 78	DSEI 25-06AS	84	DSEP 30-12AR	82
○ DSA 2-12A	89	DSA 120X200LB	13, 78	DSEI 2x30-04C	85	DSEP 30-12B	82
○ DSA 2-16A	89	DSA 240X150NA	78	DSEI 30-06A	84	DSEP 30-12CR	80
○ DSA 2-18A	89	✦ DSA 240X200LB	13, 78	DSEI 2x30-06C	85	DSEP 2x31-03A	82
○ DSA 9-12F	89	DSA 240X200NA	78	DSEI 30-10A	84	DSEP 2x31-06A	82
○ DSA 9-16F	89	DSA 300I45NA	77	DSEI 30-10AR	84	DSEP 2x31-06B	82
○ DSA 9-18F	89	DSA 300I100NA	77	DSEI 2x30-10B	85	DSEP 2x31-12A	82
DSA 10C150PB	78	DSA 300I200NA	78	DSEI 30-12A	84	DSEP 40-03AS	82
DSA 10C150UC	78	○ DSAI 17-12A	89	DSEI 2x30-12B	85	DSEP 60-06A	82
DSA 10I100PM	77	○ DSAI 17-16A	89	DSEI 2x31-04C	85	DSEP 60-06AT	82
DSA 10IM100UC	77	○ DSAI 17-18A	89	DSEI 2x31-06C	85	DSEP 2x60-12A	82
DSA 15I45PA	77	○ DSAI 35-12A	89	DSEI 2x31-10B	85	DSEP 60-12A	82
DSA 15IM45IB	77	○ DSAI 35-16A	89	DSEI 2x31-12B	85	DSEP 60-12AR	82
DSA 15IM45UC	77	○ DSAI 35-18A	89	DSEI 36-06AS	84	DSEP 60-12AZ	5, 82
DSA 15IM150UC	78	○ DSAI 75-12B	89	DSEI 60-02A	84	DSEP 60-12B	82
DSA 15IM200UC	78	○ DSAI 75-16B	89	DSEI 2x60-04C	85	DSEP 2x61-03A	82
○ DSA 17-12A	89	○ DSAI 75-18B	89	DSEI 60-06A	84	DSEP 2x61-06A	82
○ DSA 17-16A	89	DSB 10I45PM	77	DSEI 60-10A	84	DSEP 2x61-12A	82
○ DSA 17-18A	89	DSB 15IM30UC	77	DSEI 60-12A	84	DSEP 2x61-12B	82
DSA 20C45PB	77	DSB 15IM45IB	77	DSEI 2x61-02A	85	DSEP 75-06AR	82
➤ DSA 20C60PB	77	DSB 20C60PN	77	DSEI 2x61-04C	85	DSEP 90-12AZ	5, 82
DSA 20C60PN	77	DSB 20I15PA	77	DSEI 2x61-06C	85	DSEP 2x91-03A	82
DSA 20C100PB	77	DSB 30C30PB	77	DSEI 2x61-06P	85	DSEP 2x91-06A	82
DSA 20C100PN	77	DSB 30C45HB	77	DSEI 2x61-10B	85	DSEP 2x101-04A	82
DSA 20C150PB	78	DSB 30C45PB	77	DSEI 2x61-12B	85	○ DSI 17-12A	89
DSA 20C150PN	78	DSB 30C60PB	77	DSEI 2x61-12P	85	DSI 30-08A	87
DSA 20C200PB	78	DSB 40C15PB	77	DSEI 2x101-06A	85	DSI 30-08AS	87
DSA 30C45HB	77	DSB 60C30HB	77	DSEI 2x101-06P	85	DSI 30-12A	87
DSA 30C45PB	77	DSB 60C30PB	77	DSEI 2x101-12A	85	DSI 30-12AS	87
DSA 30C45PC	77	DSB 60C45HB	77	DSEI 2x101-12P	85	DSI 30-16A	87
DSA 30C60PB	77	DSB 60C45PB	77	DSEI 120-06A	84	DSI 30-16AS	87
DSA 30C100HB	77	DSB 60C60HB	77	DSEI 120-12A	84	○ DSI 35-12A	89
DSA 30C100PB	77	DSB 60C60PB	77	➤ DSEI 120-12AZ	5, 84	DSI 45-08A	88
DSA 30C100PN	77	DSB 80C45HB	77	DSEI 2x121-02A	85	DSI 45-12A	88
DSA 30C100QB	77	DSDI 60-14A	86	DSEI 2x161-02P	85	DSI 45-16A	88
DSA 30C150HB	78	DSDI 60-16A	86	DSEI 2x161-06P	85	DSI 45-16AR	88
DSA 30C150PB	78	DSDI 60-18A	86	DSEI 2x161-12P	85	DSI 2x55-12A	88
DSA 30C150PC	78	DSEC 16-06A	82	DSEK 60-02A	84	DSI 2x55-16A	88
DSA 30C200IB	78	DSEC 16-06AC	82	DSEK 60-02AR	84	○ DSI 75-12B	89
DSA 30C200PB	78	DSEC 16-12A	82	DSEK 60-06A	84	DSIK 45-16AR	88
DSA 30C200PC	78	DSEC 16-12AS	82	DSEK 60-12A	84	DSP 8-08A	87
DSA 30I100PA	77	DSEC 29-06AC	82	DSEK 300-06A	85	DSP 8-08AS	87
DSA 30I150PA	78	DSEC 30-06A	82	DSEP 6-06AS	82	DSP 8-08S	87
○ DSA 35-12A	89	DSEC 30-06B	82	DSEP 6-06BS	82	DSP 8-12A	87
○ DSA 35-16A	89	DSEC 30-12A	82	DSEP 8-06A	82	DSP 8-12AS	87
○ DSA 35-18A	89	DSEC 59-06BC	82	DSEP 8-06B	82	DSP 8-12S	87
DSA 50C100HB	77	DSEC 60-06A	82	DSEP 8-12A	82	DSP 25-12A	87
DSA 50C100QB	77	DSEC 60-06B	82	DSEP 12-12A	82	DSP 25-12AT	87
DSA 50C150HB	78	DSEC 60-12A	82	DSEP 12-12AZ	2, 82	DSP 25-16A	87

Alphanumeric Index

> New
 ○ Not for new design
 ◇ Under development

DSP 25-16AR	87	DSSK 70-003B	79	IXA 40RG1200DHGLB	12	IXBOD 1-22R	116
DSP 25-16AT	87	DSSK 70-008A	79	IXA 45IF1200HB	28	IXBOD 1-22RD	116
DSP 45-12A	88	DSSK 70-008AR	79	IXA 55I1200HJ	28	IXBOD 1-23R	116
DSP 45-12AZ	5, 88	DSSK 80-0008D	79	IXA 60IF1200NA	28	IXBOD 1-23RD	116
DSP 45-16A	88	DSSK 80-0025B	79	IXA 70I1200NA	28	IXBOD 1-24R	116
DSP 45-16AR	88	DSSK 80-003B	79	IXA 70R1200NA	28	IXBOD 1-24RD	116
DSP 45-16AZ	5, 88	DSSK 80-0045B	79	IXBA 10N300HV	3, 33	IXBOD 1-25R	116
DSP 45-18A	88	DSSK 80-006B	79	IXBA 14N300HV	3, 33	IXBOD 1-25RD	116
DSS 6-0025BS	79	DSSK 80-006BR	79	IXBA 16N170AHV	3, 32	IXBOD 1-26R	116
DSS 6-0045AS	79	DSSS 30-01AR	79	IXBF 14N300	16, 33	IXBOD 1-26RD	116
DSS 6-015AS	80	DSSS 35-008AR	79	IXBF 16N360	16, 33	IXBOD 1-28R	116
DSS 10-0045B	79	F		IXBF 20N360	16, 33	IXBOD 1-28RD	116
DSS 10-006A	79	FBE 22-06N1	17, 105	IXBF 22N300	16, 33	IXBOD 1-30R	116
DSS 10-01A	79	FBO 16-12N	17, 75, 106	IXBF 28N300	16, 33	IXBOD 1-30RD	116
DSS 10-01AS	79	FBO 40-12N	17, 75, 106	IXBF 32N300	16, 33	IXBOD 1-32R	116
DSS 16-0045A	79	FBS 10-12SC	17, 73, 105	IXBF 42N300	16, 33	IXBOD 1-32RD	116
DSS 16-0045AS	79	FMD 15-06KC5	16, 70, 75	IXBF 50N360	16, 33	IXBOD 1-34R	116
DSS 16-01A	79	○ FMD 40-06KC	16, 70, 75	IXBF 55N300	16, 33	IXBOD 1-36R	116
DSS 16-01AS	79	FMM 22-05PF	16	IXBH 6N170	32	IXBOD 1-38R	116
DSS 17-06CR	80	FMM 22-06PF	16	IXBH 10N170	32	IXBOD 1-40R	116
DSS 20-0015B	79	FMM 50-025TF	16	IXBH 10N300	33	IXBOD 1-42R	116
DSS 20-01AC	79	FMM 60-02TF	16	IXBH 10N300HV	5, 33	IXBOD 2-01	117
DSS 25-0025B	79	○ FMM 75-01F	16	IXBH 14N300HV	5, 33	IXBOD 2-02	117
DSS 25-0045A	79	FMP 26-02P	16	IXBH 16N170	32	IXBOD 2-03	117
DSS 40-0008D	79	FMP 36-015P	16	IXBH 16N170A	32	IXBOD 2-04	117
DSS 2x41-01A	79	FMP 76-010T	16	IXBH 16N360HV	5, 33	IXBOD 2-05	117
DSS 60-0045B	79	FUE 30-12N1	17, 105	IXBH 20N360HV	5, 33	IXBOD 2-06	117
DSS 2x61-0045A	79	FUO 22-12N	17, 108	IXBH 22N300HV	5, 33	IXBOD 2-07	117
DSS 2x61-01A	79	FUO 22-16N	17, 108	IXBH 24N170	32	IXBOD 2-08	117
DSS 2x81-0045B	79	FUO 50-16N	17, 108	IXBH 32N300	33	IXBOD 2-09	117
DSS 2x101-015A	80	○ FUS 45-0045B	17, 79, 105	IXBH 32N300HV	5, 33	IXBOD 2-10	117
DSS 2x101-02A	80	G		IXBH 42N170	32	IXBOD 2-11	117
DSS 2x111-008A	79	GBO 25-12NO1	106	IXBH 42N170A	32	IXBOD 2-12	117
DSS 2x121-0045B	79	GBO 25-16NO1	106	IXBH 42N300HV	5, 33	IXBOD 2-13	117
DSS 2x160-0045A	79	GMM 3x60-015X2	14	IXBK 55N300	33	IXBOD 2-14	117
DSS 2x160-01A	79	GUO 40-08NO1	108	IXBK 64N250	32	IXBOD 2-15R	117
DSS 2x200-0008D	79	GUO 40-12NO1	108	IXBK 75N170	32	IXBOD 2-15RD	117
DSSK 10-018A	80	GUO 40-16NO1	108	IXBL 60N360	33	IXBOD 2-16R	117
DSSK 16-01A	79	I		IXBL 64N250	32	IXBOD 2-16RD	117
DSSK 16-01AS	79	> ITF 40PF1200DHGTLB	12	IXBN 42N170A	32	IXBOD 2-17R	117
DSSK 18-0025BS	79	◇ ITF 40PG1200DHGLB	12	IXBN 75N170	32	IXBOD 2-17RD	117
DSSK 20-0045B	79	> ITF 48IF1200HR	7, 28	IXBOD 1-06	116	IXBOD 2-18R	117
DSSK 20-015A	80	◇ ITG 100IF1200LB	12	IXBOD 1-07	116	IXBOD 2-18RD	117
DSSK 28-0045BS	79	◇ ITG 100X1200LB	12	IXBOD 1-08	116	IXBOD 2-19R	117
DSSK 28-006BS	79	◇ ITG 100XF1200LB	12	IXBOD 1-09	116	IXBOD 2-19RD	117
DSSK 28-01AS	79	◇ IXA 4IF1200PZ	3, 28	IXBOD 1-10	116	IXBOD 2-20R	117
DSSK 30-01A	79	IXA 4IF1200TC	28	IXBOD 1-12R	116	IXBOD 2-20RD	117
DSSK 30-018A	80	IXA 4IF1200UC	28	IXBOD 1-12RD	116	IXBOD 2-21R	117
DSSK 38-0025B	79	IXA 12IF1200HB	28	IXBOD 1-13R	116	IXBOD 2-21RD	117
DSSK 38-0025BS	79	IXA 12IF1200PB	28	IXBOD 1-13RD	116	IXBOD 2-22R	117
DSSK 40-0015B	79	○ IXA 12IF1200TC	28	IXBOD 1-14R	116	IXBOD 2-22RD	117
DSSK 40-006B	79	IXA 17IF1200HJ	28	IXBOD 1-14RD	116	IXBOD 2-23R	117
DSSK 40-008B	79	IXA 20I1200PB	28	IXBOD 1-15R	116	IXBOD 2-23RD	117
DSSK 48-0025B	79	IXA 20I1200PZ	3, 28	IXBOD 1-15RD	116	IXBOD 2-24R	117
DSSK 48-003B	79	○ IXA 20IF1200HB	28	IXBOD 1-16R	116	IXBOD 2-24RD	117
DSSK 48-003BS	79	◇ IXA 20IF1200HR	7, 28	IXBOD 1-16RD	116	IXBOD 2-25R	117
DSSK 50-0025B	79	IXA 20PG1200DHGLB	12	IXBOD 1-17R	116	IXBOD 2-25RD	117
DSSK 50-01A	79	IXA 20RG1200DHGLB	12	IXBOD 1-17RD	116	IXBOD 2-26R	117
DSSK 50-015A	80	IXA 27IF1200HJ	28	IXBOD 1-18R	116	IXBOD 2-26RD	117
DSSK 60-0045A	79	◇ IXA 30IF1200HR	7, 28	IXBOD 1-18RD	116	IXBOD 2-27R	117
DSSK 60-0045B	79	IXA 30PG1200DHGLB	12	IXBOD 1-19R	116	IXBOD 2-27RD	117
DSSK 60-015A	80	IXA 30RG1200DHGLB	12	IXBOD 1-19RD	116	IXBOD 2-28R	117
DSSK 60-015AR	80	IXA 33IF1200HB	28	IXBOD 1-20R	116	IXBOD 2-28RD	117
DSSK 60-02A	80	IXA 37IF1200HJ	28	IXBOD 1-20RD	116	IXBOD 2-29R	118
DSSK 60-02AR	80	◇ IXA 40IF1200HR	7, 28	IXBOD 1-21R	116	IXBOD 2-29RD	118
DSSK 70-0015B	79	IXA 40PG1200DHGLB	12	IXBOD 1-21RD	116	IXBOD 2-30R	118

Alphanumeric Index

- New
- Not for new design
- ✦ Under development

IXBOD 2-30RD	118	○ IXDR 30N120D1	28	IXFB 150N65X2	60	IXFH 56N30X3	58
IXBOD 2-31R	118	IXEL 40N400	31	IXFB 170N30P	50	IXFH 60N50P3	55
IXBOD 2-31RD	118	IXFA 4N85X	61	IXFB 210N20P	50	IXFH 60N65X2	60
IXBOD 2-32R	118	IXFA 4N100P	53	IXFB 210N30P3	54	IXFH 60N65X2-4	60
IXBOD 2-32RD	118	IXFA 5N100P	53	IXFB 300N10P	50	IXFH 69N30P	50
IXBOD 2-33R	118	IXFA 6N120P	53	IXFH 5N100P	53	IXFH 70N20Q3	63
IXBOD 2-33RD	118	IXFA 7N80P	52	IXFH 6N120P	53	IXFH 70N30Q3	63
IXBOD 2-34R	118	IXFA 7N100P	53	IXFH 7N100P	53	IXFH 72N30X3	58
IXBOD 2-34RD	118	IXFA 8N65X2	60	IXFH 10N80P	52	IXFH 74N20P	50
IXBOD 2-35R	118	IXFA 8N85XHV	3, 61	IXFH 10N100P	53	IXFH 80N25X3	57
IXBOD 2-35RD	118	IXFA 10N60P	51	IXFH 12N65X2	60	IXFH 80N65X2	60
IXBOD 2-36R	118	IXFA 10N80P	52	IXFH 12N80P	52	IXFH 80N65X2-4	60
IXBOD 2-36RD	118	IXFA 12N50P	51	IXFH 12N90P	52	IXFH 86N30T	44
IXBOD 2-37R	118	IXFA 12N65X2	60	IXFH 12N100P	53	IXFH 88N30P	50
IXBOD 2-37RD	118	IXFA 14N60P	51	IXFH 12N120P	53	IXFH 90N20X3	56
IXBOD 2-38R	118	IXFA 14N60P3	55	IXFH 14N60P	51	IXFH 94N30P3	54
IXBOD 2-38RD	118	IXFA 14N85XHV	3, 61	IXFH 14N60P3	55	IXFH 94N30T	44
IXBOD 2-39R	118	IXFA 16N50P	51	IXFH 14N80P	52	IXFH 96N15P	50
IXBOD 2-39RD	118	IXFA 16N50P3	54	IXFH 14N85X	61	IXFH 96N20P	50
IXBOD 2-40R	118	IXFA 16N60P3	55	IXFH 15N100P	53	IXFH 100N25P	50
IXBOD 2-40RD	118	IXFA 18N65X2	60	IXFH 15N100Q3	63	IXFH 100N30X3	58
IXBOD 2-41R	118	IXFA 20N50P3	54	IXFH 16N50P	51	IXFH 102N15T	44
IXBOD 2-41RD	118	IXFA 20N85XHV	3, 61	IXFH 16N50P3	54	IXFH 110N10P	50
IXBOD 2-42R	118	IXFA 22N60P3	55	IXFH 16N60P3	55	IXFH 110N15T2	46
IXBOD 2-42RD	118	IXFA 22N65X2	60	IXFH 16N80P	52	IXFH 110N25T	44
IXBOD 2-43R	118	IXFA 26N30X3	58	IXFH 16N120P	53	IXFH 120N15P	50
IXBOD 2-44R	118	IXFA 26N50P3	55	IXFH 18N60P	51	IXFH 120N20P	50
IXBOD 2-45R	118	IXFA 30N25X3	57	IXFH 18N65X2	60	IXFH 120N25T	44
IXBOD 2-46R	118	IXFA 34N65X2	60	IXFH 18N90P	52	IXFH 120N25X3	57
IXBOD 2-47R	118	IXFA 36N20X3	56	IXFH 18N100Q3	63	IXFH 120N30X3	58
IXBOD 2-48R	118	IXFA 36N30P3	54	IXFH 20N50P3	54	IXFH 140N10P	50
IXBOD 2-49R	118	IXFA 38N30X3	58	IXFH 20N80P	52	IXFH 140N20X3	56
IXBOD 2-50R	118	IXFA 44N25X3	57	IXFH 20N85X	61	IXFH 150N15P	50
IXBOD 2-51R	118	IXFA 50N20X3	56	IXFH 20N100P	53	IXFH 150N17T2	46
IXBOD 2-52R	118	IXFA 56N30X3	58	IXFH 22N50P	51	IXFH 150N20T	44
IXBOD 2-53R	118	IXFA 60N25X3	57	IXFH 22N60P	51	IXFH 150N25X3	57
IXBOD 2-54R	118	IXFA 72N20X3	56	IXFH 22N60P3	55	IXFH 150N30X3	58
IXBOD 2-55R	118	IXFA 72N30X3	58	IXFH 22N65X2	60	IXFH 160N15T	44
IXBOD 2-56R	118	IXFA 76N15T2	46	IXFH 24N80P	52	IXFH 160N15T2	46
IXBR 42N170	32	IXFA 80N25X3	57	IXFH 24N90P	52	IXFH 170N10P	50
IXBT 6N170	32	IXFA 90N20X3	56	IXFH 26N50P	51	IXFH 170N25X3	57
IXBT 10N170	32	IXFA 102N15T	44	IXFH 26N50P3	55	IXFH 180N20X3	56
IXBT 16N170	32	IXFA 110N15T2	46	IXFH 26N60P	51	IXFH 220N06T3	47
IXBT 16N170A	32	IXFA 130N10T	44	➤ IXFH 26N100X	62	IXFH 220N20X3	56
IXBT 16N170AHV	4, 32	IXFA 130N10T2	46	IXFH 28N60P3	55	IXFH 230N075T2	46
IXBT 16N360HV	4, 33	IXFA 180N10T2	46	IXFH 30N50P	51	IXFH 230N10T	44
IXBT 20N360HV	4, 33	IXFA 220N06T3	47	IXFH 30N50Q3	63	IXFH 270N06T3	47
IXBT 22N300HV	4, 33	IXFA 230N075T2	46	IXFH 30N60P	51	IXFH 320N10T2	46
IXBT 24N170	32	IXFA 270N06T3	47	IXFH 30N85X	61	IXFH 340N075T2	46
IXBT 32N300HV	4, 33	IXFB 30N120P	53	➤ IXFH 32N100X	62	IXFH 400N075T2	46
IXBT 42N170	32	IXFB 40N110P	53	IXFH 34N50P3	55	IXFJ 20N85X	7, 61
IXBT 42N170A	32	IXFB 40N110Q3	63	IXFH 34N65X2	60	IXFJ 26N50P3	7, 54
IXBT 42N300HV	4, 33	IXFB 44N100P	53	IXFH 36N50P	51	IXFJ 80N25X3	7, 57
IXBX 28N300HV	5, 33	IXFB 44N100Q3	63	IXFH 36N60P	51	IXFK 20N120P	53
IXBX 50N360HV	5, 33	IXFB 52N90P	52	IXFH 40N85X	61	IXFK 24N80P	52
IXBX 55N300	33	IXFB 60N80P	52	IXFH 42N50P2	54	IXFK 24N100Q3	63
IXBX 64N250	32	IXFB 62N80Q3	63	IXFH 42N60P3	55	IXFK 26N100P	53
IXBX 75N170	32	➤ IXFB 70N100X	62	IXFH 44N50P	51	IXFK 26N120P	53
IXBX 75N170A	32	IXFB 82N60P	51	IXFH 44N50Q3	63	IXFK 32N80P	52
IXCH 36N250	32	IXFB 82N60Q3	63	IXFH 46N30T	44	IXFK 32N80Q3	63
IXCK 36N250	32	IXFB 90N85X	61	IXFH 46N65X2	60	IXFK 32N90P	52
○ IXDH 20N120	28	IXFB 100N50P	51	IXFH 50N30Q3	63	IXFK 32N100P	53
○ IXDH 20N120D1	28	IXFB 100N50Q3	63	IXFH 50N60P3	55	IXFK 32N100Q3	63
○ IXDH 30N120D1	28	IXFB 110N60P3	55	IXFH 50N85X	61	➤ IXFK 32N100X	62
○ IXDN 55N120D1	28	IXFB 120N50P2	54	IXFH 52N30P	50	IXFK 36N60P	51
○ IXDN 75N120	28	IXFB 132N50P3	55	IXFH 52N50P2	54	IXFK 40N90P	52

Alphanumeric Index

> New
 ○ Not for new design
 ◇ Under development

IXFK 44N50P	51	IXFL 210N30P3	54	IXFN 240N25X3	57	IXFP 130N10T	44
IXFK 44N80P	52	IXFN 20N120P	53	IXFN 300N10P	50	IXFP 130N10T2	46
IXFK 44N80Q3	63	IXFN 26N100P	53	IXFN 300N20X3	56	IXFP 180N10T2	46
IXFK 48N60P	51	IXFN 26N120P	53	IXFN 320N17T2	46	IXFP 220N06T3	47
IXFK 48N60Q3	63	> IXFN 27N120SK	73	IXFN 360N10T	44	IXFP 230N075T2	46
IXFK 50N85X	61	IXFN 30N120P	53	IXFN 360N15T2	46	IXFP 270N06T3	47
> IXFK 52N100X	62	IXFN 32N80P	52	IXFN 420N10T	44	IXFQ 8N85X	61
IXFK 64N50P	51	IXFN 32N100P	53	IXFN 520N075T2	46	IXFQ 10N80P	52
IXFK 64N50Q3	63	IXFN 32N100Q3	63	IXFP 4N85X	61	IXFQ 14N80P	52
IXFK 64N60P	51	IXFN 32N120P	53	IXFP 4N85XM	61	IXFQ 20N50P3	55
IXFK 64N60P3	55	IXFN 38N100P	53	IXFP 4N100P	53	IXFQ 22N60P3	55
IXFK 64N60Q3	63	IXFN 40N90P	52	IXFP 5N100P	53	IXFQ 24N50P2	54
IXFK 66N85X	61	IXFN 40N110P	53	IXFP 6N120P	53	IXFQ 26N50P3	55
IXFK 78N50P3	55	IXFN 40N110Q3	63	IXFP 7N80P	52	IXFQ 28N60P3	55
IXFK 80N50P	51	IXFN 44N80P	52	IXFP 7N100P	53	IXFQ 34N50P3	55
IXFK 80N50Q3	63	IXFN 44N80Q3	63	IXFP 8N65X2	60	IXFQ 50N60P3	55
IXFK 80N60P3	55	IXFN 44N100P	53	IXFP 8N85X	61	IXFQ 60N25X3	57
IXFK 80N65X2	60	IXFN 44N100Q3	63	IXFP 8N85XM	61	IXFQ 60N50P3	55
IXFK 88N30P	50	IXFN 48N60P	51	IXFP 10N60P	51	IXFQ 72N20X3	56
IXFK 94N50P2	54	IXFN 50N120SiC	73	IXFP 10N80P	52	IXFQ 72N30X3	58
IXFK 98N50P3	55	IXFN 50N120SK	73	IXFP 12N50P	51	IXFQ 80N25X3	57
IXFK 100N65X2	60	IXFN 52N90P	52	IXFP 12N65X2	60	IXFQ 90N20X3	56
IXFK 102N30P	50	> IXFN 52N100X	62	IXFP 12N65X2M	60	IXFQ 94N30P3	54
IXFK 120N20P	50	IXFN 56N90P	52	IXFP 14N60P	51	IXFQ 120N25X3	57
IXFK 120N25P	50	IXFN 60N80P	52	IXFP 14N60P3	55	IXFQ 140N20X3	56
IXFK 120N30P3	54	IXFN 62N80Q3	63	IXFP 14N85X	61	IXFR 15N100Q3	63
IXFK 120N30T	44	IXFN 64N50P	51	> IXFP 14N85XM	61	IXFR 16N120P	53
IXFK 120N65X2	60	IXFN 64N60P	51	IXFP 16N50P	51	IXFR 18N90P	52
IXFK 140N20P	50	IXFN 66N85X	61	IXFP 16N50P3	54	IXFR 20N80P	52
IXFK 140N25T	44	> IXFN 70N100X	62	IXFP 16N60P3	55	IXFR 20N100P	53
IXFK 140N30P	50	IXFN 70N120SK	73	IXFP 18N65X2	60	IXFR 20N120P	53
IXFK 150N15P	50	> IXFN 74N100X	62	IXFP 18N65X2M	60	IXFR 24N80P	52
IXFK 150N30P3	54	IXFN 80N50P	51	IXFP 20N50P3	54	IXFR 24N90P	52
IXFK 150N30X3	58	IXFN 80N50Q3	63	IXFP 20N85X	61	IXFR 24N100Q3	63
IXFK 160N30T	44	IXFN 80N60P3	55	IXFP 22N60P3	55	IXFR 26N100P	53
IXFK 170N10P	50	IXFN 82N60P	51	IXFP 22N65X2	60	IXFR 26N120P	53
IXFK 170N20P	50	IXFN 82N60Q3	63	IXFP 22N65X2M	60	IXFR 30N60P	51
IXFK 170N20T	44	IXFN 90N85X	61	IXFP 26N30X3	58	IXFR 32N80P	52
IXFK 170N25X3	57	> IXFN 90N170SK	73	IXFP 26N50P3	55	IXFR 32N80Q3	63
IXFK 180N15P	50	IXFN 94N50P2	54	IXFP 30N25X3	57	IXFR 32N100P	53
IXFK 180N25T	44	IXFN 100N50P	51	IXFP 30N25X3M	57	IXFR 32N100Q3	63
IXFK 200N10P	50	IXFN 100N50Q3	63	IXFP 34N65X2	60	IXFR 36N50P	51
IXFK 210N30X3	58	IXFN 100N65X2	60	IXFP 34N65X2M	60	IXFR 36N60P	51
IXFK 220N15P	50	IXFN 102N30P	50	IXFP 36N20X3	56	IXFR 40N90P	52
IXFK 220N17T2	46	IXFN 110N60P3	55	IXFP 36N20X3M	56	IXFR 44N50P	51
IXFK 220N20X3	56	IXFN 110N85X	61	IXFP 36N30P3	54	IXFR 44N50Q3	63
IXFK 230N20T	44	IXFN 120N65X2	60	IXFP 38N30X3	58	IXFR 44N80P	52
IXFK 240N15T2	46	> IXFN 130N90SK	73	IXFP 38N30X3M	58	IXFR 48N60P	51
IXFK 240N25X3	57	IXFN 132N50P3	55	IXFP 44N25X3	57	IXFR 48N60Q3	63
IXFK 250N10P	50	IXFN 140N20P	50	IXFP 44N25X3M	57	IXFR 64N50P	51
IXFK 300N20X3	56	IXFN 140N25T	44	IXFP 50N20X3	56	IXFR 64N50Q3	63
IXFK 320N17T2	46	IXFN 140N30P	50	IXFP 50N20X3M	56	IXFR 64N60P	51
IXFK 360N10T	44	IXFN 150N65X2	60	IXFP 56N30X3	58	IXFR 64N60Q3	63
IXFK 360N15T2	46	IXFN 160N30T	44	IXFP 56N30X3M	58	IXFR 80N50P	51
IXFK 420N10T	44	IXFN 170N25X3	57	IXFP 60N25X3	57	IXFR 80N50Q3	63
IXFK 520N075T2	46	IXFN 170N30P	50	IXFP 60N25X3M	57	IXFR 80N60P3	55
IXFL 30N120P	53	IXFN 170N65X2	60, 60	IXFP 72N20X3	56	IXFR 102N30P	50
IXFL 32N120P	53	IXFN 180N15P	50	IXFP 72N20X3M	56	IXFR 140N20P	50
IXFL 36N110P	53	IXFN 180N25T	44	IXFP 72N30X3	58	IXFR 140N30P	50
IXFL 38N100P	53	IXFN 200N10P	50	IXFP 72N30X3M	58	IXFR 180N15P	50
IXFL 40N110P	53	IXFN 210N20P	50	IXFP 76N15T2	46	IXFR 200N10P	50
IXFL 44N100P	53	IXFN 210N30P3	54	IXFP 80N25X3	57	IXFR 230N20T	44
IXFL 60N80P	52	IXFN 210N30X3	58	IXFP 90N20X3	56	IXFT 14N80P	52
IXFL 82N60P	51	IXFN 220N20X3	56	IXFP 90N20X3M	56	IXFT 15N100Q3	63
IXFL 100N50P	51	IXFN 230N20T	44	IXFP 102N15T	44	IXFT 16N80P	52
IXFL 132N50P3	55	IXFN 240N15T2	46	IXFP 110N15T2	46	IXFT 16N120P	53

Alphanumeric Index

- New
- Not for new design
- ◇ Under development

IXFT 18N90P	52	➤ IXFX 52N100X	62	IXGH 24N170	30	IXKR 40N60C	70
IXFT 18N100Q3	63	IXFX 64N50P	51	IXGH 24N170A	30	○ IXKR 47N60C5	70
IXFT 20N80P	52	IXFX 64N50Q3	63	IXGH 25N250	31	IXKT 70N60C5	70
IXFT 20N100P	53	IXFX 64N60P	51	IXGH 32N100A3	29	IXLF 19N250A	16, 31
IXFT 24N80P	52	IXFX 64N60P3	55	IXGH 32N120A3	29	IXTA 1N100P	49
IXFT 24N90P	52	IXFX 64N60Q3	63	IXGH 32N170	30	IXTA 1N120P	49
IXFT 26N60P	51	IXFX 66N85X	61	IXGH 32N170A	30	IXTA 1N200P3HV	3, 64
➤ IXFT 26N100XHV	4, 62	IXFX 78N50P3	55	IXGH 36N60A3	29	IXTA 1R4N100P	49
IXFT 30N50P	51	IXFX 80N50P	51	IXGH 36N60A3D4	29	IXTA 1R4N120P	49
IXFT 30N50Q3	63	IXFX 80N50Q3	63	IXGH 48N60A3	29	IXTA 1R6N100D2	67
IXFT 30N60P	51	IXFX 80N60P3	55	IXGH 48N60A3D1	29	IXTA 1R6N50D2	67
IXFT 30N85XHV	4, 61	IXFX 94N50P2	54	IXGH 56N60A3	29	IXTA 2N100P	49
➤ IXFT 32N100XHV	4, 62	IXFX 98N50P3	55	IXGH 64N60A3	29	IXTA 02N250HV	3, 64
IXFT 36N50P	51	IXFX 100N65X2	60	IXGH 72N60A3	29	IXTA 2R4N120P	49
IXFT 36N60P	51	IXFX 120N25P	50	IXGK 55N120A3H1	29	IXTA 3N50D2	67
IXFT 40N85XHV	4, 61	IXFX 120N30P3	54	IXGK 72N60A3H1	29	IXTA 3N100D2	67
IXFT 42N50P2	54	IXFX 120N30T	44	IXGK 75N250	31	IXTA 3N100D2HV	3, 67
IXFT 44N50P	51	IXFX 120N65X2	60	IXGK 82N120A3	29	IXTA 3N100P	49
IXFT 44N50Q3	63	IXFX 140N25T	44	IXGK 100N170	30	IXTA 3N120	65
IXFT 46N30T	44	IXFX 140N30P	50	IXGK 120N120A3	29	IXTA 3N120HV	3, 65
IXFT 50N30Q3	63	IXFX 150N30P3	54	IXGK 320N60A3	29	IXTA 3N150HV	3, 65
IXFT 50N60P3	55	IXFX 160N30T	44	IXGL 75N250	31	IXTA 4N65X2	59
IXFT 50N85XHV	4, 61	IXFX 170N20P	50	IXGN 72N60A3	29	IXTA 4N70X2	61
IXFT 52N50P2	54	IXFX 170N20T	44	IXGN 100N170	30	IXTA 4N150HV	3, 65
IXFT 60N50P3	55	IXFX 180N15P	50	IXGN 120N60A3	29	IXTA 05N100HV	3, 65
IXFT 60N65X2HV	4, 60	IXFX 180N25T	44	IXGN 120N60A3D1	29	IXTA 05N100P	49
IXFT 69N30P	50	IXFX 200N10P	50	IXGN 200N170	30	IXTA 6N50D2	67
IXFT 70N20Q3	63	IXFX 210N30X3	58	IXGN 320N60A3	29	IXTA 6N100D2	67
IXFT 70N30Q3	63	IXFX 220N15P	50	IXGN 400N60A3	29	IXTA 06N120P	49
IXFT 80N65X2HV	4, 60	IXFX 220N17T2	46	IXGP 12N120A3	29	IXTA 08N50D2	67
IXFT 86N30T	44	IXFX 230N20T	44	IXGP 20N120A3	29	IXTA 8N65X2	59
IXFT 88N30P	50	IXFX 240N15T2	46	IXGP 36N60A3	29	IXTA 8N70X2	61
IXFT 94N30P3	54	IXFX 240N25X3	57	IXGP 48N60A3	29	IXTA 08N100D2	67
IXFT 94N30T	44	IXFX 250N10P	50	IXGR 6N170A	30	IXTA 08N100D2HV	3, 67
IXFT 96N20P	50	IXFX 300N20X3	56	IXGR 55N120A3H1	29	IXTA 08N100P	49
IXFT 100N30X3HV	4, 58	IXFX 320N17T2	46	IXGR 72N60A3H1	29	IXTA 08N120P	49
IXFT 120N15P	50	IXFX 360N10T	44	IXGT 6N170	30	IXTA 10N60P	49
IXFT 120N25T	44	IXFX 360N15T2	46	IXGT 6N170A	30	IXTA 10P15T	69
IXFT 120N25X3HV	4, 57	IXFX 420N10T	44	IXGT 10N170	30	IXTA 10P50P	68
IXFT 120N30X3HV	4, 58	IXFX 520N075T2	46	IXGT 10N170A	30	IXTA 12N50P	49
IXFT 140N10P	50	IXFY 4N85X	61	IXGT 16N170	30	IXTA 12N65X2	59
IXFT 140N20X3HV	4, 56	IXFY 8N65X2	60	IXGT 16N170A	30	IXTA 12N70X2	61
IXFT 150N17T2	46	IXFY 26N30X3	58	IXGT 24N170	30	IXTA 14N60P	49
IXFT 150N20T	44	IXFY 30N25X3	57	IXGT 24N170A	30	IXTA 15N50L2	66
IXFT 150N25X3HV	4, 57	IXFY 36N20X3	56	IXGT 25N250	31	IXTA 15P15T	69
IXFT 150N30X3HV	4, 58	IXFZ 140N25T	44	IXGT 25N250HV	4, 31	IXTA 16N50P	49
IXFT 170N25X3HV	4, 57	IXFZ 520N075T2	46	IXGT 32N100A3	29	IXTA 18P10T	69
IXFT 180N20X3HV	4, 56	IXG 50I4500KN	31	IXGT 32N120A3	29	IXTA 20N65X2	59
IXFT 220N20X3HV	4, 56	➤ IXG 65I3300KN	31	IXGT 32N170	30	IXTA 24N65X2	59
IXFT 320N10T2	46	➤ IXG 70IF1200NA	28	IXGT 32N170A	30	IXTA 24P085T	69
IXFT 340N075T2	46	IXGA 12N120A3	29	IXGT 72N60A3	29	IXTA 26P10T	69
IXFT 400N075T2	46	IXGA 20N120A3	29	IXGX 55N120A3H1	29	IXTA 26P20P	68
IXFX 20N120P	53	IXGA 20N250HV	3, 31	IXGX 72N60A3H1	29	IXTA 28P065T	69
IXFX 24N100Q3	63	IXGA 36N60A3	29	IXGX 75N250	31	➤ IXTA 30N25L2	66
IXFX 26N100P	53	IXGA 48N60A3	29	IXGX 82N120A3	29	IXTA 30N65X2	59
IXFX 26N120P	53	IXGF 20N250	16, 31	IXGX 100N170	30	IXTA 32P05T	69
IXFX 32N80P	52	IXGF 25N250	16, 31	IXGX 120N60A3	29	IXTA 32P20T	69
IXFX 32N80Q3	63	IXGF 32N170	16, 30	IXGX 120N120A3	29	IXTA 34N65X2	59, 59
IXFX 32N90P	52	IXGH 6N170	30	IXGX 320N60A3	29	IXTA 36N30P	48
IXFX 32N100P	53	IXGH 6N170A	30	○ IXKC 20N60C	70	IXTA 36P15P	68
IXFX 32N100Q3	63	IXGH 10N170	30	IXKF 40N60SCD1	16, 70	IXTA 42N25P	48
IXFX 40N90P	52	IXGH 10N170A	30	○ IXKH 35N60C5	70	IXTA 44P15T	69
IXFX 44N80P	52	IXGH 12N120A3	29	○ IXKH 70N60C5	70	IXTA 48N20T	43
IXFX 44N80Q3	63	IXGH 16N170	30	○ IXKN 40N60C	70	IXTA 48P05T	69
IXFX 48N60P	51	IXGH 16N170A	30	○ IXKN 75N60C	70	IXTA 50N20P	48
IXFX 48N60Q3	63	IXGH 20N120A3	29	IXKR 25N80C	70	IXTA 50N25T	43

Alphanumeric Index

> New
 ○ Not for new design
 ◇ Under development

IXTA 52P10P	68	IXTH 3N200P3HV	6, 64	IXTH 140P05T	69	IXTN 240N075L2	66
IXTA 60N10T	43	IXTH 4N150	65	IXTH 140P10T	69	> IXTN 400N15X4	56
IXTA 60N20T	43	IXTH 04N300P3HV	6, 64	> IXTH 150N15X4	56	IXTN 550N055T2	45
IXTA 62N15P	48	IXTH 05N250P3HV	6, 64	IXTH 180N10T	43	IXTN 600N04T2	45
IXTA 64N10L2	66	IXTH 6N50D2	67	IXTH 200N10T	43	IXTN 660N04T4	47
IXTA 70N075T2	45	IXTH 6N100D2	67	> IXTH 240N15X4	56	IXTP 1N100P	49
IXTA 75N10P	48	IXTH 6N120	65	IXTH 260N055T2	45	IXTP 1N120P	49
IXTA 76N25T	43	IXTH 6N150	65	IXTH 270N04T4	47	IXTP 1R4N100P	49
IXTA 76P10T	69	IXTH 06N220P3HV	6, 64	IXTH 300N04T2	45	IXTP 1R4N120P	49
IXTA 80N075L2	66	IXTH 10N100D2	67	IXTH 340N04T4	47	IXTP 1R6N100D2	67
IXTA 80N12T2	45	IXTH 10P50P	68	IXTH 360N055T2	45	IXTP 1R6N50D2	67
IXTA 86N20T	43	IXTH 12N65X2	59	IXTH 420N04T2	45	IXTP 2N65X2	59
IXTA 90N055T2	45	IXTH 12N70X2	61	IXTH 440N055T2	45	IXTP 2N100P	49
IXTA 90N075T2	45	IXTH 15N50L2	66	IXTH 450P2	54	IXTP 02N120P	49
IXTA 96P085T	69	IXTH 16N10D2	67	IXTH 460P2	54	IXTP 2R4N120P	49
IXTA 100N04T2	45	IXTH 16N20D2	67	IXTH 500N04T2	45	IXTP 3N50D2	67
> IXTA 100N15X4	56	IXTH 16N50D2	67	IXTJ 3N150	7, 65	IXTP 3N100D2	67
IXTA 110N055T2	45	IXTH 16P60P	68	IXTJ 4N150	7, 65	IXTP 3N100P	49
IXTA 120N04T2	45	IXTH 20N65X2	59	IXTJ 6N150	7, 65	IXTP 3N120	65
IXTA 120N075T2	45	IXTH 20P50P	68	IXTK 5N250	64	IXTP 4N65X2	59
IXTA 120P065T	69	IXTH 22N50P	49	IXTK 32P60P	68	IXTP 4N70X2	61
IXTA 130N065T2	45	IXTH 24N65X2	59	IXTK 40P50P	68	IXTP 4N70X2M	61
IXTA 130N10T	43	IXTH 26N60P	49	IXTK 60N50L2	66	IXTP 05N100P	49
> IXTA 130N15X4	56	IXTH 26P20P	68	IXTK 80N30L2	66	IXTP 6N50D2	67
> IXTA 130N15X4-7	56	> IXTH 30N25L2	66	IXTK 82N25P	48	IXTP 6N100D2	67
IXTA 140N055T2	45	IXTH 30N50L2	66	IXTK 88N30P	48	IXTP 06N120P	49
IXTA 140P05T	69	IXTH 30N50P	49	IXTK 90N25L2	66	IXTP 08N50D2	67
> IXTA 150N15X4	56	IXTH 30N60L2	66	IXTK 90P20P	68	IXTP 8N65X2	59
> IXTA 150N15X4-7	56	IXTH 30N60P	49	IXTK 100N25P	48	IXTP 8N65X2M	59
IXTA 160N04T2	45	IXTH 30N65X2	59	IXTK 102N30P	48	IXTP 8N70X2	61
IXTA 170N075T2	45	IXTH 32P20T	69	IXTK 102N65X2	59	IXTP 8N70X2M	61
IXTA 180N10T	43	IXTH 34N65X2	59	IXTK 110N20L2	66	IXTP 08N100D2	67
IXTA 200N055T2	45	IXTH 36N50P	49	IXTK 120N20P	48	IXTP 08N100P	49
IXTA 220N04T2	45	IXTH 36P15P	68	IXTK 120N25P	48	IXTP 08N120P	49
IXTA 230N04T4	47	IXTH 38N30L2	66	IXTK 120N65X2	59	IXTP 10N60P	49
IXTA 230N075T2	45	IXTH 40N50L2	66	IXTK 120P20T	69	IXTP 10P15T	69
IXTA 260N055T2	45	> IXTH 44N25L2	66	IXTK 140N20P	48	IXTP 10P50P	68
IXTA 270N04T4	47	IXTH 44P15T	69	IXTK 140N30P	48	IXTP 12N50P	49
IXTA 270N04T4-7	47	IXTH 48N65X2	59	IXTK 150N15P	48	IXTP 12N65X2	59
IXTA 300N04T2	45	IXTH 48P20P	68	IXTK 170N10P	48	IXTP 12N65X2M	59
IXTA 340N04T4	47	IXTH 50N25T	43	IXTK 170P10P	68	IXTP 12N70X2	61
IXTA 340N04T4-7	47	IXTH 50N30L2	66	IXTK 180N15P	48	IXTP 12N70X2M	61
IXTA 380N036T4-7	47	IXTH 52P10P	68	IXTK 200N10L2	66	IXTP 14N60P	49
IXTA 460P2	54	IXTH 58N25L2	66	IXTK 200N10P	48	IXTP 15N50L2	66
IXTF 1N250	16, 64	IXTH 60N20L2	66	IXTK 210P10T	69	IXTP 15P15T	69
IXTF 1N450	16, 64	IXTH 62N65X2	59	IXTK 240N075L2	66	IXTP 16N50P	49
IXTF 1R4N450	16, 64	IXTH 64N10L2	66	> IXTK 400N15X4	56	IXTP 18P10T	69
IXTF 2N300P3	16, 64	IXTH 68P20T	69	IXTK 550N055T2	45	IXTP 20N65X2	59
IXTF 02N450	16, 64	IXTH 75N10L2	66	IXTK 600N04T2	45	IXTP 20N65X2M	59
IXTF 6N200P3	16, 64	IXTH 76N25T	43	IXTL 2N450	64	IXTP 24N65X2	59
IXTF 200N10T	16, 43	IXTH 76P10T	69	IXTL 2N470	64	IXTP 24N65X2M	59
IXTH 1N200P3	64	IXTH 80N075L2	66	IXTL 2x180N10T	43	IXTP 24P085T	69
IXTH 1N200P3HV	6, 64	IXTH 80N65X2	59	IXTN 5N250	64	IXTP 26P10T	69
IXTH 1N250	64	IXTH 86N25T	43	IXTN 32P60P	68	IXTP 26P20P	68
IXTH 1N300P3HV	6, 64	IXTH 88N30P	48	IXTN 40P50P	68	IXTP 28P065T	69
IXTH 1N450HV	5, 64	IXTH 90P10P	68	IXTN 60N50L2	66	> IXTP 30N25L2	66
IXTH 1R4N250P3	64	IXTH 96N20P	48	IXTN 80N30L2	66	IXTP 30N65X2	59
IXTH 1R8N220P3HV	6, 64	IXTH 96N25T	43	IXTN 90N25L2	66	IXTP 32P05T	69
IXTH 2N170D2	67	IXTH 96P085T	69	IXTN 90P20P	68	IXTP 32P20T	69
IXTH 02N250	64	IXTH 110N10L2	66	IXTN 102N65X2	59	IXTP 34N65X2	59
IXTH 2N300P3HV	6, 64	IXTH 110N25T	43	IXTN 110N20L2	66	IXTP 36N30P	48
IXTH 02N450HV	5, 64	IXTH 120P065T	69	IXTN 120P20T	69	IXTP 36P15P	68
IXTH 2R4N120P	49	IXTH 130N10T	43	IXTN 170P10P	68	IXTP 42N25P	48
IXTH 3N100P	49	> IXTH 130N15X4	56	IXTN 200N10L2	66	IXTP 44N10T	43
IXTH 3N120	65	IXTH 130N20T	43	IXTN 200N10T	43	IXTP 44P15T	69
IXTH 3N150	65	IXTH 140N075L2	66	IXTN 210P10T	69	IXTP 48N20T	43

Alphanumeric Index

- New
- Not for new design
- ✦ Under development

IXTP 48P05T	69	IXTQ 44P15T	69	IXTT 16P60P	68	IXTY 1R6N100D2	67
IXTP 50N20P	48	IXTQ 48N20T	43	IXTT 20P50P	68	IXTY 1R6N50D2	67
IXTP 50N25T	43	IXTQ 50N20P	48	IXTT 26N50P	49	IXTY 2N65X2	59
IXTP 52P10P	68	IXTQ 50N25T	43	IXTT 26N60P	49	IXTY 2N100P	49
IXTP 60N10T	43	IXTQ 52N30P	48	IXTT 30N50L2	66	IXTY 02N120P	49
IXTP 60N20T	43	IXTQ 52P10P	68	IXTT 30N50P	49	IXTY 4N65X2	59
IXTP 62N15P	48	IXTQ 60N10T	43	IXTT 30N60L2	66	IXTY 4N70X2	61
IXTP 64N10L2	66	IXTQ 60N20L2	66	IXTT 30N60P	49	IXTY 08N50D2	67
IXTP 70N075T2	45	IXTQ 60N20T	43	IXTT 34N65X2HV	4, 59	IXTY 8N65X2	59
IXTP 75N10P	48	IXTQ 62N15P	48	IXTT 36N50P	49	IXTY 8N70X2	61
IXTP 76N25T	43	IXTQ 64N25P	48	IXTT 38N30L2	66	IXTY 08N100D2	67
IXTP 76P10T	69	IXTQ 69N30P	48	IXTT 40N50L2	66	IXTY 08N100P	49
IXTP 80N075L2	66	IXTQ 74N20P	48	➤ IXTT 44N25L2HV	4, 66	IXTY 10P15T	69
IXTP 80N10T	43	IXTQ 75N10P	48	IXTT 48P20P	68	IXTY 15P15T	69
IXTP 80N12T2	45	IXTQ 76N25T	43	IXTT 52N30P	48	IXTY 18P10T	69
IXTP 86N20T	43	IXTQ 82N25P	48	IXTT 60N20L2	66	IXTY 26P10T	69
IXTP 90N055T2	45	IXTQ 86N20T	43	IXTT 64N25P	48	IXTY 32P05T	69
IXTP 90N075T2	45	IXTQ 86N25T	43	IXTT 68P20T	69	IXTY 44N10T	43
IXTP 96P085T	69	IXTQ 88N30P	48	IXTT 69N30P	48	IXTY 48P05T	69
IXTP 100N04T2	45	IXTQ 96N15P	48	IXTT 74N20P	48	IXTY 90N055T2	45
➤ IXTP 100N15X4	56	IXTQ 96N20P	48	IXTT 75N10L2	66	IXTZ 550N055T2	45
IXTP 110N055T2	45	IXTQ 96N25T	43	IXTT 82N25P	48	IXXA 50N60B3	22
IXTP 120N04T2	45	IXTQ 100N25P	48	IXTT 88N30P	48	IXXH 30N60B3	22
IXTP 120N075T2	45	IXTQ 110N10P	48	IXTT 90P10P	68	IXXH 30N60B3D1	22
IXTP 120P065T	69	IXTQ 120N15P	48	IXTT 96N15P	48	IXXH 30N60C3	22
IXTP 130N065T2	45	IXTQ 120N20P	48	IXTT 96N20P	48	IXXH 30N60C3D1	22
IXTP 130N10T	43	IXTQ 130N10T	43	IXTT 100N25P	48	IXXH 30N65B4	24
➤ IXTP 130N15X4	56	IXTQ 140N10P	48	IXTT 110N10L2	66	IXXH 30N65B4D1	24
IXTP 140N055T2	45	IXTQ 150N15P	48	IXTT 110N10P	48	IXXH 30N65C4D1	24
IXTP 140P05T	69	IXTQ 170N10P	48	IXTT 120N15P	48	IXXH 40N65B4	24
➤ IXTP 150N15X4	56	IXTQ 180N10T	43	IXTT 140N075L2HV	4, 66	IXXH 40N65B4D1	24
IXTP 160N04T2	45	IXTQ 200N10T	43	IXTT 140N10P	48	IXXH 40N65B4H1	24
IXTP 170N075T2	45	IXTQ 450P2	54	IXTT 140P10T	69	IXXH 40N65C4D1	24
➤ IXTP 170N13X4	56	IXTQ 460P2	54	IXTT 170N10P	48	IXXH 50N60B3	22
IXTP 180N10T	43	IXTQ 470P2	54	➤ IXTT 240N15X4HV	4, 56	IXXH 50N60B3D1	22
IXTP 200N055T2	45	IXTQ 480P2	54	IXTT 360N055T2	45	IXXH 50N60C3	22
IXTP 220N04T2	45	IXTR 16P60P	68	IXTT 440N04T4HV	4, 47	IXXH 50N60C3D1	22
IXTP 230N04T4	47	IXTR 20P50P	68	IXTT 440N055T2	45	IXXH 60N65B4	24
➤ IXTP 230N04T4M	47	IXTR 32P60P	68	IXTT 500N04T2	45	IXXH 60N65B4H1	24
IXTP 230N075T2	45	IXTR 36P15P	68	IXTU 4N70X2	61	IXXH 60N65C4	24
IXTP 260N055T2	45	IXTR 40P50P	68	IXTU 8N70X2	61	IXXH 75N60B3	22
IXTP 270N04T4	47	IXTR 48P20P	68	IXTX 1R4N450HV	5, 64	IXXH 75N60B3D1	22
IXTP 300N04T2	45	IXTR 68P20T	69	IXTX 4N300P3HV	6, 64	IXXH 75N60C3	22
IXTP 340N04T4	47	IXTR 90P10P	68	IXTX 5N250	64	IXXH 75N60C3D1	22
IXTP 450P2	54	IXTR 90P20P	68	IXTX 6N200P3HV	6, 64	IXXH 80N65B4	24
IXTP 460P2	54	IXTR 102N65X2	59	IXTX 32P60P	68	IXXH 80N65B4D1	24
IXTQ 10P50P	68	IXTR 120P20T	69	IXTX 40P50P	68	IXXH 80N65B4H1	24
IXTQ 14N60P	49	IXTR 140P10T	69	IXTX 60N50L2	66	IXXH 100N60B3	22
IXTQ 16N50P	49	IXTR 170P10P	68	IXTX 80N30L2	66	IXXH 100N60C3	22
IXTQ 18N60P	49	IXTR 200N10P	48	IXTX 90N25L2	66	IXXH 110N65B4	24
IXTQ 22N50P	49	IXTR 210P10T	69	IXTX 90P20P	68	IXXH 110N65C4	24
IXTQ 22N60P	49	IXTT 1N250HV	4, 64	IXTX 102N65X2	59	IXXH 140N65B4	24
IXTQ 26N50P	49	IXTT 1N300P3HV	4, 64	IXTX 110N20L2	66	IXXH 140N65C4	24
IXTQ 26N60P	49	IXTT 1N450HV	4, 64	IXTX 120N65X2	59	IXXK 100N60B3H1	22
IXTQ 26P20P	68	IXTT 2N170D2	67	IXTX 120P20T	69	IXXK 100N60C3H1	22
IXTQ 30N50L2	66	IXTT 2N300P3HV	4, 64	IXTX 170P10P	68	IXXK 110N65B4H1	24
IXTQ 30N50P	49	IXTT 02N450HV	4, 64	IXTX 200N10L2	66	IXXK 160N65B4	24
IXTQ 30N60L2	66	IXTT 3N200P3HV	4, 64	IXTX 210P10T	69	IXXK 160N65C4	24
IXTQ 30N60P	49	IXTT 4N150HV	4, 65	IXTX 240N075L2	66	IXXK 200N60B3	22
IXTQ 32P20T	69	IXTT 6N120	65	➤ IXTX 400N15X4	56	IXXK 200N60C3	22
IXTQ 36N30P	48	IXTT 6N150	65	IXTX 550N055T2	45	IXXK 200N65B4	24
IXTQ 36N50P	49	IXTT 10N100D2	67	IXTX 600N04T2	45	IXXK 300N60B3	22
IXTQ 36P15P	68	IXTT 12N150HV	4, 65	IXTY 1N100P	49	IXXK 300N60C3	22
IXTQ 40N50L2	66	IXTT 16N10D2	67	IXTY 1R4N100P	49	IXXN 100N60B3H1	22
IXTQ 42N25P	48	IXTT 16N20D2	67	➤ IXTY 1R4N120P	49	IXXN 110N65B4H1	24
IXTQ 44N50P	49	IXTT 16N50D2	67	➤ IXTY 1R4N120PHV	2, 49	IXXN 110N65C4H1	24

Alphanumeric Index

> New
 ○ Not for new design
 ◇ Under development

IXXN 200N60B3	22	IXYH 30N170C	27	IXYP 8N90C3D1	26	◇LSIC1MO120T0120	71
IXXN 200N60B3H1	22	IXYH 30N450HV	5, 31	IXYP 10N65B3D1	23	◇LSIC1MO120T0160	71
IXXN 200N60C3H1	22	IXYH 40N65B3	23	IXYP 10N65C3	23	LSIC1MO170E1000	71
IXXN 200N65A4	24	IXYH 40N65B3D1	23	IXYP 10N65C3D1	23	◇LSIC1MO170H0750	71
IXXN 340N65B4	24	IXYH 40N65C3	23	IXYP 15N65C3	23	>LSIC1MO170T0750	71
IXXP 12N65B4	24	IXYH 40N65C3D1	23	IXYP 15N65C3D1	23	◇LSIC2SB065B10A	72
IXXP 12N65B4D1	24	IXYH 40N65C3H1	23	IXYP 20N65B3	23	◇LSIC2SB065B20A	72
IXXP 50N60B3	22	IXYH 40N90C3	26	IXYP 20N65B3D1	23	◇LSIC2SB065B32A	72
IXXQ 30N60B3M	22	IXYH 40N90C3D1	26	IXYP 20N65C3D1	23	◇LSIC2SB065B40A	72
IXXR 100N60B3H1	22	>IXYH 40N120A4	25	IXYP 20N120A4	25	◇LSIC2SB120B10A	72
IXXR 110N65B4H1	24	IXYH 40N120B3	26	>IXYP 20N120B4	25	◇LSIC2SB120B20A	72
IXXX 100N60B3H1	22	IXYH 40N120B3D1	26	IXYP 20N120C3	26	◇LSIC2SB120B30A	72
IXXX 100N60C3H1	22	>IXYH 40N120B4	25	>IXYP 20N120C4	26	◇LSIC2SB120B40A	72
IXXX 110N65B4H1	24	IXYH 40N120C3	26	IXYP 30N65C3	23	◇LSIC2SB170B10A	72
IXXX 140N65B4H1	24	IXYH 40N120C3D1	26	IXYP 30N120A4	25	◇LSIC2SB170B25A	72
IXXX 160N65B4	24	>IXYH 40N120C4	25	IXYP 30N120C3	26	◇LSIC2SB170B50A	72
IXXX 160N65C4	24	IXYH 50N65C3	23	IXYP 50N65C3	23	>LSIC2SD065A06A	72
IXXX 200N60B3	22	IXYH 50N65C3D1	23	IXYQ 30N65B3D1	23	>LSIC2SD065A08A	72
IXXX 200N60C3	22	IXYH 50N65C3H1	23	IXYQ 40N65B3D1	23	>LSIC2SD065A10A	72
IXXX 200N65B4	24	IXYH 50N120C3	26	IXYQ 40N65C3D1	23	>LSIC2SD065A16A	72
IXXX 300N60B3	22	IXYH 50N120C3D1	26	IXYR 50N120C3D1	26	>LSIC2SD065A20A	72
IXXX 300N60C3	22	>IXYH 55N120A4	25	IXYR 100N120C3	26	◇LSIC2SD065B16A	72
IXYA 8N90C3D1	26	IXYH 60N90C3	26	IXYT 12N250CV1HV	4, 27	>LSIC2SD065C06A	72
IXYA 8N250CHV	3, 27	IXYH 75N65C3	23	IXYT 20N120C3D1HV	4, 26	>LSIC2SD065C08A	72
IXYA 12N250CHV	3, 27	IXYH 75N65C3D1	23	IXYT 25N250CHV	4, 27	>LSIC2SD065C10A	72
IXYA 15N65C3D1	23	IXYH 75N65C3H1	23	IXYT 30N65C3H1HV	4, 23	>LSIC2SD065C16A	72
IXYA 20N65B3	23	IXYH 80N90C3	26	IXYT 30N450HV	4, 31	>LSIC2SD065C20A	72
IXYA 20N65C3	23	IXYH 82N120C3	26	>IXYT 40N120A4HV	4, 25	>LSIC2SD065D06A	2, 72
IXYA 20N65C3D1	23	>IXYH 85N120A4	25	>IXYT 55N120A4HV	4, 25	>LSIC2SD065D08A	2, 72
IXYA 20N120A4HV	3, 25	>IXYH 100N65A3	23	IXYT 80N90C3	26	>LSIC2SD065D10A	2, 72
>IXYA 20N120B4HV	3, 25	IXYH 100N65B3	23	>IXYT 85N120A4HV	4, 25	>LSIC2SD065D16A	2, 72
IXYA 20N120C3HV	3, 26	IXYH 100N65C3	23	IXYX 25N250CV1	27	>LSIC2SD065D20A	2, 72
>IXYA 20N120C4HV	3, 25	IXYH 120N65B3	23	IXYX 25N250CV1HV	5, 27	>LSIC2SD065E12CCA	72
IXYA 30N120A4HV	3, 25	IXYH 120N65C3	23	IXYX 30N170CV1	5, 27	>LSIC2SD065E16CCA	72
IXYA 50N65C3	23	IXYH 120N65C3D1	23	IXYX 40N250CHV	5, 27	>LSIC2SD065E20CCA	72
IXYB 82N120C3H1	26	IXYK 30N170CV1	27	IXYX 40N450HV	5, 31	>LSIC2SD065E32CCA	72
IXYF 16N250CV1	16, 27	IXYK 100N65B3D1	23	IXYX 50N170C	27	>LSIC2SD065E40CCA	72
IXYF 30N170CV1	16, 27	IXYK 100N65C3D1	23	IXYX 100N65B3D1	23	◇LSIC2SD065N128PA	72
IXYF 30N450	16, 31	IXYK 100N120B3	26	IXYX 100N65C3D1	23	◇LSIC2SD065N40PA	72
IXYF 40N450	16, 31	IXYK 100N120C3	26	IXYX 100N120B3	26	◇LSIC2SD065N80PA	72
IXYH 8N250CHV	5, 27	IXYK 120N120B3	26	IXYX 100N120C3	26	LSIC2SD120A05	72
IXYH 8N250CV1HV	5, 27	IXYK 120N120C3	26	IXYX 120N120B3	26	LSIC2SD120A08	72
IXYH 10N170C	27	IXYK 140N90C3	26	IXYX 120N120C3	26	LSIC2SD120A10	72
IXYH 10N170CV1	27	>IXYK 140N120A4	25	IXYX 140N90C3	26	LSIC2SD120A15	72
IXYH 12N250CHV	5, 27	IXYK 200N65B3	23	IXYX 140N120A4	25	LSIC2SD120A20	72
IXYH 12N250CV1HV	5, 27	>IXYK 300N65A3	23	>IXYX 140N120A4	25	LSIC2SD120A20A	72
IXYH 16N170C	27	IXYL 40N250CV1	27	IXYX 200N65B3	23	LSIC2SD120C05	72
IXYH 16N170CV1	27	IXYL 50N170CV1	27	>IXYX 300N65A3	23	LSIC2SD120C08	72
IXYH 16N250CV1HV	5, 27	IXYL 60N450	31	IXYY 8N90C3	26	LSIC2SD120C10	72
IXYH 20N65B3	23	IXYN 30N170CV1	27			LSIC2SD120D10	2, 72
IXYH 20N65C3	23	IXYN 50N170CV1	27	L		LSIC2SD120D15	2, 72
IXYH 20N120C3	26	IXYN 75N65C3D1	23	L0103NERP	114	LSIC2SD120D20	2, 72
IXYH 20N120C3D1	26	IXYN 80N90C3H1	26	L0107NTRP	114	LSIC2SD120E10CC	72
IXYH 24N90C3	26	IXYN 82N120C3	26	L0109NERP	114	LSIC2SD120E15CC	72
IXYH 24N90C3D1	26	IXYN 82N120C3H1	26	LJ6004D8RP	114	LSIC2SD120E20CC	72
IXYH 24N170C	27	IXYN 100N65A3	23	○LKK 47-06C5	70	LSIC2SD120E30CC	72
IXYH 24N170CV1	27	IXYN 100N65B3D1	23	◇LSIC1MO120N0025	71	LSIC2SD120E40CC	72
IXYH 24N170CV1HV	5, 27	IXYN 100N65C3H1	23	◇LSIC1MO120E0025	71	>LSIC2SD120N120PA	72
IXYH 25N250CHV	5, 27	IXYN 100N120B3H1	26	◇LSIC1MO120E0040	71	>LSIC2SD120N40PA	72
IXYH 30N65B3D1	23	IXYN 100N120C3	26	LSIC1MO120E0080	71	>LSIC2SD120N80PA	72
IXYH 30N65C3	23	IXYN 100N120C3H1	26	LSIC1MO120E0120	71	LX807MBRP	114
IXYH 30N65C3H1	23	IXYN 100N120C3D1	26	LSIC1MO120E0160	71	LX807MTRP	114
IXYH 30N120A4	25	IXYN 120N65B3D1	23	◇LSiC1MO120G0025	7, 71	M	
>IXYH 30N120B4	25	IXYN 120N65C3D1	23	◇LSiC1MO120G0040	7, 71	>MCB 20P1200LB	11, 73
IXYH 30N120C3	26	IXYN 120N120C3	26	◇LSiC1MO120G0080	7, 71	>MCB 30P1200LB	11, 73
IXYH 30N120C3D1	26	>IXYN 140N120A4	25	◇LSiC1MO120G0120	7, 71	◇MCB 35P1700TLB	11, 73
>IXYH 30N120C4	25	>IXYN 300N65A3	23	◇LSiC1MO120G0160	7, 71	>MCB 40P1200LB	11, 73
		IXYP 8N90C3	26	◇LSIC1MO120T0080	71		

Alphanumeric Index

- New
- Not for new design
- ✦ Under development

➤ MCB 60I1200TZ	4, 73	MCC 95-16io8B	101	MCD 56-18io1B	97	MCMA 35P1200TA	100
✦ MCB 60P1200TLB	11, 73	MCC 95-18io1B	101	MCD 56-18io8B	97	MCMA 35P1600TA	100
MCC 19-08io1B	100	MCC 95-18io8B	101	MCD 72-08io1B	98	MCMA 35PD1200TB	97
MCC 19-08io8B	100	MCC 132-08io1	101	MCD 72-08io8B	98	MCMA 35PD1600TB	97
MCC 19-12io1B	100	MCC 132-12io1	101	MCD 72-12io1B	98	MCMA 50P1200TA	100
MCC 19-12io8B	100	MCC 132-14io1	101	MCD 72-12io8B	98	MCMA 50P1600TA	100
MCC 19-14io1B	100	MCC 132-16io1	101	MCD 72-14io1B	98	MCMA 50PD1200TB	97
MCC 19-14io8B	100	MCC 132-18io1	101	MCD 72-14io8B	98	MCMA 50PD1600TB	97
MCC 19-16io1B	100	MCC 161-20io1	102	MCD 72-16io1B	98	MCMA 65P1200TA	101
MCC 19-16io8B	100	MCC 161-22io1	102	MCD 72-16io8B	98	MCMA 65P1600TA	101
MCC 21-08io8B	100	MCC 162-08io1	102	MCD 72-18io1B	98	MCMA 65P1800TA	101
MCC 21-12io8B	100	MCC 162-12io1	102	MCD 72-18io8B	98	MCMA 65PD1200TB	97
MCC 21-14io8B	100	MCC 162-14io1	102	MCD 94-20io1B	98	MCMA 65PD1600TB	97
MCC 21-16io8B	100	MCC 162-16io1	102	MCD 94-22io1B	98	MCMA 65PD1800TB	97
MCC 26-08io1B	100	MCC 162-18io1	102	MCD 95-08io1B	98	MCMA 85P1200TA	101
MCC 26-08io8B	100	MCC 200-14io1	102	MCD 95-08io8B	98	MCMA 85P1600TA	101
MCC 26-12io1B	100	MCC 200-16io1	102	MCD 95-12io1B	98	MCMA 85P1800TA	101
MCC 26-12io8B	100	MCC 200-18io1	102	MCD 95-12io8B	98	MCMA 85PD1200TB	98
MCC 26-14io1	100	MCC 224-20io1	102	MCD 95-14io1B	98	MCMA 85PD1600TB	98
MCC 26-14io1B	100	MCC 224-22io1	102	MCD 95-14io8B	98	MCMA 85PD1800TB	98
MCC 26-14io8B	100	MCC 224-24io1	102	MCD 95-16io1	98	MCMA 110P1200TA	101
MCC 26-16io1B	100	MCC 225-12io1	102	MCD 95-16io1B	98	MCMA 110P1600TA	101
MCC 26-16io8B	100	MCC 225-14io1	102	MCD 95-16io8B	98	MCMA 110P1600VA	101
MCC 44-08io1B	100	MCC 225-16io1	102	MCD 95-18io1B	98	MCMA 110P1800TA	101
MCC 44-08io8B	100	MCC 225-18io1	102	MCD 95-18io8B	98	MCMA 110PD1200TB	98
MCC 44-12io1B	100	MCC 255-12io1	102	MCD 132-08io1	98	MCMA 110PD1600TB	98
MCC 44-12io8B	100	MCC 255-14io1	102	MCD 132-12io1	98	MCMA 110PD1800TB	98
MCC 44-14io1B	100	MCC 255-16io1	102	MCD 132-14io1	98	MCMA 120UJ1800ED	112
MCC 44-14io8B	100	MCC 255-18io1	102	MCD 132-16io1	98	MCMA 140P1200TA	101
MCC 44-16io1B	100	MCC 310-08io1	102	MCD 132-18io1	98	MCMA 140P1400TA	101
MCC 44-16io8B	100	MCC 310-12io1	102	MCD 161-20io1	99	MCMA 140P1600TA	101
MCC 44-18io1B	100	MCC 310-14io1	102	MCD 161-22io1	99	MCMA 140P1800TA	101
MCC 44-18io8B	100	MCC 310-16io1	102	MCD 162-08io1	99	MCMA 140PD1200TB	98
MCC 56-08io1B	100	MCC 310-18io1	102	MCD 162-12io1	99	MCMA 140PD1600TB	98
MCC 56-08io8B	100	MCC 312-12io1	102	MCD 162-14io1	99	MCMA 140PD1600TB-NI	98
MCC 56-12io1B	100	MCC 312-14io1	102	MCD 162-16io1	99	MCMA 140PD1800TB	98
MCC 56-12io8B	100	MCC 312-16io1	102	MCD 162-18io1	99	➤ MCMA 160P1600YA	102
MCC 56-14io1	100	MCC 312-18io1	102	MCD 200-14io1	99	➤ MCMA 160P1800YA-MI	102
MCC 56-14io1B	100	MCD 26-08io1B	97	MCD 200-16io1	99	MCMA 200P1600SA	102
MCC 56-14io8B	100	MCD 26-08io8B	97	MCD 200-18io1	99	➤ MCMA 200P1600YA	102
MCC 56-16io1B	100	MCD 26-12io1B	97	MCD 224-20io1	99	➤ MCMA 200P1800YA-MI	102
MCC 56-16io8B	100	MCD 26-12io8B	97	MCD 224-22io1	99	MCMA 200PD1600SA	99
MCC 56-18io1B	100	MCD 26-14io1B	97	MCD 225-12io1	99	MCMA 240UI1600ED	111
MCC 56-18io8B	100	MCD 26-14io8B	97	MCD 225-14io1	99	MCMA 240UI1600PED	1, 111
MCC 72-08io1B	101	MCD 26-16io1B	97	MCD 225-16io1	99	MCMA 245UI1600ED	111
MCC 72-08io8B	101	MCD 26-16io8B	97	MCD 225-18io1	99	MCMA 260P1600YA	102
MCC 72-12io1B	101	MCD 40-12io6	97	MCD 255-12io1	99	MCMA 260P1800YA	102
MCC 72-12io8B	101	MCD 40-16io6	97	MCD 255-14io1	99	MCMA 260PD1600YB	99
MCC 72-14io1B	101	MCD 44-08io1B	97	MCD 255-16io1	99	MCMA 260PD1800YB	99
MCC 72-14io8B	101	MCD 44-08io8B	97	MCD 255-18io1	99	MCMA 265P1600KA	102
MCC 72-16io1B	101	MCD 44-12io1B	97	MCD 310-08io1	99	MCMA 265P1800KA	102
MCC 72-16io8B	101	MCD 44-12io8B	97	MCD 310-12io1	99	MCMA 265PD1600KB	99
MCC 72-18io1B	101	MCD 44-14io1B	97	MCD 310-14io1	99	MCMA 265PD1800KB	99
MCC 72-18io8B	101	MCD 44-14io8B	97	MCD 310-16io1	99	➤ MCMA 280P1600PTSF	102
MCC 94-20io1B	101	MCD 44-16io1B	97	MCD 310-18io1	99	➤ MCMA 280PD1600PTSF	99
MCC 94-22io1B	101	MCD 44-16io8B	97	MCD 310-20io1	99	MCMA 400P1600PTSF	1, 102
MCC 94-24io1B	101	MCD 44-18io1B	97	MCD 310-22io1	99	MCMA 400PD1600PTSF	1, 99
MCC 95-08io1B	101	MCD 44-18io8B	97	MCD 312-12io1	99	MCMA 450UH1600TEH	112
MCC 95-08io8B	101	MCD 56-08io1B	97	MCD 312-14io1	99	MCMA 550P1600PTSF	1, 102
MCC 95-12io1B	101	MCD 56-08io8B	97	MCD 312-16io1	99	MCMA 550PD1600PTSF	1, 99
MCC 95-12io8B	101	MCD 56-12io1B	97	MCD 312-18io1	99	MCMA 650MT1400NKD	113
MCC 95-14io1	101	MCD 56-12io8B	97	MCK 200-18io1	102	MCMA 650MT1800NKD	113
MCC 95-14io1B	101	MCD 56-14io1B	97	MCMA 25P1200TA	100	MCMA 700P1600CA	102
MCC 95-14io8B	101	MCD 56-14io8B	97	MCMA 25P1600TA	100	MCMA 700P1600NCA	102
MCC 95-16io1	101	MCD 56-16io1B	97	MCMA 25PD1200TB	97	MCMA 700P1800CA	102
MCC 95-16io1B	101	MCD 56-16io8B	97	MCMA 25PD1600TB	97	MCMA 700P1800NCA	102

Alphanumeric Index

> New
 ○ Not for new design
 ◇ Under development

MCMA 700PD1600CB	99	MDD 72-12N1B	94	MDMA 140P1600TG	95	MEK 600-04DA	86
MCMA 700PD1800CB	99	MDD 72-14N1B	94	MDMA 140P1800TG	95	MEO 450-12DA	86
MCNA 40P2200TA	100	MDD 72-16N1B	94	> MDMA 150U1600VA	109	MEO 500-06DA	86
MCNA 40PD2200TB	97	MDD 72-18N1B	94	> MDMA 180P1600YD	95	MEO 550-02DA	86
MCNA 55P2200TA	101	MDD 95-08N1B	95	MDMA 200P1600SA	95	> MG06100S-BN4MM	40
MCNA 55PD2200TB	97	MDD 95-12N1B	95	MDMA 210P1600YD	95	> MG06150S-BN4MM	40
MCNA 75P2200TA	101	MDD 95-14N1B	95	MDMA 210UB1600PTED	1, 111	> MG06200S-BN4MM	40
MCNA 75PD2200TB	98	MDD 95-16N1B	95	MDMA 240UB1600ED	111	> MG06300D-BN4MM	40
MCNA 95P2200TA	101	MDD 95-18N1B	95	MDMA 280P1600YD	96	> MG06400D-BN4MM	40
MCNA 95PD2200TB	98	MDD 95-20N1B	95	MDMA 280UB1600PTED	1, 111	> MG0675S-BN4MM	40
MCNA 120P2200TA	101	MDD 95-22N1B	95	> MDMA 300P1600PTSF	96	> MG12100S-BN2MM	40
MCNA 120PD2200TB	98	MDD 142-08N1	95	MDMA 360UB1600PTED	1, 111	> MG12150S-BN2MM	40
MCNA 120PD2200TB-NI	98	MDD 142-12N1	95	> MDMA 360UC1600TED	112	> MG12200D-BN2MM	40
> MCNA 120UI2200PED	111	MDD 142-14N1	95	MDMA 380P1600KC	96	> MG12300D-BN2MM	40
MCNA 120UI2200TED	111	MDD 142-16N1	95	MDMA 380P1800KC	96	> MG12400D-BN2MM	40
MCNA 150P2200YA	102	MDD 142-18N1	95	MDMA 425P1600PTSF	96	> MG17100D-BN4MM	40
MCNA 150PD2200YB	99	MDD 172-08N1	95	MDMA 450U1600PTEH	1, 110	> MG17100S-BN4MM	40
MCNA 180P2200YA	102	MDD 172-12N1	95	MDMA 450UB1600PTED	111	> MG17150D-BN4MM	40
MCNA 180PD2200YB	99	MDD 172-14N1	95	> MDMA 450UB1600PTEH	111	> MG17200D-BN4MM	40
MCNA 220P2200YA	102	MDD 172-16N1	95	MDMA 600P1600PTSF	1, 96	> MG17300D-BN4MM	40
MCNA 220PD2200YB	99	MDD 172-18N1	95	MDMA 660U1600PTEH	1, 110	> MG1750S-BN4MM	40
> MCNA 250P2200PTSF	102	MDD 175-28N1	95	MDMA 700P1600CC	96	> MG1775S-BN4MM	40
> MCNA 250PD2200PTSF	99	MDD 175-34N1	95	MDMA 700P1800CC	96	○ MIEB 100W1200DPFTEH	37
MCNA 360P2200PTSF	1, 102	MDD 200-14N1	95	MDMA 900U1600PTEH	1, 110	○ MIEB 101W1200TEH	37
MCNA 360PD2200PTSF	1, 99	MDD 200-16N1	95	MDNA 25P2200TG	94	○ MITA 300RF1700PTED	39
MCNA 500P2200PTSF	1, 102	MDD 200-18N1	95	MDNA 35P2200TG	94	> MITA 300RF1700PTED-PC	39
MCNA 500PD2200PTSF	1, 99	MDD 200-22N1	95	MDNA 50P2200TG	94	MIXA 10WB1200TED	34
MCNA 650P2200CA	102	MDD 255-12N1	96	MDNA 65P2200TG	94	MIXA 20WB1200TED	34
MCNA 650PD2200CB	99	MDD 255-14N1	96	MDNA 85P2200TG	94	MIXA 30WB1200TED	36
MCO 25-12io1	103	MDD 255-16N1	96	MDNA 110P2200TG	95	MIXA 30WB1200TED	34
MCO 25-16io1	103	MDD 255-18N1	96	MDNA 140P2200TG	95	MIXA 40W1200TED	36
MCO 50-12io1	103	MDD 255-20N1	96	> MDNA 180P2200YD	95	MIXA 40WB1200TED	34
MCO 50-16io1	103	MDD 255-22N1	96	> MDNA 210P2200YD	95	> MIXA 41W1200ED	36
MCO 75-12io1	103	MDD 310-12N1	96	MDNA 210UB2200PTED	111	MIXA 60HU1200VA	39
MCO 75-16io1	103	MDD 310-14N1	96	> MDNA 210UB2200TED	111	MIXA 60W1200TED	36
MCO 100-12io1	103	MDD 310-16N1	96	MDNA 240U2200ED	110	MIXA 60WB1200TEH	35
MCO 100-16io1	103	MDD 310-18N1	96	> MDNA 280P2200YD	96	MIXA 60WH1200TEH	35
MCO 150-12io1	103	MDD 310-20N1	96	MDNA 280UB2200PTED	111	○ MIXA 61H1200ED	39
MCO 150-16io1	103	MDD 310-22N1	96	MDNA 300P2200PTSF	96	MIXA 80R1200VA	39
MCO 450-20io1	103	MDD 312-12N1	96	MDNA 360UB2200PTED	111	MIXA 80W1200TED	36
MCO 450-22io1	103	MDD 312-14N1	96	MDNA 380P2200KC	96	MIXA 80W1200TEH	37
MCO 500-12io1	103	MDD 312-16N1	96	MDNA 425P2200PTSF	96	MIXA 80WB1200TEH	35
MCO 500-14io1	103	MDD 312-18N1	96	MDNA 600P2200PTSF	1, 96	○ MIXA 81H1200EH	39
MCO 500-16io1	103	MDD 312-20N1	96	MDNA 660U2200PTEH	1, 110	◇ MIXA 81WB1200TEH	35
MCO 500-18io1	103	MDD 312-22N1	96	MDNA 700P2200CC	96	MIXA 100W1200TEH	37
MCO 600-16io1	103	MDMA 25P1200TG	94	MDO 500-12N1	96	MIXA 150Q1200VA	39
MCO 600-18io1	103	MDMA 25P1600TG	94	MDO 500-14N1	96	MIXA 150R1200VA	39
MCO 600-20io1	103	MDMA 25P1800TG	94	MDO 500-16N1	96	MIXA 150W1200TEH	37
MCO 600-22io1	103	MDMA 35P1200TG	94	MDO 500-18N1	96	MIXA 225PF1200TSF	38
MDA 95-22N1B	95	MDMA 35P1600TG	94	MDO 500-20N1	96	> MIXA 225RF1200TSF	38
MDD 26-08N1B	94	MDMA 35P1800TG	94	MDO 500-22N1	96	MIXA 300PF1200TSF	38
MDD 26-12N1B	94	MDMA 50P1200TG	94	MDO 600-16N1	96	MIXA 450PF1200TSF	38
MDD 26-14N1B	94	MDMA 50P1600TG	94	MEA 75-12DA	86	> MIXG 70W1200TED	36
MDD 26-16N1B	94	MDMA 50P1800TG	94	MEA 95-06DA	86	MIXG 120W1200DPFTEH	37
MDD 26-18N1B	94	MDMA 60UC1600VC	112	MEA 250-12DA	86	MIXG 120W1200PTEH	1, 37
MDD 44-08N1B	94	MDMA 65P1200TG	94	MEA 300-06DA	86	◇ MIXG 120W1200PTEH-PC	37
MDD 44-12N1B	94	MDMA 65P1600TG	94	MEE 75-12DA	86	◇ MIXG 120W1200STEH	37
MDD 44-14N1B	94	MDMA 65P1800TG	94	MEE 95-06DA	86	MIXG 120W1200TEH	37
MDD 44-16N1B	94	MDMA 85P1200TG	94	MEE 250-12DA	86	MIXG 180W1200PTEH	1, 37
MDD 44-18N1B	94	MDMA 85P1600TG	94	MEE 300-06DA	86	> MIXG 180W1200PTEH-PC	37
MDD 56-08N1B	94	MDMA 85P1800TG	94	MEK 75-12DA	86	◇ MIXG 180W1200STEH	37
MDD 56-12N1B	94	MDMA 110P1200TG	95	MEK 95-06DA	86	MIXG 180W1200TEH	37
MDD 56-14N1B	94	MDMA 110P1600TG	95	MEK 150-04DA	86	> MIXG 240RF1200PTED	39
MDD 56-16N1B	94	MDMA 110P1800TG	95	MEK 250-12DA	86	> MIXG 240RF1200PTED-PC	39
MDD 56-18N1B	94	> MDMA 120U1600VA	109	MEK 300-06DA	86	◇ MIXG 240RF1200TED	39
MDD 72-08N1B	94	MDMA 140P1200TG	95	MEK 350-02DA	86	MIXG 240W1200PTEH	1, 37

Alphanumeric Index

- New
- Not for new design
- ◇ Under development

◇ MIXG 240W1200PTEH-PC	37	◇ MTC 120WX75GD	14	➤ QJ8040KH5TP	114	VBO 22-16NO8	106
➤ MIXG 240W1200PZTEH	37	MTI 85W100GC	14	QK040J7TP	114	VBO 22-18NO8	106
MIXG 240W1200PZTEH-PC	37	◇ MTI 85WX100GD	14	QK040K4TP	114	VBO 25-08NO2	106
MIXG 240W1200TEH	37	MTI 145WX100GD	14	S		VBO 25-12AO2	106
◇ MIXG 240W1200ZTEH	37	MTI 200WX75GD	14	S6002TSRP	92	VBO 25-12NO2	106
MIXG 300PF1700TSF	38	○ MUBW 15-12A7	34	S6004DS2RP	92	VBO 25-16AO2	106
➤ MIXG 360PF1200PSTED	34	○ MUBW 25-12A7	34	S601ERP	92	VBO 25-16NO2	106
➤ MIXG 360PF1200PSTED-PC	34	○ MUBW 35-12A7	34	S602ECSR	92	VBO 30-08NO7	106
MIXG 360RF1200PTED-PC	39	○ MUBW 50-12A8	35	S602TSRP	92	VBO 30-12NO7	106
➤ MIXG 360RF1200TED	39	MUBW 50-17T8	35	S6X8BBSRP	92	VBO 30-16NO7	106
MIXG 450PF1700TSF	38	MUBW 50-17T8-PFPC	1, 35	S8008DRP	92	VBO 30-18NO7	106
◇ MIXG 450RF1700TSF	38	MUBW 70-17T8-PFPC	1, 35	S8015LTP	92	VBO 36-08NO8	106
MKE 38P600LB	11, 70	○ MUBW 75-12T8	35	S8025LTP	92	VBO 36-12NO8	106
MKE 38RK600DFELB	11, 70, 75	MUBW 75-17T8	35	S8025RTP	92	VBO 36-16NO8	106
◇ MKH 17RP650DCGLB	11, 70, 73, 75	○ MWI 15-12A7	36	S802ECSR	92	VBO 36-18NO8	106
○ MKI 50-12F7	39	○ MWI 25-12A7	36	S8040RTP	92	VBO 40-08NO6	106
MKI 100-12F8	39	○ MWI 50-12T7T	36	S8055RTP	92	VBO 40-12NO6	106
➤ MMIX 1B15N300C	12	○ MWI 75-12T7T	36	S8065JTP	92	VBO 40-16NO6	106
➤ MMIX 1B20N300C	12	○ MWI 100-12A8	37	S8X5ECSR	92	VBO 50-08NO7	106
MMIX 1F40N110P	11	➤ MXB 12R650DCGFC	73, 75	S8X8TSRP	92	VBO 50-12NO7	106
MMIX 1F44N100Q3	11	➤ MXB 40P650LB	11, 70	SJ6004DS2RP	92	VBO 50-16NO7	106
MMIX 1F132N50P3	11	➤ MXB 40RK600DFELB	11, 70, 75	SJ6008DRP	92	VBO 50-18NO7	106
MMIX 1F160N30T	11	N		SJ6008DS2RP	92	VBO 52-08NO7	106
MMIX 1F180N25T	11	nanoASMD016F-2	20	SJ6012DRP	92	VBO 52-12NO7	106
MMIX 1F210N30P3	11	NGB15N41ACLT4G	20	SJ6012NRP	92	VBO 52-16NO7	106
MMIX 1F230N20T	11	NGB18N40ACLT4G	20	SJ6025L2TP	92	VBO 52-18NO7	106
MMIX 1F360N15T2	11	NGB8202ANT4G	20	SJ6025R2TP	92	VBO 54-08NO7	106
MMIX 1F420N10T	11	NGB8204ANT4G	20	SJ6040LTP	92	VBO 54-12NO7	106
MMIX 1F520N075T2	11, 46	NGB8206ANTF4G	20	SJ6040N2RP	92	VBO 54-16NO7	106
MMIX 1G75N250	12	NGB8207ABNT4G	20	SJ6040RTP	92	VBO 68-08NO7	106
MMIX 1G120N120A3V1	12	NGB8207BNT4G	20	SK025NRP	92	VBO 68-12NO7	106
MMIX 1H60N150V1	13	NGB8245NT4G	20	SK065KTP	92	VBO 68-16NO7	106
MMIX 1T132N50P3	11, 55	NGD15N41ACLT4G	20	SLD8S	20	VBO 72-08NO7	106
MMIX 1T550N055T2	11, 46	NGD18N40ACLT4G	20	➤ SV6016R2TP	92	VBO 72-12NO7	106
MMIX 1T600N04T2	11, 46	NGD18N45CLBT4G	20	➤ SV6020R2TP	92	VBO 72-16NO7	106
MMIX 1Y82N120C3H1	12	NGD8201ANT4G	20	➤ SV6025L2TP	92	VBO 72-18NO7	106
MMIX 1Y100N120C3H1	12	NGD8201BNT4G	20	➤ SV6025R2TP	92	VBO 78-08NO7	107
MMIX 2F60N50P3	11	NGD8205ANT4G	20	T		VBO 78-12NO7	107
MMIX 2F94N30T	11	NGD8209NT4G	20	TPSMB	20	VBO 78-16NO7	107
MMIX 2F150N20T	11	Q		TPSMB-VR	20	VBO 88-08NO7	107
MMIX 4G20N250	12	Q6012LH1LEDTP	114	TPSMC	20	VBO 88-12NO7	107
MMIX 1X100N60B3H1	12	Q6035NH5RP	114	TPSMD	20	VBO 88-16NO7	107
MMIX 1X200N60B3	12	Q8004D4RP	114	U		VBO 105-08NO7	107
MMIX 1X200N60B3H1	12	Q8006RH4TP	114	UGB 3132AD	115	VBO 105-12NO7	107
MMIX 1X340N65B4	12	Q8008LH4TP	114	UGB 6124AG	115	VBO 105-16NO7	107
MMJX 1H40N150	13	Q8015LTP	114	UGD 6123AG	115	VBO 125-08NO7	107
MMO 62-12io6	113	Q8025K6TP	114	UGD 8124AG	115	VBO 125-12NO7	107
MMO 62-16io6	113	Q8040K3TP	114	UGE 0221AY4	115	VBO 125-16NO7	107
MMO 74-12io6	113	Q8040K5TP	114	UGE 0421AY4	115	VBO 130-08NO7	107
MMO 74-16io6	113	QJ6004D4RP	114	UGE 1112AY4	115	VBO 130-12NO7	107
MMO 90-12io6	113	QJ6006DH4RP	114	UGE 3126AY4	115	VBO 130-16NO7	107
MMO 90-14io6	113	QJ6008DH4RP	114	V		VBO 130-18NO7	107
MMO 90-16io6	113	QJ6016LH4TP	114	VBE 17-06NO7	105	VBO 160-08NO7	107
MMO 110-12io7	113	QJ6016NH2RP	114	VBE 17-12NO7	105	VBO 160-12NO7	107
MMO 110-14io7	113	QJ6016NH6RP	114	VBE 26-06NO7	105	VBO 160-16NO7	107
MMO 140-12io7	113	QJ6016RH3TP	114	VBE 26-12NO7	105	VBO 160-18NO7	107
MMO 140-16io7	113	QJ6025KH6TP	114	VBE 55-06NO7	105	VCO 132-12io7	103
MMO 175-12io7	113	QJ6025LH5TP	114	VBE 55-12NO7	105	VCO 132-16io7	103
MMO 175-16io7	113	QJ6025NH5RP	114	VBE 60-06A	105	VCO 180-12io7	103
MMO 230-12io7	113	QJ6025RH5TP	114	VBE 60-12A	105	VCO 180-16io7	103
MMO 230-16io7	113	QJ8012LH5TP	114	VBE 100-06NO7	105	VGB 0124AY7a	115
◇ MMPA 60P1000TLA	74	QJ8016LH6TP	114	VBE 100-12NO7	105	VGf 0136AB	115
◇ MMXB 95HX650PTED	74	QJ8016NH4RP	114	VBO 21-08NO7	106	VGO 36-16io7	107
MPK 95-06DA	86	QJ8025LH5TP	114	VBO 21-12NO7	106	VHF 15-08io5	107
➤ MTC 120W55GC	14	QJ8025NH5RP	114	VBO 22-08NO8	106	VHF 15-12io5	107
➤ MTC 120WX55GD	14	➤ QJ8030LH4TP	114	VBO 22-12NO8	106	VHF 15-16io5	107

Alphanumeric Index

➤ New
○ Not for new design
◇ Under development

VHF 25-08io7	107	VUO 36-18NO8	108	VUO 190-08NO7	110	CPC1563	125
VHF 25-12io7	107	VUO 50-08NO3	108	VUO 190-12NO7	110	CPC1580	131
VHF 28-08io5	107	VUO 50-12NO3	108	VUO 190-16NO7	110	CPC1590	131
VHF 28-12io5	107	VUO 50-14NO3	108	VUO 190-18NO7	110	CPC1593	120
VHF 28-16io5	107	VUO 50-16NO3	108	VUO 192-16NO7	110	CPC1593	125
VHF 36-08io5	107	VUO 50-18NO3	108	VVZ 39-08ho7	112	CPC1596	132
VHF 36-12io5	107	VUO 52-08NO1	108	VVZ 39-12ho7	112	CPC1705Y	126
VHF 36-16io5	107	VUO 52-12NO1	108	VVZ 40-12io1	112	CPC1706Y	126
VHFD 37-08io1	107	VUO 52-14NO1	108	VVZ 40-16io1	112	CPC1708J	126
VHFD 37-12io1	107	VUO 52-16NO1	108	VVZ 110-12io7	112	CPC1709J	126
VHFD 37-16io1	107	VUO 52-18NO1	108	VVZ 175-12io7	112	CPC1718J	126
VMM 90-09F	74	VUO 52-20NO1	108	VVZ 175-16io7	112	CPC1726Y	126
○ VMO 1200-01F	74	VUO 52-22NO1	108	VVZB 120-16ioX	111	CPC1727J	126
VTO 39-08ho7	112	VUO 55-12NO7	108	VVZB 135-16ioXT	111	CPC1777J	126
VTO 39-12ho7	112	VUO 55-16NO7	108	VVZB 170-16ioXT	111	CPC1779J	126
VUB 72-12NOXT	111	VUO 55-18NO7	108	○ VVZF 70-16io7	112	CPC1786J	126
VUB 72-16NOXT	111	VUO 60-12NO3	109	VW 2x60-12io1	113	CPC1788J	126
VUB 116-16NOXT	111	VUO 60-14NO3	109	VW 2x60-14io1	113	CPC1906Y	126
VUB 120-16NOX	111	VUO 60-16NO3	109	VW 2x60-16io1	113	CPC1907B	126
VUB 120-16NOXT	111	VUO 60-18NO3	109	VWO 35-08ho7	113	CPC1908J	126
VUB 135-22NO1	111	VUO 62-08NO7	109	VWO 35-12ho7	113	CPC1909J	126
VUB 145-16NOXT	111	VUO 62-12NO7	109			CPC1916Y	126
VUB 160-16NOX	111	VUO 62-14NO7	109	IXYS Beverly		CPC1918J	126
VUB 160-16NOXT	111	VUO 62-16NO7	109	C		CPC1926Y	126
VUC 36-12go2	112	VUO 62-18NO7	109	CPC1002N	124	CPC1927J	126
VUC 36-16go2	112	VUO 64-16NO7	109	CPC1004N	124	CPC1943	127
VUE 22-06NO7	105	VUO 68-08NO7	109	CPC1006N	120	CPC1945G	127
VUE 22-12NO7	105	VUO 68-12NO7	109	CPC1008N	120	CPC1945Y	127
VUE 35-06NO7	105	VUO 68-16NO7	109	CPC1009N	120	CPC1961 Dual	127
VUE 35-12NO7	105	○ VUO 70-16NO7	109	CPC1010N	120	CPC1963	127
VUE 50-12NO1	105	VUO 80-08NO1	109	CPC1014N	120	CPC1964B	128
VUE 75-06NO7	105	VUO 80-12NO1	109	CPC1016N	120	CPC1964BX6	128
VUE 75-12NO7	105	VUO 80-14NO1	109	CPC1017N	120	CPC1965G	127
VUE 130-06NO7	105	VUO 80-16NO1	109	CPC1018N	120	CPC1965Y	127
VUE 130-12NO7	105	VUO 80-18NO1	109	CPC1019N	120	CPC1966	128
VUI 30-12N1	75	VUO 82-08NO7	109	CPC1020N	120	CPC1966B	128
VUI 72-16NOXT	111	VUO 82-12NO7	109	CPC1025N	120	CPC1966BX8	128
○ VUM 24-05N	75	VUO 82-14NO7	109	CPC1030N	120	CPC1966YX6	128
VUM 25-05E	75	VUO 82-16NO7	109	CPC1035N	120	CPC1966YX8	128
○ VUM 33-05N	75	VUO 82-18NO7	109	CPC1106N	123	CPC1967J	126
VUM 33-06PH	75	VUO 84-16NO7	109	CPC1114N	123	CPC1968J	126
VUM 85-05A	75	VUO 86-08NO7	109	CPC1117N	123	CPC1972	127
VUO 25-08NO8	108	VUO 86-12NO7	109	CPC1125N	123	CPC1973Y	126
VUO 25-12NO8	108	VUO 86-16NO7	109	CPC1130N	123	CPC1976	128
VUO 25-14NO8	108	VUO 98-08NO7	109	CPC1135N	123	CPC1976YX6	128
VUO 25-16NO8	108	VUO 98-12NO7	109	CPC1150N	123	CPC1977J	126
VUO 25-18NO8	108	VUO 98-16NO7	109	CPC1225N	120	CPC1978J	126
VUO 28-08NO7	108	VUO 105-12NO7	109	CPC1230N	120	CPC1979J	126
VUO 28-12NO7	108	VUO 105-16NO7	109	CPC1231N	123	CPC1981Y	126
VUO 30-08NO3	108	VUO 105-18NO7	109	CPC1317	120	CPC1983B	126
VUO 30-12NO3	108	VUO 110-08NO7	109	CPC1330	120	CPC1983Y	126
VUO 30-14NO3	108	VUO 110-12NO7	109	CPC1333	123	CPC1983YE	126
VUO 30-16NO3	108	VUO 110-16NO7	109	CPC1335	120	➤ CPC1984Y	126
VUO 30-18NO3	108	VUO 110-18NO7	109	CPC1390	120	CPC1986J	126
VUO 34-08NO1	108	VUO 121-16NO1	110	CPC1393	120	CPC1988J	126
VUO 34-12NO1	108	VUO 122-08NO7	110	CPC1394	120	CPC1998J	128
VUO 34-14NO1	108	VUO 122-12NO7	110	CPC1510	120	CPC2014N	122
VUO 34-16NO1	108	VUO 122-16NO7	110	CPC1510	125	CPC2017N	122
VUO 34-18NO1	108	VUO 125-12NO7	110	CPC1511	120	CPC2025N	122
VUO 35-12NO7	108	VUO 125-16NO7	110	CPC1511	125	CPC2030N	122
VUO 35-16NO7	108	VUO 125-18NO7	110	CPC1540	120	CPC2125N	123
VUO 35-18NO7	108	VUO 160-08NO7	110	CPC1540	125	CPC2317N	124
VUO 36-08NO8	108	VUO 160-12NO7	110	CPC1560	120	CPC2330N	124
VUO 36-12NO8	108	VUO 160-16NO7	110	CPC1560	125	CPC3701	134
VUO 36-14NO8	108	VUO 160-18NO7	110	➤ CPC1561	125	CPC3703	134
VUO 36-16NO8	108	VUO 162-16NO7	110	CPC1563	120	CPC3708	134

Alphanumeric Index

- New
- Not for new design
- ✦ Under development

CPC3710	134	LCA125	120	PLA194	121	E1500NH48P	151
CPC3714	134	LCA125L	120	PLB150	123	➤ E1680NC17F	151
CPC3720	134	LCA127	121	PLB171	123	E1800TC45E	151
CPC3730	134	LCA127L	121	PLB190	123	E2060FF65F	151
CPC3902	134	LCA129	121	PM1204	127	E2400EC45E	151
CPC3909	134	LCA182	121	PM1205	127	E3000EC45E	151
CPC3960	134	LCA210	124	PM1206	127	E4000FD45E	151
CPC3980	134	LCA210L	124	PS1201	127	F	
CPC3982	134	LCA220	124	PS2401	127	F0240YC250	150
CPC40055ST	128	LCA701	121	PS2601	127	F0240YC300	150
CPC5001	135	LCA710	121	X		F0240YH250	150
CPC5002	135	LCA712	121	XAA117	122	F0240YH300	150
CPC5902	136	LCA715	121	XAA170	122	F0300WC140	150
CPC5903	136	LCA717	121	XBB170	123	F0300WC180	150
F		LCB110	123	XCA170	121	F0800LC140	150
FDA215	131	LCB111	123	XCB170	123	F0800LC180	150
FDA217	131	LCB120	123	IXYS Chippenham		F0900VC450	150
I		LCB126	123	A		F0900VC520	150
➤ IX4310T	129	LCB127	123	A0516YC240	167	F0900VF450	150
IX4340	129	LCB710	123	A0516YC280	167	F0900VF520	150
➤ IX4340NE	129	LCB716	123	A1237NC240	167	F1000LC080	150
➤ IX4351NE	130	LCB717	123	A1237NC280	167	F1000LC120	150
IX4426	129	LCC110	124	C0044BG400SBE	172	F1300NC45P	150
IX4427	129	LCC120	124	C0044BG400SBG	172	F1300NC50P	150
IX4428	129	LOC110	133	C0044BG400SBJ	172	F1300NC55P	150
IXD_602	129	LOC111	133	C0044BG400SBL	172	F1400NC140	150
IXD_604	129	LOC112	133	C0044BG400SBM	172	F1400NC180	150
IXD_604SI	129	LOC117	133	C0044BG400SBN	172	F1500NC200	150
IXD_604SIA	129	LOC210	133	C0044BG400SBP	172	F1500NC250	150
IXD_609	129	LOC211	133	C0044BG400SBQ	172	F1600NC080	150
IXD_609SI	129	O		C0044BG400SBR	172	F1600NC120	150
IXD_614	129	OAA160	122	C0044BG400SBR	172	G	
IXD_614SI	129	OMA160	121	C0044BG400SBS	172	➤ G1000NC45B	168
IXD_630	129	P		C0044BG400SBT	172	G1000QC25B	168
IXD_630M	129	PAA110	122	C0044BG400SBW	172	G1000QC45B	168
L		PAA110L	122	C0044BG400SBZ	172	G2000HF250	168
LAA100	122	PAA127	122	C0044BG400SCA	172	G2000HF450	168
LAA100L	122	PAA132	122	C0044BG400SCB	172	G2500HF250	168
LAA108	122	PAA140	122	C0044BG400SCC	172	G3000TF250	168
LAA110	122	PAA140L	122	C0044BG400SCD	172	G3000TF450	168
LAA110L	122	PAA150	122	C0044BG400SCE	172	➤ G4000EF250	168
LAA120	122	PAA190	122	C0044BG400SCF	172	G4000EF450	168
LAA120L	122	PAA191	122	C0044BG400SCG	172	H	
LAA125	122	PAA193	122	C0044BG400SCH	172	H0500KC200	168
LAA125L	122	PBA150	124	C0044BG400SCH	172	H0500KC20Y	168
LAA127	122	PBB150	123	C0044BG400SCJ	172	H0500KC25D	168
LAA127L	122	PBB190	123	C0044BG400SCK	172	H0500KC25Y	168
LAA710	122	PD1201	127	C0044BG400SCL	172	H0700KC140	168
LBA110	124	PD2401	127	C0044BG400SCM	172	H0700KC14Y	168
LBA110L	124	PD2601	127	C0044BG400SCN	172	H0700KC17D	168
LBA120	124	PLA110	121	C0044BG400SCR	172	H0700KC17Y	168
LBA120L	124	PLA110L	121	C0044BG400SCS	172	H1200NC200	168
LBA127	124	PLA132	121	E		H1200NC20Y	168
LBA127L	124	PLA134	121	E0330MF65F	151	H1200NC25D	168
LBA710	124	PLA140	121	E0460QC45E	151	H1200NC25Y	168
LBA716	124	PLA140L	121	E0660NC45E	151	K	
LBB110	123	PLA143	121	E0660NH45E	151	K0445LG600	158
LBB120	123	PLA150	121	E0770HF65F	151	K0445LG650	158
LBB126	123	PLA160	121	E1000TF65F	151	K0500LC600	158
LBB127	123	PLA170	121	E1250HC45E	151	K0500LC650	158
LCA100	120	PLA171	121	E1375EF65F	151	K0560QE600	158
LCA100L	120	PLA172P	121	➤ E1500MC33E	151	K0560QE650	158
LCA110	120	PLA190	121	E1500NC36P	151	K0625QA600	158
LCA110L	120	PLA191	121	E1500NC42P	151	K0625QA650	158
LCA120	120	PLA192	121	E1500NC48P	151	K0625QA650	158
LCA120L	120	PLA193	121	E1500NH36P	151	K0890NC360	158
				E1500NH42P	151	K0890NC420	158

Alphanumeric Index

> New
 ○ Not for new design
 ◇ Under development

K0900ME600	158	M0268RJ250	147	M0863LC360	148	M2322ZC300	149
K0900ME650	158	M0268SC200	147	M0872LC140	148	M2322ZC400	149
K1010MA600	158	M0268SC250	147	M0872LC180	148	M2322ZD300	149
K1010MA650	158	M0268SJ200	147	M0872LC210	148	M2322ZD400	149
K1121NC320	158	M0268SJ250	147	M0914LC200	145	M2325HA400	145
K1121NC360	158	M0280RC200	147	M0914LC250	145	M2325HA450	145
K1197NC280	158	M0280RC250	147	M0955JK200	148	M2408NC020	146
K1197NC320	158	M0280RJ200	147	M0955JK250	148	M2408NC060	146
◇ K1210MA480	159	M0280RJ250	147	M0955LC200	148	M2408ND020	146
◇ K1210MA520	159	M0280SC200	147	M0955LC250	148	M2408ND060	146
> K1270MA420	159	M0280SC250	147	M1010NC400	145	M2413VC200	149
> K1270MA450	159	M0280SJ200	147	M1010NC450	145	M2413VC250	149
K1495HE600	159	M0280SJ250	147	M1010ND400	145	M2413VF200	149
K1495HE650	159	M0310YH300	148	M1010ND450	145	M2413VF250	149
K1670HA600	159	M0310YH350	148	M1022LC120	149	> M2505MC220	146
K1670HA650	159	M0334RC120	147	M1022LC160	149	> M2505MC250	146
◇ K1785HA420	159	M0334RC200	147	M1022LC200	149	M2639ZC360	146
◇ K1785HA450	159	M0334RJ120	147	M1080LC100	149	M2639ZC420	146
K1947ZC400	159	M0334RJ200	147	M1080LC120	149	M2639ZD360	146
K1947ZC450	159	M0334SC120	147	M1102NC500	149	M2639ZD420	146
K1947ZD400	159	M0334SC200	147	M1102NC600	149	M2698ZC250	146
K1947ZD450	159	M0334SJ120	147	M1102NC500	149	M2698ZC280	146
K2085TE600	159	M0334SJ200	147	M1102ND500	149	M2698ZC350	146
K2085TE650	159	M0336RA120	147	M1102ND600	149	M2698ZC250	146
K2095ZC360	159	M0336RA140	147	M1104NC400	149	M2698ZD280	146
K2095ZC420	159	M0336SA120	147	M1104NC450	149	M2698ZD350	146
K2095ZD360	159	M0336SA140	147	M1104ND400	149	M2698ZD280	146
K2095ZD420	159	M0347WC160	148	M1104ND450	149	M2837VC180	146
K2325TJ600	159	M0347WC200	148	M1163NC400	145	M2837VC250	146
K2325TJ650	159	M0347WC250	148	M1163NC450	145	M2837VF180	146
> K3745EA600	159	M0358WC120	148	M1163NC400	145	M2837VF250	146
> K3745EA650	159	M0358WC180	148	M1163ND400	145	M3560TJ420	149
◇ K4005EA480	159	M0367WC140	148	M1163ND450	145	M3560TJ450	149
◇ K4005EA520	159	M0367WC220	148	M1242NC260	149	M3770ZC200	146
◇ K4215EA420	159	M0367WC280	148	M1242NC360	149	M3770ZC200	146
◇ K4215EA450	159	M0371YH350	148	M1242ND260	149	M3770ZC340	146
		M0371YH450	148	M1242ND360	149	M3770ZD200	146
L		M0433WC120	148	M1494NC160	149	M3770ZD240	146
L0001HC600XXX	187	M0433WC160	148	M1494NC250	149	M3770ZD300	146
L0001NC600XXX	187	M0433WC200	148	M1494ND250	149	M4305TJ240	149
L0001QC600XXX	187	M0437WC080	148	M1494NK160	149	M4305TJ280	149
L0001TC600XXX	187	M0437WC140	148	M1494NK250	149	MCA500-14io1	173
L0001YC600XXX	187	M0451YC120	148	M1502NC200	145	MCA500-18io1	173
L0001ZF600XXX	187	M0451YC160	148	M1502NC250	145	MCA500-22io1	173
		M0451YC200	148	M1502ND200	145	MCA550-12io1	173
M		M0588LC400	145	M1502ND250	145	MCA550-16io1	173
M0130RL200	147	M0588LC450	145	M1565VC400	149	MCA600-22io1W	179
M0130RL250	147	M0659LC400	148	M1565VC450	149	MCA700-14io1W	179
M0130RM200	147	M0659LC450	148	M1565VF400	149	MCA700-18io1W	179
M0130RM250	147	M0710LC560	148	M1565VF450	149	MCC160-30io3	173
M0130SL200	147	M0710LC600	148	M1583VC400	145	MCC160-36io3	173
M0130SL250	147	M0736LC400	148	M1583VC450	145	MCC220-28io3	173
M0130SM200	147	M0736LC450	148	M1583VF400	145	MCC265-24io3	173
M0130SM250	147	M0759YC120	148	M1583VF450	145	MCC320-30io2	173
M0139RL120	147	M0759YC160	148	M1609NC200	145	MCC320-36io2	173
M0139RL180	147	M0759YH120	148	M1609NC260	145	MCC325-14io3	173
M0139RM120	147	M0759YH160	148	M1609ND200	145	MCC325-18io3	173
M0139RM180	147	M0790YC200	145	M1609ND260	145	MCC380-28io2	173
M0139SL120	147	M0790YH200	145	M1858NC120	149	MCC431-20io2	173
M0139SL180	147	M0790YH250	145	M1858NC160	149	MCC431-22io2	173
M0139SM120	147	M0859LC140	148	M1858NC120	149	MCC431-24io2	173
M0139SM180	147	M0859LC160	148	M1858ND160	149	MCC500-14io1	173
M0225YH300	148	M0859LC180	148	M2273VC300	145	MCC500-18io1	173
M0225YH360	148	M0863LC260	148	M2273VC360	145	MCC500-22io1	173
M0225YH450	148	M0863LC300	148	M2273VF300	145	MCC500-30io7	173
M0268RC200	147			M2273VF360	145	MCC500-36io7	173
M0268RC250	147					MCC501-12io2	173
M0268RJ200	147						

Alphanumeric Index

- New
- Not for new design
- ✦ Under development

MCC501-14io2	173	MCR720-14io7	173	MDD275-36N3	177	N1010NC380	153
MCC501-16io2	173	MCR720-18io7	173	MDD410-24N3	177	➤ N1052LC200	153
MCC501-18io2	173	MDA 710-22N2	177	MDD410-28N3	177	➤ N1052LC220	153
MCC550-12io1	173	MDA 710-26N2	177	MDD510-14N3	177	N1075LN180	153
MCC550-16io1	173	MDA 810-12N2	177	MDD510-18N3	177	N1132NC300	153
MCC552-12io2	173	MDA 810-16N2	177	MDD600-14N1	177	N1132NC340	153
MCC552-14io2	173	MDA 810-18N2	177	MDD600-18N1	177	N1132NC360	153
MCC552-16io2	173	MDA1080-18N7	178	MDD600-22N1	177	N1140LN140	153
MCC580-28io7	173	MDA1080-24N7	178	MDD630-30N2	177	N1159NC380	153
MCC600-22io1W	179	MDA1080-28N7	178	MDD630-36N2	177	N1159NC420	153
MCC650-24io7	173	MDA275-30N3	177	MDD950-14N1W	179	N1174JK200	153
MCC700-14io1W	179	MDA275-36N3	177	MDD950-18N1W	179	N1174JK220	153
MCC700-18io1W	179	MDA410-24N3	177	MDD950-22N1W	179	N1263JK160	153
MCC720-14io7	173	MDA410-28N3	177	MDK 710-22N2	177	N1263JK180	153
MCC720-18io7	173	MDA510-14N3	177	MDK 710-26N2	177	○N1351VC400	153
MCD160-30io3	175	MDA510-18N3	177	MDK 810-12N2	178	○N1351VC450	153
MCD160-36io3	175	MDA600-14N1	177	MDK 810-16N2	178	○N1351VF400	153
MCD220-28io3	175	MDA600-18N1	177	MDK 810-18N2	178	○N1351VF450	153
MCD265-24io3	175	MDA600-22N1	177	MDK1080-18N7	178	N1366JK080	153
MCD320-30io2	175	MDA630-30N2	177	MDK1080-24N7	178	N1366JK120	153
MCD320-36io2	175	MDA630-36N2	177	MDK1080-28N7	178	N1366JK140	153
MCD325-14io3	175	MDA950-14N1W	179	MDK275-30N3	177	○N1449QL200	153
MCD325-18io3	175	MDA950-18N1W	179	MDK275-36N3	177	○N1449QL220	153
MCD380-28io2	175	MDA950-22N1W	179	MDK410-24N3	177	N1467NC200	153
MCD431-20io2	175	MDC160-30io3	175	MDK410-28N3	177	N1467NC260	153
MCD431-22io2	175	MDC160-36io3	175	MDK510-14N3	177	N1547NC160	153
MCD431-24io2	175	MDC220-28io3	175	MDK510-18N3	177	N1547NC200	153
MCD500-14io1	175	MDC265-24io3	175	MDK600-14N1	177	○N1581QL160	154
MCD500-18io1	175	MDC320-30io2	175	MDK600-18N1	177	○N1581QL180	154
MCD500-22io1	175	MDC320-36io2	175	MDK600-22N1	177	N1651QK200	154
MCD500-30io7	176	MDC325-14io3	175	MDK630-30N2	177	N1651QK220	154
MCD500-36io7	176	MDC325-18io3	175	MDK630-36N2	177	○N1661VC300	154
MCD501-12io2	175	MDC380-28io2	175	MDK950-14N1W	179	○N1661VC360	154
MCD501-14io2	175	MDC431-20io2	175	MDK950-18N1W	179	○N1661VF300	154
MCD501-16io2	175	MDC431-22io2	175	MDK950-22N1W	179	○N1661VF360	154
MCD501-18io2	175	MDC431-24io2	175	MDO1120-24N1	178	N1718NC120	154
MCD550-12io1	175	MDC500-14io1	175	MDO1120-28N1	178	N1718NC180	154
MCD550-16io1	175	MDC500-18io1	175	MDO1201-14N1	178	N1718NC200	154
MCD552-12io2	176	MDC500-22io1	175	MDO1201-18N1	178	N1725MC320	154
MCD552-14io2	176	MDC500-30io7	176	MDO1201-22N1	178	N1725MC360	154
MCD552-16io2	176	MDC500-36io7	176	➤ MTE1200AD45AA	171	N1802NC120	154
MCD580-28io7	176	MDC501-12io2	175	N		N1802NC160	154
MCD600-22io1W	179	MDC501-14io2	175	N0180SH120	152	N1806QK160	154
MCD650-24io7	176	MDC501-16io2	175	N0180SH160	152	N1806QK180	154
MCD700-14io1W	179	MDC501-18io2	175	N0335SC120	152	○N1817QL080	154
MCD700-18io1W	179	MDC550-12io1	176	N0335SC160	152	○N1817QL120	154
MCD720-14io7	176	MDC550-16io1	176	N0416SC040	152	○N1817QL140	154
MCD720-18io7	176	MDC552-12io2	176	N0416SC080	152	○N2015ML200	154
MCK500-14io1	173	MDC552-14io2	176	N0465WN140	153	○N2015ML220	154
MCK500-18io1	173	MDC552-16io2	176	N0465WN160	153	N2055HE420	154
MCK500-22io1	173	MDC580-28io7	176	N0530YN220	153	N2055HE450	154
MCK550-12io1	173	MDC600-22io1W	179	N0530YN250	153	N2055MC260	154
MCK550-16io1	173	MDC650-24io7	176	N0616LC400	153	N2055MC280	154
MCK600-22io1W	179	MDC700-14io1W	179	N0616LC450	153	N2083QK080	154
MCK700-14io1W	179	MDC700-18io1W	179	N0634LC380	153	N2083QK120	154
MCK700-18io1W	179	MDC720-14io7	176	N0634LC420	153	N2083QK140	154
MCO560-30io1	174	MDC720-18io7	176	N0646LC300	153	N2086NC060	154
MCO560-36io1	174	MDD 710-22N2	177	N0646LC360	153	N2086NC100	154
MCO635-28io1	174	MDD 710-26N2	177	N0795YN140	153	N2154JK020	154
MCO741-22io1	174	MDD 810-12N2	177	N0795YN180	153	N2154JK040	154
MCO801-14io1	174	MDD 810-16N2	177	N0882NC400	153	N2154JK060	154
MCO801-18io1	174	MDD 810-18N2	177	N0882NC450	153	N2172ZC420	154
MCR500-30io7	173	MDD1080-18N7	178	N0910LC200	153	N2172ZC450	154
MCR500-36io7	173	MDD1080-24N7	178	N0910LC260	153	N2172ZD420	154
MCR580-28io7	173	MDD1080-28N7	178	N0910LC280	153	N2172ZD450	154
MCR650-24io7	173	MDD275-30N3	177	N1010NC300	153	○N2191ML160	154

Alphanumeric Index

> New
 ○ Not for new design
 ◇ Under development

○ N2191ML180	154	N3620TE320	156	○ P0128SH10E	160	○ P0848YC04C	161
N2285HA420	154	N3620TE360	156	○ P0128SH12C	160	○ P0848YC06B	161
N2285HA450	154	N3620TJ320	156	○ P0128SH12D	160	○ P0848YC06C	161
N2367MK200	154	N3620TJ360	156	○ P0128SH12E	160	○ P1007LC08D	161
N2367MK220	154	N3790TE240	156	○ P0128SJ10C	160	○ P1007LC08E	161
N2385HE320	154	N3790TE280	156	○ P0128SJ10D	160	○ P1007LC08F	161
N2385HE360	154	N3790TJ240	156	○ P0128SJ10E	160	○ P1007LC12D	161
N2418ZC300	155	N3790TJ280	156	○ P0128SJ12C	160	○ P1007LC12E	161
N2418ZC360	155	N3880ZD160	156	○ P0128SJ12D	160	○ P1007LC12F	161
N2418ZD300	155	N3880ZD180	156	○ P0128SJ12E	160	R	
N2418ZD360	155	N3904HK200	156	○ P0248SC12D	160	R0472YC12E	162
N2500VC120	155	N3904HK220	156	○ P0248SC12E	160	R0472YC12EKER	160
N2500VC160	155	N3930ZC120	156	○ P0273SC12D	160	R0472YC12F	162
N2500VF120	155	N3930ZC160	156	○ P0273SC12E	160	R0472YC12FKER	160
N2500VF160	155	N3930ZD120	156	○ P0273SC12F	160	R0472YC16E	162
○ N2520ML080	155	N3930ZD160	156	○ P0295WC12D	161	R0472YC16EKER	160
○ N2520ML120	155	N4085ZC080	156	○ P0295WC12E	161	R0472YC16F	162
○ N2520ML140	155	N4085ZC120	156	○ P0306SC08A	160	R0472YC16FKER	160
N2543ZC240	155	N4085ZD080	156	○ P0306SC08B	160	R0487YC12D	162
N2543ZC300	155	N4085ZD120	156	○ P0306SC08C	160	R0487YC12E	162
N2543ZD240	155	> N4165EE420	156	○ P0311SC12E	160	R0487YC14D	162
N2543ZD300	155	> N4165EE450	156	○ P0311SC12F	160	R0487YC14E	162
N2593MK160	155	N4316MK020	156	○ P0327WC08C	161	R0577YC12C	162
N2593MK180	155	N4316MK040	156	○ P0327WC08D	161	R0577YC12D	162
N2600MC160	155	N4316MK060	156	○ P0327WC08E	161	R0577YC12E	162
N2600MC180	155	N4340TE180	156	○ P0327WC08F	161	R0633YC12D	162
N2655HA320	155	N4340TE220	156	○ P0327WC12C	161	R0633YC12E	162
N2655HA360	155	N4340TJ180	156	○ P0327WC12D	161	R0633YC12F	162
N2825TE420	155	> N4340TJ180MBR	174	○ P0327WC12E	161	R0717LC14G	162
N2825TE450	155	N4340TJ220	156	○ P0327WC12F	161	R0717LC14H	162
N2825TJ420	155	> N4340TJ220MBR	174	○ P0330SC04A	160	R0717LC16G	162
N2825TJ450	155	N4472HK160	156	○ P0330SC04C	160	R0717LC16H	162
N2830HE260	155	N4472HK180	156	○ P0330SC06A	160	R0736LC20J	162
N2830HE280	155	> N4650EA420	157	○ P0330SC06C	160	R0736LC20K	162
○ N2900QL020	155	> N4650EA450	157	○ P0330SC08A	160	R0736LC22J	162
○ N2900QL040	155	> N4845EE320	157	○ P0330SC08C	160	R0736LC22K	162
○ N2900QL060	155	> N4845EE360	157	○ P0366WC04A	161	R0736LC25J	162
N3012ZC200	155	> N4940HK120	157	○ P0366WC04B	161	R0736LC25K	162
N3012ZC260	155	> N4940HK140	157	○ P0366WC04C	161	R0736LC25L	162
N3012ZD200	155	N5320FE420	157	○ P0366WC06A	161	R0736LC25M	162
N3012ZD260	155	N5320FE450	157	○ P0366WC06B	161	R0809LC10A	162
N3022MK080	155	> N5415EA320	157	○ P0366WC06C	161	R0809LC10B	162
N3022MK120	155	> N5415EA360	157	○ P0366WC08A	161	R0830LC12C	162
N3022MK140	155	> N5715EE240	157	○ P0366WC08B	161	R0830LC12D	162
N3029ZC240	155	> N5715EE280	157	○ P0366WC08C	161	R0830LC12E	162
N3029ZC280	155	N5910FA420	157	○ P0367WC12E	161	R0830LC12F	162
N3029ZD240	155	N5910FA450	157	○ P0367WC12F	161	R0830LC14C	162
N3029ZD280	155	N6012ZD020	157	○ P0389WC04B	161	R0830LC14D	162
N3165HA260	155	N6012ZD040	157	○ P0389WC04C	161	R0830LC14E	162
N3165HA280	155	N6012ZD060	157	○ P0389WC08B	161	R0830LC14F	162
N3175HE160	155	> N6405EA240	157	○ P0389WC08C	161	R0878LC18K	162
N3175HE180	155	> N6405EA280	157	○ P0431SC04B	160	R0878LC18L	162
N3229QK020	156	N6974HK020	157	○ P0431SC04C	160	R0878LC18M	162
N3229QK040	156	N6974HK040	157	○ P0431SC06B	160	R0878LC20K	162
N3229QK060	156	N6974HK060	157	○ P0431SC06C	160	R0878LC20L	162
N3533ZC140	156	> N7585FE240	157	○ P0515WC04B	161	R0878LC20M	162
N3533ZC180	156	> N7585FE280	157	○ P0515WC04C	161	R0878LC21K	162
N3533ZC220	156	> N7905FE180	157	○ P0515WC04D	161	R0878LC21L	162
N3533ZD140	156	> N7905FE220	157	○ P0515WC06B	161	R0878LC21M	162
N3533ZD180	156	> N8440FA240	157	○ P0515WC06C	161	R0929LC12A	162
N3533ZD220	156	> N8440FA280	157	○ P0515WC06D	161	R0929LC12B	162
N3565HA160	156	> N8800FA180	157	○ P0838LC06B	161	R0929LC12C	162
N3565HA180	156	> N8800FA220	157	○ P0838LC06C	161	R0964LC10C	162
○ N3597ML020	156	P		○ P0838LC08B	161	R0964LC10D	162
○ N3597ML040	156	○ P0128SH10C	160	○ P0838LC08C	161	R0964LC10E	162
○ N3597ML060	156	○ P0128SH10D	160	○ P0848YC04B	161	R0964LC12C	162

Alphanumeric Index

- New
- Not for new design
- ✦ Under development

R0964LC12D	162	○ R1280NC25J	164	R2619ZC21J	165	○ R3968FC28N	166
R0964LC12E	162	○ R1280NC25K	164	R2619ZC21K	165	➤ R4680EA24K	166
R0990LC08A	163	○ R1280NC25L	164	R2619ZC21L	165	➤ R4680EA24L	166
R0990LC08B	163	○ R1280NC25M	164	R2619ZC25J	165	➤ R4680EA24M	166
R0990LC08C	163	○ R1331NC10B	164	R2619ZC25K	165	➤ R4680EA28K	166
➤ R1045NC28L	163	○ R1331NC10C	164	R2619ZC25L	165	➤ R4680EA28L	166
➤ R1045NC28M	163	○ R1331NC10D	164	R2619ZD18J	165	➤ R4680EA28M	166
➤ R1045NC32L	163	○ R1331NC12B	164	R2619ZD18K	165	➤ R5145FA42V	166
➤ R1045NC32M	163	○ R1331NC12C	164	R2619ZD18L	165	➤ R5145FA42W	166
R1124NC18J	163	○ R1331NC12D	164	R2619ZD20J	165	➤ R5145FA45V	166
R1124NC18K	163	R1446NC12C	164	R2619ZD20K	165	➤ R5145FA45W	166
R1124NC18L	163	R1446NC12D	164	R2619ZD20L	165	➤ R5370EA18J	166
R1124NC18M	163	R1446NC12E	164	R2619ZD21J	165	➤ R5370EA18K	166
R1124NC20J	163	R1446NC12F	164	R2619ZD21K	165	➤ R5370EA22J	166
R1124NC20K	163	○ R1448NC14H	164	R2619ZD21L	165	➤ R5370EA22K	166
R1124NC20L	163	○ R1448NC14J	164	R2619ZD25J	165	S	
R1124NC20M	163	○ R1448NC18H	164	R2619ZD25K	165	S0300SR12Y	168
R1124NC21J	163	○ R1448NC18J	164	R2619ZD25L	165	S0500KC200	168
R1124NC21K	163	○ R1448NC20H	164	R2620ZC22J	165	S0500KC20Y	168
R1124NC21L	163	○ R1448NC20J	164	R2620ZC22K	165	S0500KC25D	168
R1124NC21M	163	○ R1448NC20K	164	R2620ZC22L	165	S0500KC25Y	168
R1127NC32P	163	○ R1448NC20L	164	R2620ZC25J	165	S0500YC20Y	168
R1127NC32R	163	○ R1448NC20M	164	R2620ZC25K	165	S0500YC25Y	168
R1127NC32S	163	R1605MC20E	164	R2620ZC25L	165	S0700KC140	168
R1127NC32T	163	R1605MC20F	164	R2620ZD22J	165	S0700KC14Y	168
R1127NC34R	163	R1605MC20G	164	R2620ZD22K	165	S0700KC17D	168
R1127NC34S	163	R1605MC20H	164	R2620ZD22L	165	S0700KC17Y	168
R1127NC34T	163	R1605MC20J	164	R2620ZD25J	165	S1200NC200	168
R1127NC36R	163	R1605MC22E	164	R2620ZD25K	165	S1200NC20Y	168
R1127NC36S	163	R1605MC22F	164	R2620ZD25L	165	S1200NC25D	168
R1127NC36T	163	R1605MC22G	164	R2714ZC14H	166	S1200NC25Y	168
R1158NC26N	163	R1605MC22H	164	R2714ZC14J	166	SXB11987HEX	183
R1158NC26P	163	R1605MC22J	164	R2714ZC14K	166	SXB1265FB	183
R1158NC26T	163	R1700MC18E	164	R2714ZC18H	166	SXB1375B	183
R1178NC14E	163	R1700MC18F	164	R2714ZC18J	166	SXB1645FB	183
R1178NC14F	163	R1700MC18G	164	R2714ZC18K	166	SXB1764FG	183
R1178NC14G	163	R1700MC18H	164	R2714ZD14H	166	SXB1920G	183
R1211NC12C	163	R1700MC18J	164	R2714ZD14J	166	SXB2096B	183
R1211NC12D	163	R1700MC21E	164	R2714ZD14K	166	SXB2167FB	183
R1211NC12E	163	R1700MC21F	164	R2714ZD18H	166	SXB2324FG	183
R1271NC12B	163	R1700MC21G	164	R2714ZD18J	166	SXB2939G	183
R1271NC12C	163	R1700MC21H	164	R2714ZD18K	166	SXB3120FG	183
R1271NC12D	163	R1700MC21J	164	○ R3047TC24K	166	SXB3442B	183
R1271NC12E	163	R1955MC14D	165	○ R3047TC24M	166	SXB3529HEXT	183
R1275NC18L	163	R1955MC14E	165	○ R3047TC24N	166	SXB3840HEX	183
R1275NC18M	163	R1955MC14F	165	○ R3047TC28K	166	SXB4264B	183
R1275NC20L	163	R1955MC16D	165	○ R3047TC28M	166	SXB4649HEXT	183
R1275NC20M	163	R1955MC16E	165	○ R3047TC28N	166	SXB4869G	183
R1275NC21L	163	R1955MC16F	165	➤ R3115TJ24J	166	SXB5877HEX	183
R1275NC21M	163	R2075MC12A	165	➤ R3115TJ24K	166	SXB5993G	183
○ R1279NC22J	163	R2075MC12B	165	➤ R3115TJ28J	166	SXB6240HEXT	183
○ R1279NC22K	163	R2075MC12C	165	➤ R3115TJ28K	166	SXB9737HEX	183
○ R1279NC22L	163	➤ R2295HA22F	165	R3370ZC12C	166	SXC1076FB	186
○ R1279NC22M	163	➤ R2295HA22H	165	R3370ZC12D	166	SXC1195FR	186
○ R1279NC25J	163	R2475ZC28M	165	R3370ZC12E	166	SXC1318FB	186
○ R1279NC25K	163	R2475ZC28N	165	R3370ZD12C	166	SXC1464FR	186
○ R1279NC25L	163	R2475ZC28R	165	R3370ZD12D	166	SXC1517FG	186
○ R1279NC25M	163	R2475ZD28M	165	R3370ZD12E	166	SXC1609FB	186
○ R1280NC21J	164	R2475ZD28N	165	○ R3559TC20K	166	SXC1788FR	186
○ R1280NC21K	164	R2475ZD28R	165	○ R3559TC20M	166	SXC1871FG	186
○ R1280NC21L	164	R2619ZC18J	165	○ R3559TC20N	166	SXC2319FG	186
○ R1280NC21M	164	R2619ZC18K	165	○ R3968FC24K	166	T	
○ R1280NC22J	164	R2619ZC18L	165	○ R3968FC24M	166	➤ T0115QC45G	170
○ R1280NC22K	164	R2619ZC20J	165	○ R3968FC24N	166	➤ T0140QC33G	169
○ R1280NC22L	164	R2619ZC20K	165	○ R3968FC28K	166	T0240NB45E	170
○ R1280NC22M	164	R2619ZC20L	165	○ R3968FC28M	166	T0258HF65G	170

Alphanumeric Index

> New
 ○ Not for new design
 ◇ Under development

> T0285NC33E	169	W0925LG560	140	W1975MC650	141	W3697VC280	142
T0340VB45G	170	W0925LG600	140	W1975MC680	141	W3697VF220	142
T0385HF65E	170	W0944WC120	140	W1975MC720	141	W3697VF280	142
> T0425VC33G	169	W0944WC150	140	W1980JK180	141	W3708MC320	142
T0510VB45E	170	W1032LC500	140	W1980JK220	141	W3708MC350	142
T0600AF65G	170	W1032LC560	140	W2054NC420	141	W3708MC350KDN	139
> T0600NC17A	169	W1032LC600	140	W2054NC450	141	W3708MC350KDR	139
T0600TB45A	170	W1060LG420	140	W2058LC100	141	○ W3743ZC400	142
> T0640VC33E	169	W1060LG450	140	W2058LC120	141	○ W3743ZC450	142
> T0710TC33A	169	W106CEC240	144	W2058LC120KBN	139	○ W3743ZC500	142
T0800EB45G	170	W106CEC280	144	W2058LC120KBR	139	○ W3743ZD400	142
T0800TB45E	170	W1074YC200	140	W2058LC120KCN	139	○ W3743ZD450	142
> T0840NC17E	169	W1074YC260	140	W2058LC120KCR	139	○ W3743ZD500	142
T0900AF65E	170	W1074YC320	140	W2058LC140	141	W3841VC300	142
T0900DF65A	170	W1074YH200	140	W2115MC520	141	W3841VC340	142
T0900EB45A	170	W1074YH260	140	W2115MC560	141	W3841VF300	142
T0960VC17G	169	W1074YH320	140	W2115MC600	141	W3841VF340	142
> T1000EC33G	169	> W108CED180	144	W2134NC360	141	W3842MC240	142
> T1000TC33E	169	> W108CED220	144	W2134NC400	141	W3842MC280	142
T1200EB45E	170	W1185LC420	140	W2340JK120	141	W3842MC280KDN	139
T1290BF65A	170	W1185LC450	140	W2340JK150	141	W3842MC280KDR	139
T1375DF65E	170	W1185LC450KBN	139	W2624NC240	141	W3842MC28A	142
> T1440VC17E	169	W1185LC450KBR	139	W2624NC280	141	W3864QK120	142
> T1500EC33E	169	W1185LC450KCN	139	W2624ND240	141	W3864QK150	142
T1600GB45G	170	W1185LC450KCR	139	W2624ND280	141	W3864QK180	142
> T1680TC17G	169	W121CEC180	144	W2820VC420	141	W4096ZC420	142
T1800GB45A	170	W121CEC220	144	W2820VC450	141	W4096ZC450	142
T1890BF65E	170	W1260LG320	140	W2820VF420	141	W4096ZD420	142
> T2000BB45G	170	W1260LG360	140	W2820VF450	141	W4096ZD450	142
> T2000GC33G	169	W1263YC160	140	W2830HE520	141	W4205TE520	142
T2400GB45E	170	W1263YC200KER	138	W2830HE560	141	W4205TE560	142
T2960BB45E	170	W1263YC200KES	138	W2830HE600	141	W4205TE600	142
W		W1263YC220	140	> W2840QA180	141	W4205TJ520	142
W0428RE250	138	W1263YC250	140	> W2840QA220	141	W4205TJ560	142
W0428RE280	138	W1263YC250KER	138	> W2865HA680	141	W4205TJ600	142
W0428RE320	138	W1263YC250KES	138	> W2865HA720	141	> W4295NK200	143
W0428RF250	138	W1263YH160	140	W2899MC480	141	> W4295NK220	143
W0428RF280	138	W1263YH200	140	W3082MC420	141	W4534NC030	143
W0428RF320	138	W1263YH250	140	W3082MC450	141	W4534NC060	143
W0428SE250	138	W1360LG240	140	W3082MC450KDN	139	> W4534ND030	143
W0428SE280	138	W1360LG300	140	W3082MC450KDR	139	> W4534ND060	143
W0428SE320	138	W1411LC320	140	W3090HA520	141	> W4550HA360	143
W0428SF250	138	W1411LC360	140	W3090HA560	141	> W4550HA400	143
W0428SF280	138	W1411LC360KBN	139	W3090HA600	141	W4693QK050	143
W0428SF320	138	W1411LC360KBR	139	○ W3128VC360	141	W4693QK080	143
W0503RC160	138	W1411LC360KCN	139	○ W3128VC400	141	W4693QR050	143
W0503RC200	138	W1411LC360KCR	139	○ W3128VF360	141	W4693QR080	143
W0503RC240	138	W1520NC500	140	○ W3128VF400	141	○ W4713HL300	143
W0503SC160	138	W1520NC600	140	W3270NC180	142	○ W4713HL350	143
W0503SC200	138	W1524LC240	140	W3270NC20A	142	○ W4713HM300	143
W0503SC240	138	W1524LC300	140	W3270NC220	142	○ W4713HM350	143
W0507YH420	140	W1524LC300KBN	139	W3270NC22A	142	W4767MC180	143
W0507YH450	140	W1524LC300KBR	139	W3305QK240	142	W4767MC220	143
W0642WC160	140	W1524LC300KCN	139	W3305QK280	142	W5092ZC320	143
W0642WC200	140	W1524LC300KCR	139	> W3409NK240	142	W5092ZC350	143
W0642WC240	140	W1730JK240	140	> W3409NK280	142	W5092ZD320	143
W0735RA120	138	W1730JK280	140	W3455QK200	142	W5092ZD350	143
W0735RA150	138	W1748LC180	141	W3455QK220	142	W5130MK240	143
W0735SA120	138	W1748LC220KBN	139	W3477MC360	142	W5130MK280	143
W0735SA150	138	W1748LC220KBR	139	W3477MC400	142	W5139TE450	143
W0790LG650	140	W1748LC220KCN	139	W3630TE650	142	W5139TE480	143
W0790LG720	140	W1748LC220KCR	139	W3630TE720	142	W5139TJ450	143
W0880LC650	140	W1748LC250	141	W3630TJ650	142	W5139TJ480	143
W0880LC720	140	W1856NC460	141	W3630TJ720	142	W5282ZC240	143
W0925LG500	140	W1856NC480	141	W3697VC220	142	W5282ZC300	143

Alphanumeric Index

- New
- Not for new design
- ✦ Under development

W5282ZD240	143	XK0550SA056M	188	XK9000SA160M	189	XSL400C2WRP	187
W5282ZD300	143	XK0600DA074M	188	XK9000SA160ML	189	XSL500C2WRP	187
W5334MK200	143	XK0600SA074M	188	XSF30xxxxAN	193	XSL600C2WRP	187
W5334MK220	143	XK0900DA056M	188	XSF46xxxxAN	193	XSNM12H10S	194
W5636MC120	143	XK0900DT056M	188	XSFGAxxxxAN	193	XSNM12H12S	194
W5636MC150	143	XK0900SA056M	188	XSFGxxxxAN	193	XST1000M08P	187
W5636MC150KDN	139	XK1000BA025M	193	XSFHxxxxAN	193	XST1000M10P	187
W5636MC150KDR	139	XK1000DA074M	188	XSFLPxxxxAN	193	XST1000M12P	187
W5696VC100	143	XK1000SA074M	188	XSFTBxxxxAN	193	XST1000M16P	187
W5696VC140	143	XK1100DA076M	188	XSFTCxxxxAN	193	XW076NC16A	194
W5696VF100	143	XK1130DA076M	188	XSFTxxxxAN	193	XW076NC16B	194
W5696VF140	143	XK1130DT076M	188	XSGSCX13	187	XW076NC16BS	194
W5715ED520	143	XK1130SA076M	188	XSK042	190	XW076NC16BT	194
W5715ED560	143	XK1500BA034M	193	XSK042	191	XW076NC16C	194
W5715ED600	143	XK1800DA076M	188	XSK054	190	XW076NC16CT	194
W5838ZC180	143	XK1800DT076M	188	XSK054	191	XW076NC16R	194
W5838ZC220	143	XK1800SA076M	188	XSK056	190	XW076NC16W	194
W5838ZD180	143	XK2000DA114M	188	XSK056	191	XW116ZC20A	194
W5838ZD220	143	XK2000SA114M	188	XSK065	190	XW116ZC20B	194
W5984TE360	144	XK2100DA076M	188	XSK065	191	XW116ZC20C	194
W5984TE400	144	XK2100DA076ML	188	XSK075	190	XW116ZC20R	194
W5984TJ360	143	XK2100SA076M	188	XSK075	191	XW116ZC20W	194
W5984TJ400	143	XK2100SA076ML	188	XSK087	190	XW127EA25A	194
W6262ZC200	144	XK2140DA076M	188	XSK087	191	XW127EA25B	194
W6262ZC240	144	XK2140DA076ML	188	XSK103	190	XW127EC25A	194
W6262ZD200	144	XK2140DT076M	188	XSK103 (2200/3200)	191	XW127EC25B	194
W6262ZD240	144	XK2140DT076ML	188	XSK103 (4000)	191	XW160FC25A	194
W6360EC520	144	XK2140SA076M	188	XSK112	190	XW160FC25B	194
W6360EC560	144	XK2140SA076ML	188	XSK112	191	XW180BA34E	194
W6360EC600	144	XK2500DA114M	188	XSK120	190	XW180BA34F	194
W7032DB020	144	XK2500DA116M	188	XSK120	191	XW180GA34A	194
W7032DB040	144	XK2500DA116ML	188	XSK126	190	XW180GA34B	194
W7045MC030	144	XK2500SA114M	188	XSK126	191	XW180GC34A	194
W7045MC060	144	XK2500SA116M	188	XSK1500DA076038	192	XW180GC34B	194
➤ W8400ED320	144	XK2500SA116ML	188	XSK1500DA076076	192	XW270QA25A	194
➤ W8400ED350	144	XK2700DA076M	188	XSK1500DA076101	192	Y	
W8405ZC100	144	XK2700DT076M	188	XSK160	190	Y200CKC250	167
W8405ZC140	144	XK2700SA076M	188	XSK160	191	Y500CNC250	167
W8405ZD100	144	XK3000DA116M	188	XSK2000DA076038	192		
W8405ZD140	144	XK3000DA116ML	188	XSK2000DA076076	192		
W8570TE180	144	XK3000SA116M	188	XSK2000DA076101	192		
W8570TE220	144	XK3000SA116ML	188	XSK3000DA076038	192		
W8570TJ180	144	XK3060DA140ML	189	XSK3000DA076076	192		
➤ W8570TJ180MBR	178	XK3060SA140ML	189	XSK3000DA076101	192		
W8570TJ220	144	XK3500DA116M	188	XSK3400DA076038	192		
➤ W8570TJ220MBR	178	XK3500DA116ML	188	XSK3400DA076076	192		
W9830TE120	144	XK3500SA116M	188	XSK3400DA076101	192		
W9830TE150	144	XK3500SA116ML	188	XSK3800DA116M076	192		
W9830TJ120	144	XK4000DA116M	189	XSK3800DA116M101	192		
➤ W9830TJ120MBR	178	XK4000DA116ML	189	XSK4400DA116M076	192		
W9830TJ150	144	XK4000SA116M	189	XSK4400DA116M101	192		
➤ W9830TJ150MBR	178	XK4000SA116ML	189	XSK6000DA116M076	192		
X		XK5000DA128M	189	XSK6000DA116M101	192		
XK0450BA019M	193	XK5000DA128ML	189	XSL1000C2WRP	187		
XK0450BA025M	193	XK6120DA180ML	189	XSL1000C2WRT	187		
XK0450BB019M	193	XK6120SA180ML	189	XSL1100C2WRT	187		
XK0450BB025M	193	XK7000DA128M	189	XSL200D8WRC	187		
XK0450DA056M	188	XK7000DA128ML	189	XSL200D8WRCP	187		
XK0450DT056M	188	XK8000DA180ML	189	XSL220C2WRT	187		
XK0450SA056M	188	XK8000SA180ML	189	XSL300C2WRP	187		
XK0550DA056M	188	XK9000DA160M	189	XSL300C2WS	187		
		XK9000DA160ML	189	XSL350C2WRP	187		

a	Acceleration	I_{FM}	Maximum forward current
BV_{CES}	Collector emitter breakdown voltage	I_{FAV}	Average forward current
BV_{DSS}	Drain source breakdown voltage	$I_{F(AV)M}, I_{T(AV)M}$	Maximum average forward current
C_{ies}, C_{iss}	Input capacitance	I_{FLT}	Sink current of fault terminal
C_{oes}, C_{oss}	Output capacitance	I_{FRM}	Maximum repetitive forward current
C_{res}, C_{rss}	Reverse transfer (Miller) capacitance	$I_{F(RMS)}, I_{T(RMS)}$	RMS forward current
d	Duty cycle	I_{FSM}, I_{TSM}	Maximum surge forward current
d_A	Strike distance through air	I_G, I_{GT}	Trigger gate current
$di/dt, -di/dt$	Rate of change of current	I_{GD}	Non-trigger gate current
$(di/dt)_{cr}$	Critical rate of rise of current	I_{GES}	Gate emitter leakage current
$di_F/dt, -di_F/dt$	Rate of change of forward current	I_H	Holding current
d_s	Creep distance on surface	$I_{IN(H)}$	Signal input current (high level)
dv/dt	Rate of rise of voltage	$I_{IN(L)}$	Signal input current (low level)
$(dv/dt)_{cr}$	Critical rate of rise of voltage	I_{ISOL}	RMS current for isolation test
E_{AR}	Repetitive avalanche energy	I_L	Latching current
E_{AS}	Non-repetitive avalanche energy	I_R	Reverse current
E_{off}	Turn-off energy per pulse	I_{RM}	Maximum reverse recovery current
E_{on}	Turn-on energy per pulse	I_{RMS}	RMS current
$E_{rec(off)}$	Reverse recovery losses at turn-off	I_{RRM}	Maximum repetitive reverse current
$F_{(mounting)}$	Required force to mount hole-less discretes on heat sink	I_S	Continuous source current
g_{fs}	Forward transconductance	I_{SM}	Maximum pulsed source current
I_{AR}	Repetitive avalanche current	I^2t	I^2t value for fusing
I_{AVM}	Maximum average forward current	I_{TSM}	Maximum surge on-state current
I_{BO}	Breakover current	K_f	Characteristic factor
$I_{C(on)}$	Short circuit current	K_p	Coeff. for energy per pulse E_p (material constant)
I_C	Collector current	K_T	Temperature coefficient of VBO
I_{C25}	Continuous DC collector current at $T_C = 25^\circ C$	L	Series stray inductance
I_{C90}	Continuous DC collector current at $T_C = 90^\circ C$	M_d	Mounting torque
I_{CES}	Collector emitter leakage current	P_C	Collector power dissipation
I_{CM}	Maximum pulsed collector current	P_D	Power dissipation
I_D	Drain current	P_{GAV}	Average gate power dissipation
I_{DD}	Module supply current, operating mode	$P_{G(AV)M}$	Maximum average gate power dissipation
I_{DD0}	Module supply current, standby mode	P_{GM}	Maximum gate power dissipation
$I_{D(cont)}$	Continuous drain current	P_{RSM}	Maximum surge reverse power dissipation
I_{D25}	Continuous drain current at $T_C = 25^\circ C$	P_{T}, P_{tot}	Total power dissipation
I_{DAV}	Average DC output current	Q_g	Total gate charge
$I_{D(AV)M}$	Maximum average DC output current	Q_{gc}	Gate collector (Miller) charge
I_{DM}	Maximum pulsed drain current	Q_{gd}	Gate drain (Miller) charge
I_{DRM}	Maximum repetitive off-state current	Q_{ge}	Gate emitter charge
$I_{D(RMS)}$	RMS output current	Q_{gs}	Gate source charge
I_{DSS}	Drain source leakage current	Q_r	Reverse recovery charge
I_F, I_T	Forward current	Q_{RM}	Reverse recovery charge (intrinsic diode)
		Q_s	Recovered charge to IRM

Symbols and Terms

RBSOA	Reverse Bias Safe Operating Area	V_{DSM}	Max. non-repetitive forward blocking voltage
R_{DS(on)}	Static drain source on resistance	V_{DSS}	Drain source breakdown voltage
R_{FI}	Radio frequency interference (= EMI)	Version	Various construction designs of products
R_G	Gate resistance	V_F	Forward voltage
R_{GE}	Gate emitter resistance	V_{FLT}	Voltage at fault terminal
r_T	Slope resistance (for power loss calculation only)	V_{FR}	Forward recovery voltage
R_{thCK}, R_{thCH}	Thermal resistance case to heatsink	V_{GD}	Gate non-trigger voltage
R_{thJA}	Thermal resistance junction to ambient	V_{GE}	Gate emitter voltage
R_{thJC}	Thermal resistance junction to case	V_{GE(th)}	Gate emitter threshold voltage
R_{thJK}, R_{thJH}	Thermal resistance junction to heatsink	V_{GEM}	Maximum transient collector gate voltage
R_{thJS}	Thermal resistance junction to heatsink	V_{GES}	Maximum DC gate voltage
R_{thJW}	Thermal resistance junction to water	V_{GS}	Gate source voltage
R_{thKA}	Thermal resistance heatsink to ambient	V_{GS(th)}	Gate threshold voltage
SCSOA	Short Circuit Safe Operating Area	V_{GSM}	Maximum transient gate source voltage
T_{amb}, T_A	Ambient (cooling medium) temperature	V_{GT}	Gate trigger voltage
T_C, T_{case}	Case temperature	V_H	Holding voltage
t_{d(off)}	Turn-off delay time	V_{IN}	Input control voltage
t_{d(on)}	Turn-on delay time	V_{IN(H)}	Input voltage threshold for IGBT turn-on
t_{fi}	Current fall time (inductive load)	V_{IN(L)}	Input voltage threshold for IGBT turn-off
t_{fr}	Forward recovery time	V_{ISOL}	Isolation voltage
t_{FLT}	Overcurrent or short circuit trip delay time	V_R	Reverse voltage
t_{gd}	Gate controlled delay time	V_{RES}	Input voltage threshold for Reset = active
T_J, T_{VJ}	Virtual junction temperature	V_{RGM}	Maximum reverse gate voltage
T_{JM}, T_{VJM}	Maximum virtual junction temperature	V_{RRM}	Maximum repetitive reverse voltage
T_K, T_H, T_S	Heatsink temperature	V_{RSM}	Maximum non-repetitive reverse voltage
T_L	Lead temperature	V_{SD}	Forward voltage drop
T_{S(max)}	Maximum allowable heatsink temperature	V_T	Forward voltage
T_{stg}	Storage temperature	V_{TO}	Threshold voltage (for power loss calculation)
t_p	Pulse time	Z_{thJC}	Transient thermal impedance junction to case
t_q	Turn-off time	Z_{thJK}, Z_{thJH}	Transient thermal impedance junction to heatsink
t_r	Current rise time		
t_{rr}	Reverse recovery time		
t_{rv}	Rise time of collector emitter voltage		
t_{SC}	Short circuit duration		
V_{BO}	Breakover voltage		
V_{CE}	Collector emitter voltage		
V_{CE(sat)}	Collector emitter saturation voltage		
V_{CE(sat)FLT}	Collector emitter saturation voltage to indicate fault		
V_{CEK}	Collector emitter clamp voltage on chip level		
V_{CES}	Collector emitter voltage		
V_{CGR}	Collector gate voltage		
V_{DD}	Module supply voltage		
V_{DD FLT}	Module supply voltage without fault		
V_{DGR}	Drain gate voltage		
V_{DRM}	Maximum repetitive forward blocking voltage		
V_{DS}	Drain source voltage		

Semiconductor Catalog, Edition 2020

© IXYS A Littelfuse Technology 2020
All Rights reserved

Note

As far as patents or other rights of third parties are concerned, liability is only assumed for components per se, not for applications, processes and circuits implemented with components or assemblies. The information describes the type of component and shall not be considered as assured characteristics.

Stress above one or more of the limiting values may cause permanent damage to the device. These are stress ratings only and operation of the device at these or at any other conditions above those given in the characteristics sections of the specification is not implied. Exposure to limiting values for extended periods may affect device reliability. Terms of delivery and rights to change design or specifications are reserved. Changes have been made to earlier published specifications. The data herein supersedes all previously published informations.

Life support applications

IXYS products used in life support appliances, devices, or systems where malfunction of these products can reasonably be expected to result in personal injury must be expressly authorized for such purposes.

Capsule devices - excluding IGBT's

W 0646 W C 15 0

W
M
F
E
N
R
P
K
A
S
H
G
Y

0646
*

W
Y
K
J
L
Q
D
N
M
P
V
H
Z
T
E
F
G

A
B
C
D
E
F
G
H
J
K
L
M
N
R

15

Device type

- Rectifier diode
- Fast/soft recovery diode
- Extra fast diode
- HP Sonic-FRD™
- Phase control thyristor
- Distributed gate thyristor
- Fast turn-off thyristor
- Medium voltage thyristor
- Asymmetric thyristor
- Symmetrical gate turn-off thyristor
- Fast symmetrical gate turn-off thyristor
- Asymmetric gate turn-off thyristor
- Pulse Thyristor

Device nominal current rating

For devices exceeding 9999 Amperes, digit 5 of the part number changes to C (x100)

Electrode diameter

- 19mm
- 25mm
- 29mm
- 32mm
- 34mm
- 38mm
- 44mm ('B' thickness only), 110mm
- 47mm
- 50mm
- 57mm
- 63mm
- 66mm/68mm
- 73mm
- 75mm
- 85mm
- 99mm
- 125mm

Housing type (electrode diameter in brackets)

- 26mm reverse build
- 8mm (D)
- Standard outline - 14mm (W, Y), 16mm (K), 26mm (L, Q, M, T, E), 26.5mm (N), 33mm (V), 36mm (F, G), 37mm (Z)
- 21mm (N), 24mm (V, Z), 26mm (F, G)
- 35mm inverse build (T, M, Q, E)
- 19.5mm (L), 26mm (K, N, V), 35mm (6.5kV Sonic diode)
- 35mm (L, N)
- 14mm (N), 26mm (Y)
- 19.5mm (N), 25.8mm (V), 26mm (T)
- Wespack 14.5mm (J, Q, M, H)
- Wespack 26mm (Q, M)
- Wespack 33mm (H)
- 14mm (W, Y), 26mm (L)
- Wespack 14mm (Q), 26mm (N)

Voltage grade - V_{RRM} , $V_{DRM}/100$

Special code

- 0 t_q code (thyristors), V_{RRM} % of V_{DRM} for Gate turn-off thyristors - See relevant tables
- P PIN diode (Product groups: W, M, F, E)
- R Rotating package (N, K, W)
- A Avalanche rated diode (W)

t_q Code			
0	No code		
A	10	M	70
B	12	N	100
C	15	P	120
D	20	R	140
E	25	S	160
F	30	T	200
G	35	V	250
H	40	W	300
J	50	X	400
K	60	Y	500
L	65	Z	1000

V_{RRM} % of V_{DRM} for GTO's (S and H types only)	
0	100%
D	80%
Y	100 V

PRESS-PACK IGBT CAPSULE DEVICES

T	0240	N	B	45	E	
						Device type
T						Press-pack IGBT
	0240					Device pulse current rating
						Electrode diameter
		Q				38mm
		N				47mm
		V				63mm
		H				66mm
		T				75mm
		E				85mm
		A				96mm
		D				110mm
		G				125mm
		B				132mm
			B			Die series
			D			
			F			
				45		Voltage grade - $V_{RRM}/100$
						Build description for multiple square die
					A	Reverse conducting
					E	Asymmetric
					G	Reverse Conductiing (IGBT to diode ratio of 2:1)

STUD DEVICES

W	0508	S	A	04	0	
						Device type
W						Rectifier diode
M						Fast/Soft recovery diode
N						Phase control thyristor
P						Fast turn-off thyristor
S						Symmetrical Gate turn-off thyristor
	0508					Device nominal current rating
						Device polarity
		S				Stud Anode
		R				Stud Cathode
						Package
			A			3/4" stud glass/metal
			C			3/4" stud ceramic
			E			3/4" HV ceramic stud with lug
			F			3/4" HV ceramic stud
						1/2" ceramic stud
			H			1/2" ceramic stud with flag
			J			M12 stud ceramic with lug
			L			
			M			3/8" stud ceramic
			R			M20 stud ceramic with lug & gate leads
				04		Voltage grade - $V_{RRM}, V_{DRM}/100$
					0	t_q code - See table for relevant code

All IXYS UK stud devices are available with or without leads, sleeving and nuts and washers

Please add one of the following three-letter codes, based on what options are required, to the end of the part number when ordering

- 000 - Leaded stud, no sleeving, no nuts and washers supplied
 - S0L - Leaded stud, with standard* sleeving, nuts and washers supplied loose
 - 00L - Leaded stud, no sleeving, nuts and washers supplied loose
 - NLL - Non-leaded stud, nuts and washers supplied loose (Applies also to devices with flag/tag terminal)
 - S0F - Leaded stud, with standard* sleeving, nuts and washers fitted
 - 00F - Leaded stud, no sleeving, nuts and washers fitted
 - NLF - Non-leaded stud, nuts and washers fitted (Applies also to devices with flag/tag terminal)
 - S00 - Leaded stud, with standard* sleeving, no nuts and washers supplied
 - NLS - Non-leaded stud, no nuts and washers fitted (Applies also to devices with flag/tag terminal)
- * - Standard sleeving means the following
 Red for all thyristor studs
 Blue for 'S' polarity diode studs
 Red for 'R' polarity diode studs

- Valid only for products from IXYS / Littelfuse Lampertheim
- Usage for new technologies, chips, packages and/or groups
- Newer data sheets contain description of part number

Index	0	1	2	3	Value 1	4	5	Value 2	6 (a-c)	6 d	7	8	9
Example 1	M	I	X	G	120	W		1200	DPF	T	E	H	- PC
Example 2		I	X	A	40	P	G	1200	DHG		L	B	- TUB
Example 3		C	M	A	20	E		1600			P	Z	- TRL

Index	
0	M = Module; no letter for discretes
1	Kind of main chip C = SCR, D = Diode, I = IGBT, M = MosFET
2	Chip technology
3	Chip generation resp. precisely defined technology
Value 1	Current rating
4	Basic circuit
5	Precisely defined circuit
Value 2	Voltage rating
6 (a-c)	as Index 1-3; usage e.g. for special chips like SiC
6 d	Specials (e.g.: thermistor)
7	Basic package
8	Precisely defined package
Hyphen	-
9	Extras: e.g. delivery formats, auxiliaries

Examples for Indices

Index 1 & 2	Description	detailed
CL	High Efficiency Thyristor	up to 1200V
CM	Thyristor	up to 1800V
CN	High Voltage Thyristor	≥ 2000V
DF	FRED	Gold
DH	Sonic Fast Recovery Diode	Helium
DL	Low Voltage Standard Rectifier	up to 1200V
DM	Standard Rectifier	up to 1800V
DN	High Voltage Standard Rectifier	≥ 2000V
DP	HiPerFRED™	Platinum
DS	Schottky Diode	2nd generation
IG	IGBT	PT (Punch Through)
IT	IGBT	Trench
IX	IGBT	XPT
MK	Superjunction MOSFET	Powered by Infineon CoolMOS™ bare die
MT	MOSFET	Trench

Examples for Indices

Index 4	Description	detailed	Index 4 & 5
A	Common anode/ emitter/ source	, Thyristor/Diode	AD
B	1~ Rectifier Bridge	, half-controlled (high side)	BH
C	Common cathode/ collector/ drain	, Thyristor/Diode	CD
E	Single Part	+ multiple cathode pins	EM
H	H~ Bridge	+ 1~ Rectifier Bridge	HD
I	Single Part	, Copack	IF
M	AC-Controlling	/ Triac	MT
P	Phase leg	, high-side Thyristor / low-side Diode	PD
Q	Buck Chopper	with series connected dice	QS
R	Boost/Brake Chopper	+ free wheeling diode + Vcesat-Diode	RG
S	Brake Chopper (Rating IGBT >> Rating Diode)	+ free wheeling diode	SF
U	3~ Rectifier Bridge	+ Brake unit	UB
W	6-Pack	+ 3~ Rectifier Bridge & Brake Unit	WB
X	Parallel legs	, anti-parallel	XA
Y	Half 3~ Bridge	, Common anode	YA

Index 7 & 8 Discretes	Description	Index 7 & 8 Discretes	Description
FA	i4-Pac (3sym)	NB	SOT-227UI (minibloc)
FB	i4-Pac (3HV)	PA	TO-220AC (2)
FC	i4-Pac (5)	PB	TO-220AB (3)
FD	i4-Pac (5HC)	PC	TO-263AB (D2Pak) (2)
FE	i4-Pac (2HV)	PJ	ISOPLUS220AB (3)
HA	TO-247AD (2)	PM	TO-220ACFP (2)
HB	TO-247AD (3)	PN	TO-220ABFP (3)
HF	PLUS247 (3)	PZ	TO-263AB (D2Pak) (2HV)
HI	ISOPLUS247 (2)	QB	TO-3P (3)
HJ	ISOPLUS247 (3)	TC	TO-268AA (D3Pak) (2)
HR	ISO247 (3)	TZ	TO-268AA (D3Pak) (2HV)
IB	TO-262 (I2Pak) (3)	UC	TO-252AA (DPak)
LB	SMPD-B	UZ	TO-252AA (DPak) (2HV)
NA	SOT-227B (minibloc)		

Index 7 & 8 Modules	Description	Index 7 & 8 Modules	Description
CA	ComPack	TA	TO-240AA-1B
CB	ComPack	TB	TO-240AA-1B
CC	ComPack	TG	TO-240AA-1B
ED	E2-Pack	VA	V1-A-Pack
EH	E3-Pack	VC	V1-B-Pack
KA	Y1-CU	VH	V2-Pack
KB	Y1-CU	YA	Y4-M6
KC	Y1-CU	YB	Y4-M6
SF	Simbus F	YD	Y4-M6

Index 6 d	Specials	Index 9	Packaging
P	PressFit-Pin	NI	No Metal Inserts
PT	PressFit-Pin + Thermistor	PC	Phase Change Material
PST	PressFit-Pin + Shunt + Thermistor	TRL	Tape & Reel Left
S	Shunt	TRR	Tape & Reel Right
T	Thermistor	TUB	Tube

Pressfit Pin PACKAGES

Pressfit Pin for E2, E3 and SimBus F Module Packages

IXYS presents a new Press-Fit-Pin for E2 and E3 module packages. Modules equipped with those pins can be connected to the PCB without a further solder process. For the pressing process either hand tools or pressing machines can be used. Benefits for the assembly are:

- simplified process
- reduced mounting time
- no risk of bad solder contacts
- reduced aging of pin contact
- no thermal stress for the PCB assembly
- press out possible for maintenance

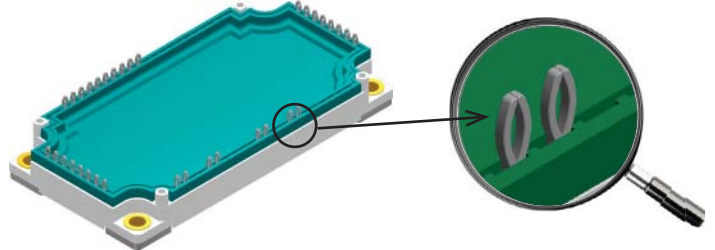

The pin concept is based on the proven „Bizon“-Pin concept. Pressing process is a plastic deformation of pin and via of the board ending in a cold welding. Pin features are:

- Pin concept based on successfully proven „Bizon“-Pin concept
- Pin qualification according to IEC 60352-5
- High conductive Cu alloy with Ni / gal. Tin surface
- Very low contact resistance
- Low press-in force per pin and PCB hole diameter independent press-out force
- Press-Fit-Pin usable for PCB's designed for competitor devices

Started with the following modules types:

Pin configuration see Data Sheets

Board and Via Requirements E2 and E3			
	min.	typical	max.
Drill hole diameter		2.35 mm	
Final hole diameter	2.14 mm	2.20 mm	2.29 mm
Cu thickness inside the hole	>25 µm		
Sn thickness inside the hole			<15 µm
Cu thickness for PCB tracks	35 µm	70 µm 105 µm	
PCB thickness	1.60 mm	2.00 mm	
Metallization PCB	chem. Tin		
Board and Via Requirements SimBus F			
	min.	typical	max.
Drill hole diameter		1.16 mm	
Final hole diameter	1.00 mm	1.05 mm	1.10 mm
Cu thickness inside the hole	>25 µm		
Sn thickness inside the hole			<15 µm
Cu thickness for PCB tracks	35 µm	70 µm 105 µm	
PCB thickness	1.60 mm	2.00 mm	
Metallization PCB	chem. Tin		

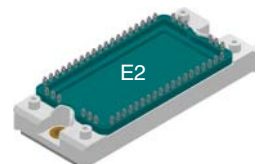

MCMA 240U1600PED
MDMA 210UB1600PTED
MDMA 280UB1600PTED
MDMA 360UB1600PTED

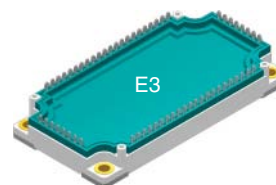

MIXG 120W1200PTEH
MIXG 180W1200PTEH
MIXG 240W1200PTEH
MDMA 450U1600PTEH
MDMA 660U1600PTEH
MDMA 900U1600PTEH
MDNA 660U2200PTEH
MUBW 50-17T8-PFPC
MUBW 75-17T8-PFPC

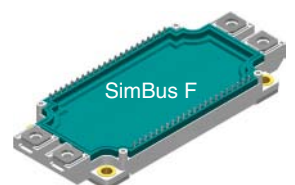

MDMA 600P1600PTSF
MDNA 600P2200PTSF
MCNA 360PD2200PTSF
MCMA 400PD1600PTSF
MCNA 500PD2200PTSF
MCMA 550PD1600PTSF
MCNA 360P2200PTSF
MCMA 400P1600PTSF
MCNA 500P2200PTSF
MCMA 550P1600PTSF

High Voltage TO-252 (D-Pak) package

- ✓ improved pin spacing (no middle pin)
- ✓ creepage distance pins to copper of backside: 2.5 mm for new packages

Type	Technology	Config.	V _{RRM}	I _{FAV} / I _D	@ T _C	Package style	
➤ New			V	A	°C	Outline drawings on pages O-36...O-59	
Diode						X004a TO-252AA 	
DMA 10IM1200UZ DMA 10IM1600UZ	Standard diode	Single	1200 1600	10	150		
DMA 10P1200UZ DMA 10P1600UZ		Phase Leg	2x 1200 2x 1600	10	150		
Sonic Diode							Creepage (min): pin/pin: 3.6 mm pin/Cu back-side: 2.5 mm
➤ DHG 10IM1800UZ	Fast Recovery Diode	Single	1800	10	100		
MOSFET							
➤ IXTY 1R4N120PHV	Standard MOSFET	Single	1200	1.4	25		

High Voltage TO-263 (D²-Pak) package

- ✓ improved pin spacing (no middle pin)
- ✓ creepage distance pins to copper of backside: 4.7 mm for new TO-263ABHV package

Type	Technology	Config.	V _{RRM}	I _{FAV} / I _D	@ T _C	Package style	
➤ New			V	A	°C	Outline drawings on pages O-36...O-59	
Diode						X011c TO-263ABHV 	
DMA 10IM1600PZ	Standard diode	Single	1600	10	150		
DMA 30IM1600PZ			1600	30	140		
DNA 30E2200PZ DNA 30EM2200PZ			2200 2200	30 30	140 140		
DMA 10P1600PZ DMA 10P1800PZ		Phase Leg	2x 1600 2x 1800	10 10	150 150		
DAA 10EM1800PZ DAA 10P1800PZ			Avalanche diode	Single	1800		10
		Phase Leg		2x 1800	10		150
FRED / HiPerFRED							
DSEI 12-12AZ	FRED	Single	1200	11	100		
DSEP 12-12AZ	HiPerFRED			12	135		
DSEP 12-12BZ				15	130		
SiC Diodes							
➤ LSIC2SD065D06A	Schottky Barrier Diode	Single	650	6	152		
➤ LSIC2SD065D08A				8	150		
➤ LSIC2SD065D10A				10	147		
➤ LSIC2SD065D16A				16	140		
➤ LSIC2SD065D20A				20	135		
LSIC2SD120D10				1200	10	151	
LSIC2SD120D15					15	150	
LSIC2SD120D20					20	150	

High Voltage TO-263 (D²-Pak) package

- ✓ improved pin spacing (no middle pin)
- ✓ creepage distance pins to copper of backside: 4.7 mm for new TO-263ABHV package

Type	Technology	Config.	V _{RRM}	I _{FAV} /I _D	@ T _C	Package style
¹⁾ two gate polarities for trigger ²⁾ Anode gated			V	A	°C	Outline drawings on pages O-36...O-59
Thyristor						
CLA 5E1200PZ	High Efficiency SCR	Single	1200	5	135	
¹⁾ CLA 15E1200NPZ				15	120	
¹⁾ CLA 30E1200NPZ				30	115	
²⁾ CLB 30I1200PZ				30	115	
¹⁾ CLA 40E1200NPZ				40	125	
²⁾ CLB 40I1200PZ				40	125	
CMA 20E1600PZ	Standard Thyristor	Single	1600	20	115	
CMA 30E1600PZ				30	115	
CME 30E1600PZ	Fast Thyristor	Single	1600	30	80	
Triac						
CLA 30MT1200NPZ	High Efficiency	Triac	1200	15	120	
CLA 40MT1200NPZ				20	115	
Triode (Reverse Conducting Thyristor)						
CLA 20EF1200PZ	High Efficiency	Single	1200	20	115	

Type	Technology	Config.	V _{CES}	I _{C25}	V _{CEsat} typ.
◇ under development ➤ New			V	A	V
IGBT & BiMOS					
◇ IXA 4IF1200PZ	XPT™ IGBT	Copack	1200	9	1.8
IXA 20I1200PZ		Single		38	1.8
IXYA 20N120C3HV	Fast XPT™ IGBT	Single	1200	40	3.4
IXYA 20N120A4HV	GenX4™ XPT™ IGBT	Single	1200	80	1.7
➤ IXYA 20N120B4HV				76	1.8
➤ IXYA 20N120C4HV				68	2.1
IXYA 30N120A4HV				106	1.6
IXYA 8N250CHV	High Voltage XPT™ IGBT	Single	2500	29	3.4
IXYA 12N250CHV				28	3.7
IXGA 20N250HV	High Voltage NPT IGBT	Single	2500	30	3.1
IXBA 16N170AHV	High Voltage BiMOS	Single	1700	16	6.0
IXBA 10N300HV				3000	34
IXBA 14N300HV			38	2.7	

X011c **TO-263ABHV**



Creepage (min):
pin/pin: 4.2 mm
pin/Cu back-side: 4.7 mm
For more details see outline drawings

Type	Technology	Config.	V _{DSS}	I _{D25}	R _{DSon} max. W
			V	A	W
MOSFET					
IXFA 8N85XHV	X-Class HiPerFET™	Single	850	8	0.85
IXFA 14N85XHV				14	0.55
IXFA 20N85XHV				20	0.33
IXTA 08N100D2HV	Depletion Mode MOSFET	Single	1000	0.8	21.0
IXTA 3N100D2HV				3.0	6.0
IXTA 05N100HV	High Voltage MOSFET	Single	1000	0.75	17.0
IXTA 3N120HV		Single	1200	3.0	4.5
IXTA 3N150HV		Single	1500	2.0	7.3
IXTA 4N150HV				4.0	6.0
IXTA 1N200P3HV		Single	2000	1.0	40.0
IXTA 02N250HV		Single	2500	0.2	450

High Voltage TO-268 (D³-Pak) package

- ✓ improved pin spacing (no middle pin)
- ✓ creepage distance pins to copper of backside: 5.8 mm for new packages

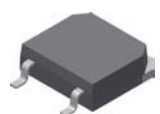
Type	Technology	Config.	V _{CES} / V _{DSS}	I _{C25} / I _{D25}	V _{CEsat} typ.	R _{DSon} max.	Package style Outline drawings on pages O-36...O-59		
➤ New			V	A	V	(m)Ω			
IGBT									
IXYT 30N65C3H1HV	GenX3™ XPT™ IGBT	Single	650	60	2.7	-	X019a TO-268AAHV  Creepage (min): pin/pin: 9.4 mm pin/Cu back-side: 5.8 mm For more details see outline drawings		
IXYT 20N120C3D1HV			1200	36	3.4	-			
➤ IXYT 40N120A4HV	GenX4™ XPT™ IGBT	Single	1200	150	1.8	-			
➤ IXYT 55N120A4HV				175	1.5	-			
➤ IXYT 85N120A4HV				300	1.5	-			
IXYT 12N250CV1HV	High Voltage XPT™ IGBT	Single	2500	28	3.7	-			
IXYT 25N250CHV				95	4.0	-			
IXYT 30N450HV				4500	60	3.9		-	
IXGT 25N250HV	High Voltage NPT IGBT	Single	2500	60	2.9	-			
IXBT 16N170AHV	High Voltage BIMOS	Single	1700	16	6.0	-			
IXBT 22N300HV				3000	60	2.7		-	
IXBT 32N300HV				80	2.8	-			
IXBT 42N300HV				104	3.0	-			
IXBT 16N360HV				3600	48	2.5		-	
IXBT 20N360HV					70	3.4		-	
MOSFET									
IXTT 140N075L2HV	Linear MOSFET	Single	75	140	-	(11)			
➤ IXTT 44N25L2HV			250	44	-	(75)			
IXTT 440N04T4HV	TrenchT4™ MOSFET	Single	40	440	-	(1.25)			
➤ IXFT 26N100XHV	X-class HiPerFET™	Single	1000	26	-	(320)			
➤ IXFT 32N100XHV				32	-	(220)			
IXTT 34N65X2HV	X2-class MOSFET	Single	650	34	-	(96)			
IXFT 60N65X2HV	X2-class HiPerFET™	Single	650	60	-	(52)			
IXFT 80N65X2HV				80	-	(38)			
IXFT 30N85XHV				850	30	-	(230)		
IXFT 40N85XHV	X3-class HiPerFET™	Single	200	40	-	(145)			
IXFT 50N85XHV				50	-	(105)			
IXFT 140N20X3HV				140	-	(96)			
IXFT 180N20X3HV					180	-	(75)		
IXFT 220N20X3HV					220	-	(62)		
IXFT 120N25X3HV				250	120	-	(120)		
IXFT 150N25X3HV	150	-	(90)						
IXFT 170N25X3HV	170	-	(74)						
IXFT 100N30X3HV	300	100	-	(135)					
IXFT 120N30X3HV		120	-	(110)					
IXFT 150N30X3HV		150	-	(83)					
➤ IXTT 240N15X4HV	X4-class MOSFET	Single	150	240	-	(4.4)			
IXTT 4N150HV	High Voltage MOSFET	Single	1500	4	-	6			
IXTT 12N150HV				12	-	2			
IXTT 3N200P3HV				2000	3	-	8		
IXTT 1N250HV				2500	1.5	-	40		
IXTT 1N300P3HV				3000	1	-	50		
IXTT 2N300P3HV				2	-	21			
IXTT 02N450HV				4500	0.2	-	625		
IXTT 1N450HV					1	-	80		
➤ MCB 60I1200TZ				SiC Power MOSFET	Single	1200	90	-	(34)

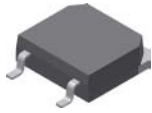

High Voltage TO-268 (D³-Pak) package

- ✓ improved pin spacing (no middle pin)
- ✓ creepage distance pins to copper of backside: 5.8 mm for new packages

Type	Technology	Config.	V _{RRM}	I _{DAV} / I _{TAV}	@ T _C	Package style
➤ New			V	A	°C	Outline drawings on pages O-36...O-59
Rectifier						
➤ DSEI 120-12AZ	FRED	Single	1200	109	60	X019a TO-268AAHV  Creepage (min): pin/pin: 9.4 mm pin/Cu back-side: 5.8 mm For more details see outline drawings
DSEP 60-12AZ	HiPerFRED	Single	1200	60	115	
DSEP 90-12AZ	HiPerFRED	Single	1200	90	105	
DSP 45-12AZ	Standard diode	Phase leg	2x 1200	45	130	
DSP 45-16AZ			2x 1600	45	130	
➤ DLA 100IM1200TZ			1200	100	105	
CLA 60MT1200NTZ	High Efficiency	Triac	1200	30	120	
CMA 50E1600TZ	Standard Thyristor	Single	1600	50	110	
➤ CLA 100E1200TZ			1200	100	105	
CNE 60E2200TZ	High Voltage Thyristor		2200	60	80	



High Voltage TO-247HV and PLUS247HV packages

- ✓ improved pin spacing for high potential
- ✓ creepage distance pins to copper of backside: > 5.7 mm
- ✓ creepage distance between high voltage pins (collector/emitter or drain/source): > 7.0 mm

Type	Technology	V _{CES} / V _{DSS}	I _{C25} / I _{D25}	V _{CEsat}	w / Diode	R _{DS(on)} max.	Fig. No.	Package style	
		V	(I _{C110}) A	typ. V		Ω		Outline drawings on pages O-36...O-59	
IXYH 8N250CHV	XPT™ IGBT	2500	(8)	4.0		-	X014c	X014c TO-247HV 	
IXYH 8N250CV1HV			(8)	4.0	•	-			
IXYH 12N250CHV			(12)	4.5		-			
IXYH 12N250CV1HV			(12)	4.5	•	-			
IXYH 16N250CV1HV			(16)	4.0	•	-			
IXYH 25N250CHV			(25)	4.0		-			
IXYX 25N250CV1HV			(25)	4.0	•	-			X015c
IXYX 40N250CHV			(40)	4.0		-			
IXYH 30N450HV		4500	(30)	3.9		-	X014c		
IXYX 40N450HV			35	3.9		-	X015c		
IXBH 10N300HV	BiMOSFET	3000	34	2.8		-	X014c		
IXBH 14N300HV			38	2.7		-			
IXBH 22N300HV			60	2.7		-			
IXBX 28N300HV			62	2.7		-		X015c	
IXBH 32N300HV			(32)	2.8		-		X014c	
IXBH 42N300HV			(42)	2.5		-			
IXBH 16N360HV		3600	48	2.5		-	X014c		
IXBH 20N360HV			70	3.4		-			
IXBX 50N360HV			125	2.9		-		X015c	
IXTH 02N450HV	MOSFET	4500	0.2	-		625	X014c		
IXTH 1N450HV			1.0	-		80			
IXTX 1R4N450HV			1.4	-		40		X015c	
								X015c PLUS247HV 	

High Voltage TO-247HV and PLUS247HV packages

- ✓ improved pin spacing for high potential
- ✓ creepage distance pins to copper of backside: > 5.7 mm
- ✓ creepage distance between high voltage pins (collector/emitter or drain/source): > 7.0 mm

Type	Technology	V_{CES} / V_{DSS} V	I_{C25} / I_{D25} (I_{C110}) A	V_{CESat} typ. V	w / Diode	$R_{DS(on)}$ max. Ω	Fig. No.	Package style Outline drawings on pages O-36...O-59	
IXTH 1N200P3HV IXTH 3N200P3HV IXTX 6N200P3HV	Polar 3 MOSFET	2000	1.0	-		40	X014c	X014c TO-247HV 	
			3	-		8	X015c		
			6	-		4	X014c		
IXTH 06N220P3HV IXTH 1R8N220P3HV			2200	0.6	-		80	X014c	X015c PLUS247HV 
				1.8	-		21.5	X014c	
IXTH 05N250P3HV			2500	0.5	-		110	X014c	
IXTH 04N300P3HV IXTH 1N300P3HV IXTH 2N300P3HV IXTX 4N300P3HV		3000	0.4	-		190	X014c		
			1.0	-		50	X015c		
			2	-		21	X015c		
			4	-		12.5	X015c		

ISO247 package

- ✓ 3000V isolation
- ✓ Excellent thermal performance
- ✓ 100% mechanical fit to TO-247

Type	Technology	Configuration	V_{RRM} V	I_{DAV} / I_{TAV} A	@ T_C $^{\circ}C$	Package style Outline drawings on pages O-36...O-59	
➤ New							
Diode							
DSA 90C200HR	Schottky Diode	Common Cathode	200	2x 45	145	X016c ISO247™ 	
DPF 30P600HR	HiPerFRED	Phase Leg	2x 600	30	130		
DMA 10P1200HR	Standard		2x 1200	10	145		
DMA 10P1600HR			2x 1600	10	145		
DMA 30P1600HR	2x 1600		30	105			
DMA 50P1200HR	2x 1200		50	105			
➤ DCG 10P1200HR	SiC Schottky Diode		Common Cathode	2x 1200	10		80
➤ DCG 17P1200HR		17		80			
➤ DCG 20C1200HR		2x 10		80			
➤ DCG 35C1200HR			2x 17	80			
Thyristor							
CLA 40E1200HR	High Efficiency	Single	1200	40	95		
CMA 40E1600HR	Standard		1600	40	90		
Triac							
CLA 40MT1200NHR	High Efficiency	Triac	1200	20	110		
CLA 60MT1200NHR				30	100		
CLA 80MT1200NHR				40	100		
CMA 60MT1600NHR	Standard		1600	30	90		
CMA 80MT1600NHR				40	95		

ISO247 package

- ✓ 3000V isolation
- ✓ Excellent thermal performance
- ✓ 100% mechanical fit to TO-247

Type	Technology	Config.	V_{CES} / V_{DSS}	I_{C25} / I_{D25}	V_{CESat}	R_{DSon}	Package style	
<ul style="list-style-type: none"> ➤ New ◇ under development 			V	A	typ. V	max. Ω	Outline drawings on pages O-36...O-59	
IGBT								
◇ IXA 20IF1200HR	XPT™ IGBT	Copack	1200	33	1.8	-	X016c ISO247™ 	
◇ IXA 30IF1200HR				48	1.8	-		
◇ IXA 40IF1200HR				63	1.8	-		
➤ ITF 48IF1200HR	Fast Trench IGBT	Copack	1200	72	2.4	-		
MOSFET								
IXFJ 26N50P3	Polar3™ HiperFET™	Single	500	14	-	0.265		
IXFJ 80N25X3	X3-Class HiPerFET™	Single	250	44	-	0.018		
IXFJ 20N85X				850	9.5	-		0.36
IXTJ 3N150	High Voltage MOSFET	Single	1500	2.3	-	8.00		
IXTJ 4N150				2.5	-	6.00		
IXTJ 6N150				3.0	-	3.85		

TO-247-4L package

- ✓ separate driver source pin for optimized gate control
- ✓ reduced gate loop
- ✓ optimized for fast switching SiC MOSFETs

Part Type	V_{DSS}	I_D $T_C = 25^\circ\text{C}$	I_D $T_C = 100^\circ\text{C}$	$R_{DS(on)}$ $T_J = 25^\circ\text{C}$	C_{iss} typ	Q_g typ	R_{thJC}	Package style
◇ Under Development	V	A	A	$m\Omega$ (typ)	pF	nC	K/W	Outline drawings on pages O-60...O-64
SiC MOSFETs								
◇ LSiC1MO120G0025	1200	100	70	25	4465	250	0.30	L014d TO-247-4L 
◇ LSiC1MO120G0040		65	50	40	2825	160	0.42	
◇ LSiC1MO120G0080		39	25	80	1825	95	0.70	
◇ LSiC1MO120G0120		27	18	120	1125	80	0.90	
◇ LSiC1MO120G0160		22	14	160	870	57	1.00	

ISOPLUS-SMPD™

ISOPLUS-DIL™

ISOPLUS i4-PAC™

ISOPLUS264™

ISO247™

ISOPLUS247™

ISOPLUS220™

Isolated Discrete Packages

ISOPLUS247™ is the DCB isolated version of the PLUS247™ package (TO-247 without a mounting hole). The design of this patented package is revolutionary: the silicon chip is soft soldered onto a Direct Copper Bond (DCB) substrate instead of the usual copper lead frame. The DCB ceramic, the same substrate material as used in the high power modules, not only provides high isolation capability (2500 V_{RMS}) but also unbeatable low thermal resistance compared to conventional, externally mounted isolation materials.

Advantages:

- Isolation capability from leads to back-side 2500 V_{RMS} – no external isolation foil needed
- Thermal resistance from Junction to Case only slightly higher as for non-isolated version
- Increased power- and temperature cycling capability
- DCB can be patterned like printed circuit boards – allowing special functions to be realized

types available.

Another interesting feature is the capability to pattern the DCB substrate like a printed circuit board. Now additional special functions can be realized, e.g. the **series connection of single** diode chips within one package.

ISOPLUS220™, ISOPLUS247™ and ISOPLUS264™ are the DCB substitutes for the corresponding standard packages.

A larger version of this packaging technology is named **ISOPLUS i4-PAC™**. It has up to five terminal pins, making it possible to build up full diode bridges, phase-leg transistor configurations, buck and boost converters and much more within one isolated discrete package.

Package cross section

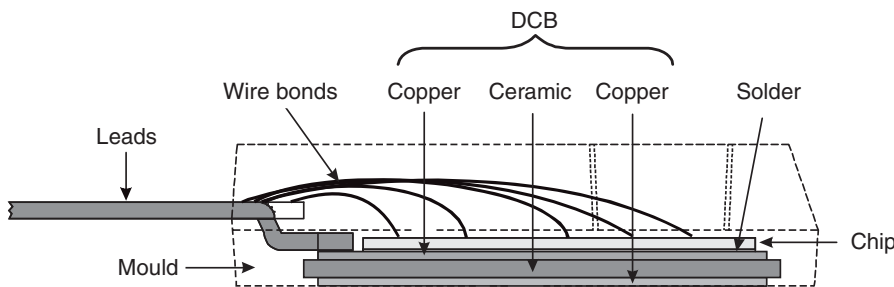

While the junction-to-case thermal resistance is higher than an equivalent, non-isolated device, what really matters is the total thermal resistance from junction-to-heatsink (R_{thJH}). Comparing a device in ISOPLUS247™ to its companion in the non-isolated package with an external isolation foil, one can see that the overall R_{th} is now lower for the part in the already isolated package (see example).

Due to the matched thermal expansion coefficients of silicon and DCB ceramic, mechanical stress to the die and solder caused by power and temperature

cycling is reduced so that reliability is improved. Mounting is done with clips, which not only saves time but also guarantees constant pressure force over the whole lifetime of the assembly.

Parts in the **ISOPLUS247™** housing can be identified by the letter “R” in the IXYS part number. Potentially all devices now encapsulated in TO-247, TO-264 and PLUS247™ housings can be molded in the ISOPLUS247™. There are already more than 100 different ISOPLUS247™

ISOPLUS-DIL™ 37.5 mm long and 25 mm wide provides the largest mounting area within the ISOPLUS™ family. It is available in 2 pin out version: „GWM“ configuration with 300 A RMS on one side and 12 control pins on the opposite side and the „GMM“ configuration with 12 pins on either side. The package is intended for high current low voltage (< 200 V) applications either as single switch or 6-pack. With highest power density and high reliability ISOPLUS-DIL™ is recommended for the use in automotive designs.

ISOPLUS-SMPD™ is the latest member of IXYS ISOPLUS™ family and provides an increased creepage distance between pins to DCB (>4 mm) and pin to pin (up to 7 mm).

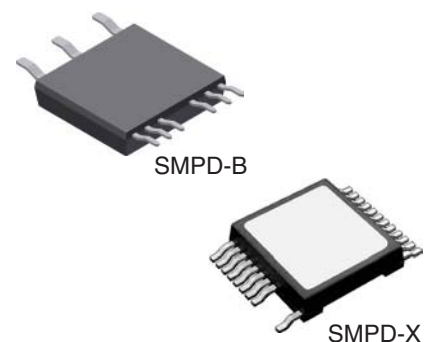

Example: ISOPLUS247™ compared to conventional isolated device

Type	Package	Isolation	R_{thJC} K/W	R_{thCK} K/W	Total K/W	Factor
IXFR 180N10	ISOPLUS247™	internal DCB	0.3	0.15	0.45	1
IXFX 180N10	PLUS247™	external foil	0.22	1.02	1.24	2.8

DCB isolated SMPD package for simplified mounting and high circuit flexibility

Reducing assembly costs is a continual demand of the semiconductor user. One of the various approaches is the usage of SMD packages which is successfully introduced by utilization of Power Semiconductors packaged in TO-263 (D²Pak) or TO-268 (D³Pak). If heat sinking is required designers have to look for solutions providing isolation and creepage distance.

ISOPLUS-SMPD™ package is the IXYS answer to the challenge to make designer's life easier as it provides an SMD device featuring:

- 2.5 kV isolation to heatsink (UL rating)
- low thermal impedance for good cooling by only 0.38 mm thick ceramic
- more than 4 mm creepage distance from pin to mounting surface
- up to 7 mm creepage from pin to pin (depending on package type)
- high integration such as phase leg or 3~ input rectifier in one package
- automatic mounting by pick & place possible (packaged in Tape & Reel)

This enables the engineer to make flat designs with a concept of distributed power dissipation. The latter allows utilization of heatsinks with a thinner base reducing weight and cost.

The new ISOPLUS-SMPD™ package is small and light weight with two rows of pins, resembling an IC. It allows the assembly to the board in standard SMD pick & place equipment, together with other standard SMD components. ISOPLUS-SMPD™ devices are available in Tape & Reel or in a Blister Tray option.

The complete board including the power components can run through a standard SMD soldering process.

Two types are available, ISOPLUS-SMPD™-B (Fig. 1) is optimized for implementing more complex configurations like phase-legs, buck and boost chopper as well as single – or 3-phase input rectifier bridges, which can ideally be used as building blocks for inverters. ISOPLUS-SMPD™-X (Fig. 2) with a larger number of pins on either side allows the integration of large dies for very high current capability up to 600 A per unit.

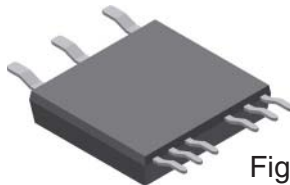

Fig. 1 SMPD-B

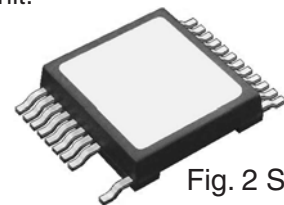

Fig. 2 SMPD-X

Both designs benefit from the ISOPLUS™ construction with low mechanical stress for the die because of a good match in the thermal expansion coefficient of die and DCB resulting in long term reliability.

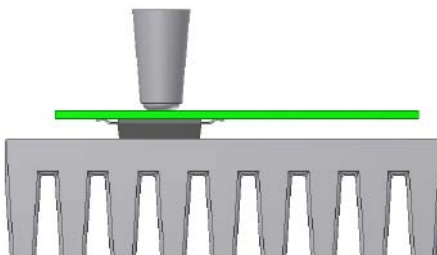

Fig. 3 Mounting example

As normal these devices require a layer of thermal interface material (heat transfer paste) to be applied to the backside of the power devices (or to the heat sink surface alternatively). Then the devices can be mounted together with the PCB to a heat sink.

These power devices need to be pressed down to the heat sink to ensure low thermal resistances. Pressure can be applied in different ways, for example using a mounting clip or a post, applying pressure via the PCB directly to the power device (see Fig. 3 and Fig. 4).

The high package flexibility allows to offer

- high current single Trench MOSFET
- high current single IGBT
- buck and boost converters
- phase-legs with desaturation diodes for switch control
- 1~ or 3~ input rectifiers
- multiple boost stages
- cascade configurations

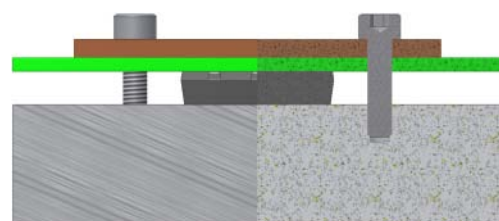
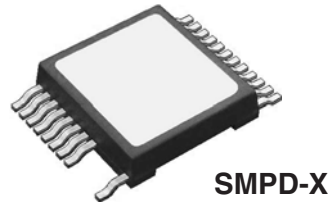
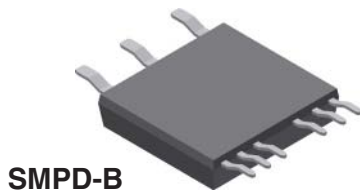

Fig. 4 Mounting example

Customer specific designs are feasible.

IGBT Modules – SMPD Converter Building Blocks

ISOPLUS™ Technology



- 2500 V UL rated electrical isolation
- low thermal resistance
- increased power & temperature cycling
- saves space

- replaces multiple discretes
- reduces parasitic inductance & capacitance
- reduces EMI
- heat spreading

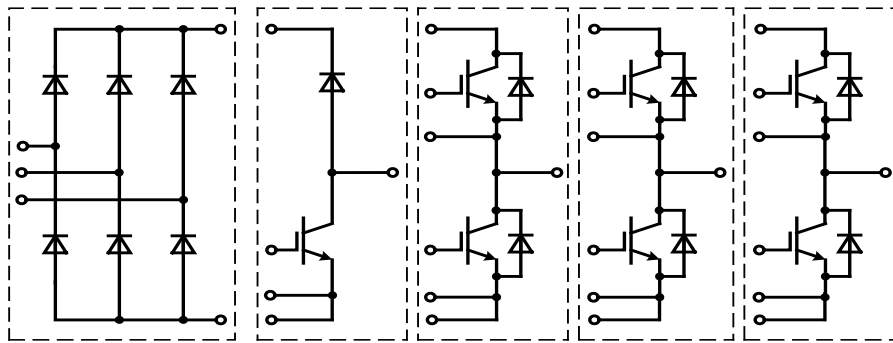

Rectifier

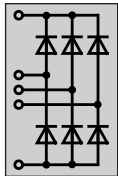

Line Rectifier

DMA 90U1800LB

Sonic-FRD

DHG 60U1200LB

Brake & Boost

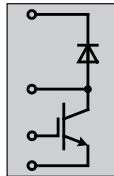

XPT-IGBT

IXA 20RG1200DHGLB

IXA 30RG1200DHGLB

IXA 40RG1200DHGLB

Inverter

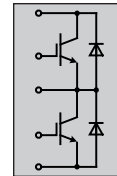

XPT-IGBT

IXA 20PG1200DHGLB

IXA 30PG1200DHGLB

IXA 40PG1200DHGLB

ITF 40PF1200DHGTLB

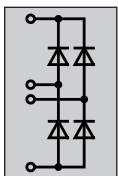

Line Rectifier

DLA 100B1200LB

DLA 100B800LB

Fast Rectifier

DPG 60B600LB HiPerFRED

DCG 20B650LB SiC

DHG 40B1200LB Sonic

DCG 20B1200LB SiC

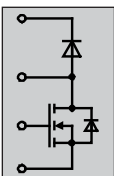

CoolMOS™ Boost

MKE 38RK600DFELB & FRED Diode

MKG 40RK600LB & Sonic Diode

MKH 17RP650DCGLB Dual Boost & SiC

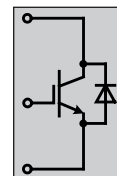

XPT-IGBT

MMIX 1X100N60B3H1

MMIX 1X200N60B3H1

MMIX 1Y82N120C3H1

MMIX 1Y100N120C3H1

IXG 70IF1200LB

MOSFETs

Type	Circuit diagram / Technology	V _{DS}	I _{D25}	R _{DS(on)} max.	Q _G	Fig. No.	Circuit Diagram
◇ under development		V	A	mΩ	nC		
➤ New							
SINGLE							
MMIX 1T600N04T2	A Trench2	40	600	1.3	590	X031a	
MMIX 1T550N055T2	A Trench2	55	550	1.3	595		
MMIX 1F520N075T2	A Trench2 HiPerFET™	75	500	1.6	545		
MMIX 1F420N10T	A Trench HiPerFET™	100	334	2.6	670		
MMIX 1F360N15T2	A Trench2 HiPerFET™	150	235	4.4	715		
MMIX 1F230N20T	A Trench HiPerFET™	200	156	8.3	358		
MMIX 1F180N25T	A Trench HiPerFET™	250	132	13	364		
MMIX 1F160N30T	A Trench HiPerFET™	300	102	20	376		
MMIX 1F210N30P3	A Polar3 HiPerFET™		108	16	268		
MMIX 1F132N50P3	A Polar3 HiPerFET™	500	63	43	267		
MMIX 1F44N100Q3	A Q3 HiPerFET™	1000	30	245	264		
MMIX 1F40N110P	A Polar HiPerFET™	1100	24	290	310		
BUCK / BOOST							
MKE 38RK600DFELB	C MOSFET ^① CP & FRED	600	50	45	150	X030a	
➤ MXB 40RK600DFELB	C X2 Class & FRED		68	38	140		
◇ MKH 17RP650DCGLB	D Dual MOSFET ^① CFD & SiC	650	2x 22	110	118		
PHASE-LEG							
MMIX 2F150N20T	B Trench™ HiPerFET™	200	84	16.5	177	X031a	
MMIX 2F94N30T	B Trench™ HiPerFET™	300	52	40	190		
MMIX 2F60N50P3	B Trench™ HiPerFET™	500	30	110	96		
MKE 38P600LB	B MOSFET ^① CP	600	50	40	150	X030a	
➤ MXB 40P650LB	B X2 Class	650	68	38	140		
➤ MCB 20P1200LB	B SiC	1200	22	98 (80 typ.)	62		
➤ MCB 30P1200LB	B SiC		37	52 (40 typ.)	115		
➤ MCB 40P1200LB	B SiC		58	34 (25 typ.)	161		
◇ MCB 60P1200TLB	F SiC & NTC		77	34 (25 typ.)	161		
◇ MCB 35P1700TLB	F SiC & NTC	1700	35	70 (45 typ.)	188		
SINGLE with Current and Temperature Sense							
MMIX 1T132N50P3	E Polar3™	500	63	43	267	X031a	

① Powered by Infineon CoolMOS™ superjunction bare die

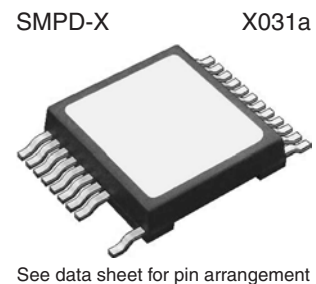
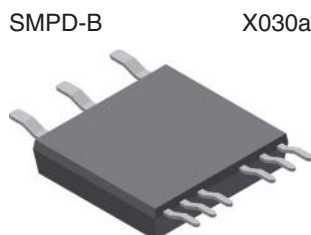

Outline drawings on pages O-36...O-59

IGBTs

Type	Circuit Diagram No. / Technology	V _{CES}	I _{C25}	V _{CE(sat)} typ.	E _{off} typ.	Fig. No.	Circuit Diagram
▶ New ✦ under development		V	T _C = 25°C A	T _C = 25°C V	T _J = 150°C (125°C) mJ		
SINGLE and COPACK							
MMIX 1X200N60B3	A XPT	600	223	1.40	3.45	X031a	
MMIX 1X100N60B3H1	B XPT & Sonic		145	1.50	2.80		
MMIX 1X200N60B3H1	B XPT & Sonic		175	1.40	3.45		
MMIX 1X340N65B4	A XPT™ IGBT GenX4™		450	1.40	2.54	X031a	
MMIX 1Y82N120C3H1	B XPT fast & Sonic	1200	78	2.90	(3.70)		
MMIX 1Y100N120C3H1	B XPT fast & Sonic		92	2.90	3.55		
✦ ITG 100IF1200LB	B Trench & Sonic2		150	1.65	9.2	X030a	
MMIX 1G120N120A3V1	B GenX3 IGBT & Sonic		110	1.85	58	X031a	
MMIX 1G75N250	A IGBT for cap discharge	2500	110	2.50	-		
▶ MMIX 1B15N300C	B BiMOSFET™	3000	37	4.70	-		
▶ MMIX 1B20N300C	B BiMOSFET™		50	4.50	-		
DUAL							
✦ ITG 100X1200LB	2x A 2 x Trench	1200	2x 85	1.65	4.5	X030a	
✦ ITG 100XF1200LB	2x B 2 x Trench & Sonic2		2x 85	1.65	4.5		
BOOST							
IXA 20RG1200DHGLB	E XPT & Sonic	1200	32	1.80	1.7	X030a	
IXA 30RG1200DHGLB	E XPT & Sonic		43	1.90	3.0		
IXA 40RG1200DHGLB	E XPT & Sonic		63	1.85	4.1		
PHASE-LEG							
IXA 20PG1200DHGLB	C XPT & Sonic	1200	32	1.80	1.7	X030a	
IXA 30PG1200DHGLB	C XPT & Sonic		43	1.90	3.0		
IXA 40PG1200DHGLB	C XPT & Sonic		63	1.85	4.1		
▶ ITF 40PF1200DHGTLB	D Trench IGBT & Sonic & NTC		56	2.05	2.6		
✦ ITF 40PG1200DHGLB	C Trench IGBT & Sonic		56	2.05	2.6		
FULL-BRIDGE							
MMIX 4G20N250	F IGBT for cap discharge	2500	23	3.1 max	-	X031b	

SMPD-Y

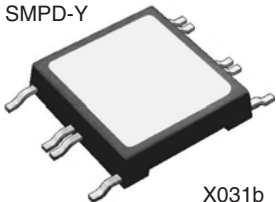

X031b

Outline drawings on
pages O-36...O-59

SMPD-B

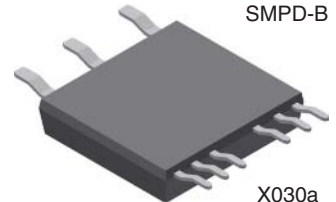

X030a

SMPD-X

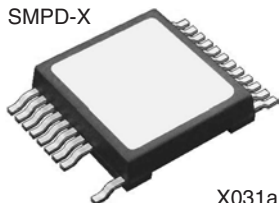

X031a

SMPD-Y

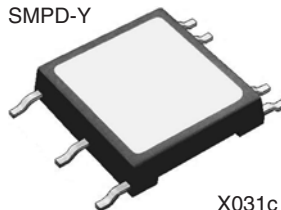

X031c

Diodes

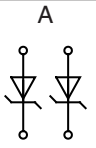
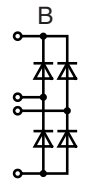
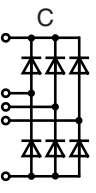
Type ➤ New ◇ under development	Circuit diagram / Diode type	V_{RRM} V	$I_{D(AV)M}$ A	@ T_C °C	Fig. No.	Circuit Diagram
DUAL						
DSA 120X150LB	A Schottky	150	2x 60	150	X030a	
DSA 120X200LB	A Schottky	200	2x 60	150		
◇ DSA 240X200LB	A Schottky		2x 120			
◇ DCG 40X1200LB	A SiC	1200	2x 14.5	80		
1~ BRIDGE						
DPG 60B600LB	B HiPerFRED	600	60	110	X030a	
➤ DCG 20B650LB	B SiC	650	21	80		
DLA 100B800LB ¹⁾	B Rectifier	800	124	80		
➤ DMA 120B800LB	B Rectifier		130	90		
DLA 100B1200LB	B Rectifier	1200	124	80		
➤ DHG 40B1200LB	B Sonic		34	80		
◇ DCG 20B1200LB	B SiC		18	80		
3~ BRIDGE						
DHG 60U1200LB	C Sonic	1200	62	80	X030a	
DMA 90U1800LB	C Rectifier	1800	99	80		

¹⁾ AECQ qualified

Thyristors, Triacs

Type ◇ under development	Circuit diagram / Bipolar type	V_{RRM} V	I_{TAV} A	@ T_C °C	Fig. No.
DUAL					
◇ CLA 60MU1200LB	2x D Triac	1200	2x 30	100	X030a
PHASE-LEG					
◇ CMA 50P1600LB	E Thyristor	2x 1600	50	90	X030a

MOS-Gated Thyristors

Type	V_{DM} V	I_{TSM} 1μs $T_C = 25°C$ kA	I_{TSM} 10μs $T_C = 25°C$ kA	r_T typ. mΩ	V_T max. V	$Q_{g(on)}$ typ. nC	t_{ri} typ. $T_C = 25°C$ ns	$V_{GK(th)}$ max. V	Circuit Diagram	Fig. No.
MMJX 1H40N150	1500	15.5	6.4	1.2	6	99	100	5	F	X032
MMIX 1H60N150V1	1500	32.0	11.8	1.2	6	180	100	5	G	X031a

Outline drawings on pages O-36...O-59

SMPD-B X030a

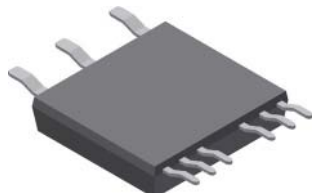

SMPD-X X031a

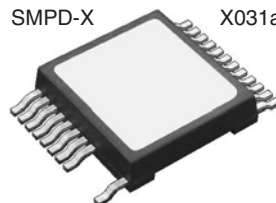

See data sheet for pin arrangement

MiniSMPD X032

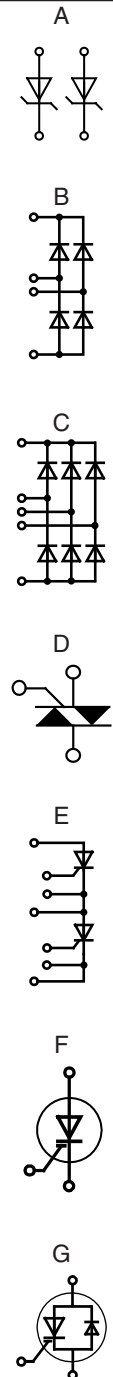

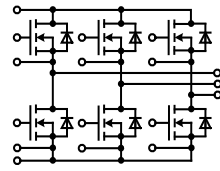

MTI..W..GC

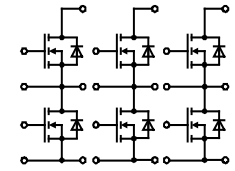

MTI...WX...GD / GMM

Six-Pack Trench MOSFET

Type	V_{DS}	I_{D25}	I_{D90}	$R_{DS(on)}$ typ.	C_{iss}	Q_g	R_{thJC}	Fig. No.
◇ under development	max.	$T_C = 25^\circ C$	$T_C = 90^\circ C$	$T_C = 25^\circ C$	typ	typ		
➤ New	V	A	A	mΩ	nF	nC	K/W	
Six-Pack								
➤ MTC 120W55GC	55	160	120	2.2	7.0	110	1.00	X026c
MTI 85W100GC	100	110	83	3.2	6.3	90	1.45	
3x Phase Leg								
➤ MTC 120WX55GD	55	160	120	2.2	7.0	110	1.00	X026d
◇ MTC 120WX75GD	75	160	120	2.2	10.5	178	0.80	
MTI 200WX75GD		265	200	1.1	10.8	155	0.85	
◇ MTI 85WX100GD	100	110	83	3.2	6.3	90	1.45	
MTI 145WX100GD		190	145	1.7	11.0	155	0.85	
GMM 3x60-015X2	150	50	38	19.0	5.8	97	1.00	

Customized configurations possible

Outline drawings on pages O-36...O-59

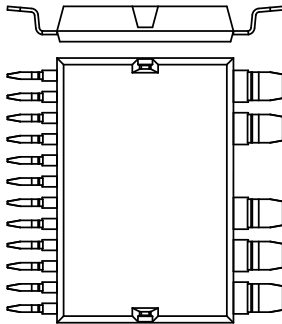

MTI..W..GC
SURFACE MOUNT DEVICE

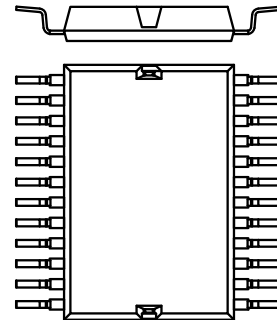

MTI...WX...GD; MTC...X...TGD; GMM...
SURFACE MOUNT DEVICE

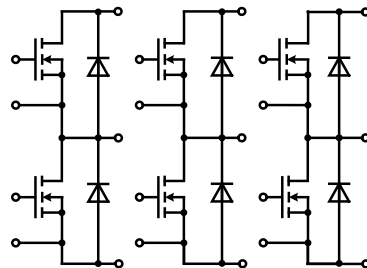
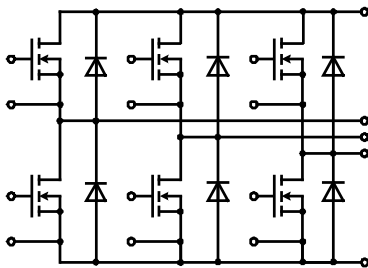

X026c ISOPLUS-DIL™



X026d ISOPLUS-DIL™

ISOPLUS™ i4-PAC™

3, 4 and 5 leaded packages for various circuit topologies

DCB base plate - 2500 V electrical isolation

- low thermal resistance
- increased power & temperature cycling
- saves space
- replaces multiple discretes
- reduces parasitic inductance and capacitance
- reduces EMI
- less weight

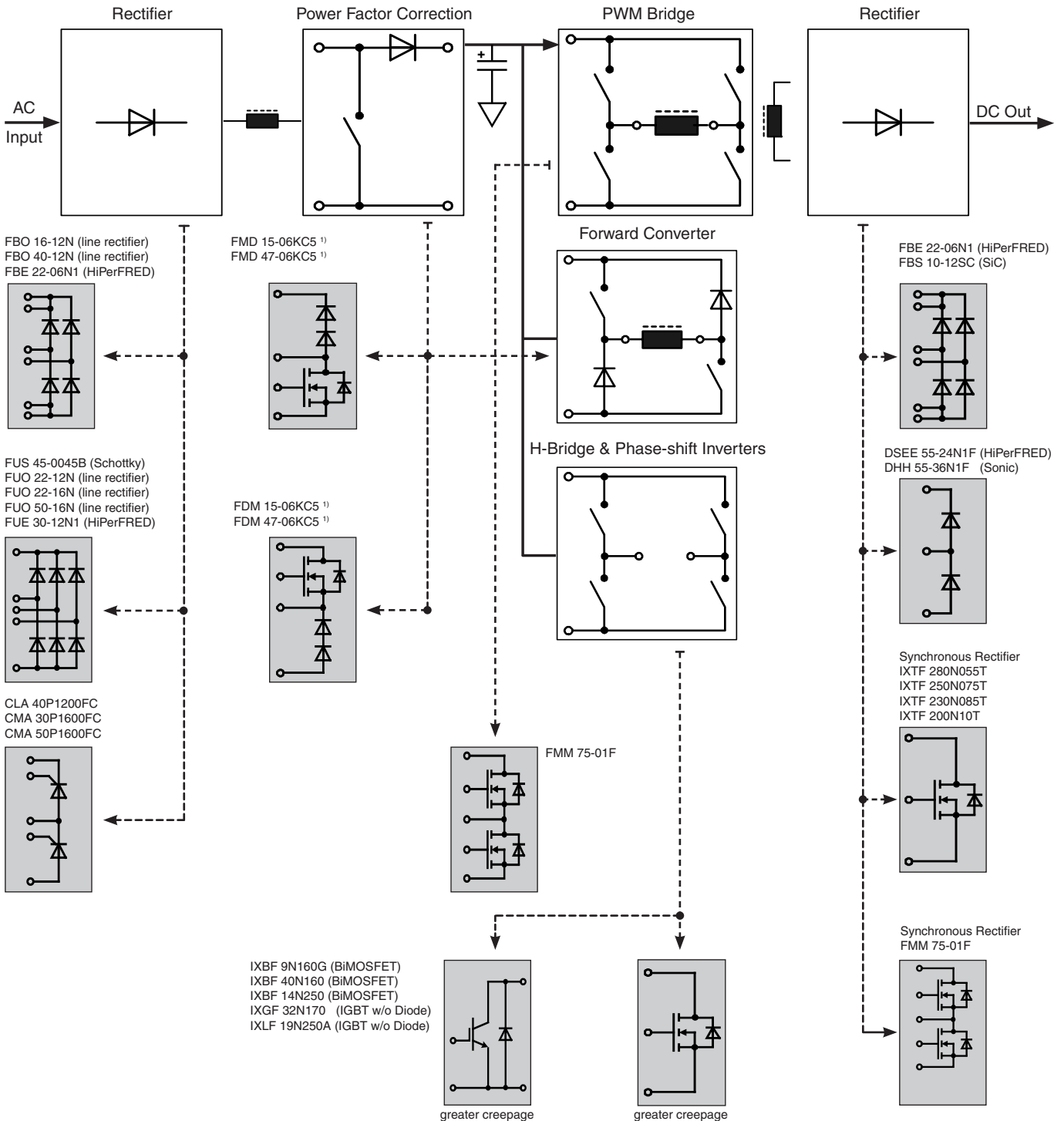
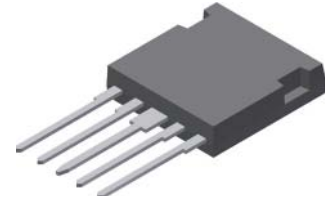

¹⁾ Powered by Infineon CoolMOS™ superjunction bare die

See application note „Combining the features of modules and discretes in a new Power Semiconductor packages“ for general description of the packaging technologies.

See alphanumeric index for the page number of the particular product.

MOSFETs

Type	Configuration	Circuit diagram / Technology	V _{DSS}	I _{D25} T _C = 25°C	I _{D90/110} T _C = 90°C (110°C)	R _{DS(on)} T _C = 25°C typ.	Fig. No.	Circuit Diagram Package
○ Not for new design			V	A	A	mΩ (Ω)		
IXTF 200N10T	Single	A Trench MOSFET	100	90	na	7	X024d	
IXKF 40N60SCD1		D MOSFET [®] & serial Schottky & HiPerFRED free wheeling Diode	600	38	25	60	X024a	
IXTF 6N200P3		A Polar3™ High Voltage MOSFET	2000	4	(2.3)	≤ (4.2)	X024c	
IXTF 2N300P3		A Polar3™ High Voltage MOSFET	3000	1.6	(0.9)	≤ (21)		
IXTF 1N250		A High Voltage MOSFET	2500	1	na	≤ (40)		
IXTF 1R4N450		A High Voltage MOSFET	4500	1.4	na	≤ (40)		
IXTF 02N450		A High Voltage MOSFET		0.2	na	≤ (625)		
IXTF 1N450		A High Voltage MOSFET		0.9	na	≤ (80)		
FMD 15-06KC5	Boost	C MOSFET [®] & HiPerDynFRED	600	15	11	150	X024a	
○ FMD 40-06KC		C MOSFET [®] & HiPerDynFRED		38	25	60		
○ FMM 75-01F	Phase leg	B HiPerFET	100	75	50	18		
FMP 76-010T *		G Trench™ P & N-Channel	±100	-54 / 62	na	24 / 11		
FMP 36-015P *		G Polar™ P & N-Channel	±150	-22 / 36	na	110 / 40		
FMP 26-02P *		G Polar™ P & N-Channel	±200	-17 / 26	na	170 / 60		
FMM 60-02TF		B Trench HiPerFET	200	33	na	32		
FMM 50-025TF		B Trench HiPerFET	250	30	na	≤ 60		
FMM 22-05PF		B PolarHV™ HiPerFET	500	13	na	≤ 270		
FMM 22-06PF		B PolarHV™ HiPerFET	600	12	na	≤ 350		

* high side switch: p-channel; low side switch: n-channel

IGBTs / BiMOSFETs

Type	Configuration	Circuit diagram / Technology	V _{CES}	I _{C25} T _C = 25°C	I _{C90/110} T _C = 90°C (110°C)	V _{CE(sat)} typ. T _C = 25°C	Fig. No.	Outline drawings on pages O-36...O-59
			V	A	A	V		
IXYF 30N170CV1	Single	F High voltage XPT™ IGBT	1700	36	(20)	3.5	X024c	
IXGF 32N170		E High voltage IGBT			44	(19)		
IXGF 20N250		E High voltage IGBT	2500	23	14	≤ 3.1	X024a	
IXGF 25N250		E High voltage IGBT		30	(15)	≤ 2.9		
IXLF 19N250A		E High voltage IGBT		32	19	3.2		
IXYF 16N250CV1		F High voltage XPT™ IGBT		26	(14)	3.3	X024c	
IXBF 14N300		F BiMOSFET	28	14	2.2			
IXBF 22N300		F BiMOSFET	38	22	2.2			
IXBF 32N300		F BiMOSFET	40	22	2.8			
IXBF 28N300		F BiMOSFET	50	28	2.3			
IXBF 42N300		F BiMOSFET	60	(24)	2.5			
IXBF 55N300		F BiMOSFET	86	(34)	2.7			
IXBF 16N360		F BiMOSFET	3600	26	16	2.5		
IXBF 20N360		F BiMOSFET		45	(18)	2.9		
IXBF 50N360		F BiMOSFET		70	(28)	2.4		
IXYF 30N450		E High voltage XPT™ IGBT	4500	23	(17)	3.2		
IXYF 40N450		E High voltage XPT™ IGBT		60	(32)	3.2		

Bipolar

Type	Configuration	Circuit diagram / Diode type	Voltage V	$I_{D(AV)M}$ $T_c = 90^\circ\text{C}$ A	Fig. No.	Circuit Diagram
○ Not for new design						
CS 20-22moF1 DNA 30E2200FE	Single High voltage	N Thyristor O Rectifier	2200	18 30	X024c X024e	
CS 20-25mo1F		N Thyristor	2500	18	X024c	
CLA 40P1200FC DSEE 55-24N1F	Phase leg	M Thyristor H HiPerFRED	2x 1200	40 55	X024a X024b	
CMA 30P1600FC CMA 50P1600FC		M Thyristor M Thyristor	2x 1600	30 50	X024a	
DHH 55-36N1F		H Sonic-FRD	2x 1800	50	X024b	
FBE 22-06N1	1-Phase bridge	J HiPerFRED	600	20	X024a	
FBS 10-12SC FBO 16-12N FBO 40-12N		I Si-Carbide J Rectifier J Rectifier	1200	10 22 40		
○ FUS 45-0045B	3-Phase bridge	L Schottky	45	45		
FUO 22-12N FUE 30-12N1		K Rectifier K HiPerFRED	1200	27 30		
FUO 22-16N FUO 50-16N		K Rectifier K Rectifier	1600	27 50		

Outline drawings on pages O-36...O-59

X024a
ISOPLUS_i4pac(5)

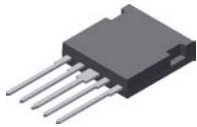

X024b
ISOPLUS_i4pac(3sym)

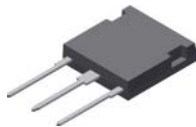

X024c
ISOPLUS_4pac(3asym)

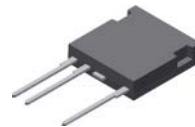

X024e
ISOPLUS_i4pac(2sym)

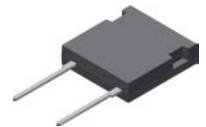

Insulated Gate Bipolar Transistors (IGBT)

The Insulated Gate Bipolar Transistor (IGBT) is a three terminal device combining high efficiency with fast switching capabilities. IXYS offers various IGBT technologies optimized for the many topologies, circuits and requirements in today's varied power semiconductor applications. As a guide to the multiple technologies of IGBT on offer from IXYS please refer to the following characteristics.

$V_{CE(sat)}$ – a measure of on-state losses, i.e. power dissipation when the device is passing forward current. The higher the $V_{CE(sat)}$ the higher the losses in the forward direction.

Switching Speed – an IGBT with fast switching speed will have higher efficiency during the transition from on to the off state and vice versa. Low switching speed versions are often combined with low $V_{CE(sat)}$ for low frequency applications. Higher speed IGBT tend to have higher $V_{CE(sat)}$.

Temperature Coefficient – this determines the device $V_{CE(sat)}$ trend against temperature. A device is said to have a positive temperature coefficient if the $V_{CE(sat)}$ rises when the junction temperature increases. Likewise a negative temperature coefficient is when the devices $V_{CE(sat)}$ reduces when the junction temperature increases. A positive temperature coefficient is required when operating IGBT in parallel. A negative temperature coefficient device cannot be operated in parallel but may have lower losses at higher temperatures.

Safe Operating Area (SOA) – the ability for an IGBT to sustain voltage and current in shorter time scales without failure. Forward bias (FBSOA) is SOA when turning the IGBT into the on-state. Reverse Bias (RBSOA) is SOA when turning to the off-state. Short circuit SOA (SCSOA) is an indication of ability to withstand surge currents in operation.

Avalanche Rated – the ruggedness of the IGBT in the avalanche region. An avalanche rated devices is far more rugged than altertive devices during operation and is an indication of reliability.

IGBT technology

IGBT Characteristic	Non-Punch Through (NPT)	XPT Planar	XPT GenX3		XPT Trench		BiMOSFET (RC IGBT)			High voltage IGBT		
Discrete Part No. Prefix	IXD..	IXA..	IXY..		IXX..		IXB..			IXG..		
Discrete Part No. Suffix	NONE	NONE	B3	C3	B4	C4	NONE	A (1700V)	C	NONE	A	C
$V_{CE(sat)}$	MEDIUM	MEDIUM	MED.	HIGH	LOW	MED.	LOW	MED.	HIGH	LOW	MED.	HIGH
Switching Speed	MEDIUM	MEDIUM	MED.	HIGH	MED.	HIGH	LOW	MED.	MED.	LOW	MED.	MED.
Temperature Coefficient	POSITIVE	POSITIVE	POSITIVE		POSITIVE		POSITIVE			POSITIVE		
Safe Operating Area	SCSOA RBSOA FBSOA	SCSOA RBSOA FBSOA	SCSOA RBSOA FBSOA	SCSOA RBSOA FBSOA	SCSOA RBSOA		SCSOA RBSOA			SCSOA RBSOA FBSOA		
Avalanche Rated	YES	YES	YES		NO		NO			YES		
Voltage Range	600-1700V	600-1200V	650 / 650 / 900 / 1200V		650V		1600-3000V			1600-4500V		

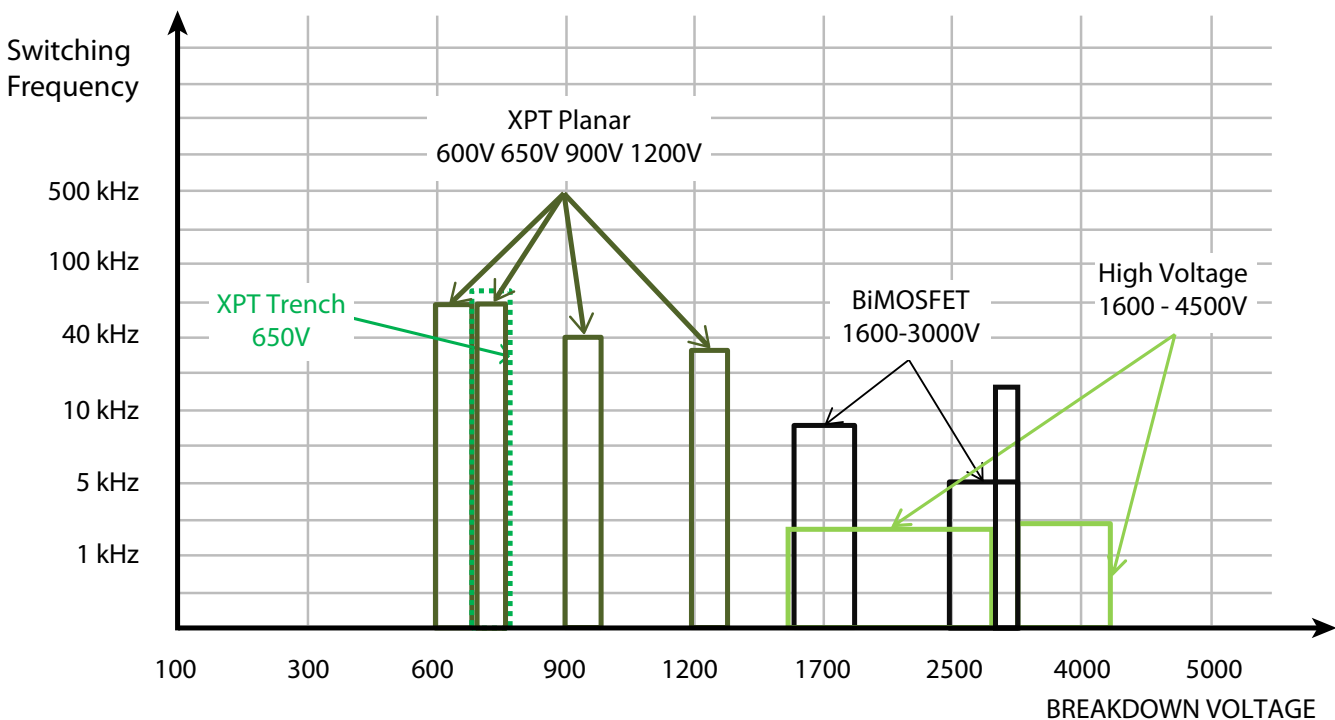

Insulated Gate Bipolar Transistors (IGBT)

IGBT product families

Xtreme Light Punch Through (XPT™) Planar IGBTs

are an extremely rugged technology platform of IGBTs, which are ideal for critical applications that require low conduction and low switching losses with a 10 μ s short circuit withstand capability. Either discrete or co-packaged with ultrafast soft recovery Sonic diodes. IXYS XPT IGBTs have lower saturation voltage $V_{CE(sat)}$ and low total switching energy ($E_{on} + E_{off}$). A large portfolio of module packed Planar XPTs are available for applications such as UPS, Motor Drive and solar inverters.

Xtreme Light Punch Through (X2PT™) Planar IGBTs

are the second generation of XPT IGBTs. Features are 10 μ s short circuit capability, 175°C max junction temperature, further reduced $V_{CE(sat)}$ and lower turn-off losses (E_{off}) resulting in a competitive performance to latest trench devices at reduced R_{th} . Thus they are ideally suited for Motor Drive inverters.

Xtreme Light Punch Through (XPT™) Trench IGBTs

are the latest development from IXYS starting at 650 V. This range features not only a low $V_{CE(sat)}$ but extremely low switching losses making the platform attractive for fast switching applications whilst retaining good SOA rating and a positive temperature coefficient. Either discrete or co-packaged with ultrafast soft recovery Sonic diodes. IXYS XPT IGBTs have industry leading efficiency at medium to high switching frequency.

1600 V & 1700 V Low Sat IGBTs

These rugged High Voltage NPT devices are designed for capacitor discharge applications. featuring a low saturation voltage, high power density & high peak current capability. These High Voltage NPT IGBTs enable the elimination of more costly, lower performance solutions such as thyristors or series connected MOSFETs or IGBTs typically used at voltages above 1200 V. Offered as co-packs, they provide a more complete solution for power conversion applications.

1600 V & 1700 V High Speed IGBTs

This family of 1600/1700 V IGBTs are rugged NPT devices targeted for high voltage applications, requiring 10 μ s short circuit withstand capability. They are particularly suitable for high voltage switching applications. IXYS offers its fast switching "A" version 1700 V NPT IGBTs in co-pack and phase-leg configurations for PWM applications with switching frequencies upwards of 50 kHz.

Very High Voltage (2500 V - 4000 V) IGBTs

IXYS offers a unique portfolio of discrete 2500 V, 3000 V and 4000 V VHV IGBTs with collector current ratings spanning from 2 A to 75 A ($T_c = 110^\circ\text{C}$). The voltage and current ratings of these devices, coupled with simplified MOS gate-control, allow the system designer to greatly reduce the complexity of many high voltage switching designs. These IGBTs enable the use of a single device in systems whose circuits previously used multiple, cascaded, lower-voltage switches.

B-series (BiMOSFET) IGBTs

IXYS BiMOSFETs are devices which have combined strengths of MOSFETs and IGBTs. BiMOSFETs feature a monolithic intrinsic diode which can reduce die count in many applications.



Ignition IGBTs and Relevant Peripheral Components

Littelfuse offers a broad portfolio of high performance Ignition IGBTs for gasoline-powered passenger vehicles and motorcycles. In addition, Littelfuse has extensive experience with protection devices which ensures we can cover your needs for reliable automotive quality grade designs.



Littelfuse Ignition IGBTs manage and control the current across the coil for a precise spark generation. They contain an integrated clamp structure and gate ESD protection in the silicon. Ignition IGBTs provide an exceptionally low saturation voltage while conducting the current.

More than 28 million new cars are powered by Littelfuse Ignition IGBTs every year around the world. Also, Littelfuse Ignition IGBTs are the preferred solution for high performance premium motorcycles.

Ignition IGBTs

Part Number	V_{CES}	I_{Cmax}	$V_{CE(sat)}$	E_{AS}	Fig. No.	Package style Outline drawings on pages O-60...O-64
	@ I_C V					
NGD8205ANT4G	350	20	1.30	250	L004	L004 TO-252AA 
NGD18N40ACLBT4G	400	18	1.80	400		
NGD8201ANT4G	400	20	1.30	250		
NGD8201BNT4G	400	20	1.50	435		
NGD15N41ACL4G	410	15	1.90	250		
NGD8209NT4G	410	12	1.80	274		
NGD18N45CLBT4G	450	18	2.07	360		
NGB8207ABNT4G	365	20	1.75	500	L011b	L011b TO-263AB 
NGB8206ANTF4G	350	20	1.30	250		
NGB8207BNT4G	365	20	1.50	500		
NGB8204ANT4G	400	18	1.80	400		
NGB8202ANT4G	400	20	1.30	250		
NGB18N40ACLBT4G	400	18	1.80	400		
NGB15N41ACL4G	410	15	1.90	250		
NGB8245NT4G	450	20	1.10	158		

TVS Diodes for Ignition Applications

Part Number	V_R Range		P_{PP} 10x1000 μ s V	P_{PP} 10x15ms mJ	Fig. No.	Package style Outline drawings on pages O-60...O-64
	min. V	max. V				
TPSMB	5.8	468	600	2200 load dump	L003a	L003a/b DO-214AA/AB 
TPSMB-VR	6.5	150	600			
TPSMC	10.2	77.8	1500		L003b	L007 SMT0-263 
TPSMD	10.0	85	3000			
SLD8S	12.0	57	7000			

Resettable PTCs for Ignition Applications

Part Number	Current @ 0°C		Current @ 25°C		Current @ 60°C		Time to Trip max. s	Resistance @ 25°C		Tripped State Power Dissipation max. W	Fig. No.	Package style Outline drawings on pages O-60...O-64
	HOLD A	TRIP A	HOLD A	TRIP A	HOLD A	TRIP A		min. Ω	max. Ω			
nanoASMD016F-2	0.18	0.7	0.16	0.45	0.012	0.028	0.3	1.1	5	0.5	L008	L008 1206 

Ignition IGBTs and Relevant Peripheral Components

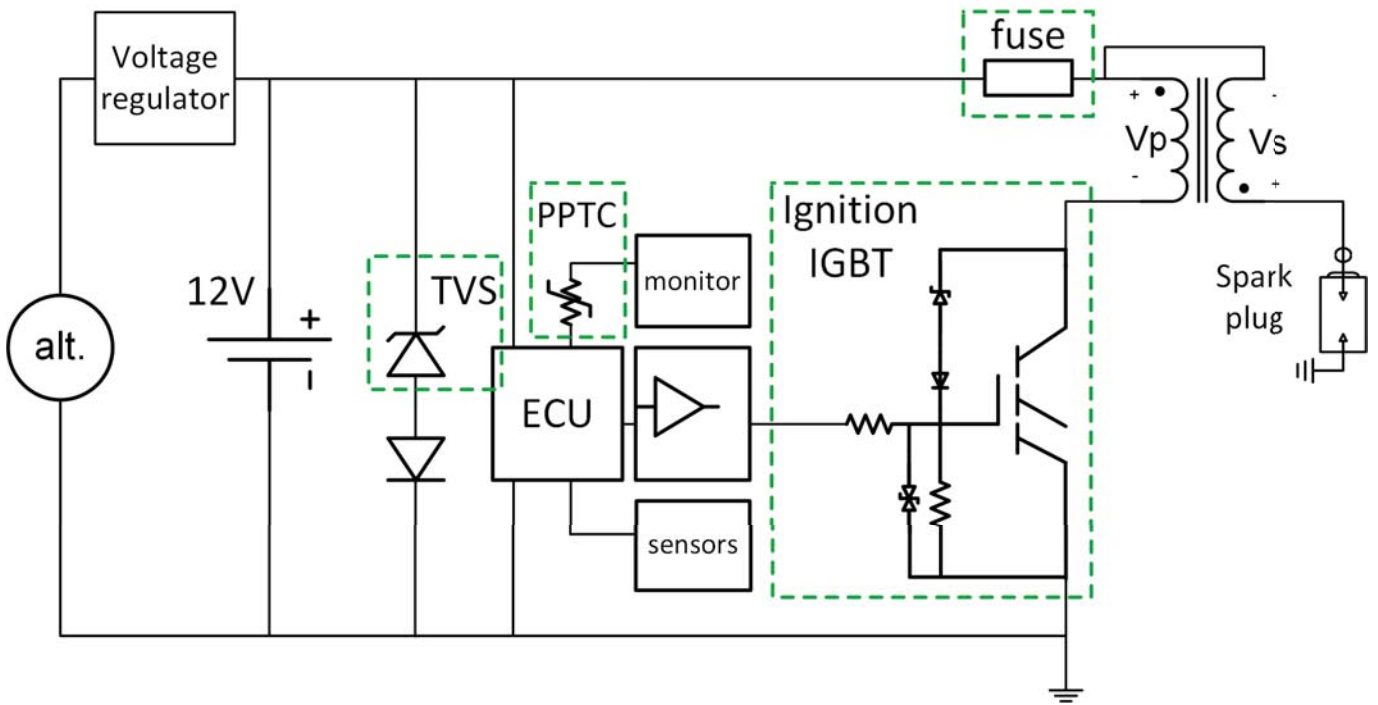

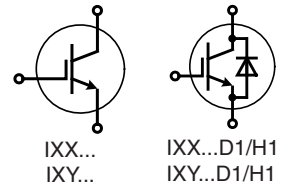

Fuses for Ignition Applications

Part Number	Current	Voltage max.	Resistance	Melting I^2t	Voltage Drop at Rated Current	Dissipation at Rated Current	Fig. No.	Package style
440A Series	A	V	Ω	A ² s	V	W		Outline drawings on pages O-60...O-64
0440 005.WRA	5	32	12	4.761	0.0654	0.327	L008	
0440 007.WRA	7		7.53	8.464	0.0696	0.487		
0440 008.WRA	8		6.34	12.95	0.0655	0.524		









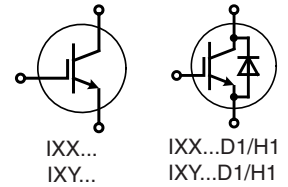



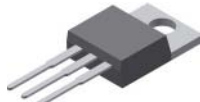



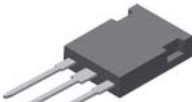



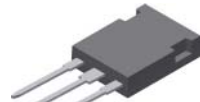
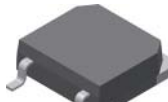

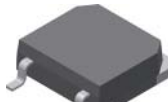

600 V XPT™ Planar IGBTs

XPT = Xtreme light Punch Through, short-circuit rated IGBTs

Part Number	V _{CEs} V	I _{C25}	I _{C110}	V _{CE(sat)}	t _{ri}	E _{off}	R _{thJC}	I _{F110} Diode T _C = 110°C A	R _{thJC} Diode max. K/W	P _C W	Fig. No.	Package style Outline drawings on pages O-36...O-59
		T _C = 25°C A	T _C = 110°C A	T _C = 25°C V	typ. T _J = 150°C ns	typ. T _J = 150°C mJ	K/W					
B3 Class (5-30 kHz switching)												
IXXQ 30N60B3M	600	33	19	1.85	180	0.70	1.660			90	X017c	X005a TO-220AB 
IXXH 30N60B3		60	30	1.85	180	0.70	0.550			270	X014a	
IXXH 30N60B3D1		60	30	1.85	180	0.70	0.550	• 30	0.90	270	X014a	
IXXA 50N60B3		120	50	1.80	190	1.20	0.250			600	X011b	
IXXH 50N60B3		120	50	1.80	190	1.20	0.250			600	X014a	
IXXH 50N60B3D1		120	50	1.80	190	1.20	0.250	• 30	0.90	600	X014a	
IXXP 50N60B3		120	50	1.80	190	1.20	0.250			600	X005a	
IXXR 100N60B3H1		145	68	1.80	200	2.80	0.310	• -	0.62	400	X016a	X011b TO-263AB 
IXXH 75N60B3		160	75	1.85	170	2.20	0.200			750	X014a	
IXXH 75N60B3D1		160	75	1.85	170	2.20	0.200	• 30	0.90	750	X014a	
IXXN 100N60B3H1		170	100 (90°C)	1.80	200	2.80	0.250	• 50	0.42	500	X027a	
IXXK 100N60B3H1		200	100 (100°C)	1.80	200	2.80	0.180	• 65	0.30	695	X020a	
IXXN 200N60B3H1		200	98	1.70	215	3.45	0.160	• 30	0.70	780	X027a	
IXXX 100N60B3H1		200	100 (100°C)	1.80	200	2.80	0.180	• 65	0.30	695	X015a	
IXXH 100N60B3		220	100	1.80	200	2.80	0.180			830	X014a	X014a TO-247AD 
IXXN 200N60B3		280	160	1.70	215	3.45	0.160			940	X027a	
IXXK 200N60B3		380	200	1.70	215	3.45	0.092			1630	X020a	
IXXX 200N60B3		380	200	1.70	215	3.45	0.092			1630	X015a	
IXXK 300N60B3		550	300	1.60	200	3.70	0.065			2300	X020a	
IXXX 300N60B3		550	300	1.60	200	3.70	0.065			2300	X015a	
C3 Class (20-60 kHz switching)												
IXXH 30N60C3	600	60	30	2.20	32	0.40	0.550			270	X014a	X015a PLUS247 
IXXH 30N60C3D1		60	30	2.20	78	0.40	0.550	• 30	0.90	270	X014a	
IXXH 50N60C3		100	50	2.30	90	0.48	0.250			600	X014a	
IXXH 50N60C3D1		100	50	2.30	90	0.48	0.250	• 30	0.90	600	X014a	
IXXH 75N60C3		150	75	2.30	80	1.07	0.200			750	X014a	
IXXH 75N60C3D1		150	75	2.30	80	1.07	0.200	• 30	0.90	750	X014a	
IXXK 100N60C3H1		170	100 (90°C)	2.20	115	1.40	0.180	• 65	0.30	695	X020a	
IXXX 100N60C3H1	170	100 (90°C)	2.20	115	1.40	0.180	• 65	0.30	695	X015a	X016a ISOPLUS247™ 	
IXXH 100N60C3	190	100	2.20	115	1.40	0.180			830	X014a		
IXXN 200N60C3H1	200	98	2.10	90	2.10	0.160	• 30	0.70	780	X027a		
IXXK 200N60C3	340	200	2.10	90	2.10	0.092			1630	X020a		
IXXX 200N60C3	340	200	2.10	90	2.10	0.092			1630	X015a		
IXXK 300N60C3	510	300	2.00	90	2.35	0.065			2300	X020a		
IXXX 300N60C3	510	300	2.00	90	2.35	0.065			2300	X015a		
X027a	SOT-227B miniBLOC											
X020a	TO-264											
X017c	TO-3PFP											



650V XPT™ Planar IGBTs XPT = Xtreme light Punch Through, short-circuit rated IGBTs

Part Number	V _{CES}	I _{C25}	I _{C110}	V _{CE(sat)}	t _{fi} typ.	E _{off} typ.	R _{thJC}	Diode	I _{F110}	R _{thJC}	P _C	Fig. No.	Package style Outline drawings on pages O-36...O-59
		T _C = 25°C	T _C = 110°C	T _C = 25°C	T _J = 150°C	T _J = 150°C	K/W		Diode T _C = 110°C	max. Diode	W		
➤ New													
A3 Class (up to 5kHz switching)													
IXYN 100N65A3	650	170	100	1.80	160	2.40	0.25				600	X027a	X005a TO-220AB 
IXYH 100N65A3		240	100	1.80	225	3.70	0.18				470	X014a	
IXYN 300N65A3		470	300	1.60	175	7.30	0.10				1500	X027a	
IXYK 300N65A3		600	300	1.60	175	7.30	0.065				2300	X020a	
IXYX 300N65A3		600	300	1.60	175	7.30	0.065				2300	X015a	
B3 Class (10-30 kHz switching)													
IXYP 10N65B3D1	650	32	19	1.95	116	0.36	0.94	•	9	2.30	160	X005a	X011b TO-263AB 
IXYA 20N65B3		58	20	2.10	147	0.76	0.65				230	X011b	
IXYH 20N65B3		58	20	2.10	147	0.76	0.65				230	X014a	X011c TO-263ABHV 
IXYP 20N65B3		58	20	2.10	147	0.76	0.65				230	X005a	
IXYP 20N65B3D1		58	20	2.10	147	0.76	0.65	•	23	1.85	230	X005a	X014a TO-247AD 
IXYQ 30N65B3D1		70	30	2.10	93	1.00	0.55	•	50	0.60	270	X017a	
IXYH 30N65B3D1		70	30	2.10	93	1.00	0.55	•	50	0.60	270	X014a	X014a PLUS247 
IXYH 40N65B3		86	40	2.00	174	1.15	0.50				300	X014a	
IXYQ 40N65B3D1		86	40	2.00	174	1.15	0.50	•	50	0.60	300	X017a	X015a TO-268AAHV 
IXYH 40N65B3D1		86	40	2.00	174	1.15	0.50	•	50	0.60	300	X014a	
IXYN 100N65B3D1		185	100	1.85	160	2.16	0.25	•	67	0.40	600	X027a	X020a TO-264 
IXYH 100N65B3		225	100	1.85	160	2.16	0.18				830	X014a	
IXYK 100N65B3D1		225	100	1.85	160	2.16	0.18	•	67	0.36	830	X020a	X027a SOT-227B miniBLOC 
IXYX 100N65B3D1		225	100	1.85	160	2.16	0.18	•	67	0.36	830	X015a	
IXYN 120N65B3D1		250	120	1.90	196	2.20	0.18	•	86	0.38	830	X027a	X014a
IXYH 120N65B3		340	120	1.90	196	2.20	0.11					X014a	
IXYK 200N65B3		410	200	1.70	230	5.60	0.096					X020a	X014a
IXYX 200N65B3		410	200	1.70	230	5.60	0.096					X015a	
C3 Class (20-60 kHz switching)													
IXYP 10N65C3	650	30	10	2.50	38	0.15	0.94				160	X005a	X017a TO-3P 
IXYP 10N65C3D1		30	10	2.50	38	0.15	0.94	•	23	1.85	160	X005a	
IXYA 15N65C3D1		38	15	2.50	42	0.24	0.75	•	23	1.85	200	X011b	X019a TO-268AAHV 
IXYP 15N65C3		38	15	2.50	42	0.24	0.75				200	X005a	
IXYP 15N65C3D1		38	15	2.50	42	0.24	0.75	•	23	1.85	200	X005a	X020a TO-264 
IXYA 20N65C3		50	20	2.50	36	0.40	0.65				230	X011b	
IXYA 20N65C3D1		50	20	2.50	36	0.40	0.65	•	18	1.85	200	X011b	X019a TO-268AAHV 
IXYH 20N65C3		50	20	2.50	36	0.40	0.65				230	X014a	
IXYP 20N65C3D1		50	20	2.50	36	0.40	0.65	•	18	1.85	200	X005a	X020a TO-264 
IXYH 30N65C3H1		60	30	2.70	30	0.41	0.55	•	29	0.80	270	X014a	
IXYH 30N65C3		60	30	2.70	30	0.41	0.55				270	X014a	X027a SOT-227B miniBLOC 
IXYT 30N65C3H1HV		60	30	2.70	30	0.41	0.55	•	29	0.80	270	X019a	
IXYP 30N65C3		60	30	2.70	30	0.41	0.55				270	X005a	X020a TO-264 
IXYQ 40N65C3D1		80	40	2.35	30	0.53	0.50	•	50	0.60	300	X017a	
IXYH 40N65C3		80	40	2.35	30	0.53	0.50				300	X014a	X027a SOT-227B miniBLOC 
IXYH 40N65C3H1		80	40	2.35	80	0.46	0.50	•	40	0.60	300	X014a	
IXYH 40N65C3D1		80	40	2.35	30	0.53	0.50	•	50	0.60	300	X014a	X020a TO-264 
IXYH 50N65C3H1		130	50	2.10	42	0.56	0.25	•	40	0.60	600	X014a	
IXYP 50N65C3		132	50	2.10	32	0.70	0.25				600	X005a	X027a SOT-227B miniBLOC 
IXYH 50N65C3D1		132	50	2.10	32	0.70	0.25	•	50	0.60	600	X014a	
IXYH 50N65C3		132	50	2.10	32	0.70	0.25				600	X014a	X020a TO-264 
IXYA 50N65C3		132	50	2.10	32	0.70	0.25				600	X011b	
IXYN 75N65C3D1		150	75	2.30	64	1.30	0.25	•	60	0.52	600	X027a	X027a SOT-227B miniBLOC 
IXYN 100N65C3H1		160	90	2.30	66	1.15	0.25	•	50	0.42	600	X027a	
IXYH 75N65C3H1		170	75	2.30	58	1.30	0.20	•	62	0.45	750	X014a	X020a TO-264 
IXYH 75N65C3		175	75	2.30	64	1.30	0.20				750	X014a	
IXYH 75N65C3D1		175	75	2.30	64	1.30	0.20	•	62	0.45	750	X014a	X027a SOT-227B miniBLOC 
IXYN 120N65C3D1		190	100	2.80	60	0.70	0.18	•	72	0.38	830	X027a	
IXYX 100N65C3D1		200	100	2.30	66	1.15	0.18	•	67	0.36	830	X015a	X020a TO-264 
IXYH 100N65C3		200	100	2.30	66	1.15	0.18				830	X014a	
IXYK 100N65C3D1		200	100	2.30	66	1.15	0.18	•	67	0.36	830	X020a	X014a
IXYH 120N65C3		260	120	2.80	60	0.70	0.11					X014a	

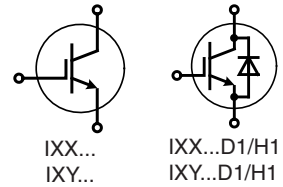







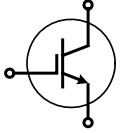

650 V XPT™ Trench IGBTs

XPT = Xtreme light Punch Through, short-circuit rated IGBTs

Part Number	V _{CES}	I _{C25}	I _{C110}	V _{CE(sat)}	t _{fi} typ.	E _{off} typ.	R _{thJC}	Diode	I _{F110}	R _{thJC}	P _C	Fig. No.	Package style Outline drawings on pages O-36...O-59
		T _C = 25°C	T _C = 110°C	T _C = 25°C	T _J = 150°C	T _J = 150°C	A		max. Diode	W			
A4 Class (5-20 kHz switching)													
IXXN 200N65A4	650	440	200	1.80	190	8	0.12				1250	X027a	X005a TO-220AB 
B4 Class (10-30 kHz switching)													
IXXP 12N65B4	650	38	12	1.95	110	0.38	0.940				160	X005a	X007a TO-220ABFP 
IXXP 12N65B4D1		38	12	1.95	110	0.38	0.940	• 11	2.30	160	X005a		
IXXH 30N65B4		70	30	2.00	60	1.07	0.650				230	X014a	X014a TO-247AD 
IXXH 30N65B4D1		70	30	2.00	60	1.07	0.650	• 40	0.75	230	X014a		
IXXH 40N65B4		115	40	2.00	116	1.30	0.330				455	X014a	X014a TO-247AD 
IXXH 40N65B4D1		115	40	2.00	116	1.30	0.330	• 50	0.60	455	X014a		
IXXH 60N65B4		120	60	2.20	88	1.80	0.330				536	X014a	X014a TO-247AD 
IXXH 60N65B4H1		120	60	2.20	88	1.80	0.330	• 47	0.60	536	X014a		
IXXH 40N65B4H1		123	40	2.00	73	1.40	0.330	• 40	0.60	455	X014a	X016a PLUS247 	
IXXR 110N65B4H1		150	70	2.20	105	1.40	0.330	• 48	0.70	455	X016a		
IXXH 80N65B4		160	80	2.10	94	2.70	0.240				625	X014a	X015a PLUS247 
IXXH 80N65B4H1		160	80	2.10	102	3.10	0.240	• 62	0.45	625	X014a		
IXXH 80N65B4D1		180	80	2.10	94	2.70	0.240	• 65	0.47	625	X014a	X016a ISOPLUS247™ 	
IXXN 110N65B4H1		230	110	2.10	110	2.16	0.200	• 70	0.42	750	X027a		
IXXH 110N65B4		250	110	2.10	110	2.16	0.170				880	X014a	X016a ISOPLUS247™ 
IXXK 110N65B4H1		250	110	2.10	110	2.16	0.170	• 78	0.38	880	X020a		
IXXX 110N65B4H1		250	110	2.10	110	2.16	0.170	• 78	0.38	880	X015a	X020a TO-264 	
IXXK 160N65B4		310	160	1.80	160	2.36	0.160				940		X020a
IXXX 160N65B4		310	160	1.80	160	2.36	0.160				940	X015a	X027a SOT-227B miniBLOC 
IXXH 140N65B4		340	140	1.90	100	3.90	0.125				1200	X014a	
IXXX 140N65B4H1		350	140	1.90	100	3.90	0.125	• 72	0.24	1200	X015a	X020a TO-264 	
IXXK 200N65B4		480	200	1.70	120	5.00	0.092				1630		X020a
IXXX 200N65B4		480	200	1.70	120	2.54	0.092				1630	X015a	X020a TO-264 
IXXN 340N65B4		520	340 (90°C)	1.70	110	2.54	0.100				1500	X027a	
C4 Class (20-60 kHz switching)													
IXXH 30N65C4D1	650	62	30	2.5	34	0.44	0.65	• 30	0.75	230	X014a	X027a SOT-227B miniBLOC 	
IXXH 40N65C4D1		110	40	2.3	36	0.64	0.33	• 55	0.6	455	X014a		
IXXH 60N65C4		125	60	2.4	54	1.5	0.33				536	X014a	X027a SOT-227B miniBLOC 
IXXN 110N65C4H1		210	110	2.35	40	0.9	0.2	• 70	0.42	750	X027a		
IXXH 110N65C4		235	110	2.35	40	0.9	0.17				880	X014a	X020a TO-264 
IXXK 160N65C4		290	160	2.1	57	1.3	0.16				940	X020a	
IXXX 160N65C4		290	160	2.1	57	1.3	0.16				940	X015a	X027a SOT-227B miniBLOC 
IXXH 140N65C4		320	160	2.3	63	2.5	0.125				1200	X014a	



1200 V XPT™ Trench IGBTs XPT = Xtreme light Punch Through,

Part Number	V _{CES}	I _{C25} T _C = 25°C	I _{C110} T _C = 110°C	V _{CE(sat)} T _C = 25°C	t _{fi} typ. T _J = 125°C	E _{off} typ. T _J = 125°C	R _{thJC}	P _C	Fig. No.	Package style
➤ New	V	A	A	V	ns	mJ	K/W	W		Outline drawings on pages O-36...O-59
A4 Class (up to 5kHz switching)										
IXYA 20N120A4HV	1200	80	20	1.9	286	4.85	0.40	375	X011c	X005a TO-220AB 
IXYP 20N120A4		80	20	1.9	286	4.85	0.40	375	X005a	
IXYA 30N120A4HV		106	30	1.9	270	5.60	0.30	500	X011c	
IXYH 30N120A4		106	30	1.9	270	5.60	0.30	500	X014a	
IXYP 30N120A4		106	30	1.9	270	5.60	0.30	500	X005a	
➤ IXYH 40N120A4		150	40	1.8	365	8.30	0.22	680	X014a	
➤ IXYT 40N120A4HV		150	40	1.8	365	8.3	0.22	680	X019a	X011c TO-263ABHV 
➤ IXYT 55N120A4HV		175	55	1.8	270	8.8	0.23	650	X019a	
➤ IXYH 55N120A4		175	55	1.8	270	8.8	0.23	650	X014a	
➤ IXYT 85N120A4HV		300	85	1.8	280	13.7	0.13	1150	X019a	
➤ IXYH 85N120A4		300	85	1.8	280	13.7	0.13	1150	X014a	
➤ IXYK 140N120A4		480	140	1.7	320	20	0.10	1500	X020a	
➤ IXYN 140N120A4	480	140	1.7	320	20	0.14	1070	X027a	X014a TO-247AD 	
➤ IXYX 140N120A4	480	140	1.7	320	20	0.10	1500	X015a		
B4 Class (5-30 kHz switching)										
➤ IXYA 20N120B4HV	1200	76	20	2.1	170	2.70	0.40	375	X011c	X015a PLUS247 
➤ IXYP 20N120B4		76	20	2.1	170	2.70	0.40	375	X005a	
➤ IXYH 30N120B4		100	30	2.1	190	4.00	0.30	500	X014a	
➤ IXYH 40N120B4		136	40	2.1	190	4.40	0.22	680	X014a	
C4 Class (20-50 kHz switching)										
➤ IXYA 20N120C4HV	1200	68	20	2.5	86	1.60	0.40	375	X011c	X015a PLUS247 
➤ IXYP 20N120C4		68	20	2.5	86	1.60	0.40	375	X005a	
➤ IXYH 30N120C4		94	30	2.4	100	2.70	0.30	500	X014a	
➤ IXYH 40N120C4		120	40	2.5	80	2.65	0.22	680	X014a	
X027a SOT-227B miniBLOC			X020a TO-264			X019a TO-268AAHV				
										

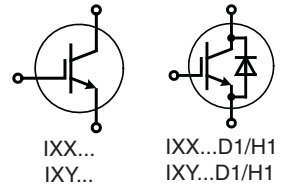

900/1200 V XPT™ Planar IGBTs

Part Number	V _{CES} V	I _{C25} T _C = 25°C A	I _{C110} T _C = 110°C (90°C) A	V _{CE(sat)} T _C = 25°C V	t _{ri} typ. T _J = 125°C (150°C) ns	E _{off} typ. T _J = 125°C (150°C) mJ	R _{thJC} K/W	Diode	I _{F110} T _C = 110°C A	R _{thJC} max. Diode K/W	P _C W	Fig. No.	Package style Outline drawings on pages O-36...O-59	
C3 Class (20-50 kHz switching)													X004	TO-252AA
IXYA 8N90C3D1	900	20	8	2.5	163	0.22	1.20	•	12	2.5	125	X011b		
IXYP 8N90C3		20	8	2.5	163	0.22	1.20	•	12	2.5	125	X005a		
IXYP 8N90C3D1		20	8	2.5	163	0.22	1.20	•	12	2.5	125	X005a		
IXYY 8N90C3		20	8	2.5	163	0.22	1.20	•	12	2.5	125	X004		
IXYH 24N90C3		44	24	2.7	130	0.55	0.62					240	X014a	
IXYH 24N90C3D1		44	-24	2.7	130	0.55	0.62	•	15	1.6	200	X014a		
IXYH 40N90C3D1		90	40	2.5	150	1.2	0.25	•	25	0.9	500	X014a		
IXYH 40N90C3		105	40	2.5	150	1.2	0.25	•	25	0.9	600	X014a		
IXYN 80N90C3H1		115	-70	2.7	-98	-2.5	0.25	•	42	0.42	500	X027a	X007a	TO-220ABFP
IXYH 60N90C3		140	60	2.7	-165	-2.15	0.20				750	X014a		
IXYH 80N90C3		165	80	2.7	-98	-2.5	0.18				830	X014a		
IXYT 80N90C3		165	80	2.7	-98	-2.5	0.18				830	X019		
IXYK 140N90C3		310	140	2.7	-125	-5	0.092				1630	X020a		
IXYX 140N90C3		310	140	2.7	-125	-5	0.092				1630	X015a		
B3 Class (5-30 kHz switching)														
IXYH 40N120B3D1	1200	86	40	2.9	206	2.05	0.26	•	25	0.9	480	X014a		
IXYH 40N120B3		96	40	2.9	206	2.05	0.26				577	X014a	X011c	TO-263ABHV
IXYN 100N120B3H1		165	76	2.6	° 260	10.1 °	0.18	•	42	0.42	690	X027a		
IXYK 100N120B3		225	100	2.6	° 260	10.1 °	0.13				1150	X020a		
IXYX 100N120B3		225	100	2.6	° 260	10.1 °	0.13				1150	X015a		
IXYK 120N120B3		320	120	2.2	° 406	27.9 °	0.10				1500	X020a	X014a	TO-247AD
IXYX 120N120B3		320	120	2.2	° 407	27.9 °	0.10				1500	X015a		
C3 Class (20-50 kHz switching)														
IXYH 20N120C3D1	1200	36	17	3.4	° 105	0.7 °	0.54	•	23	0.90	230	X014a		
IXYT 20N120C3D1HV		36	17	3.4	° 105	0.7 °	0.54	•	23	0.90	230	X019a	X015a	PLUS247
IXYA 20N120C3HV		40	20	3.4	° 105	0.7 °	0.54				278	X011c		
IXYH 20N120C3		40	20	3.4	° 105	0.7 °	0.54				278	X014a		
IXYP 20N120C3		40	20	3.4	° 105	0.7 °	0.54				278	X005a		
IXYR 50N120C3D1		56	* 32	4.0	° 60	1.4 °	0.43	•	25	0.90	290	X016a		
IXYH 30N120C3D1		66	30	4.0	88	0.9	0.30	•	25	0.90	416	X014a	X016a	ISOPLUS247™
IXYH 30N120C3		75	30	3.3	° 140	1.6 °	0.30				500	X014a		
IXYP 30N120C3		75	30	3.3	° 140	1.6 °	0.30				500	X005a		
IXYH 40N120C3D1		80	* 40	3.5	° 143	2.1 °	0.26	•	25	0.90	480	X014a		
IXYH 40N120C3		90	40	3.5	° 143	2.1 °	0.26				577	X014a		
IXYH 50N120C3D1		90	**50	4.0	° 60	1.4 °	0.20	•	25	0.90	625	X014a	X019	TO-268AA
IXYH 50N120C3		100	50	3.5	60	1.4	0.20				750	X014a		
IXYR 100N120C3		104	58	3.5	125	3.55	0.31				484	X016a		
IXYN 82N120C3H1		105	46	3.2	95	3.7	0.25	•	42	0.42	500	X027a	X019a	TO-268AAHV
IXYN 82N120C3		120	66	3.2	95	3.7	0.25				600	X027a		
IXYN 100N120C3H1		134	62	3.5	125	3.55	0.18	•	42	0.42	690	X027a		
IXYN 100N120C3		152	86	3.5	125	3.55	0.18				830	X027a		
IXYB 82N120C3H1		164	82	3.2	95	3.7	0.12	•	42	0.35	1040	X021a		
IXYK 100N120C3		188	100	3.5	125	3.55	0.13					X020a		
IXYX 100N120C3	188	100	3.5	125	3.55	0.13					X015a			
IXYH 82N120C3	200	82	3.2	95	3.7	0.12					X014a			
IXYK 120N120C3	240	120	3.2	° 120	7.2 °	0.10				1500	X020a	X020a	TO-264	
IXYX 120N120C3	240	120	3.2	° 120	7.2 °	0.10				1500	X015a			
IXYN 120N120C3	240	120	3.2	° 120	7.2 °	0.125				1200	X027a			

* T_C = 90°C ** T_C = 100°C ° T_J = 150°C

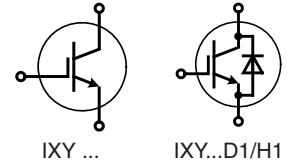

XPT™ Planar IGBT XPT = Xtreme light Punch Through

Part Number	V _{CES}	I _{C25} T _C = 25°C	I _{C110} T _C = 110°C	V _{CE(sat)} T _C = 25°C	t _{fi} typ. T _J = 150°C	E _{off} typ. T _J = 150°C	R _{thJC}	Diode	I _{F110} Diode T _C = 110°C	R _{thJC} max. Diode	P _C	Fig. No.
1700V XPT™ Planar IGBTs												
IXYH 10N170C	1700	36	10	4.1	94	0.90	0.53				280	X014a
IXYH 10N170CV1		36	10	4.1	94	0.90	0.53	•	22	0.70	280	X014a
IXYF 30N170CV1		36	20	4.0	134	3.50	0.65	•	20	0.86	230	X024c
IXYH 16N170C		40	16	3.8	140	1.95	0.48				310	X014a
IXYH 16N170CV1		40	16	3.8	140	1.95	0.48	•	22	0.70	310	X014a
IXYH 24N170C		58	24	4.0	140	2.66	0.30				500	X014a
IXYH 24N170CV1		58	24	4.0	140	2.66	0.30	•	28	0.55	500	X014a
IXYN 30N170CV1		80	30	4.0	134	3.50	0.22	•	33	0.43	680	X027a
IXYL 50N170CV1		90	46	3.7	160	8.20	0.26	•	26	0.83	580	X022e
IXYH 30N170C		100	30	4.0	134	3.50	0.16				937	X014a
IXYK 30N170CV1		100	30	4.0	134	3.50	0.16	•	38	0.36	937	X020a
IXYX 30N170CV1		100	30	4.0	134	3.50	0.16	•	38	0.36	937	X015a
IXYN 50N170CV1		120	50	3.7	160	8.20	0.17	•	42	0.42	880	X027a
IXYX 50N170C		178	50	3.7	160	8.20	0.10				1500	X015a
2500V XPT™ Planar IGBTs												
IXYF 16N250CV1	2500	26	14	4.0	236	4.40	0.83	•	9	1.50	180	X024c
IXYA 12N250CHV		28	12	4.5	138	1.95	0.48				310	X011c
IXYH 12N250CHV		28	12	4.5	138	1.95	0.48				310	X014c
IXYH 12N250CV1HV		28	12	4.5	138	1.95	0.48	•	14	0.80	310	X014c
IXYT 12N250CV1HV		28	12	4.5	138	1.95	0.48	•	14	0.80	310	X019a
IXYA 8N250CHV		29	8	4.0	128	1.20	0.53				280	X011c
IXYH 8N250CHV		29	8	4.0	128	1.20	0.53				280	X014c
IXYH 8N250CV1HV		29	8	4.0	128	1.20	0.53	•	14	0.80	280	X014c
IXYH 16N250CV1HV		38	16	4.0	236	4.40	0.30	•	14	0.80	500	X014c
IXYL 40N250CV1		80	40	4.0	250	11.50	0.26	•	23	0.83	577	X022e
IXYH 25N250CHV		95	25	4.0	350	10.50	0.16				937	X014c
IXYT 25N250CHV		95	25	4.0	350	10.50	0.16				937	X019a
IXYX 25N250CV1		95	25	4.0	350	10.50	0.16	•	30	0.32	937	X015a
IXYX 25N250CV1HV		95	25	4.0	350	10.50	0.16	•	30	0.32	937	X015c
IXYX 40N250CHV		154	40	4.0	250	11.50	0.10				1500	X015c

X011c	TO-263ABHV	X014a	TO-247AD	X014c	TO-247HV	Outline drawings on pages O-36...O-59
X015a	PLUS247	X015c	PLUS247 HV	X019a	TO-268AAHV	
						X027a SOT-227B miniBLOC
X020a	TO-264	X022e	ISOPLUS264™	X024c	ISOPLUS i4-PAC™	

Discrete XPT™ / X2PT™ / NPT IGBT

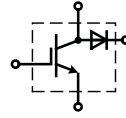

IXA...R...

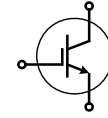

IXA...I... IXD...

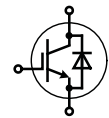

IXA...IF... IXD...D1

XPT™ IGBT XPT = Xtreme light Punch Through

Type	V _{CES}	I _{C25} IGBT	I _{C100} IGBT	V _{CEsat} typ IGBT	E _{off} IGBT	R _{thJC} IGBT	Diode	I _{F100} Diode	Fig. No.	Package style
➤ New ○ Not for new design ✧ under development	V	T _C = 25°C A	T _C = 100°C A	T _J = 25°C V	T _J = 125°C mJ	K/W		T _C = 100°C A		Outline drawings on pages O-36...O-59
1200 V XPT™ IGBT										
IXA 4IF1200UC	1200	9	5	1.8	0.25	2.70	•	6	X004	X004 TO-252AA
✧ IXA 4IF1200PZ		9	5	1.8	0.25	2.70	•	6	X011c	
IXA 4IF1200TC		9	5	1.8	0.25	2.70	•	6	X019	X005a TO-220AB
IXA 12IF1200HB		20	13	1.8	1.10	1.50	•	14	X014a	
IXA 12IF1200PB		20	13	1.8	1.10	1.50	•	14	X005a	X011c TO-263ABHV
○ IXA 12IF1200TC		20	13	1.8	1.10	1.50	•	14	X019	
IXA 17IF1200HJ		28	18	1.8	1.70	1.26	•	19	X016a	X014a TO-247AD
✧ IXA 20IF1200HR		33	19	1.8	1.70	0.95	•	22	X016c	
○ IXA 20IF1200HB		38	22	1.8	1.70	0.76	•	24	X014a	X016a ISOPLUS247™
IXA 20I1200PB		38	22	1.8	1.70	0.76	•	-	X005a	
IXA 20I1200PZ		38	22	1.8	1.70	0.76	•	-	X011c	X016a ISO247™
IXA 27IF1200HJ		43	24	1.8	3.00	0.84	•	25	X016a	
✧ IXA 30IF1200HR		48	27	1.8	3.00	0.70	•	30	X016c	X019 TO-268AA
IXA 33IF1200HB		58	34	1.8	3.00	0.50	•	33	X014a	
IXA 37IF1200HJ		58	33	1.8	4.10	0.64	•	25	X016a	X027a SOT-227B miniBLOC
✧ IXA 40IF1200HR		63	36	1.8	4.10	0.64	•	30	X016c	
IXA 45IF1200HB		78	45	1.8	4.10	0.38	•	33	X014a	
IXA 55I1200HJ		84	54	1.8	5.50	0.43	•	-	X016a	
IXA 60IF1200NA		88	56	1.8	5.50	0.43	•	51	X027a	
IXA 70I1200NA		100	65	1.8	5.50	0.35	•	-	X027a	
IXA 70R1200NA ¹⁾		100	65	1.8	5.50	0.35	•	55	X027a	
1200 V Fast Trench IGBT										
➤ ITF 48IF1200HR	1200	72	56 (90°C)	2.05	2.4 (150°C)	0.38	•	(90°C) 50	X016c	
1200 V X2PT™ IGBT										
➤ IXG 70IF1200NA	1200	130	86	1.8	5.3 (150°C)	0.38	•	71	X027a	

¹⁾ boost configuration

NPT IGBT NPT = Non Punch Through

1200 V NPT IGBT										
○ IXDH 20N120	1200	38	25 (90°C)	2.4	2.4	0.63		-	X014a	X027a SOT-227B miniBLOC
○ IXDH 20N120D1		38	25 (90°C)	2.4	2.4	0.63	•	(90°C) 19	X014a	
○ IXDH 30N120D1		60	38 (90°C)	2.4	3.4	0.42	•	(90°C) 35	X014a	
○ IXDR 30N120D1		50	30 (90°C)	2.4	3.4	0.60	•	(90°C) 27	X016a	
○ IXDN 55N120D1		100	62 (90°C)	2.3	6.2	0.28	•	(90°C) 60	X027a	
○ IXDN 75N120		150	95 (90°C)	2.2	10.5	0.19		-	X027a	

G-Series PT IGBTs

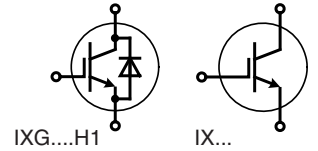

600 V, 1000 V and 1200 V IGBTs

Part Number	V _{CES} V	I _{C25} T _C = 25°C A	I _{C110} T _C = 110°C A	V _{CE(sat)} max. T _J = 25°C V	t _{fi} typ. T _J = 25°C ns	E _{off} typ. T _J = 125°C mJ	R _{thJC} max. K/W	Diode	I _{F110} Diode T _C = 110°C A	R _{thJC} max. Diode K/W	PC W	Fig. No.	Package style	Outline drawings on pages O-36...O-59	
A3 Class (up to 5kHz switching)													X005a	TO-220AB	
IXGH 36N60A3D4	600	75	36	1.40	325	5.30	0.56	•	-	2.50	220	X014a			
IXGH 48N60A3D1		75	48	1.35	224	5.60	0.42	•	-	0.90	300	X014a			
IXGH 72N60A3		75	72	1.35	250	6.50	0.23	-	-	-	540	X014a			
IXGK 72N60A3H1		75	72	1.35	250	6.50	0.23	•	-	0.30	540	X020a			
IXGR 72N60A3H1		75	72	1.35	250	6.50	0.62	•	-	0.80	200	X016a	X011b	TO-263AB	
IXGT 72N60A3		75	72	1.35	250	6.50	0.23	-	-	-	540	X019			
IXGX 72N60A3H1		75	72	1.35	250	6.50	0.23	•	-	0.30	540	X015a			
IXGH 56N60A3		150	56	1.35	315	6.75	0.38	-	-	-	330	X014a			
IXGN 72N60A3		160	68	1.35	250	6.50	0.35	-	-	-	360	X027a	X014a	TO-247AD	
IXGN 120N60A3		200	120	1.35	260	10.40	0.21	-	-	-	595	X027a			
IXGN 120N60A3D1		200	120	1.35	260	10.40	0.21	•	-	0.85	595	X027a			
IXGX 120N60A3		200	120	1.35	260	10.40	0.16	-	-	-	780	X015a			
IXGK 320N60A3		320	210	1.25	740	na	0.13	-	-	-	1000	X020a			
IXGN 320N60A3		320	170	1.25	740	na	0.17	-	-	-	735	X027a	X015a	PLUS247	
IXGX 320N60A3		320	210	1.25	740	na	0.13	-	-	-	1000	X015a			
IXGN 400N60A3		400	190	1.25	270	na	0.15	-	-	-	830	X027a			
IXGA 36N60A3		na	36	1.40	325	5.30	0.56	-	-	-	220	X011b			
IXGA 48N60A3		na	48	1.35	224	5.60	0.42	-	-	-	300	X011b			
IXGH 36N60A3		na	36	1.40	325	5.30	0.56	-	-	-	220	X014a			
IXGH 48N60A3		na	48	1.35	2.24	5.60	0.42	-	-	-	300	X014a	X016a	ISOPLUS247™	
IXGH 64N60A3		na	64	1.35	222	6.00	0.27	-	-	-	460	X014a			
IXGP 36N60A3		na	36	1.40	325	5.30	0.56	-	-	-	220	X005a			
IXGP 48N60A3		na	48	1.35	224	5.60	0.42	-	-	-	300	X005a			
IXGH 32N100A3	1000	75	32	2.20	540	13.00	0.42	-	-	-	300	X014a			
IXGT 32N100A3		75	32	2.20	540	13.00	0.42	-	-	-	300	X019	X019	TO-268AA	
IXGA 12N120A3	1200	22	na	3.00	1035	na	1.25	-	-	-	100	X011b			
IXGH 12N120A3		22	na	3.00	1035	na	1.25	-	-	-	100	X014a			
IXGP 12N120A3		22	na	3.00	1035	na	1.25	-	-	-	100	X005a			
IXGA 20N120A3		40	20	2.50	715	10.10	0.69	-	-	-	180	X011b			
IXGH 20N120A3		40	20	2.50	715	10.10	0.69	-	-	-	180	X014a	X020a	TO-264	
IXGP 20N120A3		40	20	2.50	715	10.10	0.69	-	-	-	180	X005a			
IXGR 55N120A3H1		70	30	2.35	282	29.00	0.62	•	-	0.42	200	X016a			
IXGH 32N120A3		75	na	2.35	1240	na	0.42	-	-	-	300	X014a			
IXGT 32N120A3		75	32	2.35	1240	na	0.42	-	-	-	300	X019			
IXGK 55N120A3H1		125	55	2.30	282	29.00	0.27	•	-	0.42	460	X020a	X027a	SOT-227B miniBLOC	
IXGX 55N120A3H1		125	55	2.30	282	29.00	0.27	•	-	0.42	460	X015a			
IXGK 120N120A3		240	120	2.20	325	58.00	0.15	-	-	-	830	X020a			
IXGX 120N120A3		240	120	2.20	325	58.00	0.15	-	-	-	830	X015a			
IXGK 82N120A3		260	82	2.05	780	22.50	0.10	-	-	-	1250	X020a			
IXGX 82N120A3		260	82	2.05	780	22.50	0.10	-	-	-	1250	X015a			

High Voltage NPT IGBTs

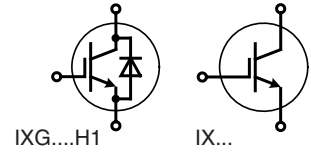

1700 V Low On-State Voltage NPT IGBTs

Part Type	V_{CES}	I_c	I_c	$V_{CE(sat)}$	E_{off}	R_{thJC}	Diode	Fig. No.	Package style	
➤ New	V	$T_c = 25^\circ C$ A	$T_c = 90^\circ C$ ($110^\circ C$) A	$T_c = 25^\circ C$ V	typ $T_J = 125^\circ C$ mJ	K/W			Outline drawings on pages O-36...O-59	
IXGH 6N170	1700	12	6	4.0	2.0	1.65		X014a	X014a TO-247AD	
IXGT 6N170		12	(6)	4.0	2.0	1.65		X019		
IXGH 10N170		20	10	4.0		1.10		X014a		
IXGT 10N170		20	10	4.0		1.10		X019		
IXGH 16N170		32	16	3.5	11.2	0.65		X014a		
IXGT 16N170		32	16	3.5	11.2	0.65		X019		
IXGF 32N170			44	-19	3.5	13.5	0.62		X024c	X015a PLUS247
IXGH 24N170			50	24	3.3	12.0	0.50		X014a	X016a ISOPLUS247™
IXGT 24N170			50	24	3.3	12.0	0.50		X019	
IXGH 32N170			75	32	3.3	14.0	0.35		X014a	X020a TO-264
IXGT 32N170			75	32	3.3	14.0	0.35		X019	
IXGN 100N170			160	95	3.0		0.17		X027a	
IXGX 100N170		170	100	3.0		0.15		X015a		
IXGK 100N170		170	100	3.0		0.15		X020a		
IXGN 200N170		280	160	2.6	44.0	0.10		X027a		

1700 V NPT IGBTs

Part Type	V_{CES}	I_c	I_c	$V_{CE(sat)}$	t_{fi}	E_{off}	R_{thJC}	Fig. No.	Package style
	V	$T_c = 25^\circ C$ A	$T_c = 90^\circ C$ ($110^\circ C$) A	$T_c = 25^\circ C$ V	typ $T_J = 25^\circ C$ ns	typ $T_J = 125^\circ C$ mJ	K/W		
IXGR 6N170A	1700	5.5	(2.5)	7	32	0.25	2.50	X016a	X024c ISOPLUS i4-PAC™
IXGH 6N170A		6	(3)	7	32	0.26	1.65	X014a	
IXGT 6N170A		6	(3)	7	32	0.26	1.65	X019	X027a SOT-227B miniBLOC
IXGH 10N170A		10	(5)	6	35	0.60	0.89	X014a	
IXGT 10N170A		10	5	6	35	0.60	0.89	X019	
IXGH 16N170A		16	11	5	70	2.00	0.65	X014a	
IXGT 16N170A		16	11	5	70	2.00	0.65	X019	
IXGH 24N170A		24	16	6	40	1.47	0.50	X014a	
IXGT 24N170A		24	16	6	40	1.47	0.50	X019	
IXGH 32N170A		32	21	5	50	2.40	0.35	X014a	
IXGT 32N170A		32	21	5	50	2.40	0.35	X019	

Very High Voltage NPT IGBTs

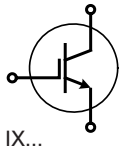

2.5 kV - 4.5 kV NPT IGBT

Part Type	V_{CES}	I_{C25} $T_C = 25^\circ C$	I_{C110} $T_C = [90^\circ C]$ $110^\circ C$ $(100^\circ C)$	$V_{CE(sat)}$ max. $T_C = 25^\circ C$	t_{fi} typ $T_J = 25^\circ C$	E_{off} typ $T_J = 125^\circ C$	R_{thJC} IGBT	P_c	Fig. No.	Package style
New	V	A	A	V	ns	mJ	K/W	W		Outline drawings on pages O-36...O-59
IXGF 20N250	2500	23	[14]	3.1	930	na	1.25	100	X024c	X011c TO-263ABHV
IXGA 20N250HV		30	12	3.1	930	na	0.83	150	X011c	
IXGF 25N250		30	15	2.9	200	na	1.10	114	X024c	
IXLF 19N250A		32	[19]	3.9	250	30	0.50	250	X024c	
IXGH 25N250		60	25	2.9	200	na	0.50	250	X014a	X014a TO-247AD
IXGT 25N250		60	25	2.9	200	na	0.50	250	X019	
IXGT 25N250HV		60	25	2.9	200	na	0.50	250	X019a	
IXGL 75N250		110	[65]	2.9	455	na	0.29	430	X022e	
IXGK 75N250		170	75	2.7	455	na	0.16	780	X020a	X015a PLUS247
IXGX 75N250		170	75	2.7	455	na	0.16	780	X015a	
IXG 65I3300KN	3300	85	(48)	2.8	900	52	0.34	368	X022e	
IXEL 40N400	4000	90	40	3.5	425	205	0.26	380	X022e	
IXG 50I4500KN	4500	74	(42)	3.2	1350	73	0.34	368	X022e	X014c TO-247HV
IXYF 30N450		23	17	3.9	1220	na	0.54	230	X024c	
IXYT 30N450HV		60	30	3.9	1220	na	0.29	430	X019a	
IXYF 40N450		60	32	3.9	1120	na	0.43	290	X024c	
IXYH 30N450HV		60	30	3.9	1220	na	0.29	430	X014c	X015a PLUS247
IXYL 60N450		90	38	3.3	1360	na	0.30	417	X022e	
IXYX 40N450HV		95	40	3.9	1120	na	0.19	660	X015c	

X019a **TO-268AAHV**

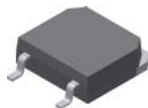

X019 **TO-268AA**



X015c **PLUS247HV**



X024c **ISOPLUS i4-PAC™**

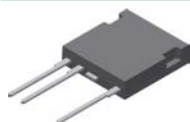

X022e **ISOPLUS264™**

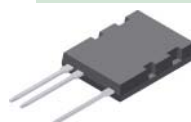



X020a **TO-264**

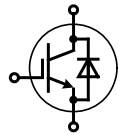

BiMOSFETs (Monolithic Bipolar MOS Transistors)

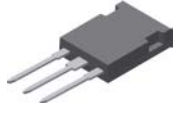

Reverse Conducting IGBTs (BiMOSFET™) 1.6 kV - 2.5 kV

Type	V_{CES}	I_{C25}	I_{C90}	$V_{CE(sat)}$ typ (max)	Q_G typ	t_f (t_{fi}) typ	R_{thJC} max.	Fig. No.	Package style Outline drawings on pages O-36...O-59	
	V	$T_c = 25^\circ C$ A	$T_c = 90^\circ C$ ($110^\circ C$) A	$T_c = 25^\circ C$ ($110^\circ C$) V	nC	ns	K/W			
IXBH 6N170	1700	12	6.0	2.84	17	600	1.65	X014a	X011c TO-263ABHV 	
IXBT 6N170		12	6.0	2.84	17	600	1.65	X019		
IXBA 16N170AHV		16	10	(6.00)	65	-150	0.83	X011c		
IXBH 16N170A		16	10	(6.00)	65	-150	0.83	X014a		
IXBT 16N170A		16	10	(6.00)	65	-150	0.83	X019		
IXBT 16N170AHV		16	10	(6.00)	65	-150	0.83	X019a		
IXBH 10N170		20	10	3.40	30	-150	0.89	X014a		
IXBT 10N170		20	10	3.40	30	-150	0.89	X019		
IXBN 42N170A		38	21	5.20	188	-82	0.40	X027a		X014a TO-247AD 
IXBH 16N170		40	16	(3.30)	72	705	0.50	X014a		
IXBT 16N170		40	16	(3.30)	72	705	0.50	X019		
IXBH 42N170A		42	21	5.20	188	-82	0.35	X014a		
IXBT 42N170A		42	21	5.20	188	-82	0.35	X019		
IXBR 42N170	57	32	(2.90)	188	740	0.62	X016a			
IXBH 24N170	60	(24)	(2.50)	140	960	0.50	X014a	X015a PLUS247 		
IXBT 24N170	60	(24)	(2.50)	140	960	0.50	X019			
IXBH 42N170	80	42	(2.80)	188	740	0.35	X014a			
IXBT 42N170	80	42	(2.80)	188	740	0.35	X019			
IXBX 75N170A	110	65	4.95	358	-175	0.12	X015a			
IXBN 75N170	145	75	2.60	350	580	0.20	X027a			
IXBK 75N170	200	(75)	2.60	350	580	0.12	X020a			
IXBX 75N170	200	(75)	2.60	350	580	0.12	X015a		X016a ISOPLUS247™ 	
IXCH 36N250	2500	73	(36)	2.60	177	900	0.21			X014a
IXCK 36N250		73	(36)	2.60	177	900	0.21			X020a
IXBL 64N250		116	(46)	2.50	400	175	0.25			X022e
IXBK 64N250		156	(64)	2.50	400	175	0.17			X020a
IXBX 64N250		156	(64)	2.50	400	175	0.17			X015a

X020a **TO-264**



X019a **TO-268AAHV**

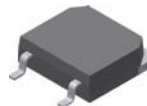

X019 **TO-268AA**

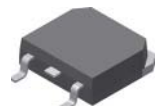

X022e **ISOPLUS264™**

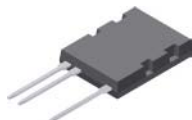





X027a **SOT-227B
miniBLOC**



BiMOSFETs (Monolithic Bipolar MOS Transistors)

Reverse Conducting IGBTs (BiMOSFET™) 3 kV - 3.6 kV

Type	V_{CES}	I_{C25} $T_C = 25^\circ\text{C}$	I_{C90} $T_C = 90^\circ\text{C}$ (110°C)	$V_{CE(sat)}$ typ $T_C = 25^\circ\text{C}$	Q_G typ	t_f (t_{fi}) typ $T_C = 125^\circ\text{C}$	R_{thJC} max.	Fig. No.	Package style
➤ New	V	A	A	V	nC	ns	K/W		Outline drawings on pages O-36...O-59
IXBF 14N300	3000	28	14	2.2	62	1730	1.04	X024c	X011c TO-263ABHV 
IXBH 10N300		30	(10)	2.8	45	1030	0.69	X014a	
IXBA 10N300HV		34	(10)	2.2	46	2010	0.69	X011c	
IXBH 10N300HV		34	(10)	2.2	46	2010	0.69	X014c	
IXBF 22N300		38	22	2.2	110	1650	0.83	X024c	
IXBA 14N300HV		38	(14)	2.2	62	1730	0.62	X011c	
IXBH 14N300HV		38	(14)	2.2	62	1730	0.62	X014c	
IXBF 32N300		40	22	2.8	142	630	0.78	X024c	
IXBF 28N300		50	28	2.3	110	3280	0.58	X024c	
IXBF 42N300		60	(24)	2.5	200	490	0.52	X024c	
IXBT 22N300HV		60	(22)	2.2	110	1650	0.43	X019a	X014a TO-247AD 
IXBH 22N300HV		60	(22)	2.2	110	1650	0.43	X014c	
IXBX 28N300HV		62	(28)	2.3	110	3280	0.36	X015c	
IXBH 32N300		80	(32)	2.8	142	630	0.31	X014a	
IXBH 32N300HV		80	(32)	2.8	142	630	0.31	X014c	
IXBT 32N300HV		80	(32)	2.8	142	630	0.31	X019a	
IXBF 55N300		86	(34)	2.7	335	260	0.35	X024c	
IXBH 42N300HV		104	(42)	2.5	200	490	0.25	X014c	X014c TO-247HV 
IXBT 42N300HV		104	(42)	2.5	200	490	0.25	X019a	
IXBK 55N300		130	(55)	2.7	335	260	0.20	X020a	
IXBX 55N300		130	(55)	2.7	335	260	0.20	X015a	
IXBF 16N360	3600	26	16	2.5	65	115	1.00	X024c	X015a PLUS247 
IXBF 20N360		45	(18)	2.9	110	1100	0.54	X024c	
IXBH 16N360HV		48	(16)	2.5	65	115	0.46	X014c	
IXBT 16N360HV		48	(16)	2.5	65	115	0.46	X019a	
IXBH 20N360HV		70	(20)	2.9	110	1100	0.29	X014c	
IXBT 20N360HV		70	(20)	2.9	110	1100	0.29	X019a	
IXBF 50N360		70	(28)	2.4	210	1670	0.43	X024c	
IXBL 60N360		92	(36)	2.8	450	1025	0.30	X022e	
IXBX 50N360HV		125	(50)	2.4	210	1670	0.19	X015c	

X020a

TO-264



X019a

TO-268AAHV

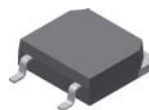

X015c

PLUS247HV



X024c

ISOPLUS i4-PAC™

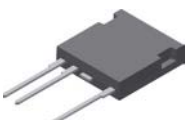

X022e

ISOPLUS264™



IGBT Modules – CBI Configuration

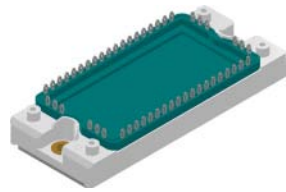

X112a E2-Pack PFP

Outline drawings on pages O-36...O-59

See data sheet for pin arrangement

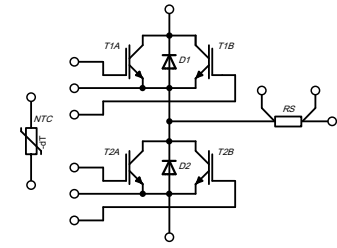

Phase Leg IGBT Module

Type	V_{CES}	I_{C80} IGBT $T_C = 80^\circ\text{C}$	$V_{CE(sat)}$ typ IGBT $T_J = 25^\circ\text{C}$	E_{on} IGBT $T_J = 150^\circ\text{C}$	E_{off} IGBT $T_J = 150^\circ\text{C}$	R_{thJC} IGBT	I_{F80} Diode $T_C = 80^\circ\text{C}$	R_{thJC} Diode
➤ New	V	A	V	mJ	mJ	K/W	A	K/W
1200 V X2PT™ IGBT with shunt								
➤ MIXG 360PF1200PSTED ¹⁾	1200	420 ³⁾	1.7	32	32	0.08	340	0.13
➤ MIXG 360PF1200PSTED-PC ^{1) 2)}		420 ³⁾	1.7	32	32	0.08	340	0.13

¹⁾ Press fit pin version ²⁾ phase change material (PCM)

³⁾ Rating correlates to parallel operation of T1A@T1B (resp. T2A@T2B)

Outline drawings on pages O-36...O-59

See data sheet for pin arrangement

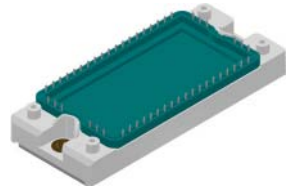

X112 E2-Pack

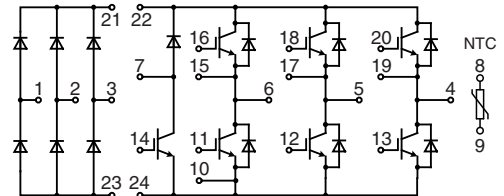

CBI 2 IGBT Modules

Type	Rectifier 3~			Inverter 3~					Brake chopper			Layout
	V_{RRM}	I_{DAVM} $T_C = 80^\circ\text{C}$	R_{thJC} typ.	V_{CES}	I_C $T_C = 25^\circ\text{C}$	I_C $T_C = 80^\circ\text{C}$	$V_{CE(sat)}$ typ.	R_{thJC} typ.	V_{CES}	I_C $T_C = 80^\circ\text{C}$	R_{thJC} typ.	
○ Not for new design	V	A	K/W	V	A	A	V	K/W	V	A	K/W	
1200 V NPT IGBT												
○ MUBW 15-12A7	1600	24	1.3	600	35	25	2.0	0.70	600	15	1.2	A
○ MUBW 25-12A7		24	1.3		50	35	2.2	0.55		15	1.2	A
○ MUBW 35-12A7		29	1.1		50	35	2.5	0.55		25	0.7	A
1200 V XPT IGBT												
MIXA 10WB1200TED	1600	105	1.1	1200	17	12	1.8	2.00	1200	12	2.0	A
MIXA 20WB1200TED		105	1.1		28	20	1.8	1.26		12	2.0	A
MIXA 30WB1200TED		105	1.1		43	30	1.8	0.84		12	2.0	A
MIXA 40WB1200TED		105	1.1		50	40	1.8	0.64		20	1.26	A

IGBT Modules – CBI Configuration

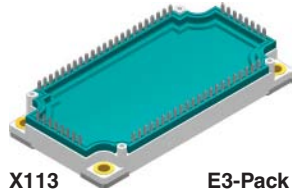

Outline drawings on pages O-36...O-59

See data sheet for pin arrangement

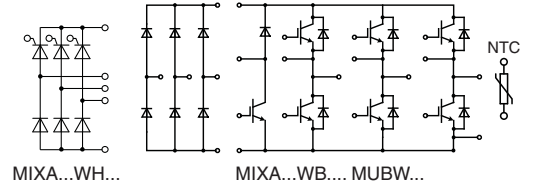

CBI 3 IGBT Modules

X113

E3-Pack

Type	Rectifier 3~			Inverter 3~					Brake chopper			Layout
	V_{RRM}	I_{DAVM} $T_H = 80^\circ\text{C}$	R_{thJC} typ.	V_{CES}	I_C $T_C = 25^\circ\text{C}$	I_C $T_C = 80^\circ\text{C}$	$V_{CE(sat)}$ typ.	R_{thJC} typ.	V_{CES}	I_C $T_C = 80^\circ\text{C}$	R_{thJC} typ.	
▶ New ○ Not for new design ◇ under development	V	A	K/W	V	A	A	V	K/W	V	A	K/W	
1200 V NPT IGBT												
○ MUBW 50-12A8	1600	46	0.94	1200	85	60	2.2	0.35	1200	35	0.55	A
1200 V Trench IGBT												
○ MUBW 75-12T8	1600	50	0.94	1200	105	75	1.7	0.35	1200	35	0.55	A
1200 V XPT™ IGBT												
MIXA 60WB1200TEH	1600	190	0.65	1200	85	60	1.8	0.43	1200	40	0.64	A
MIXA 60WH1200TEH ¹⁾		135	0.65		85	60	1.8	0.43		40	0.64	C
MIXA 80WB1200TEH		265	0.50		120	84	1.8	0.32		40	0.64	A
◇ MIXA 81WB1200TEH		290	0.45		120	84	1.8	0.32		60	0.43	B
1700 V Trench IGBT												
MUBW 50-17T8	2200	130	1.10	1700	74	53	2.0	0.49	1700	34	0.62	A
▶ MUBW 50-17T8-PFPC ²⁾		130	1.10		74	53	2.0	0.49		34	0.62	A
MUBW 75-17T8		155	0.95		113	80	2.0	0.28		34	0.62	A
▶ MUBW 75-17T8-PFPC ²⁾		155	0.95		113	80	2.0	0.28		34	0.62	A

¹⁾ Input rectifier half-controlled; ²⁾ with press fit pins and pre applied phase change material

Options: press fit pin version and phase change material; please contact IXYS sales office for availability.

Layout A

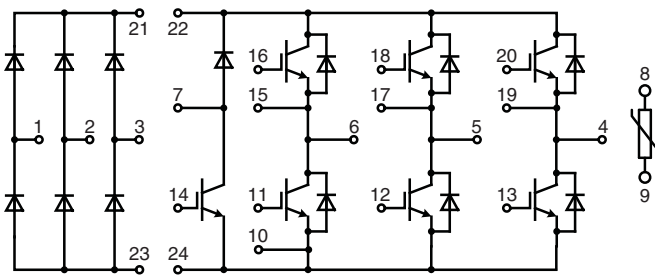

Layout B

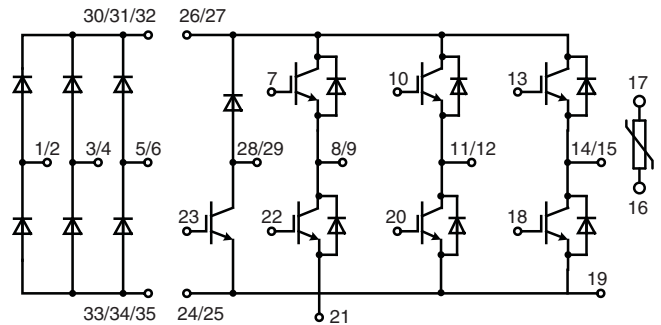

Layout C

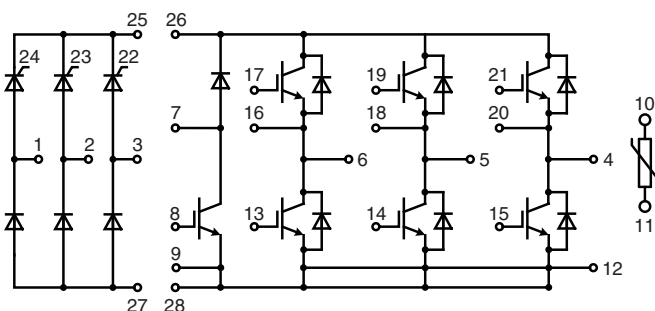

IGBT Modules – Six-Pack configuration

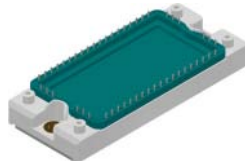

Outline drawings on pages O-36...O-59

See data sheet for pin arrangement

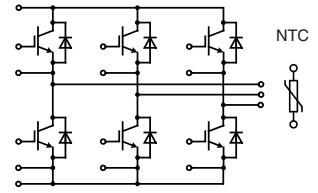

Six-Pack IGBT Modules

X112

E2-Pack

Type	V_{CES}	I_{C25} IGBT $T_C = 25^\circ C$	I_{C80} IGBT $T_C = 80^\circ C$	$V_{CE(sat)}$ typ IGBT $T_J = 25^\circ C$	E_{off} IGBT $T_J = 125^\circ C$	R_{thJC} IGBT	I_{F25} Diode $T_C = 25^\circ C$	I_{F80} Diode $T_C = 80^\circ C$	NTC	Layout
1200 V NPT IGBT										
○ MWI 15-12A7	1200	30	20	1.0	1.8	0.88	25	17		A
○ MWI 25-12A7		50	35	2.2	2.8	0.55	50	33		A
1200 V XPT™ IGBT										
○ MIXA 30W1200TED ¹⁾	1200	43	30	1.8	3.0	0.84	44	29	•	B
○ MIXA 40W1200TED ¹⁾		60	40	1.8	4.1	0.64	44	29	•	B
➤ MIXA 41W1200ED ¹⁾		60	40	1.8	4.1	0.64	44	29		A
○ MIXA 60W1200TED ¹⁾		85	60	1.8	5.5	0.43	88	59	•	B
○ MIXA 80W1200TED ¹⁾		120	84	1.8	8.3	0.32	135	90	•	B
1200 V X2PT™ IGBT										
➤ MIXG 70W1200TED ¹⁾	1200	105	79	1.7	5.3 (150°C)	0.42	88	59	•	B
1200 V Trench IGBT										
○ MWI 50-12T7T	1200	75	50	1.7	6.5	0.49	110	70	•	B
○ MWI 75-12T7T		105	75	1.7	9.5	0.35	150	100	•	B

¹⁾ Options: press fit pin version and phase change material; please contact IXYS sales office for availability

Layout A

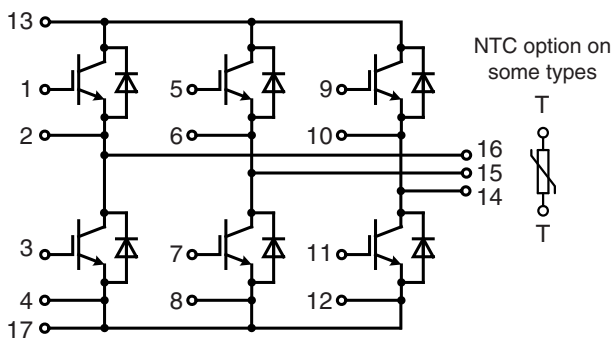

Layout B

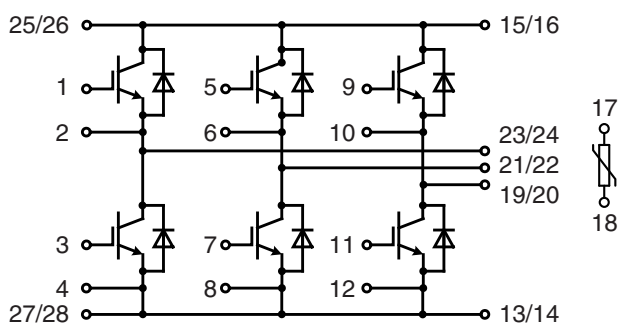

Layout C

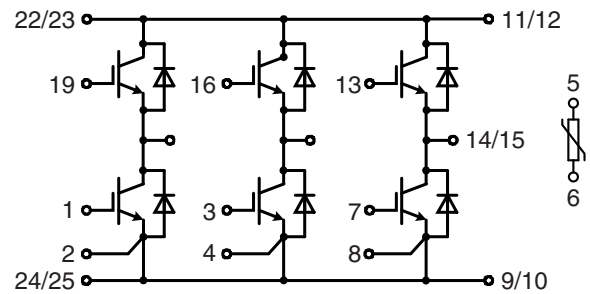

IGBT Modules – Six-Pack configuration

X113/X113a

E3-Pack/PFP

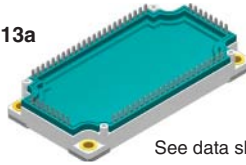

See data sheet for pin arrangement

Six-Pack IGBT Modules

Package style
Outline drawings
on pages O-36...O-59

Type	V_{CES}	I_{C25} IGBT $T_C = 25^\circ\text{C}$	I_{C80} IGBT $T_C = 80^\circ\text{C}$	$V_{CE(sat)}$ typ IGBT $T_J = 25^\circ\text{C}$	E_{off} IGBT $T_J = 125^\circ\text{C}$	R_{thJC} IGBT	I_{F25} Diode $T_C = 25^\circ\text{C}$	I_{F80} Diode $T_C = 80^\circ\text{C}$	NTC	Layout
1200 V NPT IGBT										
○ MWI 100-12A8		160	110	2.2	14.6	0.19	200	130		A
1200 V SPT+ IGBT										
○ MIEB 100W1200DPFTEH	1200	183	128	1.8	9.7	0.20	135	90	•	B
○ MIEB 101W1200EH		183	128	1.8	9.7	0.20	135	90		A
1200 V XPT™ IGBT										
MIXA 80W1200TEH ¹⁾	1200	120	84	1.8	8.3	0.32	135	90	•	B
MIXA 100W1200TEH ¹⁾		155	108	1.8	11.0	0.25	135	90	•	B
MIXA 150W1200TEH ¹⁾		220	150	1.8	16.0	0.18	190	130	•	B
1200 V X2PT™										
MIXG 120W1200DPFTEH ¹⁾	1200	185	140	1.7	8.2 (150°C)	0.30	199	127	•	B
MIXG 120W1200TEH ¹⁾		185	140	1.7	8.2 (150°C)	0.30	180	135	•	B
➤ MIXG 120W1200PTEH ²⁾		185	140	1.7	8.2 (150°C)	0.30	180	135	•	B
◇ MIXG 120W1200PTEH-PC ²⁾³⁾		185	140	1.7	8.2 (150°C)	0.30	180	135	•	B
MIXG 180W1200TEH ¹⁾		260	195	1.7	14.7 (150°C)	0.18	230	170	•	B
➤ MIXG 180W1200PTEH ²⁾		260	195	1.7	14.7 (150°C)	0.18	230	170	•	B
➤ MIXG 180W1200PTEH-PC ²⁾³⁾		260	195	1.7	14.7 (150°C)	0.18	230	170	•	B
MIXG 240W1200TEH ¹⁾		312	233	1.7	20.5 (150°C)	0.16	200	144	•	B
◇ MIXG 240W1200PTEH ²⁾		312	233	1.7	20.5 (150°C)	0.16	200	144	•	B
◇ MIXG 240W1200PTEH-PC ²⁾³⁾		312	233	1.7	20.5 (150°C)	0.16	200	144	•	B
1200 V X2PT™ with Shunt Resistor										
◇ MIXG 120W1200STEH ¹⁾	1200	185	140	1.7	8.2 (150°C)	0.24	180	135	•	C
◇ MIXG 180W1200STEH ¹⁾		260	195	1.7	14.7 (150°C)	0.18	230	170	•	C
◇ MIXG 240W1200ZTEH ¹⁾		312	233	1.7	20.5 (150°C)	0.16	189	136	•	C
➤ MIXG 240W1200PZTEH ²⁾		312	233	1.7	20.5 (150°C)	0.16	189	136	•	C
MIXG 240W1200PZTEH-PC ²⁾³⁾		312	233	1.7	20.5 (150°C)	0.16	189	136	•	C

¹⁾ Options: press fit pin version and / or phase change material; please contact IXYS sales office for availability

²⁾ press fit pin version ³⁾ phase change material (PCM)

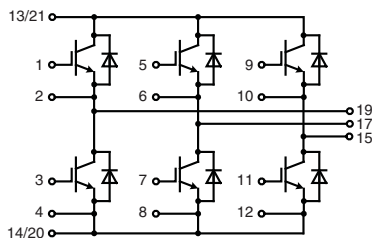

Layout A

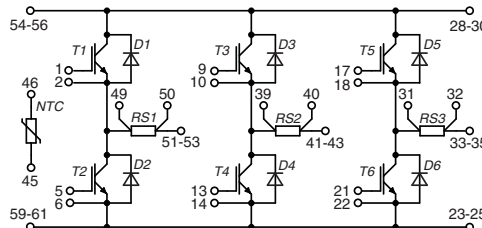

Layout C

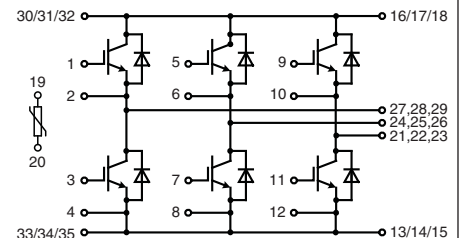

Layout B

IGBT XPT™ Modules in SimBus F package

- space savings
- reduced protection circuits
- package designed for wave soldering
- press fit pin version available

See data sheet for pin arrangement

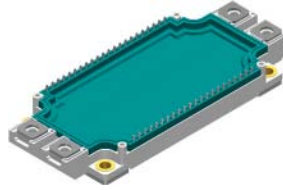

X143

Simbus F

Package style

Outline drawings
on pages O-36...O-59

Type	V _{CES}	I _{C80} IGBT	V _{CE(sat)} typ IGBT	E _{on} IGBT	E _{off} IGBT	R _{thJC} IGBT	I _{F80} Diode	R _{thJC} Diode
▶ New ✦ under development	V	T _C = 80°C A	T _J = 25°C V	T _J = 125°C mJ	T _J = 125°C mJ	K/W	T _C = 80°C A	K/W
XPT™ / X2PT™ IGBT Phase-Leg								
MIXA 225PF1200TSF	1200	250	1.80	20	27	0.115	185	0.145
MIXA 300PF1200TSF		325	1.80	20	42	0.085	185	0.145
MIXA 450PF1200TSF		450	1.80	22	68	0.060	265	0.095
MIXG 300PF1700TSF	1700	315	2.10	60	69	0.078	205	0.180
MIXG 450PF1700TSF		435	2.10	110	108	0.061	330	0.110
XPT™ / X2PT™ IGBT Brake / Boost								
▶ MIXA 225RF1200TSF	1200	250	1.80	20	27	0.115	185	0.145
✦ MIXG 450RF1700TSF	1700	435	2.10	110	108	0.061	330	0.110

Options: press fit pin version and phase change material; please contact IXYS sales office for availability

...PF...
phase-leg

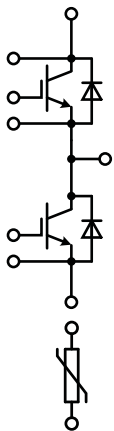

...PF...
phase-leg & shunt

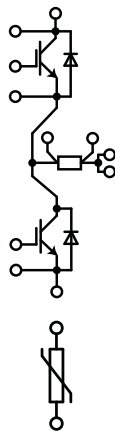

...RF...
brake / boost

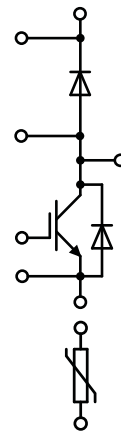

IGBT Full Bridge and Brake / Buck Modules

Outline drawings on pages O-36...O-59

See data sheet for pin arrangement

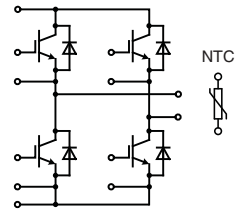
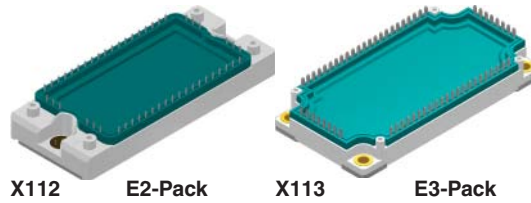

Full Bridge IGBT Modules

Type	Technology	V _{CES} V	I _{C25} IGBT T _C = 25°C A	I _{C80} IGBT T _C = 80°C A	V _{CE(sat)} typ IGBT T _J = 25°C V	E _{off} IGBT T _J = 125°C mJ	I _{F80} Diode T _C = 80°C A	NTC	Fig. No.
○ Not for new design									
○ MKI 50-12F7	Fast NPT ¹⁾	1200	65	45	3.2	2.5	70		X112
○ MKI 100-12F8			65	45	3.2	2.5	70		X113
○ MIXA 61H1200ED	XPT	1200	85	60	1.8	5.5	59		X112
○ MIXA 81H1200EH			120	84	1.8	8.3	90		X113

Brake / Buck / Boost Chopper IGBT Modules

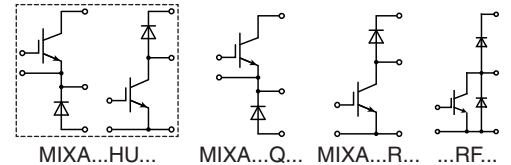

Type	V _{CES} V	I _{C25} IGBT T _C = 25°C A	I _{C80} IGBT T _C = 80°C A	V _{CE(sat)} typ IGBT T _J = 25°C V	E _{off} IGBT T _J = 125°C mJ	R _{thJC} IGBT K/W	I _{F25} Diode T _C = 25°C A	I _{F80} Diode T _C = 80°C A	Fig. No.
X2PT™ IGBT Brake									
◇ MIXG 240RF1200TED ¹⁾	1200	335	250	1.7	23 (150°C)	0.12	265	195	X112
➤ MIXG 240RF1200PTED ²⁾		335	250	1.7	23 (150°C)	0.12	265	195	X112a
➤ MIXG 240RF1200PTED-PC ²⁾³⁾		335	250	1.7	23 (150°C)	0.12	265	195	
➤ MIXG 360RF1200TED ¹⁾		532	400	1.7	30 (150°C)	0.08	390	285	X112
MIXG 360RF1200PTED-PC ²⁾³⁾	532	400	1.7	30 (150°C)	0.08	390	285	X112a	
Trench IGBT Brake									
➤ MITA 300RF1700PTED ²⁾	1700	450	310	1.7	34	0.09	390	285	X112a
➤ MITA 300RF1700PTED-PC ²⁾³⁾		450	310	1.7	34	0.09	390	285	
XPT™ IGBT Brake / Boost Chopper									
MIXA 80R1200VA	1200	120	84	1.9	8.3	0.32	135	90	X103
MIXA 150R1200VA		220	150	1.8	16	0.18	190	130	
XPT™ IGBT Buck Chopper									
MIXA 150Q1200VA	1200	220	150	1.8	16	0.18	190	130	X103
XPT™ IGBT Buck / Boost switched reluctance Chopper									
MIXA 60HU1200VA	1200	85	60	1.8	5.5	0.43	88	59	X103

¹⁾ Options: press fit pin version and / or phase change material; please contact IXYS sales office for availability

²⁾ press fit pin version ³⁾ phase change material (PCM)

See data sheet for pin arrangements



X103 V1-Pack

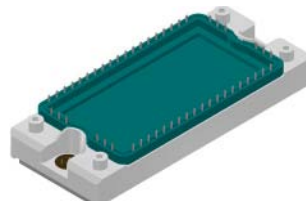

X112 E2-Pack

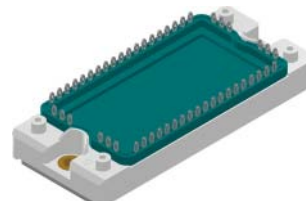

X112a E2-Pack PFP

Outline drawings on pages O-36...O-59

IGBT Half Bridge Modules

Outline drawings on pages O-36...O-59

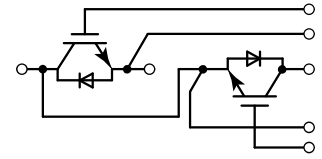
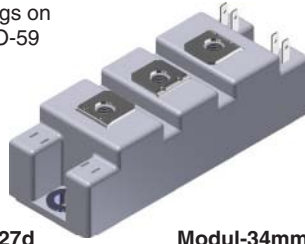

34 mm Package

X127d Modul-34mm

Type	V_{CES}	I_{C25} IGBT $T_C = 25^\circ\text{C}$	I_C IGBT	@ T_C °C	$V_{CE(sat)}$ typ IGBT $T_J = 25^\circ\text{C}$	E_{off} IGBT $T_J = 125^\circ\text{C}$	V_F typ Diode $T_J = 25^\circ\text{C}$	R_{thJC} Diode	Fig. No.
➤ New	V	A	A		V	mJ	V	K/W	
➤ MG0675S-BN4MM	600	100	75	70	1.45	2.40	1.55	0.90	X127d
➤ MG06100S-BN4MM		125	100	70	1.45	3.35	1.55	0.75	
➤ MG06150S-BN4MM		225	150	60	1.45	5.30	1.55	0.50	
➤ MG06200S-BN4MM		300	200	60	1.45	6.90	1.55	0.45	
➤ MG12100S-BN2MM	1200	140	100	80	1.70	10.00	1.65	0.50	
➤ MG12150S-BN2MM		200	150	80	1.70	14.50	1.65	0.36	
➤ MG1750S-BN4MM	1700	75	50	80	2.00	15.50	1.80	0.55	
➤ MG1775S-BN4MM		125	75	80	2.00	23.50	1.80	0.45	
➤ MG17100S-BN4MM		150	100	80	2.00	32.50	1.80	0.36	

Outline drawings on pages O-36...O-59

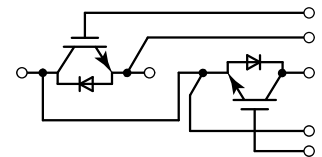
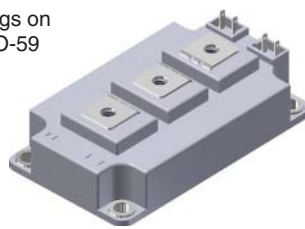

62 mm Package

X128e Modul-62mm

➤ MG06300D-BN4MM	600	400	300	70	1.45	12	1.55	0.32	X128e
➤ MG06400D-BN4MM		500	400	70	1.45	15	1.55	0.22	
➤ MG12200D-BN2MM	1200	290	200	80	1.70	25	1.65	0.20	
➤ MG12300D-BN2MM		480	300	80	1.70	37	1.65	0.15	
➤ MG12400D-BN2MM		580	400	80	1.70	50	1.65	0.12	
➤ MG17100D-BN4MM	1700	150	100	80	2.00	31	1.80	0.26	
➤ MG17150D-BN4MM		250	150	80	2.00	47	1.80	0.21	
➤ MG17200D-BN4MM		300	200	80	2.00	63	1.80	0.16	
➤ MG17300D-BN4MM		400	300	80	2.00	94	1.80	0.13	

Power MOSFETs and MOSFET Modules

The Metal Oxide Semiconductor Field Effect Transistor (MOSFET) is a transistor that is used for high frequency switching control of power electronic systems. IXYS offer various MOSFET technology based on the customer requirement for voltage, switching frequency. A table giving a diagrammatic representation of our basic MOSFET offerings is given below.

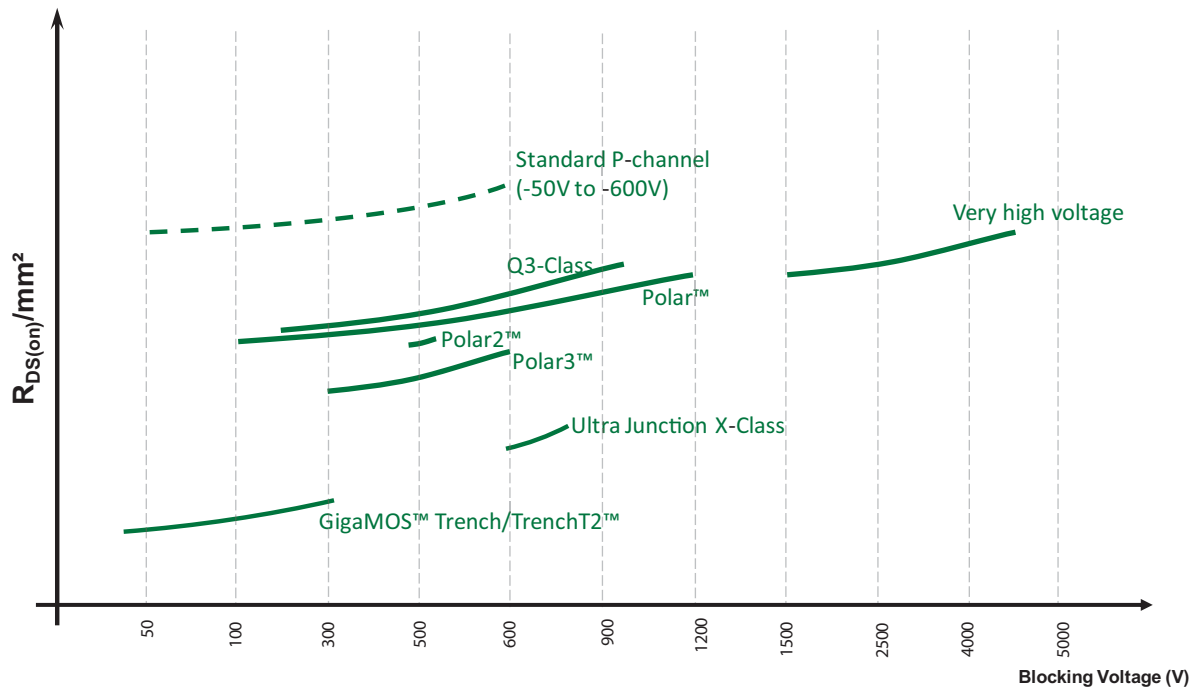

Trench and Trench2 Power MOSFETs

IXYS Trench Power MOSFETs are ideally suited for low-voltage, high-current applications. These MOSFETs feature an exceptionally low $R_{DS(on)}$, thus guaranteeing low power dissipation. Trench HiPerFET™ versions feature all of the advantages presented by IXYS' Trench Standard Power MOSFETs with an added benefit of a fast intrinsic rectifier which provides low reverse recovery charge (Q_{rr}) and excellent commutating dV/dt ratings for enhanced power switching capabilities and device ruggedness.

Polar™ Power MOSFETs

Polar™ MOSFETs (IXT..) feature a proprietary cell design and process that has resulted in a MOSFET with a 30% reduction in $R_{DS(on)}$ per unit area along with a decrease in gate charge. IXYS has also reduced the wafer thickness, which substantially reduces the thermal resistance. The combination of lower $R_{DS(on)}$, lower gate charge Q_g and higher power dissipation capability has resulted in a new class of MOSFETs, which will increase the cost effectiveness in switch mode power supply (SMPS) applications. IXYS' Polar™ HiPerFETs™ (IXF..) combine the strengths of the Polar Standard product family with a faster body diode, whose reverse recovery time (t_{rr}) is reduced to make them suitable for phase-shift bridges, motor control and uninterruptible power supply applications (UPS). This family of HiPerFETs™ provide lowest $R_{DS(on)}$, low R_{thJC} , low Q_g , and enhanced DV/DT capability.

PolarP2™ Power MOSFETs

PolarP2™ devices are an optimized range of the standard Polar platform for 500V device rating.

PolarP3™ HiPerFET™ Power MOSFETs

The PolarP3™ HiPerFET™ product family is the latest addition to IXYS' benchmark high-performance Polar-Series product line for our product portfolio between 500V and 600V. Its high Figure of Merit (FOM) being the multiplication of Q_g and in $R_{DS(on)}$ provide an excellent alternative to weaker super junction technologies. All IXYS Polar MOSFETs are tested 100% for avalanche energy providing the industries standard for reliability and ruggedness.

X-Class Power MOSFETs

These devices are developed using a charge compensation principle and proprietary process technology, resulting in Power MOSFETs with significantly reduced resistance $R_{DS(on)}$ and gate charge Q_g . They also exhibit a superior dv/dt performance. Designed for such applications as switched-mode and resonant-mode power supplies, DC-DC converters, PFC circuits, AC and DC motor drives, and robotic and servo control, these MOSFETs enable higher efficiency, along with high power density and cooler system performance. The X2-Class Power MOSFETs, devices with fast body diodes and avalanche ratings, are also available.

Q3-Class HiPerFET™ MOSFETs

Q3-Class HiPerFET™ MOSFETs (Identified by the suffix letter Q3) is the direct result of a revolutionary new chip design, which decreases the MOSFETs total gate charge (Q_g) and the Miller capacitance (C_{rss}), while maintaining the ruggedness and fast switching intrinsic diode of the company's current HiPerFET™ product line. The result is a MOSFET with dramatically improved switching efficiencies and thus enabling higher frequency operation and smaller power supplies.

Power MOSFETs and MOSFET Modules

Extended FBSOA Linear Power MOSFETs

IXYS' Extended FBSOA Linear Power MOSFETs are a class of rugged Power MOSFETs tailored specifically for applications that require Power MOSFETs to operate in their current saturation region. These new devices feature low static drain to source on-resistances and provide unparalleled performance and reliability in controlled current output applications. Typical applications that stand to benefit from this new class of extended FBSOA power MOSFETs include circuit breakers, current sources, programmable loads, power controllers, power regulators, motor control, power amplifiers and soft start applications. In the linear mode, a power MOSFET is subjected to high thermo-electrical stress caused by the simultaneous occurrence of high drain voltage and current resulting in high power dissipation. IXYS has optimized the internal structure of these MOSFETs achieving an extended "forward bias safe operating area" (FBSOA) capability to overcome the limitations posed by conventional power MOSFETs operating in current saturation region. These extended FBSOA Power MOSFETs are not intended for high speed switching applications.

Depletion-Mode MOSFET

Depletion-Mode Power MOSFETs operate in a 'normally-on' mode, not requiring energy or gate voltage for turn on. Unlike the regular enhancement type MOSFETs these Depletion-Mode MOSFETs require a negative gate bias to turn off. Consequently they remain on at or above zero gate bias voltage but otherwise have similar MOSFET characteristics. The "normally-on" operational mode of these devices combined with an enhanced linear operating capability allows for an ideal device selection in current sources, current regulators, solid-state relays, level shifting, active loads, start-up circuits and active power filters. Since these devices require no energy or gate voltage for turn-on, high energy efficiency can be achieved through device implementation in zero power "normally on" load switch applications. With the high degree of current regulation, these devices can also act as active inductors with high dynamic impedance in power filter applications to limit voltage and current noise and spikes. Furthermore these devices can provide active circuit protection to limit the surge of current during short-circuit or overload conditions.

PolarP™ P-Channel Power MOSFETs

IXYS' Polar technology platform employed in our PolarP™ P-Channel MOSFETs utilizes a proprietary cell design that improves overall device efficiency and performance. This technology platform reduces on-state resistance by as much as 30% and gate charge by 40% compared to legacy counterparts. With such low onstate resistances, these devices offer low conduction and switching losses while a low input capacitance. The combination of low $R_{DS(on)}$ and gate charge allow for improved energy efficiency. These P-Channel MOSFETs are dynamic dV/dt and avalanche rated making them extremely rugged in demanding operating environments and can easily be paralleled due to an on-state resistance with a positive temperature coefficient. They are ideal for 'high side' switching where a simple drive circuit referenced to ground can be used, circumventing additional 'high side' driver circuitry commonly involved when using an N-Channel MOSFET. This will help designers to reduce component count and improve reliability. Furthermore it allows for the design of a complementary power output stage. with a corresponding IXYS N-Channel MOSFET. for a power half bridge stage with a simple drive circuit.

TrenchP™ P-Channel Power MOSFETs





This family of P-Channel devices benefit from technological advances derived from IXYS' robust Trench cell design commonly implemented in their wide portfolio of industry recognized power devices. They feature an ultra low $R_{DS(on)}$, minimizing conduction losses and promoting improved operating and thermal efficiencies. These TrenchP™ P-Channel MOSFETs are suitable for 'high side' switching where a simple drive circuit referenced to ground can be employed, circumventing additional 'high side' driver circuitry commonly involved when using an N-Channel MOSFET. This enables designers to reduce component count, thereby improving drive circuit simplicity and cost structure. Furthermore it allows for the design of a complementary power output stage, with a corresponding IXYS N-Channel MOSFET, for a power half bridge stage with a simple drive circuit. Common applications that will greatly benefit from these devices include high side switching, high current regulators, DC Choppers, CMOS high power amplifiers, push-pull amplifiers and power solid state relays.

Very High Voltage Power MOSFETs

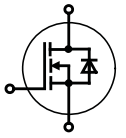
IXYS' VHV N-Channel Power MOSFETs are specifically designed to address demanding, fast-switching applications requiring blocking capabilities of 2.5kV to 4.5kV. These VHV Power MOSFETs are also ideally suited for parallel operation due to the positive temperature coefficient of their on-state resistance. Parallel operation with these devices provides a more cost-effective solution than employing series-connected, lower-voltage MOSFETs. The reduction or replacement of multiple series-connected devices and the associated gate drive circuitry commonly involved, simplifies design, improves reliability and reduces over-all system cost. These VHV MOSFETs represent an optimal solution in applications such as laser and x-ray generation systems, high-voltage power supplies, pulse circuits, high voltage automated test equipment and capacitor discharge circuits. 4.5kV device offerings feature high isolation capability with superior thermal performance.

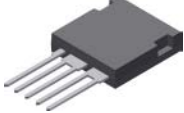

Trench Power MOSFETs



Part Type	V _{DSS} V	I _{D(cont)} ^{Chip} T _C = 25°C A	R _{DS(on)} T _J = 25°C Ω	C _{iss} typ. ns	Q _g typ. ns	t _{rr} typ. ns	R _{thJC} K/W	P _D W	Fig. No.	Package style Outline drawings on pages O-36...O-59	
IXTP 44N10T	100	44	0.0300	1567	27.4	60	1.15	130	X005a	X004 TO-252AA 	
IXTY 44N10T		44	0.0300	1567	27.4	60	1.15	130	X004		
IXTP 60N10T		60	0.0180	2650	49	59	0.85	176	X005a		
IXTA 60N10T		60	0.0180	2650	49	59	0.85	176	X011b		
IXTQ 60N10T		60	0.0180	2650	49	59	0.85	176	X017a		
IXTP 80N10T		80	0.0140	3040	60	100	0.65	230	X005a		
IXTF 200N10T	100	90	0.0070	9400	152	76	0.96	156	X024d	X005a TO-220AB 	
IXTL 2x180N10T		100	0.0074	6900	151	60	1.00	150	X022c		
IXTP 130N10T	200	130	0.0091	5080	104	67	0.42	360	X005a	X011b TO-263AB 	
IXTH 130N10T		130	0.0091	5080	104	67	0.42	360	X014a		
IXTA 130N10T		130	0.0091	5080	104	67	0.42	360	X011b		
IXTQ 130N10T		130	0.0091	5080	104	67	0.42	360	X017a		
IXTP 180N10T		180	0.0064	6900	151	72	0.31	480	X005a		
IXTH 180N10T		180	0.0064	6900	151	100	0.31	480	X014a		
IXTA 180N10T		180	0.0064	6900	151	72	0.31	480	X011b		
IXTQ 180N10T		180	0.0064	6900	151	100	0.31	480	X017a		
IXTN 200N10T		200	0.0055	9400	152	76	0.30	550	X027a		
IXTH 200N10T		200	0.0055	9400	152	76	0.27	550	X014a		
IXTQ 200N10T		200	0.0055	9400	152	76	0.27	550	X017a		
IXTP 48N20T		200	48	0.0500	3090	60	130	0.50	250		X005a
IXTA 48N20T	48		0.0500	3090	60	130	0.50	250	X011b		
IXTQ 48N20T	48		0.0500	3090	60	130	0.50	250	X017a		
IXTP 60N20T	60		0.0400	4530	73	118	0.30	500	X005a		
IXTA 60N20T	60		0.0400	4530	73	118	0.30	500	X011b		
IXTQ 60N20T	60		0.0400	4530	73	118	0.30	500	X017a		
IXTP 86N20T	86		0.0290	4500	90	140	0.31	480	X005a		
IXTA 86N20T	86		0.0290	4500	90	140	0.31	480	X011b		
IXTQ 86N20T	86		0.0290	4500	90	140	0.31	480	X017a		
IXTH 130N20T	130		0.0160	8800	150	150	0.18	830	X014a		
IXTP 50N25T	250	50	0.0600	4000	78	166	0.31	400	X005a	X024d ISOPLUS i4-PAC™ 	
IXTH 50N25T		50	0.0600	4000	78	166	0.31	400	X014a		
IXTA 50N25T		50	0.0600	4000	78	166	0.31	400	X011b		
IXTQ 50N25T		50	0.0600	4000	78	166	0.31	400	X017a		
IXTP 76N25T		76	0.0390	4920	92	148	0.27	460	X005a		
IXTH 76N25T		76	0.0390	4920	92	148	0.27	460	X014a		
IXTA 76N25T		76	0.0390	4920	92	148	0.27	460	X011b		
IXTQ 76N25T		76	0.0390	4920	92	148	0.27	460	X017a		
IXTH 86N25T		86	0.0370	5330	105	156	0.23	540	X014a		
IXTQ 86N25T		86	0.0370	5330	105	156	0.23	540	X017a		
IXTH 96N25T		96	0.0290	6100	114	158	0.20	625	X014a		
IXTQ 96N25T		96	0.0290	6100	114	158	0.20	625	X017a		
IXTH 110N25T		110	0.0240	9400	157	170	0.18	694	X014a		
											X027a SOT-227B miniBLOC 

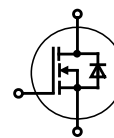



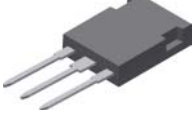
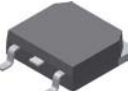

Trench HiPerFET™ MOSFETs with Fast Intrinsic Diode

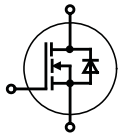

Part Type	V _{DSS} V	I _{D(cont)} Chip T _C = 25°C A	R _{DS(on)} T _C = 25°C Ω	C _{iss} typ. pF	Q _g typ. nC	t _{rr} max. (typ.) ns	R _{thJC} K/W	P _D W	Fig. No.	Package style Outline drawings on pages O-36...O-59
IXFA 130N10T	100	130	0.0091	5080	104	67	0.42	360	X011b	D5 DE 475 
IXFP 130N10T		130	0.0091	5080	104	67	0.42	360	X005a	
IXFH 230N10T		230	0.0047	15300	250	-82	0.23	650	X014a	
IXFX 360N10T		360	0.0029	33000	525	130	0.12	1250	X015a	
IXFN 360N10T		360	0.0026	33000	525	130	0.18	830	X027a	
IXFK 360N10T		360	0.0029	33000	525	130	0.12	1250	X020a	
IXFX 420N10T		420	0.0026	47000	670	140	0.09	1670	X015a	
IXFN 420N10T		420	0.0023	47000	670	140	0.14	1070	X027a	
IXFK 420N10T		420	0.0026	47000	670	140	0.09	1670	X020a	
IXFA 102N15T	150	102	0.0180	5220	87	120	0.33	455	X011b	X011b TO-263AB 
IXFH 102N15T		102	0.0180	5220	87	120	0.33	455	X014a	
IXFP 102N15T		102	0.0180	5220	87	120	0.33	455	X005a	
IXFH 160N15T		160	0.0096	8800	160	90	0.18	830	X014a	
IXFH 150N20T	200	150	0.0150	11700	177	-100	0.14	890	X014a	X014a TO-247AD 
IXFT 150N20T		150	0.0150	11700	177	-100	0.14	890	X019	
IXFR 230N20T		156	0.0080	28000	378	200	0.25	600	X016a	
IXFX 170N20T		170	0.0110	19600	265	200	0.13	1150	X015a	
IXFK 170N20T		170	0.0110	19600	265	200	0.13	1150	X020a	
IXFN 230N20T		220	0.0075	28000	378	200	0.138	1090	X027a	
IXFX 230N20T		230	0.0075	28000	378	200	0.09	1670	X015a	
IXFK 230N20T		230	0.0075	28000	378	200	0.90	1670	X020a	
IXFZ 140N25T	250	100	0.0170	19000	255	200	0.28	445	D5	
IXFH 110N25T		110	0.0240	9400	157	170	0.18	694	X014a	X016a ISOPLUS247™ 
IXFH 120N25T		120	0.0230	11300	180	-108	0.14	890	X014a	
IXFT 120N25T		120	0.0230	11300	180	-108	0.14	890	X019	
IXFN 140N25T		120	0.0170	19000	255	200	0.18	690	X027a	
IXFX 140N25T		140	0.0170	19000	255	200	0.13	960	X015a	
IXFK 140N25T		140	0.0170	19000	255	200	0.13	960	X020a	
IXFN 180N25T		168	0.0129	23800	364	200	0.138	900	X027a	
IXFX 180N25T		180	0.0129	23800	364	200	0.09	1390	X015a	
IXFK 180N25T		180	0.0129	23800	364	200	0.09	1390	X020a	
IXFH 46N30T	300	46	0.0800	4770	86	150	0.27	460	X014a	X019 TO-268AA 
IXFT 46N30T		46	0.0800	4770	86	150	0.27	460	X019	
IXFH 86N30T		86	0.0430	11300	180	150	0.15	830	X014a	
IXFT 86N30T		86	0.0430	11300	180	150	0.15	830	X019	
IXFH 94N30T		94	0.0360	11400	190	-155	0.14	890	X014a	
IXFT 94N30T		94	0.0360	11400	190	-155	0.14	890	X019	
IXFX 120N30T		120	0.0240	20000	265	200	0.13	960	X015a	
IXFK 120N30T		120	0.0240	20000	265	200	0.13	960	X020a	
IXFN 160N30T		130	0.0190	28000	335	200	0.138	900	X027a	
IXFX 160N30T		160	0.0190	28000	335	200	0.09	1390	X015a	
IXFK 160N30T		160	0.0190	28000	335	200	0.09	1390	X020a	

TrenchT2™ Power MOSFETs

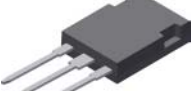
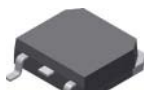

Part Type	V _{DSS} V	I _{D(cont)} Chip T _C = 25°C A	R _{DS(on)} T _C = 25°C Ω	C _{iss} typ. pF	Q _g typ. nC	t _{rr} typ. ns	R _{thJC} K/W	P _D W	Fig. No.	Package style Outline drawings on pages O-36...O-59	
IXTP 100N04T2	40	100	0.0070	2690	25.5	34	1.00	150	X005a	D5 DE 475 	
IXTA 100N04T2		100	0.0070	2690	25.5	34	1.00	150	X011b		
IXTP 120N04T2		120	0.0061	3240	58	35	0.75	200	X005a		
IXTA 120N04T2		120	0.0061	3240	58	35	0.75	200	X011b	X004 TO-252AA 	
IXTP 160N04T2		160	0.0050	4640	79	40	0.60	250	X005a		
IXTA 160N04T2		160	0.0050	4640	79	40	0.60	250	X011b		
IXTP 220N04T2		220	0.0035	6820	112	45	0.42	360	X005a	X005a TO-220AB 	
IXTA 220N04T2		220	0.0035	6820	112	45	0.42	360	X011b		
IXTP 300N04T2		300	0.0025	10700	145	53	0.31	480	X005a		
IXTH 300N04T2		300	0.0025	10700	145	53	0.31	480	X014a	X015a	
IXTA 300N04T2		300	0.0025	10700	145	53	0.31	480	X011b		
IXTH 420N04T2		420	0.0020	19700	315	74	0.16	935	X014a		
IXTH 500N04T2		500	0.0016	25000	405	84	0.15	1000	X014a	X019	
IXTT 500N04T2		500	0.0016	25000	405	84	0.15	1000	X019		
IXTX 600N04T2		600	0.0015	40000	590	100	0.12	1250	X015a		
IXTN 600N04T2		600	0.00105	40000	590	100	0.16	940	X027a	X020a	
IXTK 600N04T2		600	0.0015	40000	590	100	0.12	1250	X020a		
IXTA 90N055T2	55	90	0.0084	2770	42	37	1.00	150	X011b		X011b TO-263AB 
IXTP 90N055T2		90	0.0084	2770	42	37	1.00	150	X005a		
IXTY 90N055T2		90	0.0084	2770	42	37	1.00	150	X004		
IXTP 110N055T2		110	0.0066	3060	57	38	0.82	180	X005a	X014a TO-247AD 	
IXTA 110N055T2		110	0.0066	3060	57	38	0.82	180	X011b		
IXTP 140N055T2		140	0.0054	4760	82	40	0.60	250	X005a		
IXTA 140N055T2		140	0.0054	4760	82	40	0.60	250	X011b	X015a PLUS247 	
IXTP 200N055T2		200	0.0042	6970	109	49	0.42	360	X005a		
IXTA 200N055T2		200	0.0042	6970	109	49	0.42	360	X011b		
IXTP 260N055T2		260	0.0033	10800	140	60	0.31	480	X005a	X014a	
IXTH 260N055T2		260	0.0033	10800	140	60	0.31	480	X014a		
IXTA 260N055T2		260	0.0033	10800	140	60	0.31	480	X011b		
IXTH 360N055T2		360	0.0024	20000	330	78	0.16	935	X014a	X019	
IXTT 360N055T2		360	0.0024	20000	330	78	0.16	935	X019		
IXTH 440N055T2		440	0.0018	25000	405	76	0.15	1000	X014a		
IXTT 440N055T2		440	0.0018	25000	405	76	0.15	1000	X019	X019	
IXTX 550N055T2		550	0.0016	40000	595	100	0.12	1250	X015a		
IXTN 550N055T2	550	0.0013	40000	595	100	0.16	940	X027a			
IXTK 550N055T2	550	0.0016	40000	595	100	0.12	1250	X020a	X019 TO-268AA 		
IXTZ 550N055T2	550	0.0010	40000	595	100	0.25	600	D5			
IXTP 130N065T2	65	130	0.0066	4800	79	41	0.60	250		X005a	
IXTA 130N065T2		130	0.0066	4800	79	41	0.60	250	X011b		
IXTP 70N075T2	75	70	0.0120	2580	46	48	1.00	150	X005a	X020a TO-264 	
IXTA 70N075T2		70	0.0120	2580	46	48	1.00	150	X011b		
IXTP 90N075T2		90	0.0100	3290	54	50	0.82	180	X005a		
IXTA 90N075T2		90	0.0100	3290	54	50	0.82	180	X011b	X027a SOT-227B miniBLOC 	
IXTP 120N075T2		120	0.0077	4740	78	50	0.60	250	X005a		
IXTA 120N075T2		120	0.0077	4740	78	50	0.60	250	X011b		
IXTP 170N075T2		170	0.0054	6860	109	63	0.42	360	X005a	X005a	
IXTA 170N075T2		170	0.0054	6860	109	63	0.42	360	X011b		
IXTP 230N075T2		230	0.0042	10.5	178	66	0.31	480	X005a		
IXTA 230N075T2		230	0.0042	10.5	178	66	0.31	480	X011b	X005a	
IXTP 80N12T2		120	80	0.0170	4740	80	90	0.46	325		X005a
IXTA 80N12T2			80	0.0170	4740	80	90	0.46	325		X011b



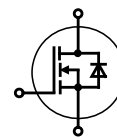





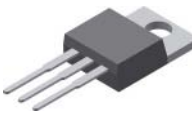

TrenchT2™ Power MOSFETs

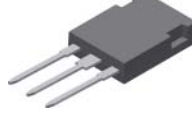

TrenchT2™ MOSFETs in SMPD Package

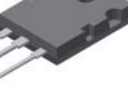
Part Type	V _{DSS} V	I _{D(cont)} Chip T _C = 25°C A	R _{DS(on)} T _C = 25°C Ω	C _{iss} typ. pF	Q _g typ. nC	t _{rr} typ. ns	R _{thJC} K/W	P _D W	Fig. No.	Package style Outline drawings on pages O-36...O-59
MMIX 1T600N04T2	40	600	0.0013	40000	590	100	0.18	830	X031a	 SMPD-X
MMIX 1T550N055T2	55	550	0.0013	40000	595	100	0.18	830		
MMIX 1F520N075T2	75	500	0.0016	41000	545	150	0.18	830		

TrenchT2™ HiPerFET™ Power MOSFETs

IXFP 230N075T2	75	230	0.0042	10500	178	59	0.31	480	X005a	 DE 475
IXFH 230N075T2		230	0.0042	10500	178	59	0.31	480	X014a	
IXFA 230N075T2		230	0.0042	10500	178	59	0.31	480	X011b	
IXFH 340N075T2	340	340	0.0032	19000	300	75	0.16	935	X014a	 TO-220AB
IXFT 340N075T2		340	0.0032	19000	300	75	0.16	935	X019	
IXFH 400N075T2		400	0.0023	24000	420	77	0.15	1000	X014a	
IXFT 400N075T2	400	0.0023	24000	420	77	0.15	1000	X019	 TO-220FPAB	
IXFZ 520N075T2	420	0.0016	41000	545	n/a	0.25	600	D5		
IXFN 520N075T2	480	0.0019	41000	545	n/a	0.16	940	X027a		
IXFX 520N075T2	520	0.0022	41000	545	n/a	0.12	1250	X015a	 TO-263AB	
IXFK 520N075T2	520	0.0022	41000	545	n/a	0.12	1250	X020a		
IXFP 130N10T2	100	130	0.0091	6600	130	n/a	0.42	360		X005a
IXFA 130N10T2		130	0.0091	6600	130	n/a	0.42	360	X011b	
IXFP 180N10T2		180	0.0060	10500	185	66	0.31	480	X005a	
IXFA 180N10T2	180	0.0060	10500	185	66	0.31	480	X011b	 TO-247AD	
IXFH 320N10T2	320	0.0035	25000	430	98	0.15	1000	X014a		
IXFT 320N10T2	320	0.0035	26000	430	98	0.15	1000	X019		
IXFP 76N15T2	150	76	0.0200	5800	97	69	0.43	350	X007a	 PLUS247
IXFA 76N15T2		76	0.0200	5800	97	69	0.43	350	X011b	
IXFP 110N15T2		110	0.0130	8600	150	85	0.31	480	X005a	
IXFH 110N15T2	110	0.0130	8600	150	85	0.31	480	X014a	 TO-268AA	
IXFA 110N15T2	110	0.0130	8600	150	85	0.31	480	X011b		
IXFH 160N15T2	160	0.0090	15000	253	n/a	0.17	880	X014a		
IXFX 240N15T2	240	0.0052	32000	460	n/a	0.12	1250	X015a	 TO-264	
IXFN 240N15T2	240	0.0052	32000	460	n/a	0.18	830	X027a		
IXFK 240N15T2	240	0.0052	32000	460	n/a	0.12	1250	X020a		
IXFN 360N15T2	310	0.0040	47500	715	n/a	0.14	1070	X027a	 SOT-227B miniBLOC	
IXFX 360N15T2	360	0.0040	47500	715	n/a	0.09	1670	X015a		
IXFK 360N15T2	360	0.0040	47500	715	n/a	0.09	1670	X020a		
IXFX 220N17T2	170	220	0.0063	31000	500	n/a	0.12	1250	X015a	 SOT-227B miniBLOC
IXFK 220N17T2		220	0.0063	31000	500	n/a	0.12	1250	X020a	
IXFN 320N17T2		260	0.0052	45000	640	n/a	0.14	1070	X027a	
IXFX 320N17T2	320	0.0052	45000	640	n/a	0.09	1670	X015a	 SOT-227B miniBLOC	
IXFK 320N17T2	320	0.0052	45000	640	n/a	0.09	1670	X020a		
IXFH 150N17T2	175	150	0.0120	14600	233	n/a	0.17	880		X014a
IXFT 150N17T2		150	0.0120	14600	233	n/a	0.17	880	X019	

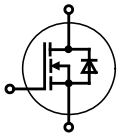

TrenchT3/T4™ HiPerFET™ Power MOSFETs

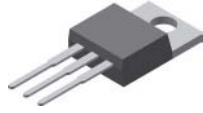

TrenchT3™ HiPerFET™ Power MOSFETs

Part Type	V _{DSS}	I _{D(cont)} Chip T _C = 25°C	R _{DS(on)} T _C = 25°C	C _{iss}	Q _g	t _{rr}	R _{thJC}	P _D	Fig. No.	Package style Outline drawings on pages O-36...O-59
	V	A	Ω	pF	nC	ns	K/W	W		
IXFA 220N06T3	60	220	0.0040	8500	136	38	0.340	440	X011b	X005a TO-220AB 
IXFH 220N06T3		220	0.0040	8500	136	38	0.340	440	X014a	
IXFP 220N06T3		220	0.0040	8500	136	38	0.340	440	X005a	
IXFA 270N06T3		270	0.0031	12600	200	47	0.310	480	X011b	
IXFH 270N06T3		270	0.0031	12600	200	47	0.310	480	X014a	
IXFP 270N06T3		270	0.0031	12600	200	47	0.310	480	X005a	

TrenchT4™ Power MOSFETs

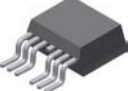
Part Type	V _{DSS}	I _{D(cont)} Chip T _C = 25°C	R _{DS(on)} T _C = 25°C	C _{iss}	Q _g	t _{rr}	R _{thJC}	P _D	Fig. No.	Package style
➤ New	V	A	Ω	pF	nC	ns	K/W	W		
IXTA 380N036T4-7	36	380	0.0010	13400	260	54	0.310	480	X012c	X007a TO-220FPAB 
IXTA 230N04T4	40	230	0.0029	7400	140	32	0.440	340	X011b	
IXTP 230N04T4		230	0.0029	7400	140	32	0.440	340	X005a	X011b TO-263AB 
➤ IXTP 230N04T4M		230	0.0029	7400	140	32	3.750	40	X007a	
IXTP 270N04T4		270	0.0024	9140	182	48	0.400	375	X005a	
IXTA 270N04T4-7		270	0.0022	9140	182	48	0.400	375	X012c	
IXTH 270N04T4		270	0.0024	9140	182	48	0.400	375	X014a	
IXTA 270N04T4		270	0.0022	9140	182	48	0.400	375	X011b	
IXTA 340N04T4		340	0.0017	13000	256	43	0.310	480	X011b	
IXTA 340N04T4-7		340	0.0017	13000	256	43	0.310	480	X012c	
IXTH 340N04T4		340	0.0019	13000	256	43	0.310	480	X014a	
IXTP 340N04T4		340	0.0019	13000	256	43	0.310	480	X005a	
IXTT 440N04T4HV		440	0.00125	26000	480	72	0.160	940	X019a	X012c TO-263AB 
IXTN 660N04T4		660	0.00085	44000	860	60	0.144	1040	X027a	

X027a **SOT-227B miniBLOC**







X019a **TO-268HV**

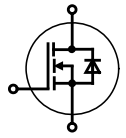

X014a **TO-247AD**

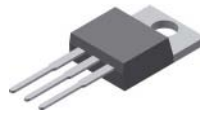

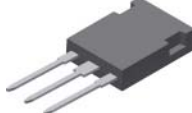
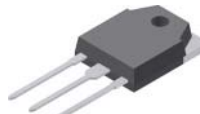



Part Type	V _{DSS} V	I _{D(cont)} Chip T _J = 25°C A	R _{DS(on)} T _J = 25°C Ω	C _{iss} typ pF	Q _g typ nC	t _{rr} typ ns	R _{thJC} K/W	P _D W	Fig. No.	Package style Outline drawings on pages O-36...O-59	
IXTP 75N10P IXTA 75N10P IXTQ 75N10P IXTT 110N10P IXTQ 110N10P IXTR 200N10P	100	75 75 75 110 110 120	0.025 0.025 0.025 0.015 0.015 0.008	2250 2250 2250 3550 3550 7600	74 74 74 110 110 235	120 120 120 130 130 100	0.42 0.42 0.42 0.31 0.31 0.50	360 360 360 480 480 300	X005a X011b X017a X019 X017a X016a	X005a TO-220AB 	
IXTT 140N10P IXTQ 140N10P IXTK 170N10P IXTT 170N10P IXTQ 170N10P IXTK 200N10P		140 140 170 170 170 200	0.011 0.011 0.009 0.009 0.009 0.0075	4700 4700 6000 6000 6000 7600	155 155 198 198 198 240	120 120 120 120 120 100	0.25 0.25 0.21 0.21 0.21 0.18	600 600 715 715 715 800	X019 X017a X020a X019 X017a X020a		X011b TO-263AB 
IXTP 62N15P IXTA 62N15P IXTQ 62N15P IXTT 96N15P IXTQ 96N15P IXTT 120N15P IXTQ 120N15P IXTK 150N15P IXTQ 150N15P IXTK 180N15P	150	62 62 62 96 96 120 120 150 150 180	0.040 0.040 0.040 0.024 0.024 0.016 0.016 0.013 0.013 0.010	2250 2250 2250 3500 3500 4900 4900 5800 5800 7000	70 70 70 110 110 150 150 190 190 240	150 150 150 150 150 150 150 150 150 150	0.42 0.42 0.42 0.31 0.31 0.25 0.25 0.21 0.21 0.18	350 350 350 480 480 600 600 714 714 800	X005a X011b X017a X019 X017a X019 X017a X020a X017a X020a		X014a TO-247AD 
IXTP 50N20P IXTA 50N20P IXTQ 50N20P IXTT 74N20P IXTQ 74N20P IXTH 96N20P IXTT 96N20P IXTQ 96N20P IXTK 120N20P IXTQ 120N20P IXTK 140N20P	200	50 50 50 74 74 96 96 96 120 120 140	0.060 0.060 0.060 0.034 0.034 0.024 0.024 0.024 0.022 0.022 0.018	2720 2720 2720 3300 3300 4800 4800 4800 6000 6000 7500	70 70 70 107 107 145 145 145 152 152 240	150 150 150 160 160 160 160 180 180 180 180	0.42 0.42 0.42 0.31 0.31 0.25 0.25 0.21 0.21 0.21 0.18	360 360 360 480 480 600 600 714 714 714 800	X005a X011b X017a X019 X017a X014a X019 X017a X020a X017a X020a		X016a ISOPLUS247™ 
IXTP 42N25P IXTA 42N25P IXTQ 42N25P IXTT 64N25P IXTQ 64N25P IXTK 82N25P IXTT 82N25P IXTQ 82N25P IXTK 100N25P IXTT 100N25P IXTQ 100N25P IXTK 120N25P	250	42 42 42 64 64 82 82 82 100 100 100 120	0.084 0.084 0.084 0.049 0.049 0.035 0.035 0.035 0.027 0.027 0.027 0.024	2300 2300 2300 3450 3450 4800 4800 4800 6300 6300 6300 8700	70 70 70 105 105 142 142 142 185 185 185 200	200 200 200 200 200 200 200 200 200 200 200 200	0.42 0.42 0.42 0.31 0.31 0.25 0.25 0.25 0.21 0.21 0.21 0.18	300 300 300 400 400 500 500 500 600 600 600 700	X005a X011b X017a X019 X017a X020a X019 X017a X020a X019 X017a X020a		X017a TO-3P 
IXTP 36N30P IXTA 36N30P IXTQ 36N30P IXTT 52N30P IXTQ 52N30P IXTT 69N30P IXTQ 69N30P IXTH 88N30P IXTK 88N30P IXTT 88N30P IXTQ 88N30P IXTK 102N30P IXTK 140N30P	300	36 36 36 52 52 69 69 88 88 88 88 102 140	0.110 0.110 0.110 0.066 0.066 0.049 0.049 0.040 0.040 0.040 0.040 0.033 0.240	2250 2250 2250 3490 3490 4960 4960 6300 6300 6300 6300 7500 14800	70 70 70 110 110 156 156 180 180 180 180 224 185	250 250 250 250 250 330 330 250 250 250 250 250 250	0.42 0.42 0.42 0.31 0.31 0.25 0.25 0.21 0.21 0.21 0.21 0.18 0.12	300 300 300 400 400 500 500 600 600 600 600 700 1040	X005a X011b X017a X019 X017a X019 X017a X014a X020a X019 X017a X020a		X020a TO-264 

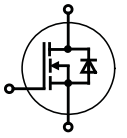

Polar™ Standard MOSFETs



Part Type	V _{DSS}	I _{D(cont)} Chip T _C = 25°C	R _{DS(on)} T _J = 25°C	C _{iss} typ	Q _g typ	t _{rr} typ	R _{thJC}	P _D	Fig. No.	Package style Outline drawings on pages O-36...O-59
➤ New	V	A	Ω	pF	nC	ns	K/W	W		
IXTP 12N50P	500	12	0.50	1830	29	300	0.62	200	X005a	X004 TO-252AA 
IXTA 12N50P		12	0.50	1830	29	300	0.62	200	X011b	
IXTP 16N50P		16	0.40	2480	43	400	0.42	300	X005a	
IXTA 16N50P		16	0.40	2480	43	400	0.42	300	X011b	
IXTQ 16N50P		16	0.40	2480	43	400	0.42	300	X017a	
IXTH 22N50P		22	0.27	2880	50	400	0.35	350	X014a	
IXTQ 22N50P		22	0.27	2880	50	400	0.35	350	X017a	
IXTT 26N50P		26	0.23	3600	65	300	0.31	400	X019	
IXTQ 26N50P		26	0.23	3600	65	300	0.31	400	X017a	
IXTH 30N50P		30	0.20	4150	70	400	0.27	460	X014a	
IXTT 30N50P		30	0.20	4150	70	400	0.27	460	X019	
IXTQ 30N50P		30	0.20	4150	70	400	0.27	460	X017a	
IXTH 36N50P		36	0.17	4700	82	400	0.23	540	X014a	
IXTT 36N50P		36	0.17	4700	82	400	0.23	540	X019	
IXTQ 36N50P		36	0.17	4700	82	400	0.23	540	X017a	
IXTQ 44N50P		44	0.14	5440	98	400	0.19	650	X017a	
IXTP 10N60P	600	10	0.74	1720	32	500	0.62	200	X005a	X005a TO-220AB 
IXTA 10N60P		10	0.74	1720	32	500	0.62	200	X011b	
IXTP 14N60P		14	0.55	2500	36	500	0.42	300	X005a	
IXTA 14N60P		14	0.55	2500	36	500	0.42	300	X011b	
IXTQ 14N60P		14	0.55	2500	36	500	0.42	300	X017a	
IXTQ 18N60P		18	0.42	2500	49	500	0.35	360	X017a	
IXTQ 22N60P		22	0.35	3600	62	500	0.31	400	X017a	
IXTH 26N60P		26	0.27	4150	72	500	0.27	460	X014a	
IXTT 26N60P		26	0.27	4150	72	500	0.27	460	X019	
IXTQ 26N60P		26	0.27	4150	72	500	0.27	460	X017a	
IXTH 30N60P		30	0.24	5050	82	500	0.23	540	X014a	
IXTT 30N60P		30	0.24	5050	82	500	0.23	540	X019	
IXTQ 30N60P	30	0.24	5050	82	500	0.23	540	X017a		
IXTP 05N100P	1000	0.5	30	196	8.1	750	2.50	50	X005a	X014a TO-247AD 
IXTA 05N100P		0.5	30	196	8.1	750	2.50	50	X011b	
IXTP 08N100P		0.8	20	240	11.3	750	3.00	42	X005a	
IXTY 08N100P		0.8	20	240	11.3	750	3.00	42	X004	
IXTA 08N100P		0.8	20	240	11.3	750	3.00	42	X011b	
IXTP 1N100P		1.0	15	331	15.5	750	2.50	50	X005a	
IXTY 1N100P		1.0	15	331	15.5	750	2.50	50	X004	
IXTA 1N100P		1.0	15	331	15.5	750	2.50	50	X011b	
IXTP 1R4N100P		1.4	11	450	17.8	750	2.00	63	X005a	
IXTY 1R4N100P		1.4	11	450	17.8	750	2.00	63	X004	
IXTA 1R4N100P		1.4	11	666	17.8	750	2.00	63	X011b	
IXTP 2N100P		2.0	7.5	655	24.3	800	1.45	86	X005a	
IXTY 2N100P		2.0	7.5	655	24.3	800	1.45	86	X004	
IXTA 2N100P		2.0	7.5	655	24.3	800	1.45	86	X011b	
IXTP 3N100P		3.0	4.8	1100	39	820	1.00	125	X005a	
IXTH 3N100P		3.0	4.8	1100	39	820	1.00	125	X014a	
IXTA 3N100P		3.0	4.8	1100	39	820	1.00	125	X011b	
IXTP 02N120P		1200	0.2	75	104	4.7	1600	3.80	33	
IXTY 02N120P	0.2		75	104	4.7	1600	3.80	33	X004	
IXTP 06N120P	0.6		34	236	13.3	900	3.00	42	X005a	
IXTA 06N120P	0.6		34	236	13.3	900	3.00	42	X011b	
IXTP 08N120P	0.8		25	333	14	900	2.50	50	X005a	
IXTA 08N120P	0.8		25	333	14	900	2.50	50	X011b	
IXTP 1N120P	1.0		20	445	17.6	900	2.00	63	X005a	
IXTA 1N120P	1.0		20	445	17.6	900	2.00	63	X011b	
IXTP 1R4N120P	1.4		13	666	24.8	900	1.45	86	X005a	
➤ IXTY 1R4N120P	1.4		13	666	24.8	900	1.45	86	X004	
➤ IXTY 1R4N120PHV	1.4		13	666	24.8	900	1.45	86	X004a	
IXTA 1R4N120P	1.4		13	725	24.8	900	1.45	86	X011b	
IXTP 2R4N120P	2.4		7.5	1207	37	920	1.00	125	X005a	
IXTH 2R4N120P	2.4		7.5	1207	37	920	1.00	125	X014a	
IXTA 2R4N120P	2.4	7.5	1207	37	920	1.00	125	X011b		

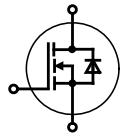

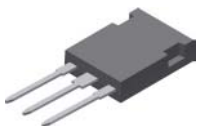

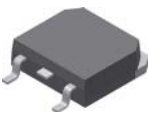



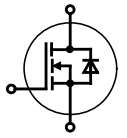















Polar™ HiPerFET™ MOSFETs with Fast Intrinsic Diode



Part Type	V _{DSS}	I _{D(cont)} Chip T _C = 25°C	R _{DS(on)} T _J = 25°C	C _{iss} typ	Q _g typ	t _{rr} typ	R _{thJC}	P _D	Fig. No.	Package style Outline drawings on pages O-36...O-59	
	V	A	Ω	pF	nC	ns	K/W	W			
IXFH 110N10P	100	110	0.0150	3550	110	150	0.31	480	X014a	 <p>TO-247AD</p>	
IXFR 200N10P		120	0.0090	7600	235	150	0.50	300	X016a		
IXFH 140N10P		140	0.0110	4700	155	150	0.25	600	X014a		
IXFT 140N10P		140	0.0110	4700	155	150	0.25	600	X019		
IXFH 170N10P		170	0.0090	6000	198	150	0.21	715	X014a		
IXFK 170N10P		170	0.0090	6000	198	150	0.21	715	X020a		
IXFX 200N10P		200	0.0075	7600	235	150	0.18	830	X015a		
IXFN 200N10P		200	0.0075	7600	235	150	0.22	680	X027a		
IXFK 200N10P		200	0.0075	7600	235	150	0.18	830	X020a		
IXFX 250N10P		250	0.0065	16000	205	200	0.12	1250	X015a		
IXFK 250N10P		250	0.0065	16000	205	200	0.12	1250	X020a		
IXFN 300N10P		295	0.0055	23	279	200	0.14	1070	X027a		
IXFB 300N10P		300	0.0055	23	279	200	0.10	1500	X021a		
IXFH 96N15P	150	96	0.0240	3500	110	200	0.31	480	X014a		 <p>PLUS247</p>
IXFR 180N15P		100	0.0130	7000	240	200	0.50	300	X016a		
IXFH 120N15P		120	0.0160	4900	150	200	0.25	600	X014a		
IXFT 120N15P		120	0.0160	4900	150	200	0.25	600	X019		
IXFN 180N15P		150	0.0110	7000	240	200	0.22	680	X027a		
IXFH 150N15P		150	0.0130	5800	190	200	0.21	714	X014a		
IXFK 150N15P		150	0.0130	5800	190	200	0.21	714	X020a		
IXFX 180N15P		180	0.0110	7000	240	200	0.18	830	X015a		
IXFK 180N15P		180	0.0110	7000	240	200	0.18	830	X020a		
IXFX 220N15P		220	0.0090	15.4	162	200	0.12	1250	X015a		
IXFK 220N15P		220	0.0090	15.4	162	200	0.12	1250	X020a		
IXFH 74N20P	200	74	0.0340	3300	107	200	0.31	480	X014a	 <p>ISOPLUS247™</p>	
IXFR 140N20P		90	0.0220	7500	240	200	0.50	300	X016a		
IXFH 96N20P		96	0.0240	4800	145	200	0.25	600	X014a		
IXFT 96N20P		96	0.0240	4800	145	200	0.25	600	X019		
IXFN 140N20P		115	0.0180	7500	240	200	0.22	680	X027a		
IXFH 120N20P		120	0.0220	6000	152	200	0.21	714	X014a		
IXFK 120N20P		120	0.0220	6000	152	200	0.21	714	X020a		
IXFK 140N20P		140	0.0180	7500	240	200	0.18	830	X020a		
IXFX 170N20P		170	0.0140	11.4	185	200	0.12	1250	X015a		
IXFK 170N20P		170	0.0140	11.4	185	200	0.12	1250	X020a		
IXFN 210N20P		188	0.0105	18.6	255	200	0.14	1070	X027a		
IXFB 210N20P		210	0.0105	18.6	255	200	0.10	1500	X021a		
IXFH 100N25P	250	100	0.0270	6300	185	200	0.21	600	X014a		 <p>TO-268AA</p>
IXFX 120N25P		120	0.0240	8700	185	200	0.18	700	X015a		
IXFK 120N25P		120	0.0240	8700	185	200	0.18	700	X020a		
IXFH 52N30P	300	52	0.0660	3490	110	200	0.31	400	X014a		
IXFR 102N30P		60	0.0360	7500	224	200	0.50	250	X016a		
IXFH 69N30P		69	0.0490	4960	156	200	0.25	500	X014a		
IXFT 69N30P		69	0.0490	4960	156	200	0.25	500	X019		
IXFR 140N30P		70	0.0260	14800	185	200	0.35	360	X016a		
IXFN 102N30P		86	0.0330	7500	224	200	0.22	570	X027a		
IXFH 88N30P		88	0.0400	6300	180	200	0.21	600	X014a		
IXFK 88N30P		88	0.0400	6300	180	200	0.21	600	X020a		
IXFT 88N30P		88	0.0400	6300	180	200	0.21	600	X019		
IXFK 102N30P		102	0.0330	7500	224	200	0.18	700	X020a		
IXFN 140N30P		110	0.0240	14800	185	200	0.18	700	X027a		
IXFN 170N30P		138	0.0018	20	258	200	0.14	890	X027a		
IXFX 140N30P		140	0.0240	14800	185	200	0.12	1040	X015a		
IXFK 140N30P		140	0.0240	14800	185	200	0.12	1040	X020a		
IXFB 170N30P		170	0.0180	20	258	200	0.10	1250	X021a		







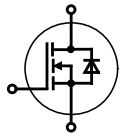

Polar™ HiPerFET™ MOSFETs with Fast Intrinsic Diode

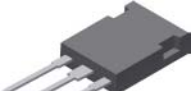

Part Type	V _{DSS} V	I _{D(cont)} Chip T _C = 25°C A	R _{DS(on)} T _J = 25°C Ω	C _{iss} typ pF	Q _g typ nC	t _{rr} typ ns	R _{thJC} K/W	P _D W	Fig. No.	Package style Outline drawings on pages O-36...O-59	
IXFP 12N50P	500	12	0.500	1830	29	200	0.62	200	X005a	X005a TO-220AB 	
IXFA 12N50P		12	0.500	1830	29	200	0.62	200	X011b		
IXFP 16N50P		16	0.400	2480	43	200	0.42	300	X005a		
IXFH 16N50P		16	0.400	2480	43	200	0.42	300	X014a		
IXFA 16N50P		16	0.400	2480	43	200	0.42	300	X011b		
IXFR 36N50P		19	0.190	5500	93	200	0.75	156	X016a		X011b TO-263AB 
IXFH 22N50P		22	0.270	2880	50	200	0.35	350	X014a		
IXFR 44N50P		24	0.150	5440	98	200	0.60	208	X016a		X014a TO-247AD 
IXFH 26N50P		26	0.230	3600	60	200	0.31	400	X014a		
IXFH 30N50P		30	0.200	4150	70	200	0.27	460	X014a		X014a TO-247AD 
IXFT 30N50P	30	0.200	4150	70	200	0.27	460	X019			
IXFH 36N50P	36	0.170	5500	93	200	0.23	540	X014a	X015a PLUS247 		
IXFT 36N50P	36	0.170	5500	93	200	0.23	540	X019			
IXFR 64N50P	37	0.095	9700	150	200	0.42	300	X016a	X016a ISOPLUS247™ 		
IXFH 44N50P	44	0.140	5440	98	200	0.19	650	X014a			
IXFK 44N50P	44	0.140	5440	98	200	0.19	650	X020a	X019 TO-268AA 		
IXFT 44N50P	44	0.140	5440	98	200	0.19	650	X019			
IXFR 80N50P	45	0.072	12700	197	200	0.35	360	X016a	X016a ISOPLUS247™ 		
IXFN 64N50P	50	0.085	9700	150	200	0.20	625	X027a			
IXFX 64N50P	64	0.085	9700	150	200	0.15	830	X015a	X019 TO-268AA 		
IXFK 64N50P	64	0.085	9700	150	200	0.15	830	X020a			
IXFN 80N50P	66	0.065	12700	195	200	0.18	700	X027a	X020a TO-264 		
IXFL 100N50P	68	0.052	20000	240	200	0.20	625	X022a			
IXFX 80N50P	80	0.065	12700	197	200	0.12	1040	X015a	X021a PLUS264 		
IXFK 80N50P	80	0.065	12700	197	200	0.12	1040	X020a			
IXFN 100N50P	90	0.049	20000	240	200	0.12	1040	X027a	X021a PLUS264 		
IXFB 100N50P	100	0.049	20000	240	200	0.10	1250	X021a			
IXFP 10N60P	600	10	0.740	1720	32	200	0.62	200	X005a	X020a TO-264 	
IXFA 10N60P		10	0.740	1720	32	200	0.62	200	X011b		
IXFP 14N60P		14	0.550	2500	36	200	0.42	300	X005a		
IXFH 14N60P		14	0.550	2500	36	200	0.42	300	X014a		
IXFA 14N60P		14	0.550	2500	36	200	0.42	300	X011b		
IXFR 30N60P		15	0.250	3820	85	200	0.75	166	X016a		X021a PLUS264 
IXFH 18N60P		18	0.400	2500	50	200	0.35	360	X014a		
IXFR 36N60P		20	0.200	5800	102	200	0.60	208	X016a		X022a ISOPLUS264™ 
IXFH 22N60P		22	0.350	3600	58	200	0.31	400	X014a		
IXFH 26N60P		26	0.270	4150	72	200	0.27	460	X014a		X027a SOT-227B miniBLOC 
IXFT 26N60P	26	0.270	4150	72	200	0.27	460	X019			
IXFH 30N60P	30	0.240	4000	82	200	0.25	500	X014a	X027a SOT-227B miniBLOC 		
IXFT 30N60P	30	0.240	4000	82	200	0.25	500	X019			
IXFR 48N60P	32	0.150	8860	150	200	0.42	300	X016a	X022a ISOPLUS264™ 		
IXFR 64N60P	36	0.105	12000	200	200	0.35	360	X016a			
IXFH 36N60P	36	0.190	5800	102	200	0.19	650	X014a	X027a SOT-227B miniBLOC 		
IXFK 36N60P	36	0.190	5800	102	200	0.19	650	X020a			
IXFT 36N60P	36	0.190	5800	102	200	0.19	650	X019	X027a SOT-227B miniBLOC 		
IXFN 48N60P	40	0.140	8860	150	200	0.20	625	X027a			
IXFX 48N60P	48	0.135	8860	150	200	0.15	830	X015a	X027a SOT-227B miniBLOC 		
IXFK 48N60P	48	0.135	8860	150	200	0.15	830	X020a			
IXFN 64N60P	50	0.096	12000	200	200	0.18	700	X027a	X027a SOT-227B miniBLOC 		
IXFL 82N60P	55	0.078	23000	240	200	0.20	625	X022a			
IXFX 64N60P	64	0.096	12000	200	200	0.12	1040	X015a	X027a SOT-227B miniBLOC 		
IXFK 64N60P	64	0.096	12000	200	200	0.12	1040	X020a			
IXFN 82N60P	72	0.075	23000	240	200	0.12	1040	X027a	X027a SOT-227B miniBLOC 		
IXFB 82N60P	82	0.075	23000	240	200	0.10	1250	X021a			

Polar™ HiPerFET™ MOSFETs with Fast Intrinsic Diode

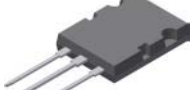

Part Type	V_{DSS}	$I_{D(cont)}$ Chip	$R_{DS(on)}$	C_{iss}	Q_g	t_{rr}	R_{thJC}	P_D	Fig. No.	Package style Outline drawings on pages O-36...O-59
	V	$T_C = 25^\circ C$ A	$T_J = 25^\circ C$ Ω	typ pF	typ nC	typ ns	K/W	W		
IXFP 7N80P	800	7	1.440	1800	32	250	0.62	200	X005a	X005a TO-220AB 
IXFA 7N80P		7	1.440	1800	32	250	0.62	200	X011b	
IXFR 20N80P		10	0.570	4685	86	250	0.80	160	X016a	X011b TO-263AB 
IXFP 10N80P		10	1.100	2050	40	250	0.42	300	X005a	
IXFH 10N80P		10	1.100	2050	40	250	0.42	300	X014a	X014a TO-247AD 
IXFA 10N80P		10	1.100	2050	40	250	0.42	300	X011b	
IXFQ 10N80P		10	1.100	2050	40	250	0.42	300	X017a	X014a PLUS247 
IXFH 12N80P		12	0.850	2800	51	250	0.35	360	X014a	
IXFR 24N80P		13	0.420	7200	105	250	0.60	208	X016a	X015a ISOPLUS247™ 
IXFH 14N80P		14	0.720	3900	61	250	0.31	400	X014a	
IXFT 14N80P		14	0.720	3900	61	250	0.31	400	X019	X017a TO-3P 
IXFQ 14N80P		14	0.720	3900	61	250	0.31	400	X017a	
IXFH 16N80P		16	0.600	4000	70	250	0.27	460	X014a	X019 TO-268AA 
IXFT 16N80P		16	0.600	4000	70	250	0.27	460	X019	
IXFR 32N80P		20	0.290	8800	150	250	0.42	300	X016a	X020a TO-264 
IXFH 20N80P		20	0.520	4685	86	250	0.25	500	X014a	
IXFT 20N80P		20	0.520	4685	86	250	0.25	500	X019	X021a PLUS264 
IXFH 24N80P		24	0.400	5800	100	250	0.19	650	X014a	
IXFK 24N80P		24	0.400	7200	105	250	0.19	650	X020a	X022a ISOPLUS264™ 
IXFT 24N80P		24	0.400	5800	100	250	0.19	650	X019	
IXFR 44N80P		26	0.190	12000	200	250	0.35	360	X016a	X027a SOT-227B miniBLOC 
IXFN 32N80P		29	0.270	8820	150	250	0.20	625	X027a	
IXFX 32N80P		32	0.270	8800	150	250	0.15	830	X015a	
IXFK 32N80P		32	0.270	8800	150	250	0.15	830	X020a	
IXFN 44N80P		39	0.190	18000	200	250	0.18	694	X027a	
IXFL 60N80P		40	0.150	18000	250	250	0.20	625	X022a	
IXFX 44N80P		44	0.190	12000	198	250	0.12	1200	X015a	
IXFK 44N80P		44	0.190	12000	198	250	0.12	1200	X020a	
IXFN 60N80P		53	0.140	18000	250	250	0.12	1040	X027a	
IXFB 60N80P		60	0.140	18000	250	250	0.10	1250	X021a	
IXFR 18N90P	900	10.5	0.660	5230	97	300	0.62	200	X016a	
IXFH 12N90P		12	0.900	3080	56	300	0.33	380	X014a	
IXFR 24N90P		13	0.460	7200	130	300	0.54	230	X016a	
IXFH 18N90P		18	0.600	5230	97	300	0.23	540	X014a	
IXFT 18N90P		18	0.600	5230	97	300	0.23	540	X019	
IXFR 40N90P		21	0.230	14000	230	300	0.42	300	X016a	
IXFH 24N90P		24	0.420	7200	130	300	0.19	660	X014a	
IXFT 24N90P		24	0.420	7200	130	300	0.19	660	X019	
IXFK 32N90P		32	0.300	10600	215	300	0.13	960	X020a	
IXFX 32N90P		32	0.300	10600	215	300	0.13	960	X015a	
IXFN 40N90P		33	0.210	14000	230	300	0.18	695	X027a	
IXFX 40N90P		40	0.210	14000	230	300	0.13	960	X015a	
IXFK 40N90P		40	0.210	14000	230	300	0.13	960	X020a	
IXFN 52N90P		43	0.160	19000	308	300	0.14	890	X027a	
IXFB 52N90P		52	0.160	19000	308	300	0.10	1250	X021a	
IXFN 56N90P		56	0.145	23000	375	300	0.125	1000	X027a	

Polar™ HiPerFET™ MOSFETs with Fast Intrinsic Diode

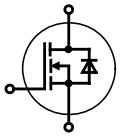

Part Type	V _{DSS} V	I _{D(cont)} Chip T _C = 25°C A	R _{DS(on)} T _J = 25°C Ω	C _{iss} typ pF	Q _g typ nC	t _{rr} typ ns	R _{thJC} K/W	P _D W	Fig. No.	Package style Outline drawings on pages O-36...O-59
IXFP 4N100P	1000	4	3.30	1456	26	300	0.83	150	X005a	X005a TO-220AB
IXFA 4N100P		4	3.30	1456	26	300	0.83	150	X011b	
IXFP 5N100P		5	2.80	1830	33.4	200	0.50	250	X005a	X011b TO-263AB
IXFH 5N100P		5	2.80	1830	33.4	200	0.50	250	X014a	
IXFA 5N100P		5	2.80	1830	33.4	200	0.50	250	X011b	X014a TO-247AD
IXFA 7N100P		7	1.90	2590	47	300	0.42	300	X011b	
IXFH 7N100P		7	1.90	2590	47	300	0.42	300	X014a	X015a PLUS247
IXFP 7N100P		7	1.90	2590	47	300	0.42	300	X005a	
IXFH 10N100P		10	1.40	3030	56	300	0.33	380	X014a	X016a ISOPLUS247™
IXFR 20N100P		11	0.64	7300	126	300	0.54	230	X016a	
IXFH 12N100P		12	1.05	4080	80	300	0.27	463	X014a	X019 TO-268AA
IXFR 26N100P		15	0.43	11900	197	300	0.43	290	X016a	
IXFH 15N100P		15	0.76	5140	97	300	0.23	543	X014a	X020a TO-264
IXFR 32N100P		18	0.34	14200	225	300	0.39	320	X016a	
IXFH 20N100P		20	0.57	7300	126	300	0.19	660	X014a	X021a PLUS264
IXFT 20N100P		20	0.57	7300	126	300	0.19	660	X019	
IXFL 44N100P		22	0.24	19000	305	300	0.35	357	X022e	X022a ISOPLUS264™
IXFN 26N100P		23	0.39	11900	197	300	0.21	595	X027a	
IXFX 26N100P		26	0.39	11900	197	300	0.16	780	X015a	X027a SOT-227B miniBLOC
IXFK 26N100P		26	0.39	11900	197	300	0.16	780	X020a	
IXFN 32N100P		27	0.32	14200	225	300	0.18	690	X027a	X027a
IXFL 38N100P		29	0.23	24000	350	300	0.24	520	X022e	
IXFX 32N100P		32	0.32	14200	225	300	0.13	960	X015a	X021a
IXFK 32N100P		32	0.32	14200	225	300	0.13	960	X020a	
IXFN 44N100P		37	0.22	19000	305	300	0.14	890	X027a	X020a
IXFN 38N100P		38	0.21	24000	350	300	0.125	1000	X027a	
IXFB 44N100P		44	0.22	19000	305	300	0.10	1250	X021a	X020a
IXFL 40N110P	1100	21	0.28	19000	310	300	0.35	357	X022e	
IXFL 36N110P		26	0.26	23000	350	300	0.24	520	X022e	X021a
IXFN 40N110P		34	0.26	19000	310	300	0.14	890	X027a	
IXFB 40N110P		40	0.26	19000	310	300	0.10	1250	X021a	X022a
IXFP 6N120P	1200	6	2.40	2830	92	300	0.50	250	X005a	
IXFH 6N120P		6	2.40	2830	92	300	0.50	250	X014a	X022e ISOPLUS264™
IXFA 6N120P		6	2.40	2830	92	300	0.50	250	X011b	
IXFR 16N120P		9	1.04	6900	120	300	0.54	230	X016a	X022e ISOPLUS264™
IXFH 12N120P		12	1.35	5400	103	300	0.23	543	X014a	
IXFR 20N120P		13	0.63	12900	193	300	0.43	290	X016a	X022e ISOPLUS264™
IXFR 26N120P		15	0.50	14000	225	300	0.39	320	X016a	
IXFH 16N120P		16	0.95	6900	120	300	0.19	660	X014a	X022e ISOPLUS264™
IXFT 16N120P		16	0.95	6900	120	300	0.19	660	X019	
IXFL 30N120P		18	0.38	19000	310	300	0.35	357	X022e	X022e ISOPLUS264™
IXFX 20N120P		20	0.57	11100	193	300	0.16	780	X015a	
IXFN 20N120P		20	0.57	11100	193	300	0.21	595	X027a	X027a
IXFK 20N120P		20	0.57	11100	193	300	0.16	780	X020a	
IXFN 26N120P		23	0.46	14000	225	300	0.18	695	X027a	X027a
IXFL 32N120P		24	0.34	21000	360	300	0.24	520	X022e	
IXFX 26N120P		26	0.46	14000	225	300	0.13	960	X015a	X027a
IXFK 26N120P		26	0.46	14000	225	300	0.13	960	X020a	
IXFB 30N120P		30	0.35	22500	310	300	0.10	1250	X021a	X027a
IXFN 30N120P		30	0.35	19000	310	300	0.14	890	X027a	
IXFN 32N120P		32	0.31	21000	360	300	0.125	1000	X027a	

PolarP2™ Power MOSFETs

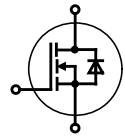







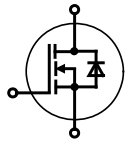

Part Type	V _{DSS} V	I _{D(cont)} Chip T _C = 25°C A	R _{DS(on)} T _J = 25°C Ω	C _{iss} typ. pF	Q _g typ. nC	t _{rr} typ. ns	R _{thJC} K/W	P _D W	Fig. No.	Package style Outline drawings on pages O-36...O-59	
PolarP2™ Standard Power MOSFETs										X005a	TO-220AB
IXTH 450P2	500	16	0.330	2530	43	400	0.42	300	X014a	X011b	TO-263AB
IXTP 450P2		16	0.330	2530	43	400	0.42	300	X005a		
IXTQ 450P2		16	0.330	2530	43	400	0.42	300	X017a	X014a	TO-247AD
IXTA 460P2		24	0.270	2890	48	400	0.26	480	X011b		
IXTH 460P2		24	0.270	2890	48	400	0.26	480	X014a	X014a	TO-247AD
IXTP 460P2		24	0.270	2890	48	400	0.26	480	X005a		
IXTQ 460P2		24	0.270	2890	48	400	0.26	480	X017a	X017a	TO-247AD
IXTQ 470P2		42	0.145	5400	88	400	0.15	830	X017a		
IXTQ 480P2		52	0.120	6800	108	400	0.13	960	X017a		
PolarP2™ HiPerFET™ MOSFETs with Fast Intrinsic Diode										X015a	PLUS247
IXFQ 24N50P2	500	24	0.270	2890	48	200	0.26	480	X017a	X016c	ISO247™
IXFH 42N50P2		42	0.145	5300	92	250	0.15	830	X014a		
IXFT 42N50P2		42	0.145	5300	92	250	0.15	830	X019	X017a	TO-3P
IXFH 52N50P2		52	0.120	6800	113	250	0.13	960	X014a		
IXFT 52N50P2		52	0.120	6800	113	250	0.13	960	X019	X017a	TO-3P
IXFN 94N50P2		68	0.055	13700	220	250	0.16	780	X027a		
IXFK 94N50P2		94	0.055	14200	228	250	0.10	1300	X020a	X017a	TO-3P
IXFX 94N50P2		94	0.055	14200	228	250	0.10	1300	X015a		
IXFB 120N50P2		120	0.043	19000	300	300	0.07	1890	X021a		

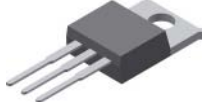
PolarP3™ HiPerFET™ Power MOSFETs

Part Type	V _{DSS} V	I _{D(cont)} Chip T _C = 25°C A	R _{DS(on)} T _J = 25°C Ω	C _{iss} typ. pF	Q _g typ. nC	t _{rr} max. (typ.) ns	R _{thJC} K/W	P _D W	Fig. No.	Package style Outline drawings on pages O-36...O-59	
IXFP 36N30P3	300	36	0.1100	2040	30	-125	0.36	347	X005a	X020a	TO-264
IXFA 36N30P3		36	0.1100	2040	30	-125	0.36	347	X011b		
IXFH 94N30P3		94	0.0360	5510	102	250	0.12	1040	X014a	X021a	PLUS264
IXFQ 94N30P3		94	0.0360	5510	102	250	0.12	1040	X017a		
IXFT 94N30P3		94	0.0360	5510	102	250	0.12	1040	X019	X022a	ISOPLUS264™
IXFL 210N30P3		108	0.0160	16200	268	250	0.24	520	X022a		
IXFK 120N30P3		120	0.0270	8630	150	250	0.11	1130	X020a	X022a	ISOPLUS264™
IXFX 120N30P3		120	0.0270	8630	150	250	0.11	1130	X015a		
IXFK 150N30P3		150	0.0190	12100	197	250	0.10	1300	X020a	X027a	SOT-227B miniBLOC
IXFX 150N30P3		150	0.0190	12100	197	250	0.10	1300	X015a		
IXFN 210N30P3		192	0.0145	16200	268	250	0.08	1500	X027a	X027a	SOT-227B miniBLOC
IXFB 210N30P3		210	0.0145	16200	268	250	0.07	1890	X021a		
IXFJ 26N50P3	500	14	0.2650	2220	42	250	0.69	180	X016c	X027a	SOT-227B miniBLOC
IXFA 16N50P3		16	0.3600	1515	29	250	0.38	330	X011b		
IXFH 16N50P3		16	0.3600	1515	29	250	0.38	330	X014a	X005a	SOT-227B miniBLOC
IXFP 16N50P3		16	0.3600	1515	29	250	0.38	330	X005a		
IXFA 20N50P3		20	0.3000	1800	36	250	0.36	380	X011b	X014a	SOT-227B miniBLOC
IXFH 20N50P3		20	0.3000	1800	36	250	0.36	380	X014a		
IXFP 20N50P3		20	0.3000	1800	36	250	0.36	380	X005a		

PolarP3™ HiPerFET™ Power MOSFETs

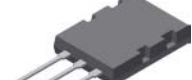

Part Type	V _{DSS} V	I _{D(cont)} Chip T _C = 25°C A	R _{DS(on)} T _J = 25°C Ω	C _{iss} typ. pF	Q _g typ. nC	t _{rr} typ. ns	R _{thJC} K/W	P _D W	Fig. No.	Package style Outline drawings on pages O-36...O-59	
IXFQ 20N50P3	500	20	0.300	1800	36	250	0.360	380	X017a	X005a TO-220AB 	
IXFA 26N50P3		26	0.230	2220	42	250	0.250	500	X011b		
IXFH 26N50P3		26	0.230	2220	42	250	0.250	500	X014a		
IXFP 26N50P3		26	0.230	2220	42	250	0.250	500	X005a	X011b TO-263AB 	
IXFQ 26N50P3		26	0.230	2220	42	250	0.250	500	X017a		
IXFH 34N50P3		34	0.170	3260	60	250	0.180	695	X014a		
IXFQ 34N50P3		34	0.170	3260	60	250	0.180	695	X017a		
IXFH 60N50P3		60	0.100	6250	96	250	0.120	1040	X014a	X014a TO-247AD 	
IXFQ 60N50P3		60	0.100	6250	96	250	0.120	1040	X017a		
IXFT 60N50P3		60	0.100	6250	96	250	0.120	1040	X019	X022a TO-247AD 	
IXFL 132N50P3	63	0.043	18600	18600	250	250	0.240	520	X022a		
IXFK 78N50P3	78	0.068	9900	9900	147	250	0.110	1130	X020a		
IXFX 78N50P3	78	0.068	9900	9900	147	250	0.110	1130	X015a		
IXFK 98N50P3	98	0.050	13100	13100	197	250	0.096	1300	X020a		
IXFX 98N50P3	98	0.050	13100	13100	197	250	0.096	1300	X015a		
IXFN 132N50P3	112	0.039	18600	18600	250	250	0.083	1500	X027a		
IXFB 132N50P3	132	0.039	18600	18600	250	250	0.066	1890	X021a		
IXFA 14N60P3	600	14	0.540	1480	25	250	0.380	327	X011b		X016a ISOPLUS247™ 
IXFH 14N60P3		14	0.540	1480	25	250	0.380	327	X014a		
IXFP 14N60P3		14	0.540	1480	25	250	0.380	327	X005a		
IXFA 16N60P3		16	0.440	1830	36	250	0.360	347	X011b	X017a TO-3P 	
IXFH 16N60P3		16	0.440	1830	36	250	0.360	347	X014a		
IXFP 16N60P3		16	0.440	1830	36	250	0.360	347	X005a	X019 TO-268AA 	
IXFA 22N60P3		22	0.360	2600	38	250	0.250	500	X011b		
IXFH 22N60P3		22	0.360	2600	38	250	0.250	500	X014a		
IXFP 22N60P3		22	0.360	2600	38	250	0.250	500	X005a		
IXFQ 22N60P3		22	0.360	2600	38	250	0.250	500	X017a	X020a TO-264 	
IXFH 28N60P3		28	0.260	3560	50	250	0.180	695	X014a		
IXFQ 28N60P3		28	0.260	3560	50	250	0.180	695	X017a	X021a PLUS264 	
IXFH 42N60P3		42	0.185	5150	78	250	0.150	830	X014a		
IXFR 80N60P3		48	0.076	13100	13100	190	250	0.230	540		X016a
IXFH 50N60P3		50	0.145	6300	6300	94	250	0.120	1040		X014a
IXFQ 50N60P3		50	0.145	6300	6300	94	250	0.120	1040		X017a
IXFT 50N60P3		50	0.145	6300	6300	94	250	0.120	1040		X019
IXFK 64N60P3		64	0.095	9900	9900	145	250	0.110	1130		X020a
IXFX 64N60P3		64	0.095	9900	9900	145	250	0.110	1130		X015a
IXFN 80N60P3		66	0.077	13100	13100	190	250	0.130	960		X027a
IXFK 80N60P3	80	0.070	13100	13100	190	250	0.096	1300	X020a		
IXFX 80N60P3	80	0.070	13100	13100	190	250	0.096	1300	X015a		
IXFN 110N60P3	90	0.056	18000	18000	245	250	0.083	1500	X027a	X022a ISOPLUS264™ 	
IXFB 110N60P3	110	0.056	18000	18000	245	250	0.066	1890	X021a		

X027a **SOT-227B miniBLOC**



X031a **SMPD-X**











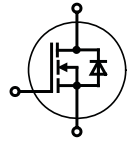



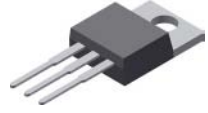







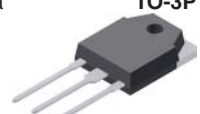
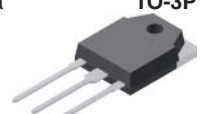

PolarP3™ Power MOSFET

with Current & Temperature Sensing in SMPD Package

Part Type	V _{DSS} V	I _{D(cont)} Chip T _C = 25°C A	R _{DS(on)} T _J = 25°C Ω	C _{iss} typ. pF	Q _g typ. nC	t _{rr} typ. ns	R _{thJC} K/W	P _D W	Fig. No.
MMIX 1T132N50P3	500	63	0.043	18600	267	600	0.24	520	X031a







Ultra Junction Power MOSFETs

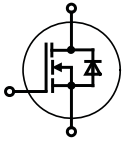

Part Type	V _{DSS}	I _{D(cont)} Chip T _C = 25°C	R _{DS(on)} T _J = 25°C	C _{iss}	Q _g	t _{rr}	R _{thJC}	P _D	Fig. No.	Package style	
➤ New	V	A	Ω	pF	nC	ns	K/W	W		Outline drawings on pages O-36...O-59	
135 V Ultra Junction X4-Class Power MOSFETs										X004	TO-252AA
➤ IXTP 170N13X4	135	170	0.0063	5460	105	86	0.31	480	X005a		
150 V Ultra Junction X4-Class Power MOSFETs										X005a	TO-220AB
➤ IXTA 100N15X4	150	100	0.0115	3970	74	90	0.40	375	X011b		
➤ IXTP 100N15X4		100	0.0115	3970	74	90	0.40	375	X005a		
➤ IXTH 130N15X4		130	0.0085	4770	87	93	0.31	400	X014a		
➤ IXTP 130N15X4		130	0.0085	4770	87	93	0.31	400	X005a		
➤ IXTA 130N15X4		130	0.0080	4770	87	93	0.31	400	X011b		
➤ IXTA 130N15X4-7		130	0.0080	4770	87	93	0.31	400	X012c		
➤ IXTH 150N15X4		150	0.0072	5500	105	100	0.31	480	X014a		
➤ IXTP 150N15X4		150	0.0072	5500	105	100	0.31	480	X005a		
➤ IXTA 150N15X4		150	0.0069	5500	105	100	0.31	480	X011b		
➤ IXTA 150N15X4-7		150	0.0069	5500	105	100	0.31	480	X012c		
➤ IXTH 240N15X4		240	0.0044	8900	195	130	0.16	940	X014a		
➤ IXTT 240N15X4HV		240	0.0044	8900	195	130	0.16	940	X019a		
➤ IXTK 400N15X4		400	0.0031	14500	430	175	0.10	1500	X020a		
➤ IXTN 400N15X4		400	0.0031	14500	430	175	0.14	1070	X027a		
➤ IXTX 400N15X4		400	0.0031	14500	430	175	0.10	1500	X015a		
200 V X3-Class HiPerFET™ Power MOSFETs with Fast Body Diodes										X014a	TO-247AD
IXFA 36N20X3	200	36	0.0450	1425	21	75	0.73	170	X011b		
IXFP 36N20X3		36	0.0450	1425	21	75	0.73	170	X005a		
IXFP 36N20X3M		36	0.0450	1425	21	75	3.50	36	X007a		
IXFY 36N20X3		36	0.0450	1425	21	75	0.73	170	X004		
IXFA 50N20X3		50	0.0300	2100	33	70	0.52	240	X011b		
IXFP 50N20X3		50	0.0300	2100	33	70	0.52	240	X005a		
IXFP 50N20X3M		50	0.0300	2100	33	70	3.70	34	X007a		
IXFA 72N20X3		72	0.0200	3780	55	95	0.39	320	X011b		
IXFP 72N20X3		72	0.0200	3780	55	95	0.39	320	X005a		
IXFP 72N20X3M		72	0.0200	3780	55	95	3.50	36	X007a		
IXFQ 72N20X3		72	0.0200	3780	55	95	0.39	320	X017a		
IXFA 90N20X3		90	0.0128	5420	78	95	0.32	390	X011b		
IXFH 90N20X3		90	0.0128	5420	78	95	0.32	390	X014a		
IXFP 90N20X3		90	0.0128	5420	78	95	0.32	390	X005a		
IXFP 90N20X3M		90	0.0128	5420	78	95	3.50	36	X007a		
IXFQ 90N20X3		90	0.0128	5420	78	95	0.32	390	X017a		
IXFH 140N20X3		140	0.0096	7660	127	105	0.26	480	X014a		
IXFQ 140N20X3		140	0.0096	7660	127	105	0.26	480	X017a		
IXFT 140N20X3HV		140	0.0096	7660	127	105	0.26	480	X019a		
IXFN 220N20X3		160	0.0062	13600	204	128	0.32	390	X027a		
IXFH 180N20X3		180	0.0075	10300	154	120	0.17	735	X014a		
IXFT 180N20X3HV		180	0.0075	10300	154	120	0.17	735	X019a		
IXFH 220N20X3		220	0.0062	13600	204	128	0.14	890	X014a		
IXFK 220N20X3		220	0.0062	13600	204	128	0.14	890	X020a		
IXFT 220N20X3HV		220	0.0062	13600	204	128	0.14	890	X019a		
IXFK 300N20X3		300	0.0040	23800	375	172	0.10	1250	X020a		
IXFN 300N20X3		300	0.0035	23800	375	172	0.18	695	X027a		
IXFX 300N20X3		300	0.0040	23800	375	172	0.10	1250	X015a		

Ultra Junction Power MOSFETs



Part Type	V _{DSS}	I _{D(cont)} Chip T _C = 25°C	R _{DS(on)} T _J = 25°C	C _{iss} typ.	Q _g typ.	t _{rr} typ.	R _{thJC}	P _D	Fig. No.	Package style	
➤ New	V	A	Ω	pF	nC	ns	K/W	W		Outline drawings on pages O-36...O-59	
250 V X3-Class HiPerFET™ Power MOSFETs with Fast Body Diodes										X004	TO-252AA
IXFA 30N25X3	250	30	0.0600	1450	21	82	0.73	170	X011b		
IXFP 30N25X3		30	0.0600	1450	21	82	0.73	170	X005a		
IXFP 30N25X3M		30	0.0600	1450	21	82	3.50	36	X007a		
IXFY 30N25X3		30	0.0600	1450	21	82	0.73	170	X004		
IXFA 44N25X3		44	0.0400	2200	33	87	0.52	240	X011b	X005a	TO-220AB
IXFJ 80N25X3		44	0.0180	5430	83	120	1.20	104	X016c		
IXFP 44N25X3		44	0.0400	2200	33	87	0.52	240	X005a		
IXFP 44N25X3M		44	0.0400	2220	33	87	3.70	34	X007a		
IXFA 60N25X3		60	0.0230	3610	50	95	0.39	320	X011b		
IXFP 60N25X3		60	0.0230	3610	50	95	0.39	320	X005a		
IXFP 60N25X3M		60	0.0230	3610	50	95	3.50	36	X007a	X007a	TO-220FPAB
IXFQ 60N25X3		60	0.0230	3610	50	95	0.39	320	X017a		
IXFA 80N25X3		80	0.0160	5430	83	120	0.32	390	X011b		
IXFH 80N25X3		80	0.0160	5430	83	120	0.32	390	X014a		
IXFP 80N25X3		80	0.0160	5430	83	120	0.32	390	X005a		
IXFQ 80N25X3		80	0.0160	5430	83	120	0.32	390	X017a	X011b	TO-263AB
IXFH 120N25X3		120	0.0120	7870	122	140	0.26	480	X014a		
IXFQ 120N25X3		120	0.0120	7870	122	140	0.26	480	X017a		
IXFT 120N25X3HV		120	0.0120	7870	122	140	0.26	480	X019a		
IXFH 150N25X3		150	0.0090	10400	154	140	0.17	735	X014a	X014a	TO-247AD
IXFT 150N25X3HV		150	0.0090	10400	154	140	0.17	735	X019a		
IXFH 170N25X3		170	0.0074	13500	190	140	0.14	890	X014a		
IXFK 170N25X3		170	0.0074	13500	190	140	0.14	890	X020a		
IXFN 170N25X3		170	0.0074	13500	190	135	0.32	390	X027a		
IXFT 170N25X3HV		170	0.0074	13500	190	140	0.14	890	X019a		
IXFK 240N25X3		240	0.0050	23800	345	177	0.10	1250	X020a	X015a	PLUS247
IXFN 240N25X3		240	0.0045	23800	345	165	0.18	695	X027a		
IXFX 240N25X3		240	0.0050	23800	345	177	0.10	1250	X015a		

X020a **TO-264**



X019a **TO-268AAHV**

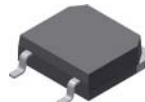

X016c **ISO247™**









X027a **SOT-227B miniBLOC**

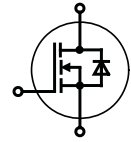

X017a **TO-3P**





Part Type	V _{DSS}	I _{D(cont)} Chip T _C = 25°C	R _{DS(on)} T _J = 25°C	C _{iss}	Q _g	t _{rr}	R _{thJC}	P _D	Fig. No.	Package style	
➤ New	V	A	Ω	typ. pF	typ. nC	typ. ns	K/W	W		Outline drawings on pages O-36...O-59	
300 V X3-Class HiPerFET™ Power MOSFETs with Fast Body Diodes											
IXFA 26N30X3	300	26	0.0660	1465	22	105	0.73	170	X011b	X004	TO-252AA 
IXFP 26N30X3		26	0.0660	1465	22	105	0.73	170	X005a		
IXFY 26N30X3		26	0.0660	1465	22	105	0.73	170	X004		
IXFA 38N30X3	38	38	0.0500	2240	35	90	0.52	240	X011b	X005a	TO-220AB 
IXFP 38N30X3		38	0.0500	2240	35	90	0.52	240	X005a		
IXFP 38N30X3M		38	0.0500	2440	35	90	3.70	34	X007a		
IXFA 56N30X3	56	56	0.0270	3750	56	115	0.39	320	X011b	X007a	TO-220FPAB 
IXFH 56N30X3		56	0.0270	3750	56	115	0.39	320	X014a		
IXFP 56N30X3		56	0.0270	3750	56	115	0.39	320	X005a		
IXFP 56N30X3M	56	0.0270	3750	56	115	3.50	36	X007a			
IXFA 72N30X3	72	72	0.0190	5400	82	100	0.32	390	X011b	X007a	TO-263AB 
IXFH 72N30X3		72	0.0190	5400	82	100	0.32	390	X014a		
IXFP 72N30X3		72	0.0190	5400	82	100	0.32	390	X005a		
IXFP 72N30X3M	72	0.0190	5400	82	100	3.50	36	X007a			
IXFQ 72N30X3	72	0.0190	5400	82	100	0.32	390	X017a			
IXFH 100N30X3	100	100	0.0135	7660	122	130	0.26	48	X014a	X011b	TO-247AD 
IXFT 100N30X3HV		100	0.0135	7660	122	130	0.26	480	X019a		
IXFH 120N30X3		120	0.0110	10500	170	145	0.17	735	X014a		
IXFT 120N30X3HV	120	0.0110	10500	170	145	0.17	735	X019a			
IXFH 150N30X3	150	150	0.0083	13100	254	167	0.14	890	X014a	X011b	PLUS247 
IXFK 150N30X3		150	0.0083	13100	254	167	0.14	890	X020a		
IXFT 150N30X3HV		150	0.0083	13100	254	167	0.14	890	X019a		
IXFK 210N30X3	210	0.0055	24200	375	190	0.10	1250	X020a			
IXFN 210N30X3	210	0.0046	24200	375	190	0.18	695	X027a			
IXFX 210N30X3	210	0.0055	24200	375	190	0.10	1250	X015a			

X014a **TO-247AD**



X015a **PLUS247**



X027a **SOT-227B miniBLOC**



X017a **TO-3P**



X019a **TO-268AAHV**





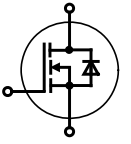





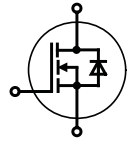

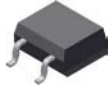
Ultra Junction Power MOSFETs



Part Type	V _{DSS}	I _{D(cont)} Chip T _C = 25°C	R _{DS(on)} T _J = 25°C	C _{iss} typ.	Q _g typ.	t _{rr} typ.	R _{thJC}	P _D	Fig. No.	Package style	
➤ New	V	A	Ω	pF	nC	ns	K/W	W		Outline drawings on pages O-36...O-59	
650 V X2-Class Power MOSFETs										X004	TO-252AA
IXTP 2N65X2	650	2	2.300	180	4.3	137	2.27	55	X005a		
IXTY 2N65X2		2	2.300	180	4.3	137	2.27	55	X004		
IXTA 4N65X2		4	0.850	455	8.3	160	1.56	80	X011b		
IXTP 4N65X2		4	0.850	455	8.3	160	1.56	80	X005a	X005a	TO-220AB
IXTY 4N65X2		4	0.850	455	8.3	160	1.56	80	X004		
IXTA 8N65X2		8	0.500	800	12	200	0.83	150	X011b		
IXTP 8N65X2		8	0.500	800	12	200	0.83	150	X005a		
IXTP 8N65X2M		8	0.550	800	12	200	3.90	32	X007a	X007a	TO-220FPAB
IXTY 8N65X2		8	0.500	800	12	200	0.83	150	X004		
IXTA 12N65X2		12	0.300	1100	17.7	270	0.69	180	X011b		
IXTH 12N65X2		12	0.300	1100	17.7	270	0.69	180	X014a	X011b	TO-263AB
IXTP 12N65X2		12	0.300	1100	17.7	270	0.69	180	X005a		
IXTP 12N65X2M		12	0.300	1100	17.7	270	3.10	40	X007a		
IXTA 20N65X2		20	0.185	1450	27	350	0.43	290	X011b		
IXTH 20N65X2		20	0.185	1450	27	350	0.43	290	X014a	X014a	TO-247AD
IXTP 20N65X2		20	0.185	1450	27	350	0.43	290	X005a		
IXTP 20N65X2M		20	0.185	1450	27	350	3.50	36	X007a		
IXTA 24N65X2		24	0.145	2060	36	390	0.32	390	X011b		
IXTH 24N65X2		24	0.145	2060	36	390	0.32	390	X014a	X014a	PLUS247
IXTP 24N65X2		24	0.145	2060	36	390	0.32	390	X005a		
IXTP 24N65X2M		24	0.145	2060	36	390	3.37	37	X007a		
IXTA 30N65X2		30	0.120	2260	44	355	0.27	460	X011b		
IXTP 30N65X2		30	0.120	2260	44	355	0.27	460	X014a	X016a	ISOPLUS247™
IXTH 30N65X2		30	0.120	2260	44	355	0.27	460	X014a		
IXTA 34N65X2		34	0.096	3000	54	390	0.23	540	X011b		
IXTA 34N65X2		34	0.096	3000	54	390	0.23	540	X011b		
IXTH 34N65X2		34	0.096	3000	54	390	0.23	540	X014a	X019a	TO-268AAHV
IXTP 34N65X2		34	0.096	3000	54	390	0.23	540	X005a		
IXTT 34N65X2HV		34	0.096	3000	54	390	0.23	540	X019a		
IXTH 48N65X2		48	0.065	4300	76	400	0.19	660	X014a	X020a	TO-264
IXTR 102N65X2		54	0.033	10900	152	450	0.38	330	X016a		
IXTH 62N65X2		62	0.050	5800	100	445	0.16	780	X014a		
IXTN 102N65X2		76	0.030	10900	152	450	0.21	595	X027a		
IXTH 80N65X2		80	0.038	7800	137	465	0.14	890	X014a	X027a	SOT-227B miniBLOC
IXTK 102N65X2		102	0.030	10900	152	450	0.12	1040	X020a		
IXTX 102N65X2		102	0.030	10900	152	450	0.12	1040	X015a		
IXTK 120N65X2		120	0.023	13600	230	505	0.10	1250	X020a		
IXTX 120N65X2		120	0.023	13600	230	505	0.10	1250	X015a		









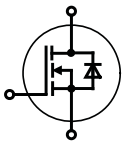



Ultra Junction Power MOSFETs



Part Type	V _{DSS} V	I _{D(cont)} Chip T _C = 25°C A	R _{DS(on)} T _J = 25°C Ω	C _{iss} typ. pF	Q _g typ. nC	t _{rr} typ. ns	R _{thJC} K/W	P _D W	Fig. No.	Package style Outline drawings on pages O-36...O-59	
650 V X2-Class HiPerFET™ Power MOSFETs with Fast Body Diodes										X004	TO-252AA 
IXFA 8N65X2	650	8	0.450	790	11	105	0.83	150	X011b		
IXFP 8N65X2		8	0.450	790	11	105	0.83	150	X005a		
IXFY 8N65X2		8	0.450	790	11	105	0.83	150	X004	X005a	TO-220AB 
IXFA 12N65X2		12	0.310	1134	18.5	155	0.69	180	X011b		
IXFH 12N65X2		12	0.310	1134	18.5	155	0.69	180	X014a		
IXFP 12N65X2		12	0.310	1134	18.5	155	0.69	180	X005a		
IXFP 12N65X2M		5.6	0.310	1134	18.5	155	3.10	40	X007a	X007a	TO-220FPAB 
IXFA 18N65X2		18	0.200	1520	29	135	0.43	290	X011b		
IXFH 18N65X2		18	0.200	1520	29	135	0.43	290	X014a		
IXFP 18N65X2		18	0.200	1520	29	135	0.43	290	X005a	X011b	TO-263AB 
IXFP 18N65X2M		18	0.200	1520	29	135	3.50	36	X007a		
IXFA 22N65X2		22	0.145	2190	37	145	0.32	390	X011b		
IXFH 22N65X2		22	0.145	2190	37	145	0.32	390	X014a		
IXFP 22N65X2		22	0.145	2190	37	145	0.32	390	X005a	X014a	TO-247AD 
IXFP 22N65X2M		22	0.145	2190	37	145	3.37	37	X007a		
IXFA 34N65X2		34	0.100	3230	56	164	0.23	540	X011b		
IXFH 34N65X2		34	0.100	3230	56	164	0.23	540	X014a		
IXFP 34N65X2		34	0.100	3230	56	164	0.23	540	X005a	X015a	PLUS247 
IXFP 34N65X2M		34	0.100	3230	56	164	3.10	40	X007a		
IXFH 46N65X2		46	0.069	4570	98	180	0.19	660	X014a		
IXFH 60N65X2		60	0.052	6300	108	180	0.16	780	X014a		
IXFH 60N65X2-4		60	0.052	6300	108	180	0.16	780	X014d	X019a	TO-268AAHV 
IXFT 60N65X2HV		60	0.052	6300	108	180	0.16	780	X019a		
IXFN 100N65X2		78	0.030	10800	183	200	0.21	595	X027a		
IXFH 80N65X2		80	0.038	8300	140	200	0.14	890	X014a	X020a	TO-264 
IXFH 80N65X2-4		80	0.038	8300	140	200	0.14	890	X014d		
IXFK 80N65X2		80	0.038	8300	140	200	0.14	890	X020a		
IXFT 80N65X2HV		80	0.038	8300	140	200	0.14	890	X019a		
IXFK 100N65X2		100	0.030	10800	183	200	0.12	1040	X020a	X021a	PLUS264 
IXFX 100N65X2		100	0.030	10800	183	200	0.12	1040	X015a		
IXFN 120N65X2		108	0.024	14000	240	220	0.14	890	X027a		
IXFK 120N65X2		120	0.024	14000	240	220	0.10	1250	X020a		
IXFX 120N65X2		120	0.024	14000	240	220	0.10	1250	X015a	X027a	SOT-227B miniBLOC 
IXFN 150N65X2		145	0.017	21000	355	260	0.12	1040	X027a		
IXFB 150N65X2		150	0.017	21000	355	260	0.08	1560	X021a		
IXFN 170N65X2		170	0.013	27000	434	270	0.107	1170	X027a		
IXFN 170N65X2		170	0.013	27000	434	270	0.107	1170	X027a		



Ultra Junction Power MOSFETs

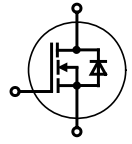

Part Type	V _{DSS}	I _{D(cont)} Chip T _C = 25°C	R _{DS(on)} T _J = 25°C	C _{iss} typ.	Q _g typ.	t _{rr} typ.	R _{thJC}	P _D	Fig. No.	Package style
➤ New	V	A	Ω	pF	nC	ns	K/W	W		Outline drawings on pages O-36...O-59
700 V X2-Class Power MOSFETs										
IXTA 4N70X2	700	4	0.850	386	11.8	186	1.56	80	X011b	X003 TO-251AA 
IXTP 4N70X2		4	0.850	386	11.8	186	1.56	80	X005a	
IXTP 4N70X2M		4	0.850	386	11.8	186	4.16	30	X007a	X004 TO-252AA 
IXTU 4N70X2		4	0.850	386	11.8	186	1.56	80	X003	
IXTY 4N70X2		4	0.850	386	11.8	186	1.56	80	X004	X005a TO-220AB 
IXTA 8N70X2		8	0.500	800	12	200	0.83	150	X011b	
IXTP 8N70X2		8	0.500	800	12	200	0.83	150	X005a	X007a TO-220FPAB 
IXTP 8N70X2M		8	0.550	800	12	200	3.90	32	X007a	
IXTU 8N70X2		8	0.500	800	12	200	0.83	150	X003	X011b TO-263AB 
IXTY 8N70X2		8	0.500	800	12	200	0.83	150	X004	
IXTA 12N70X2		12	0.300	960	19	270	0.69	180	X011b	X011c TO-263ABHV 
IXTH 12N70X2		12	0.300	960	19	270	0.69	180	X014a	
IXTP 12N70X2		12	0.300	960	19	270	0.69	180	X005a	X014a TO-247AD 
IXTP 12N70X2M		12	0.300	960	19	270	3.10	40	X007a	
850 V X-Class HiPerFET™ Power MOSFETs with Fast Body Diodes										
IXFA 4N85X	850	3.5	2.500	247	7	170	0.830	150	X011b	X011b TO-263AB 
IXFP 4N85X		3.5	2.500	247	7	170	0.830	150	X005a	
IXFP 4N85XM		3.5	2.500	247	7	170	3.570	35	X007a	X011c TO-263ABHV 
IXFY 4N85X		3.5	2.500	247	7	170	0.830	150	X004	
IXFA 8N85XHV		8	0.850	654	17	125	0.630	200	X011c	X014a TO-247AD 
IXFP 8N85X		8	0.850	654	17	125	0.630	200	X005a	
IXFP 8N85XM		8	0.850	654	17	125	3.780	33	X007a	X015a PLUS247 
IXFQ 8N85X		8	0.850	654	17	125	0.630	200	X017a	
IXFJ 20N85X		9.5	0.360	1660	63	190	1.130	110	X016c	X016c ISO247™ 
IXFA 14N85XHV		14	0.550	1043	30	116	0.270	460	X011c	
IXFH 14N85X		14	0.550	1043	30	116	0.270	460	X014a	X017a TO-3P 
IXFP 14N85X		14	0.550	1043	30	116	0.270	460	X005a	
➤ IXFP 14N85XM		14	0.550	1043	30	116	3.300	38	X007a	
IXFA 20N85XHV		20	0.330	1660	63	190	0.230	540	X011c	
IXFH 20N85X		20	0.330	1660	63	190	0.230	540	X014a	
IXFP 20N85X		20	0.330	1660	63	190	0.230	540	X005a	
IXFH 30N85X		30	0.230	2460	68	160	0.180	695	X014a	
IXFT 30N85XHV		30	0.230	2460	68	160	0.180	695	X019a	
IXFH 40N85X		40	0.145	3700	98	200	0.145	860	X014a	
IXFT 40N85XHV		40	0.145	3700	98	200	0.145	860	X019a	
IXFH 50N85X		50	0.105	4480	152	218	0.140	890	X014a	
IXFK 50N85X		50	0.105	4480	152	218	0.140	890	X020a	
IXFT 50N85XHV		50	0.105	4480	152	218	0.140	890	X019a	
IXFN 66N85X		65	0.065	8900	230	250	0.150	830	X027a	
IXFK 66N85X		66	0.065	8900	230	250	0.100	1250	X020a	
IXFX 66N85X		66	0.065	8900	230	250	0.100	1250	X015a	
IXFB 90N85X		90	0.041	13300	340	250	0.070	1785	X021a	
IXFN 90N85X		90	0.041	13300	340	250	0.104	1200	X027a	
IXFN 110N85X		110	0.033	17000	425	205	0.107	1170	X027a	

Ultra Junction Power MOSFETs



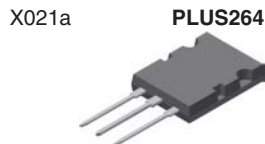
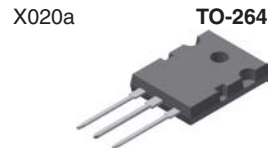

Part Type	V _{DSS}	I _{D(cont)} Chip T _C = 25°C	R _{DS(on)} T _J = 25°C	C _{iss}	Q _g	t _{rr}	R _{thJC}	P _D	Fig. No.	Package style
➤ New	V	A	Ω	typ. pF	typ. nC	typ. ns	K/W	W		Outline drawings on pages O-36...O-59
1000 V X-Class HiPerFET™ Power MOSFETs with Fast Body Diodes										
➤ IXFH 26N100X	1000	26	0.320	3290	113	220	0.145	860	X014a	X014a TO-247AD 
➤ IXFT 26N100XHV		26	0.320	3290	113	220	0.145	860	X019a	
➤ IXFH 32N100X		32	0.220	4075	130	200	0.140	890	X014a	
➤ IXFK 32N100X		32	0.220	4075	130	200	0.140	890	X020a	
➤ IXFT 32N100XHV		32	0.220	4075	130	200	0.140	890	X019a	
➤ IXFN 52N100X		44	0.125	6725	245	260	0.150	830	X027a	
➤ IXFK 52N100X		52	0.125	6725	245	260	0.100	1250	X020a	
➤ IXFX 52N100X		52	0.125	6725	245	260	0.100	1250	X015a	
➤ IXFN 70N100X		65	0.089	9150	350	310	0.104	1200	X027a	X015a PLUS247 
➤ IXFB 70N100X		70	0.089	9160	350	310	0.070	1785	X021a	
➤ IXFN 74N100X		74	0.066	17000	425	290	0.107	1170	X027a	



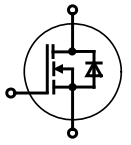

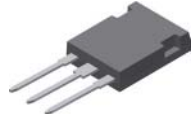

Q3-Class HiPerFET™ Power MOSFETs

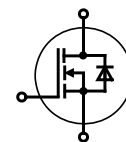

Part Type	V_{DSS}	$I_{D(cont)}$ Chip	$R_{DS(on)}$	C_{iss}	Q_g	t_{rr}	R_{thJC}	P_D	Fig. No.	Package style Outline drawings on pages O-36...O-59
	V	$T_C = 25^\circ C$ A	$T_J = 25^\circ C$ Ω	typ. pF	typ. nC	max. (typ.) ns	K/W	W		
IXFH 70N20Q3 IXFT 70N20Q3	200	70	0.040	3150	67	250	0.18	690	X014a X019	X014a TO-247AD 
IXFH 50N30Q3 IXFT 50N30Q3 IXFT 70N30Q3 IXFH 70N30Q3	300	50 50 70 70	0.080 0.080 0.054 0.054	3160 3160 4735 4735	65 65 98 98	250 250 250 250	0.18 0.18 0.15 0.15	690 690 830 830	X014a X019 X019 X014a	
IXFR 44N50Q3 IXFT 30N50Q3 IXFH 30N50Q3 IXFH 44N50Q3 IXFT 44N50Q3	500	25 30 30 44 44	0.154 0.200 0.200 0.140 0.140	4800 3200 3200 4800 4800	93 62 62 93 93	250 250 250 250 250	0.41 0.18 0.18 0.15 0.15	300 690 690 830 830	X016a X019 X014a X014a X019	X015a PLUS247 
IXFR 64N50Q3 IXFR 80N50Q3 IXFN 80N50Q3 IXFK 64N50Q3 IXFX 64N50Q3 IXFX 80N50Q3 IXFK 80N50Q3 IXFN 100N50Q3 IXFB 100N50Q3		45 50 63 64 64 80 80 82 100	0.094 0.072 0.065 0.085 0.085 0.065 0.065 0.049 0.049	6950 10000 10000 6950 6950 10000 10000 13800 13800	145 200 200 145 145 200 200 255 255	250 250 250 250 250 250 250 250 250	0.25 0.22 0.16 0.13 0.13 0.10 0.10 0.13 0.08	500 570 780 1000 1000 1250 1250 960 1560	X016a X016a X027a X020a X015a X015a X020a X027a X021a	
IXFR 48N60Q3 IXFR 64N60Q3 IXFK 48N60Q3 IXFX 48N60Q3 IXFK 64N60Q3 IXFX 64N60Q3 IXFN 82N60Q3 IXFB 82N60Q3	600	32 42 48 48 64 64 66 82	0.154 0.104 0.140 0.140 0.095 0.095 0.075 0.075	7020 9930 7020 7020 9930 9930 13500 13500	140 190 140 140 190 190 275 275	300 300 300 300 300 300 300 300	0.25 0.22 0.13 0.13 0.10 0.10 0.13 0.08	500 568 1000 1000 1250 1250 960 1560	X016a X016a X020a X015a X020a X015a X027a X021a	X019 TO-268AA 
IXFR 32N80Q3 IXFK 32N80Q3 IXFX 32N80Q3 IXFN 44N80Q3 IXFX 44N80Q3 IXFK 44N80Q3 IXFN 62N80Q3 IXFB 62N80Q3	800	24 32 32 37 44 44 49 62	0.300 0.270 0.270 0.190 0.190 0.190 0.140 0.140	6940 6940 6940 10950 10950 10950 13600 13600	140 140 140 185 185 185 270 270	300 300 300 300 300 300 300 300	0.25 0.125 0.125 0.16 0.10 0.10 0.13 0.08	500 1000 1000 780 1250 1250 960 1560	X016a X020a X015a X027a X015a X020a X027a X021a	
IXFR 15N100Q3 IXFT 15N100Q3 IXFH 15N100Q3 IXFH 18N100Q3 IXFT 18N100Q3 IXFR 24N100Q3 IXFR 32N100Q3 IXFK 24N100Q3 IXFX 24N100Q3 IXFN 32N100Q3 IXFK 32N100Q3 IXFX 32N100Q3 IXFN 44N100Q3 IXFB 44N100Q3	1000	10 15 15 18 18 18 23 24 24 28 32 32 38 44	1.200 1.050 1.050 0.660 0.660 0.490 0.350 0.440 0.440 0.320 0.320 0.320 0.220 0.220	3250 3250 3250 4890 4890 7200 10900 7200 7200 10900 10900 10900 13600 13600	64 64 64 90 90 140 195 140 140 195 195 195 264 264	250 250 250 300 300 300 300 300 300 300 250 250 250 300 300	0.31 0.18 0.18 0.15 0.15 0.25 0.22 0.125 0.125 0.16 0.10 0.10 0.10 0.13 0.08	400 690 690 830 830 500 570 1000 1000 780 1250 1250 1250 960 1560	X016a X019 X014a X014a X019 X016a X016a X020a X015a X027a X020a X015a X027a X021a	X021a PLUS264 
IXFN 40N110Q3 IXFB 40N110Q3	1100	35 40	0.260 0.260	14000 14000	300 300	-434 -434	0.13 0.08	960 1560	X027a X021a	

Very High Voltage Power MOSFETs (2 - 4.7 kV)

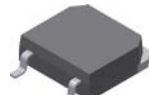

Part Type	V _{DSS} V	I _{D(cont)} Chip T _C = 25°C A	R _{DS(on)} T _J = 25°C Ω	C _{iss} typ. pF	Q _g typ. nC	t _{rr} typ. ns	R _{thJC} K/W	P _D W	Fig. No.	Package style Outline drawings on pages O-36...O-59
IXTH 1N200P3	2000	1	40	646	23.5	2300	1.00	125	X014a	X011c TO-263ABHV 
IXTH 1N200P3HV		1	40	646	23.5	2300	1.00	125	X014c	
IXTA 1N200P3HV		1	40	646	23.5	2300	1.00	125	X011c	
IXTH 3N200P3HV		3	8	1860	70	420	0.24	520	X014c	
IXTT 3N200P3HV		3	8	1860	70	420	0.24	520	X019a	
IXTF 6N200P3		4	4.2	3700	143	520	0.58	215	X024c	
IXTX 6N200P3HV	6	4	3700	143	520	0.13	960	X015c	X014a TO-247AD 	
IXTH 06N220P3HV	2200	0.6	80	290	10.4	1100	1.20	104		X014c
IXTH 1R8N220P3HV	1.8	21.5	965	31	1300	0.64	194	X014c		
IXTA 02N250HV	2500	0.2	450	116	7.4	1500	1.50	83		X011c
IXTH 02N250	0.2	450	116	7.4	1500	1.50	83	X014a		
IXTH 05N250P3HV	0.5	110	303	10.5	1200	1.20	104	X014c		
IXTF 1N250	1	40	1660	41	2500	1.13	110	X024c	X014c TO-247HV 	
IXTH 1R4N250P3	1.4	28	960	33	1800	0.64	195	X014a		
IXTH 1N250	1.5	40	1660	41	2500	0.50	250	X014a		
IXTT 1N250HV	1.5	40	1660	41	2500	0.50	250	X019a		
IXTN 5N250	5	8.8	8560	200	1200	0.18	700	X027a		
IXTK 5N250	5	8.8	8560	200	1200	0.13	960	X020a		
IXTX 5N250	5	8.8	8560	200	1200	0.13	960	X015a	X015a PLUS247 	
IXTH 04N300P3HV	3000	0.4	190	283	13	1100	1.20	104		X014c
IXTT 1N300P3HV	1	50	895	30.6	1800	0.64	195	X019a		
IXTH 1N300P3HV	1	50	895	30.6	1800	0.64	195	X014c		
IXTF 2N300P3	1.6	21	1890	73	400	0.77	160	X024c		
IXTH 2N300P3HV	2	21	1890	73	400	0.24	520	X014c		
IXTT 2N300P3HV	2	21	1890	73	400	0.24	520	X019a	X015c PLUS247HV 	
IXTX 4N300P3HV	4	12.5	3680	139	420	0.13	960	X015c		
IXTH 02N450HV	4500	0.2	625	246	10.6	1600	1.10	113		X014c
IXTF 02N450	0.2	625	246	10.6	1600	1.60	78	X024c		
IXTT 02N450HV	0.2	625	246	10.6	1600	1.10	113	X019a		
IXTF 1N450	0.9	80	1700	46	1750	0.77	165	X024c		
IXTT 1N450HV	1	80	1700	46	1750	0.24	520	X019a	X019a TO-268AAHV 	
IXTH 1N450HV	1	80	1700	46	1750	0.24	520	X014c		
IXTF 1R4N450	1.4	40	3300	88	660	0.65	190	X024c		
IXTX 1R4N450HV	1.4	40	3300	88	660	0.13	960	X015c		
IXTL 2N450	2	20	6860	180	1750	0.56	220	X022e		
IXTL 2N470	4700	2	20	6860	180	1750	0.56	220		X022e

X027a **SOT-227B miniBLOC**



X024c **ISOPLUS i4-PAC™**

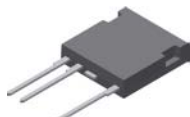

X022e **ISOPLUS264/i5-Pak**

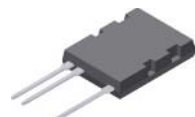



X020a **TO-264**

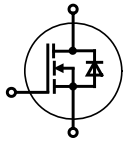

Legacy (Standard) Power MOSFETs



Part Type	V _{DSS} V	I _{D(Cont)} Chip T _C = 25°C A	R _{DS(on)} T _J = 25°C Ω	C _{iss} typ. pF	Q _g typ. nC	t _{rr} typ. ns	R _{thJC} K/W	P _D W	Fig. No.	Package style Outline drawings on pages O-36...O-59
IXTA 05N100HV	1000	0.75	17	260	7.8	710	3.10	40	X011c	X005a TO-220AB 
IXTP 3N120	1200	3.00	4.5	1050	39	700	0.62	200	X005a	
IXTH 3N120		3.00	4.5	1050	39	700	0.80	100	X014a	
IXTA 3N120		3.00	4.5	1050	39	700	0.62	200	X011b	
IXTA 3N120HV		3.00	4.5	1050	39	700	0.62	200	X011c	
IXTH 6N120		6.00	2.4	1950	56	850	0.42	300	X014a	
IXTT 6N120		6.00	2.4	1950	56	850	0.42	300	X019	
IXTA 3N150HV	1500	3.00	7.3	1375	38.6	900	0.50	110	X011c	X011b TO-263AB 
IXTH 3N150		3.00	7.3	1375	38.6	900	0.50	250	X014a	
IXTJ 3N150		2.50	8	1375	38.6	900	1.13	250	X016c	
IXTA 4N150HV		4.00	6	1576	44.5	900	0.45	280	X011c	
IXTH 4N150		4.00	6	1576	44.5	900	0.45	280	X014a	
IXTJ 4N150		2.50	6	1576	44.5	900	1.13	110	X016c	
IXTT 4N150HV		4.00	6	1576	44.5	900	0.45	280	X019a	X011c TO-263ABHV 
IXTH 6N150		6.00	3.5	2230	67	1500	0.23	540	X014a	
IXTJ 6N150		3.00	3.85	2230	67	1500	1.00	125	X016c	
IXTT 6N150		6.00	3.5	2230	67	1500	0.23	540	X014a	
IXTT 12N150HV	12.00	2	3720	106	1200	0.14	890	X019a		

X016c

ISO247™



X014a

TO-247AD



X019a

TO-268AAHV

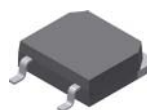







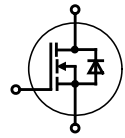

X019

TO-268AA



Linear L2™ Power MOSFETs with Extended FBSOAs





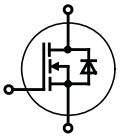

Part Type	V _{DSS}	I _{D(Cont)} Chip T _C = 25°C	R _{DS(on)} T _J = 25°C	C _{iss} typ.	Q _g typ.	t _{rr} typ.	R _{thJC}	P _D	Fig. No.	Package style
➤ New	V	A	Ω	pF	nC	ns	K/W	W		Outline drawings on pages O-36...O-59
IXTP 80N075L2	75	80	0.024	3600	103	160	0.35	357	X005a	X005a TO-220AB 
IXTA 80N075L2		80	0.024	3600	103	160	0.35	357	X011b	
IXTH 80N075L2		80	0.024	3600	103	160	0.35	357	X014a	
IXTH 140N075L2		140	0.011	9300	275	200	0.23	540	X014a	
IXTT 140N075L2HV		140	0.011	9300	275	200	0.23	540	X019a	
IXTN 240N075L2		225	0.007	19000	546	206	0.17	735	X027a	
IXTK 240N075L2		240	0.007	19000	546	206	0.13	960	X020a	
IXTX 240N075L2		240	0.007	19000	546	206	0.13	960	X015a	
IXTA 64N10L2	100	64	0.032	3620	100	180	0.35	357	X011b	X011b TO-263AB 
IXTH 64N10L2		64	0.032	3620	100	180	0.35	357	X014a	
IXTP 64N10L2		64	0.032	3620	100	180	0.35	357	X005a	
IXTH 75N10L2		75	0.021	8100	215	180	0.31	400	X014a	
IXTT 75N10L2		75	0.021	8100	215	180	0.31	400	X019	
IXTH 110N10L2		110	0.018	10500	260	230	0.21	600	X014a	
IXTT 110N10L2		110	0.018	10500	260	230	0.21	600	X019	
IXTN 200N10L2		178	0.011	23000	540	245	0.15	830	X027a	
IXTX 200N10L2	200	0.011	23000	540	245	0.12	1040	X015a		
IXTK 200N10L2	200	0.011	23000	540	245	0.12	1040	X020a	X015a PLUS247 	
IXTH 60N20L2	200	60	0.045	10500	255	330	0.23	540	X014a	X014a TO-3P 
IXTT 60N20L2		60	0.045	10500	255	330	0.23	540	X019	
IXTQ 60N20L2		60	0.045	10500	255	330	0.23	540	X017a	
IXTN 110N20L2		100	0.024	23000	500	420	0.17	735	X027a	
IXTX 110N20L2		110	0.024	23000	500	420	0.13	960	X015a	
IXTK 110N20L2		110	0.024	23000	500	420	0.13	960	X020a	
➤ IXTA 30N25L2	250	30	0.140	3200	130	315	0.35	355	X011b	X011b TO-268AA 
➤ IXTH 30N25L2		30	0.140	3200	130	315	0.35	355	X014a	
➤ IXTP 30N25L2		30	0.140	3200	130	315	0.35	355	X005a	
➤ IXTH 44N25L2		44	0.075	5740	256	366	0.31	400	X014a	
➤ IXTT 44N25L2HV		44	0.075	5740	256	366	0.31	400	X019a	
IXTH 58N25L2		58	0.064	9200	330	400	0.23	540	X014a	
IXTX 90N25L2		90	0.033	23000	640	266	0.13	960	X015a	
IXTN 90N25L2		90	0.033	23000	640	266	0.17	735	X027a	
IXTK 90N25L2		90	0.033	23000	640	266	0.13	960	X020a	
IXTH 38N30L2	300	38	0.100	7200	260	420	0.31	400	X014a	X014a TO-268AAHV 
IXTT 38N30L2		38	0.100	7200	260	420	0.31	400	X019	
IXTH 50N30L2		50	0.072	9300	330	430	0.23	540	X014a	
IXTK 80N30L2		80	0.038	19100	660	485	0.13	960	X020a	
IXTN 80N30L2		80	0.038	19100	660	485	0.17	735	X027a	
IXTX 80N30L2		80	0.038	19100	660	485	0.13	960	X015a	
IXTA 15N50L2	500	15	0.480	4080	123	570	0.42	300	X011b	X011b TO-264 
IXTP 15N50L2		15	0.480	4080	123	570	0.42	300	X005a	
IXTH 15N50L2		15	0.480	4080	123	570	0.42	300	X014a	
IXTH 30N50L2		30	0.200	8100	240	500	0.31	400	X014a	
IXTT 30N50L2		30	0.200	8100	240	500	0.31	400	X019	
IXTQ 30N50L2		30	0.200	8100	240	500	0.31	400	X017a	
IXTH 40N50L2		40	0.170	10400	320	500	0.23	540	X014a	
IXTT 40N50L2		40	0.170	10400	320	500	0.23	540	X019	
IXTQ 40N50L2		40	0.170	10400	320	500	0.23	540	X017a	
IXTN 60N50L2		53	0.100	24000	610	980	0.17	735	X027a	
IXTX 60N50L2	60	0.100	24000	610	980	0.13	960	X015a		
IXTK 60N50L2	60	0.100	24000	610	980	0.13	960	X020a	X027a SOT-227B miniBLOC 	
IXTH 30N60L2	600	30	0.240	10700	335	710	0.23	540	X014a	X014a
IXTT 30N60L2		30	0.240	10700	335	710	0.23	540	X019	
IXTQ 30N60L2		30	0.240	10700	335	710	0.23	540	X017a	

Depletion-Mode MOSFETs

„Normally On“ devices



Part Type	V _{DSS} V	I _{D(cont)} Chip T _C = 25°C A	R _{DS(on)} T _J = 25°C Ω	V _{GS(off)} max. V	C _{iss} typ. pF	C _{rss} typ. pF	Q _g typ. nC	P _D W	Fig. No.	Package style Outline drawings on pages O-36...O-59	
IXTH 16N10D2	100	16.00	0.064	-4	5700	940	225	695	X014a	X004	TO-252AA 
IXTT 16N10D2		16.00	0.064	-4	5700	940	225	695	X019		
IXTH 16N20D2	200	16.00	0.073	-4	5500	607	208	695	X014a		
IXTT 16N20D2		16.00	0.073	-4	5500	607	208	695	X019		
IXTP 08N50D2	500	0.80	4.6	-4	312	11	12.7	60	X005a	X005a	TO-220AB 
IXTY 08N50D2		0.80	4.6	-4	312	11	12.7	60	X004		
IXTA 08N50D2		0.80	4.6	-4	312	11	12.7	60	X011b		
IXTP 1R6N50D2		1.60	2.3	-4	645	16.5	23.7	100	X005a		
IXTY 1R6N50D2		1.60	2.3	-4	645	16.5	23.7	100	X004		
IXTA 1R6N50D2		1.60	2.3	-4	645	16.5	23.7	100	X011b		
IXTP 3N50D2		3.00	1.5	-4	1070	24	40	125	X005a		
IXTA 3N50D2		3.00	1.5	-4	1070	24	40	125	X011b		
IXTP 6N50D2		6.00	0.5	-4	2800	64	96	300	X005a		
IXTH 6N50D2		6.00	0.5	-4	2800	64	96	300	X014a		
IXTA 6N50D2		6.00	0.5	-4	2800	64	96	300	X011b		
IXTH 16N50D2		16.00	0.24	-4	5250	130	199	695	X014a		
IXTT 16N50D2	16.00	0.24	-4	5250	130	199	695	X019			
IXTP 08N100D2	1000	0.80	21	-4	325	6.5	14.6	60	X005a	X011b	TO-263AB 
IXTY 08N100D2		0.80	21	-4	325	6.5	14.6	60	X004		
IXTA 08N100D2		0.80	21	-4	325	6.5	14.6	60	X011b		
IXTA 08N100D2HV		0.80	21	-4	325	6.5	14.6	60	X011c		
IXTP 1R6N100D2		1.60	10	-4.5	645	11	27	100	X005a		
IXTY 1R6N100D2		1.60	10	-4.5	645	11	27	100	X004		
IXTA 1R6N100D2		1.60	10	-4.5	645	11	27	100	X011b		
IXTP 3N100D2		3.00	5.5	-4.5	1020	17	37.5	125	X005a		
IXTA 3N100D2		3.00	5.5	-4.5	1020	17	37.5	125	X011b		
IXTA 3N100D2HV		3.00	6	-4.5	1020	17	37.5	125	X011c		
IXTP 6N100D2		6.00	2.2	-4.5	2650	41	95	300	X005a	X011c	TO-263ABHV 
IXTH 6N100D2		6.00	2.2	-4.5	2650	41	95	300	X014a		
IXTA 6N100D2		6	2.2	-4.5	2650	41	95	300	X011b		
IXTT 10N100D2		10	1.5	-4.5	5320	70	200	695	X019		
IXTH 10N100D2	10	1.5	-4.5	5320	70	200	695	X014a			
IXTT 2N170D2	1700	2	6.5	-4	3650	80	110	568	X019		
IXTH 2N170D2		2	6.5	-4	3650	80	110	568	X014a		

X019

TO-268AA











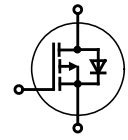

X014a

TO-247AD











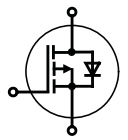

P-Channel PolarP™ Power MOSFETs



Part Type	V _{DSS} V	I _{D(cont)} Chip T _C = 25°C A	R _{DS(on)} T _J = 25°C Ω	C _{iss} typ. pF	Q _g typ. nC	t _{rr} typ. ns	R _{thJC} K/W	P _D W	Fig. No.	Package style Outline drawings on pages O-36...O-59
IXTX 32P60P	-600	-32	0.350	11100	196	480	0.14	890	X015a	X005a TO-220AB 
IXTN 32P60P		-32	0.350	11100	196	480	0.14	890	X027a	
IXTK 32P60P		-32	0.350	11100	196	480	0.14	890	X020a	
IXTR 32P60P		-18	0.385	11100	196	480	0.40	310	X016a	
IXTH 16P60P		-16	0.720	5120	92	440	0.27	460	X014a	X011b TO-263AB 
IXTT 16P60P		-16	0.720	5120	92	440	0.27	460	X019	
IXTR 16P60P		-10	0.790	5120	92	440	0.66	190	X016a	
IXTX 40P50P	-500	-40	0.230	11.5	205	477	0.14	890	X015a	X014a TO-247AD 
IXTN 40P50P		-40	0.230	11500	205	477	0.14	890	X027a	
IXTK 40P50P		-40	0.230	11500	205	477	0.14	890	X020a	
IXTR 40P50P		-22	0.260	11500	205	477	0.40	312	X016a	
IXTH 20P50P		-20	0.450	5120	103	406	0.27	460	X014a	X015a PLUS247 
IXTT 20P50P		-20	0.450	5120	103	406	0.27	460	X019	
IXTR 20P50P		-13	0.490	5120	103	406	0.66	190	X016a	
IXTP 10P50P		-10	1.000	2670	50	414	0.50	300	X005a	X016a ISOPLUS247™ 
IXTH 10P50P		-10	1.000	2670	50	414	0.50	300	X014a	
IXTA 10P50P		-10	1.000	2670	50	414	0.50	300	X011b	
IXTQ 10P50P		-10	1.000	2670	50	414	0.50	300	X017a	
IXTX 90P20P	-200	-90	0.044	12000	205	315	0.14	890	X015a	X017a TO-3P 
IXTN 90P20P		-90	0.044	12000	205	315	0.14	890	X027a	
IXTK 90P20P		-90	0.044	12000	205	315	0.14	890	X020a	
IXTR 90P20P		-53	0.048	12000	205	315	0.40	312	X016a	
IXTH 48P20P		-48	0.085	5400	103	260	0.27	462	X014a	X019 TO-268AA 
IXTT 48P20P		-48	0.085	5400	103	260	0.27	462	X019	
IXTR 48P20P		-30	0.093	5400	103	260	0.66	190	X016a	
IXTP 26P20P		-26	0.170	2740	56	240	0.42	300	X005a	X020a TO-264 
IXTH 26P20P		-26	0.170	2740	56	240	0.42	300	X014a	
IXTA 26P20P		-26	0.170	2740	56	240	0.42	300	X011b	
IXTQ 26P20P		-26	0.170	2740	56	240	0.42	300	X017a	
IXTP 36P15P	-150	-36	0.110	3100	55	228	0.42	300	X005a	X027a SOT-227B miniBLOC 
IXTH 36P15P		-36	0.110	3100	55	228	0.42	300	X014a	
IXTA 36P15P		-36	0.110	3100	55	228	0.42	300	X011b	
IXTQ 36P15P		-36	0.110	3100	55	228	0.42	300	X017a	
IXTR 36P15P		-22	0.120	2950	55	150	1.00	150	X016a	
IXTX 170P10P	-100	-170	0.012	12600	240	176	0.14	890	X015a	
IXTN 170P10P		-170	0.012	12600	240	176	0.14	890	X027a	
IXTK 170P10P		-170	0.012	12600	240	176	0.14	890	X020a	
IXTR 170P10P		-108	0.013	12600	240	176	0.40	312	X016a	
IXTH 90P10P		-90	0.025	5800	120	144	0.27	462	X014a	
IXTT 90P10P		-90	0.025	5800	120	144	0.27	462	X019	
IXTR 90P10P		-57	0.027	5800	120	144	0.66	190	X016a	
IXTP 52P10P		-52	0.050	2845	60	120	0.42	300	X005a	
IXTH 52P10P		-52	0.050	2845	60	120	0.42	300	X014a	
IXTA 52P10P		-52	0.050	2845	60	120	0.42	300	X011b	
IXTQ 52P10P		-52	0.050	2845	60	120	0.42	300	X017a	

P-Channel TrenchP™ Power MOSFETs



Part Type	V _{DSS} V	I _{D(cont)} Chip T _C = 25°C A	R _{DS(on)} T _J = 25°C Ω	C _{iss} typ. pF	Q _g typ. nC	t _{rr} typ. (max) ns	R _{thJC} K/W	P _D W	Fig. No.	Package style Outline drawings on pages O-36...O-59		
IXTK 120P20T	-200	-120	0.030	73000	740	-300	0.12	1040	X020a	X004	TO-252AA 	
IXTX 120P20T		-120	0.030	73000	740	-301	0.12	1040	X015a			
IXTN 120P20T		-106	0.030	73000	740	-302	0.15	830	X027a			
IXTR 120P20T		-90	0.032	73000	740	-303	0.21	595	X016a			
IXTH 68P20T		-68	0.055	33400	380	245	0.22	568	X014a	X005a	TO-220AB 	
IXTT 68P20T		-68	0.055	33400	380	245	0.22	568	X019			
IXTR 68P20T		-44	0.064	33400	380	245	0.46	270	X016a			
IXTA 32P20T		-32	0.130	14500	185	190	0.42	300	X011b			
IXTP 32P20T		-32	0.130	14500	185	190	0.42	300	X005a	X011b	TO-263AB 	
IXTH 32P20T		-32	0.130	14500	185	190	0.42	300	X014a			
IXTQ 32P20T		-32	0.130	14500	185	190	0.42	300	X017a			
IXTP 44P15T		-150	-44	0.065	13400	175	140	0.42	298			X005a
IXTH 44P15T		-44	0.065	13400	175	140	0.42	298	X014a	X014a	TO-247AD 	
IXTA 44P15T		-44	0.065	13400	175	140	0.42	298	X011b			
IXTQ 44P15T		-44	0.065	13400	175	140	0.42	298	X017a			
IXTP 15P15T		-15	0.240	3650	48	116	0.83	150	X005a			
IXTY 15P15T		-15	0.240	3650	48	116	0.83	150	X004	X014a	PLUS247 	
IXTA 15P15T		-15	0.240	3650	48	116	0.83	150	X011b			
IXTP 10P15T		-10	0.350	2210	36	120	1.50	83	X005a			
IXTY 10P15T		-10	0.350	2210	36	120	1.50	83	X004			
IXTA 10P15T		-10	0.350	2210	36	120	1.50	83	X011b	X015a	ISOPLUS247™ 	
IXTK 210P10T		-100	-210	0.008	69500	740	-200	0.12	1040			X020a
IXTN 210P10T		-210	0.008	69500	740	-201	0.15	830	X027a			
IXTX 210P10T		-210	0.008	69500	740	-202	0.12	1040	X015a			
IXTR 210P10T		-195	0.008	69500	740	-203	0.32	390	X016a	X016a	TO-3P 	
IXTH 140P10T		-140	0.012	31400	400	130	0.22	568	X014a			
IXTT 140P10T		-140	0.012	31400	400	130	0.22	568	X019			
IXTR 140P10T		-90	0.013	31400	400	130	0.46	270	X016a			
IXTP 76P10T		-76	0.025	13700	197	70	0.42	298	X005a	X017a	TO-268AA 	
IXTH 76P10T		-76	0.025	13700	197	70	0.42	298	X014a			
IXTA 76P10T		-76	0.025	13700	197	70	0.42	298	X011b			
IXTP 26P10T		-26	0.090	3820	52	70	0.83	150	X005a			
IXTY 26P10T		-26	0.090	3820	52	70	0.83	150	X004	X020a	TO-264 	
IXTA 26P10T		-26	0.090	3820	52	70	0.83	150	X011b			
IXTP 18P10T		-18	0.120	2100	39	62	1.50	83	X005a			
IXTY 18P10T		-18	0.120	2100	39	62	1.50	83	X004			
IXTA 18P10T		-18	0.120	2100	39	62	1.50	83	X011b	X019	SOT-227B miniBLOC 	
IXTP 96P085T		-85	-96	0.013	13100	180	55	0.42	298			X005a
IXTH 96P085T		-96	0.013	13100	180	55	0.42	298	X014a			
IXTA 96P085T		-96	0.013	13100	180	55	0.42	298	X011b			
IXTP 24P085T		-24	0.065	2090	41	40	1.50	83	X005a	X027a		
IXTA 24P085T		-24	0.065	2090	41	40	1.50	83	X011b			
IXTP 120P065T		-65	-120	0.010	13200	185	53	0.42	298			X005a
IXTH 120P065T		-120	0.010	13200	185	53	0.42	298	X014a			
IXTA 120P065T		-120	0.010	13200	185	53	0.42	298	X011b	X027a		
IXTP 28P065T		-28	0.045	2030	46	31	1.50	83	X005a			
IXTA 28P065T		-28	0.045	2030	46	31	1.50	83	X011b			
IXTP 140P05T		-50	-140	0.009	13500	200	53	0.42	298			X005a
IXTH 140P05T		-140	0.009	13500	200	53	0.42	298	X014a	X027a		
IXTA 140P05T		-140	0.009	13500	200	53	0.42	298	X011b			
IXTP 48P05T		-48	0.030	3660	53	30	0.83	150	X005a			
IXTY 48P05T		-48	0.030	3660	53	30	0.83	150	X004			
IXTA 48P05T		-48	0.030	3660	53	30	0.83	150	X011b	X004		
IXTP 32P05T		-32	0.039	1975	46	26	1.50	83	X005a			
IXTY 32P05T		-32	0.039	1975	46	26	1.50	83	X004			
IXTA 32P05T		-32	0.039	1975	46	26	1.50	83	X011b			

Superjunction Power MOSFET

Powered by Infineon CoolMOST™ superjunction bare die

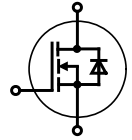

K Series



Part Type	V _{DSS}	I _{D25} T _C = 25°C	R _{DS(on)} max. T _J = 25°C	Q _g typ.	R _{thJC}	V _{ISOL} RMS	Fig. No.	Package style Outline drawings on pages O-36...O-59
○ Not for new design	V	A	Ω	c	K/W	V		
C3 Series								
○ IXKC 20N60C	600	14	0.190	80	1.00	2500	X010a	X005a TO-220AB
IXKR 40N60C		38	0.070	250	0.45	2500	X016a	
○ IXKN 40N60C		40	0.070	250	0.43	2500	X027a	X010a ISOPLUS220™
○ IXKN 75N60C		75	0.036	500	0.22	2500	X027a	
IXKR 25N80C	800	25	0.150	170	0.50	2500	X016a	
C5 Series								
○ IXKH 35N60C5	600	35	0.100	60	0.35	-	X014a	X014a TO-247AD
○ IXKR 47N60C5		47	0.045	150	0.45	2500	X016a	
○ IXKH 70N60C5		70	0.045	150	0.20	-	X014a	X016a ISOPLUS247™
IXKT 70N60C5		66	0.045	150	0.23	-	X019	
IXKF FMD LKK ...P... ...RK... ...RP...								
Part Type	V _{DSS}	I _{D25} T _C = 25°C	R _{DS(on)} max. T _J = 25°C	Q _g typ.	R _{thJC}	Config.	Fig. No.	
◇ Under Development								
○ Not for new design	V	A	Ω	nC	K/W			
➤ New								
Configurations in i4-PAC™								
IXKF 40N60SCD1	600	38	0.070	250	0.45	single	X024c	X019 TO-268AA
FMD 15-06KC5		15	0.165	40	1.10	boost	X024a	
○ FMD 40-06KC		38	0.070	250	0.45			
Configuration in ISOPLUS264™ Package								
○ LKK 47-06C5	600	2 x 47	0.045	150	0.45	dual	X022c	X020a TO-264
Configurations in SMPD Package								
MKE 38RK600DFELB	600	50	0.045	150	0.40	buck/boost	X030a	X022c ISOPLUS264
MKE 38P600LB	600	50	0.040	150	0.40	phase leg		
◇ MKH 17RP650DCGLB	650	22	0.110	118	0.90	dual boost		
X2 Class MOSFETs in SMPD Package								
➤ MXB 40RK600DFELB	600	53	0.052	108	0.32	buck/boost	X030a	X024a ISOPLUS i4-PAC™
➤ MXB 40P650LB	650	53	0.052	108	0.32	phase leg		
X030a SMPD-B X027a SOT-227B miniBLOC X024c ISOPLUS i4-PAC™ X024a ISOPLUS i4-PAC™								

Littelfuse SiC MOSFETs offer a rewarding alternative to traditional Si based power transistor devices. The MOSFET device structure enables lower per-cycle switching losses and improved light load efficiency when compared to similarly rated IGBTs. Inherent material properties allow the SiC MOSFET to outclass its Si MOSFET counterparts in terms of blocking voltage, specific on resistance, and junction capacitances.

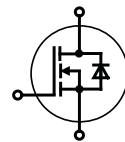
Littelfuse SiC Schottky Diodes have negligible reverse recovery current, high surge capability, and a maximum operating junction temperature of 175°C. These diodes are ideal for applications where improvements in efficiency, reliability, and thermal management are desired.



SiC MOSFETs

Part Type	V _{DSS}	I _D T _C = 25°C	I _D T _C = 100°C	R _{DS(on)} typ. T _J = 25°C	C _{iss} typ	Q _g typ	R _{thJC}	Fig. No.	Package style Outline drawings on pages O-60...O-64
◇ Under Development	V	A	A	mΩ	pF	nC	K/W		
◇ LSIC1MO120E0025	1200	90	60	25	4465	250	0.30	L014a	L012b TO-263 (7) 
◇ LSIC1MO120E0040		65	50	40	2825	160	0.42		
LSIC1MO120E0080		39	25	80	1825	95	0.70		
LSIC1MO120E0120		27	18	120	1125	80	0.90		
LSIC1MO120E0160		22	14	160	870	57	1.00		
◇ LSIC1MO120G0025		90	60	25	4465	250	0.30	L014d	
◇ LSIC1MO120G0040		65	50	40	2825	160	0.42		
◇ LSIC1MO120G0080		39	25	80	1825	95	0.70		
◇ LSIC1MO120G0120		27	18	120	1125	80	0.90		
◇ LSIC1MO120G0160		22	14	160	870	57	1.00		
◇ LSIC1MO120T0080	1700	39	25	80	1825	95	0.70	L012b	L014d TO-247-4L 
◇ LSIC1MO120T0120		27	18	120	1125	80	0.90		
◇ LSIC1MO120T0160		22	14	160	870	57	1.00		
◇ LSCI1MO120N0025		90	60	25	4465	250	0.42	L027a	
LSIC1MO170E1000	1700	5	3.5	750	200	15	2.30	L014a	
➤ LSIC1MO170T0750		5	3.5	750	200	15	2.30	L012b	
◇ LSIC1MO170H0750		5	3.5	750	200	15	2.30	L019a	

L027a **SOT-227B miniBLOC**



L019a **TO-268AA (HV)**

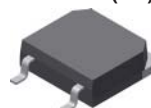



L014a **TO-247 AD**

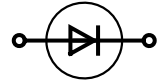





SiC Diodes

Type	V _{RRM}	I _F	@ T _C	I _F	V _F	Q _c	R _{thJC}	Fig. No.	Package style
Under Development		DC		DC @ 25°C					Outline drawings
➤ New	V	A	°C	A	V	nC	K/W		on pages O-38, O-60 ... O-64
➤ LSIC2SD065A06A	650	6	152	18.5	1.5	20	2.00	L005b	L004a
➤ LSIC2SD065A08A		8	150	23.0	1.5	29	1.70		
➤ LSIC2SD065A10A		10	147	27.0	1.5	30	1.50		
➤ LSIC2SD065A16A		16	140	38.0	1.5	48	1.20		
➤ LSIC2SD065A20A		20	135	45.0	1.5	63	1.10		
➤ LSIC2SD065C06A		6	152	18.5	1.5	20	2.00	L004a	
➤ LSIC2SD065C08A		8	150	23.0	1.5	29	1.70		
➤ LSIC2SD065C10A		10	147	27.0	1.5	30	1.50		
➤ LSIC2SD065C16A		16	140	38.0	1.5	48	1.20		
➤ LSIC2SD065C20A		20	135	45.0	1.5	63	1.10		
➤ LSIC2SD065D06A		6	152	18.5	1.5	20	2.00	X011c	L005b
➤ LSIC2SD065D08A		8	150	23.0	1.5	29	1.70		
➤ LSIC2SD065D10A		10	147	27.0	1.5	30	1.50		
➤ LSIC2SD065D16A		16	140	38.0	1.5	48	1.20		
➤ LSIC2SD065D20A		20	135	45.0	1.5	63	1.10		
➤ LSIC2SD065E12CCA		6/12*	152	18.5/37*	1.5	20	2.0/1.00*	L014a	
➤ LSIC2SD065E16CCA		8/16*	150	23/46*	1.5	29	1.7/0.85*		
➤ LSIC2SD065E20CCA		10/20*	147	27/54*	1.5	30	1.5/0.75*		
➤ LSIC2SD065E32CCA		16/32*	140	38/76*	1.5	48	1.2/0.60*		
➤ LSIC2SD065E40CCA		20/40*	135	45/90*	1.5	63	1.1/0.55*		
◇ LSIC2SB065B10A		10	147	27.0	1.5	30	TBD	L014b	X011c
◇ LSIC2SD065B16A		16	140	38.0	1.5	48	TBD		
◇ LSIC2SB065B20A		20	135	45.0	1.5	63	TBD		
◇ LSIC2SB065B32A		32	150	70.0	1.5	TBD	TBD		
◇ LSIC2SB065B40A		40	150	85.0	1.5	TBD	TBD		
◇ LSIC2SD065N40PA		20/40*	135	45/90*	1.5	63	TBD	L027a	
◇ LSIC2SD065N80PA		40/80*	150	80/160*	1.5	TBD	TBD		
◇ LSIC2SD065N128PA		64/128*	150	110/220*	1.5	TBD	TBD		
LSIC2SD120A05	1200	5	158	17.5	1.5	30	1.50	L005b	L014a
LSIC2SD120A08		8	154	24.5	1.5	47	1.20		
LSIC2SD120A10		10	151	28.0	1.5	57	1.10		
LSIC2SD120A15		15	150	44.0	1.5	92	0.70		
LSIC2SD120A20		20	150	54.5	1.5	115	0.60		
LSIC2SD120C05		5	159	18.1	1.5	30	1.50	L004a	
LSIC2SD120C08		8	154	24.5	1.5	47	1.20		
LSIC2SD120C10		10	156	33.0	1.5	57	0.85		
LSIC2SD120D10		10	151	28.0	1.5	57	1.10	X011c	L014b
LSIC2SD120D15		15	150	44.0	1.5	92	0.70		
LSIC2SD120D20		20	150	54.5	1.5	115	0.60		
◇ LSIC2SB120B10A		10	151	28.0	1.5	57	TBD	L014b	
◇ LSIC2SB120B20A		20	135	45.0	1.5	115	TBD		
◇ LSIC2SB120B30A		30	150	54.0	1.5	129	TBD		
◇ LSIC2SB120B40A		40	150	65.0	1.5	145	TBD		
➤ LSIC2SD120N40PA		20/40*	150	45/90*	1.5	230	0.80/1.60*	L027a	L027a
➤ LSIC2SD120N80PA		40/80*	150	80/160*	1.5	290	0.60/1.20*		
➤ LSIC2SD120N120PA		60/120*	121	110/220*	1.5	360	0.40/0.80*		
LSIC2SD120E10CC		5/10*	158	17.5/35.0*	1.5	30	0.75/1.50*	L014a	
LSIC2SD120E15CC		8/16*	154	24.5/49.0*	1.5	47	0.60/1.20*		
LSIC2SD120E20CC		10/20*	151	28.0/56.0*	1.5	57	0.55/1.10*		
LSIC2SD120E30CC		15/30*	152	43.8/87.6*	1.5	92	0.35/0.70*		
LSIC2SD120E40CC		20/40*	150	54.5/109*	1.5	115	0.30/0.60*		
◇ LSIC2SB170B10A	1700	10	150	30.0	1.5	57	TBD	L014b	
◇ LSIC2SB170B25A		25	150	61.0	1.5	122	TBD		
◇ LSIC2SB170B50A		50	150	143.0	1.5	392	0.20		

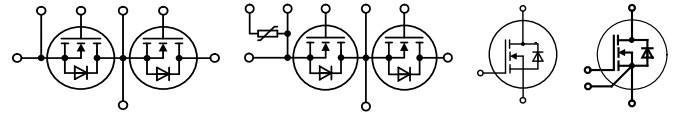
* per Leg/Component

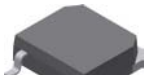

Part Type	V _{DSS}	I _{D25} T _C = 25°C	I _{D80} T _C = 80°C	R _{DS(on)} T _C = 25°C	C _{iss} typ	Q _g typ	R _{thJC}	Fig. No.	Package style Outline drawings on pages O-36...O-59
under development	V	A	A	mΩ (typ)	pF	nC	K/W		
New									
IXFN 130N90SK ¹⁾	900	136	109	10	4500	68	0.42	X027a	X016c ISO247™ 
IXFN 27N120SK ¹⁾	1200	27	21.5	80	950	62	1.10	X027a	
IXFN 50N120SiC		47	35	40	1900	100	0.55		
IXFN 50N120SK ¹⁾		48	38	40	1895	115	0.60		
IXFN 70N120SK ¹⁾		68	55	25	2790	160	0.45		
MCB 60I1200TZ		90	70	25	2790	160	0.27		
IXFN 90N170SK ¹⁾	1700	90	67	23	7340	376	0.22	X027a	
Phase Leg									
MCB 20P1200LB	1200	22	17.5	80	950	62	1.60	X030a	X019a TO-268AAHV 
MCB 30P1200LB		37	29.5	40	1895	115	1.00		
MCB 40P1200LB		58	43	25	2790	160	0.60		
MCB 60P1200TLB *		77	62	25	2790	161	0.35		
MCB 35P1700TLB *	1700	47	35	45	3670	188	0.40		

¹⁾ Kelvin source gate connection; * NTC included

Boost Circuits

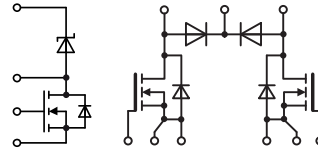

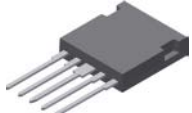

Type	Circuit and Technology	V _{DSS} max	I _{D80} T _C = 80°C	R _{DS(on)} typ	I _{F80} Boost Diode	Fig. No.	Package style
under development		V	A	Ω	A		
New							
MXB 12R650DCGFC	X2 Class Boost + SiC Diode	650	12	0.15 (max)	11,5	X024a	X024a ISOPLUS i4-PAC™ 
MKH 17RP650DCGLB	Dual Boost Superjunction ¹⁾ + SiC		2 x 16	0.11 (max)	2 x 16	X030a	

¹⁾ Powered by Infineon CoolMOS™ superjunction bare die C6

Silicon Carbide Schottky Diodes

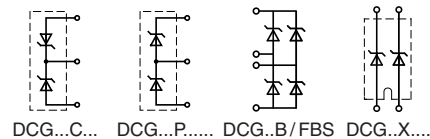
No reverse recovery



Type	V _{RRM}	I _{F80} per diode	I _{FAV} d = 0.5	@ T _C	V _F typ., T _{VJ} = 175°C	@ I _F	R _{thJC}	Fig. No.	Package style
Under development	V	A	A	°C	V	A	K/W		
New									
Dual									
DCG 160X650NA	650	105	2x 80	80	1.35	50	0.47	X027a	X027a SOT-227B miniBLOC 
DCG 40X1200LB	1200	19.5	2x 14.5	80	2.20	20	1.90	X030a	
DCG 45X1200NA		30	2x 22	80	2.20	20	1.10	X027a	
DCG 85X1200NA		59	2x 43	80	2.20	40	0.57		
DCG 100X1200NA		66	2x 49	80	2.25	50	0.51		
DCG 130X1200NA		88	2x 64	80	2.30	60	0.39		
Common Cathode									
DCG 20C1200HR	1200	13	2x 10	80	2.20	10	3.00	X016c	X030a SMPD-B 
DCG 35C1200HR		23	2x 17	80	2.20	20	1.80		
Phase Leg									
DCG 10P1200HR	2x 1200	13	10	80	2.20	10	3.00	X016c	
DCG 17P1200HR		23	17	80	2.20	20	1.80		
Full Bridge									
DCG 20B650LB	650	16	10.5	80	2.0	10	2.10	X030a	
FBS 10-12SC	1200	6.0	4.5	80	2.6	5	7.00	X024a	
DCG 20B1200LB		12.5	9.2	80	2.0	20	3.30	X030a	

MOSFET Modules

HiPerFET™ and Polar MOSFET Technology

- low R_{DSon}
- fast body diode
- rugged

Suffix „F“ = HiPerFET™ Technology with Fast Intrinsic Diode

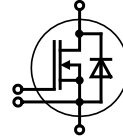

Part Type	V_{DSS}	I_{D25} $T_C = 25^\circ C$	I_{D80} $T_C = 80^\circ C$	R_{DSon} typ. $T_J = 25^\circ C$	t_r	t_f	R_{thJC}	Fig. No.	Package style Outline drawings on pages O-36...O-59
○ Not for new design	V	A	A	mΩ	ns	ns	K/W		
Single Switch Module									
○ VMO 1200-01F		1245	930	1.35	200	500	0.039	X130d	

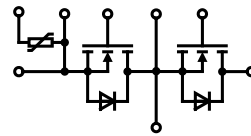

Part Type	V_{DSS}	I_{D25} $T_C = 25^\circ C$	I_{D80} $T_C = 80^\circ C$	R_{DSon} typ. $T_J = 25^\circ C$	t_r	t_f	R_{thJC}	Fig. No.	
◇ under development	V	A	A	mΩ	ns	ns	K/W		
MOSFET Modules – Phase Leg Configuration									
VMM 90-09F	900	85	65	65	180	140	0.08	X130e	
◇ MMPA 60P1000TLA	1000	108	80	58			0.06		

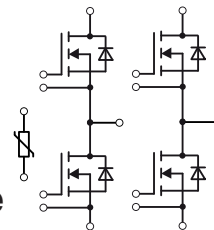

X2-Class HiPerFET™ Full Bridge MOSFET Module

Part Type	V_{DSS}	I_{D25} $T_C = 25^\circ C$	I_{D80} $T_C = 80^\circ C$	R_{DSon} max. $T_J = 25^\circ C$	t_r	t_f	R_{thJC}	Fig. No.
◇ under development	V	A	A	mΩ	ns	ns	K/W	
◇ MMXB 95HX650PTED	650	130	96	20			0.17	X112a

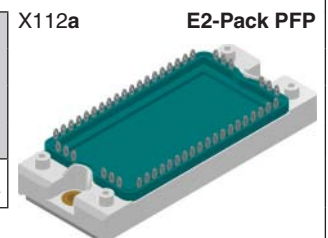

Rectifier Bridges for Power Factor Correction

Power Stage for Boost Converters (Power Factor Correction)

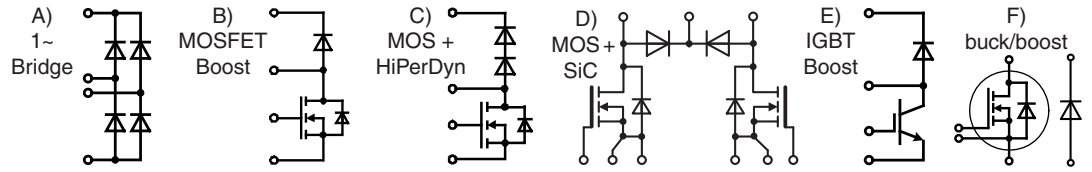

1-phase PFC

Type		Circuit and Technology	V_{DSS} max	I_b $T_c = 25^\circ\text{C}$	$R_{DS(on)}$ max	V_{RRM} Boost Diode	V_{RRM} Rectifier	Fig. No.	Package style
◇ under development			V	A	Ω	V	V		Outline drawings on pages O-36...O-59
○ Not for new design									
➤ New									
MOSFET									
		C	Superjunction CP ¹⁾	600	15	0.165	-	X024a	X024a ISOPLUS i4-PAC
		C	Superjunction C3 ¹⁾		38	0.070	-		
		B	X2 Class + SiC	650	16	0.150	650	-	
		F	Superjunction CP ¹⁾		50	0.045	600	X030a	X030a SMPD-B
		F	X2 Class	650	68	0.038	-		
		D	Superjunction C6 ¹⁾ + SiC		22	0.110	-		
		A+B	HiPerFET™	500	35	0.120	600	800	
					47	0.120		1200	
		A+B	Polar	600	50	0.120	600	1600	

Type		Circuit and Technology	V_{RRM} V	I_{DAV} A	@ T_c $^\circ\text{C}$	Fig. No.		
➤ New								
Rectifier								
		A	Standard	1200	22	90	X024a	X105b V1-B-Pack
					40	90		
		A	low V_F	800	124	135	X030a	
					130	90		
		A	low V_F	1200	124	135		

1) Powered by Infineon CoolMOS™ superjunction bare die
 2) Recommended in combination with FMD and FID
 3) Recommended in combination with MKE, MKG and MXB
 4) AEC-Q-101

3-phase PFC

“Vienna Rectifier“ circuit

- wide input voltage range
- sinusoidal mains input currents in phase with mains
- boost converter operation:
 - input: 3~ AC mains without neutral conductor
 - output: stabilized DC link with center point
- one module used per phase

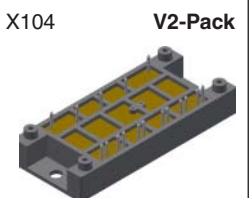
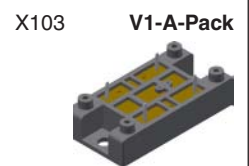
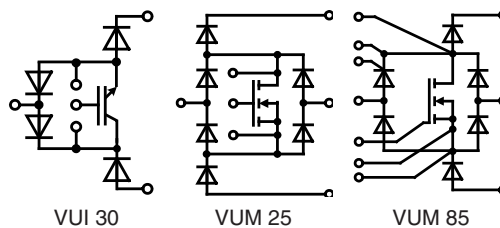

Type	PN / kW	Configuration	Fig. No.
① contact factory	3 ~ 400V. $T_c = 80^\circ\text{C}$		
VUM 25-05E ①	10	Vienna rectifier current	X103
VUM 85-05A ①	30	Vienna rectifier current	X104
VUI 30-12N1 ①	15	IGBT stage for buck @ boost PWM converter	X103

Diodes for High Switching Frequencies

Fast Recovery Epitaxial Diodes (HiPerFRED, FRED) and FRD (SONIC)

Power switches (IGBT, MOSFET, BJT, GTO) for applications in electronics are only as good as their associated free-wheeling diodes. At increasing switching frequencies, the proper functioning and efficiency of the power switch, aside from conduction losses, is determined by the turn-off behavior of the diode (characterized by Q_{rr} , I_{RM} and t_{rr} - Fig. 1). With optimized ultra-fast switching diodes, the development engineer has various possibilities: either higher pulse rate or higher current load or smaller heatsink or more conservative operation due to „cooler“ chips.

The reverse current characteristic following the peak reverse current I_{RM} is another very important property. The slope of the decaying reverse current di_{rr}/dt results from design parameters (technology and diffusion of the diode chips). In a circuit this current slope, in conjunction with parasitic inductances (e.g. connecting leads), causes over-voltage spikes and high frequency interference voltages. The higher the

di_{rr}/dt („hard recovery“ or „snap-off“ behavior) the higher is the resulting additional stress for both the diode and the paralleled switch. A slow decay of the reverse current („soft recovery“ behavior), is the most desirable characteristic, and this is designed into all diodes. The wide range of available blocking voltages makes it possible to apply these diodes as output rectifiers in switch-mode power supplies (SMPS) as well as protective and free-wheeling diodes for power switches in inverters.

Diodes for General Purpose Applications

Rectifier Diodes

Diodes of the DS-series (anode on stud) and of the DSI-series (cathode on stud) are mainly used for rectifying 50 or 60 Hz mains currents. Discrete diodes in plastic and metal housings and also different diode bridges are available for standard line voltages (from 110 V to 690 V AC).

Avalanche Diodes

Avalanche diodes or surge-voltage-proof rectifier diodes of the series DSA (anode on stud) and DSAI (cathode on stud) differ from standard diodes of the series DS and DSI in the following

manner: the operation in avalanche breakdown above the normal reverse blocking voltage (V_{RRM}) can be tolerated as long as the power is within the specified maximum permissible non-repetitive reverse surge dissipation P_{RSM} at the specified pulse width. In order to have technologically good control of the avalanche breakdown, it is important to ensure homogeneous doping of the middle zone of the silicon chip and suitable junction termination and passivation at the edges where PN-junctions are exposed to the surface (high field strength at the edge). Because of this ruggedness against periodically occurring short-term voltage surges in the blocking direction, the user frequently can do without protective overvoltage net-works. In addition, if avalanche diodes are put in series for high voltage applications, the sharp avalanche breakdown of the blocking characteristic ensures static and dynamic voltage distribution uniformly across each device. Thus, in general, none of the series diodes will be overstressed by reverse voltages which are substantially above the avalanche voltage. All high voltage rectifier modules manufactured in quantity are assembled with avalanche diodes.

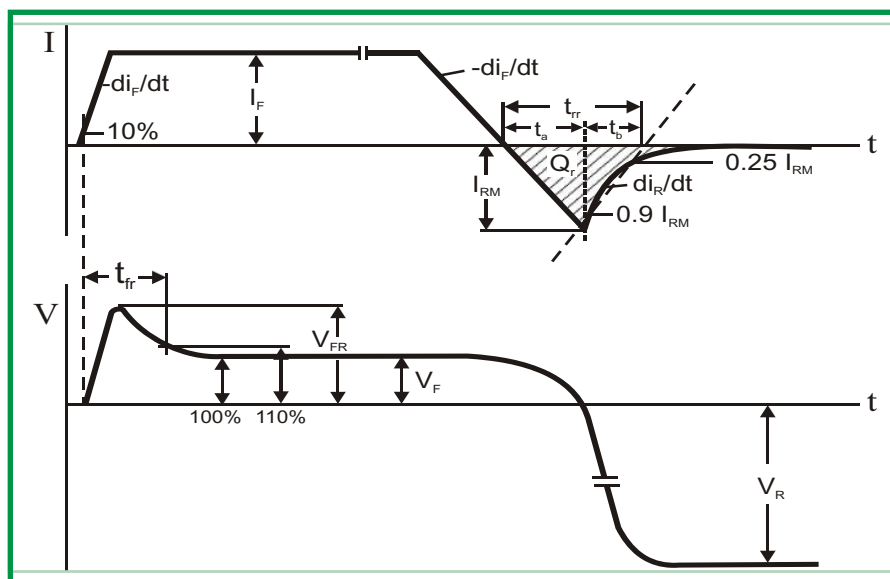
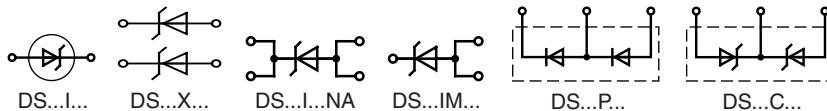

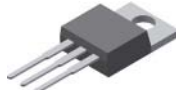









Fig. 1: Current and voltage during turn-on and turn-off switching of fast diodes

Schottky Gen² Diodes

$I_{FAV} = 10 - 300 \text{ A}$







Type	V_{RRM}	I_{FAV}	@ T_C	V_F	@ I_F	T_{VJM}	R_{thJC}	Fig. No.	Package style Outline drawings on pages O-36...O-59
➤ New	V	A	°C	V	A	°C	K/W		
DSB 20I15PA DSB 40C15PB	15	20 2x 20	130 130	0.39 0.39	20 20	150 150	1.75 1.75	X005b X005a	X004 TO-252AA 
DSB 15I30UC DSB 30C30PB DSB 60C30PB DSB 60C30HB	30	15 2x 15 2x 30 2x 30	125 130 130 125	0.44 0.44 0.49 0.47	15 15 30 30	150 150 150 150	2.00 1.75 0.85 0.95	X004 X005a X005a X014a	X005a TO-220AB 
DSB 10I45PM DSA 20C45PB DSA 15I45PA DSA 15IM45UC DSA 15IM45IB DSB 15IM45IB DSA 30C45PB DSA 30C45PC DSB 30C45PB DSA 30C45HB DSB 30C45HB DSA 60C45PB DSB 60C45PB DSA 60C45HB DSB 60C45HB DSA 80C45HB DSB 80C45HB DSA 300I45NA	45	10 2x 10 15 15 15 2x 15 2x 15 2x 15 2x 15 2x 15 2x 15 2x 30 2x 30 2x 30 2x 30 2x 40 2x 40 300	115 155 155 150 155 125 155 155 125 155 125 150 125 150 125 150 120 95	0.52 0.62 0.63 0.63 0.63 0.63 0.63 0.55 0.63 0.63 0.54 0.67 0.60 0.66 0.58 0.69 0.59 0.70	10 10 15 15 15 15 15 15 15 15 15 30 30 30 30 40 40 300	150 175 175 175 175 175 175 150 175 175 150 175 150 175 150 175 150 150	4.50 2.40 1.75 2.00 1.75 1.75 1.75 1.75 1.75 1.75 0.85 0.85 0.95 0.95 0.70 0.70 0.20	X007b X005a X005b X008a X008a X005a X011b X005a X007a X014a X014a X005a X005a X014a X014a X014a X014a X027a	X005b TO-220AC  X007a TO-220ABFP  X007b TO-220ACFP  X008a TO-262AA (I²-PAK) 
DSA 20C60PB DSA 20C60PN DSB 20C60PN DSA 30C60PB DSB 30C60PB DSA 60C60PB DSB 60C60PB DSA 60C60HB DSB 60C60HB	60	2x 10 2x 10 2x 10 2x 15 2x 15 2x 30 2x 30 2x 30 2x 30 2x 30	155 140 110 150 125 150 125 150 150 125	0.70 0.70 0.62 0.72 0.64 0.77 0.69 0.75 0.75 0.67	10 10 10 15 15 30 30 30 30 30	175 175 150 175 150 175 150 175 175 150	2.40 4.50 4.50 1.75 1.75 0.85 0.85 0.95 0.95 0.95	X005a X007a X007a X005a X005a X005a X005a X014a X014a X014a	X011b TO-263AB  X014a TO-247AD 
DSA 10I100PM DSA 10IM100UC DSA 20C100PB DSA 20C100PN DSA 30C100PB DSA 30C100PN DSA 30C100HB DSA 30C100QB DSA 50C100HB DSA 50C100QB DSA 30I100PA DSA 60C100PB DSA 70C100HB DSA 80C100PB DSA 300I100NA	100	10 10 2x 10 2x 10 2x 15 2x 15 2x 15 2x 15 2x 25 2x 25 30 2x 30 2x 35 2x 40 300	135 150 155 135 150 120 150 150 155 155 150 150 150 150 90	0.71 0.71 0.71 0.71 0.73 0.73 0.72 0.72 0.72 0.72 0.78 0.78 0.74 0.80 0.79	10 10 10 10 15 15 15 15 25 25 30 30 35 40 300	175 175 175 175 175 175 175 175 175 175 175 175 175 175 150	4.50 3.00 2.40 4.50 1.75 4.25 1.75 1.75 0.95 0.95 0.85 0.85 0.70 0.60 0.20	X007b X004 X005a X007a X005a X007a X014a X017a X014a X017a X005b X005a X014a X005a X027a	X017a TO-3P  X027a SOT-227B miniBLOC 

Data according to IEC 60747 and refer to a single diode or thyristor unless otherwise stated.

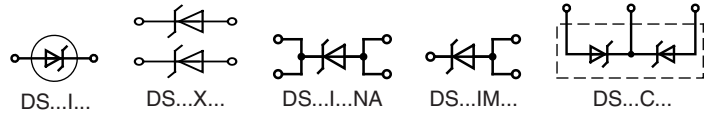
Schottky Gen² Diodes

$I_{FAV} = 5 - 300 \text{ A}$



Type	V_{RRM}	I_{FAV} d = 0.5	@ T_C °C	V_F $T_{VJ} = 125^\circ\text{C}$	@ I_F A	T_{VJM} °C	R_{thJC} K/W	Fig. No.	Package style			
	V								A	°C	V	A
DSA 10C150PB	150	2x 5	155	0.71	5	175	4.80	X005a	X004	TO-252AA 		
DSA 10C150UC		2x 5	155	0.71	5	175	4.80	X004				
DSA 20C150PB		2x 10	155	0.73	10	175	2.40	X005a				
DSA 20C150PN		2x 10	135	0.73	10	175	4.50	X007a				
DSA 15IM150UC		15	155	0.75	15	175	2.00	X004				
DSA 30C150PB		2x 15	150	0.75	15	175	1.75	X005a				
DSA 30C150PC		2x 15	150	0.75	15	175	1.75	X011b			X005a	
DSA 30C150HB		2x 15	150	0.74	15	175	1.75	X014a				
DSA 50C150HB		2x 25	155	0.74	25	175	0.95	X014a				
DSA 30I150PA		30	150	0.80	30	175	0.85	X005b			X005b	TO-220AB 
DSA 60C150PB		2x 30	150	0.80	30	175	0.85	X005a				
DSA 70C150HB		2x 35	150	0.77	35	175	0.70	X014a				
DSA 120C150QB		2x 60	150	0.80	60	175	0.40	X017a			X005b	TO-220AC 
DSA 120X150LB	2x 60	150	0.80	60	175	0.80	X030a					
DSA 240X150NA	2x 120	95	0.85	120	150	0.40	X027a	X008a	TO-262AA (I²-PAK) 			
DSA 20C200PB	200	2x 10	155	0.75	10	175	2.40			X005a		
DSA 15IM200UC		15	145	0.78	15	175	2.00			X004		
DSA 30C200IB		2x 15	150	0.78	15	175	1.75			X008a		
DSA 30C200PB		2x 15	150	0.78	15	175	1.75			X005a		
DSA 30C200PC		2x 15	150	0.78	15	175	1.75			X011b		
DSA 70C200HB		2x 35	150	0.79	35	175	0.70			X014a		
DSA 90C200HB		2x 45	145	0.86	45	175	0.55			X014a		
DSA 90C200HR		2x 45	140	0.79	45	175	0.70			X016c		
DSA 120X200LB		2x 60	150	0.87	60	175	0.80			X030a		
DSA 240X200LB		2x 120	150	0.87	120	175	0.40			X030a		
DSA 240X200NA		2x 120	90	0.87	120	150	0.40			X027a		
DSA 300I200NA		300	80	0.88	300	150	0.20			X027a		

X016c

ISO247™



X014a

TO-247AD



X011b

TO-263AB



X017a

TO-3P



X030a

SMPD-B



X027a

**SOT-227B
miniBLOC**



Schottky Diodes

$I_{FAV} = 6 - 2x 200 A$

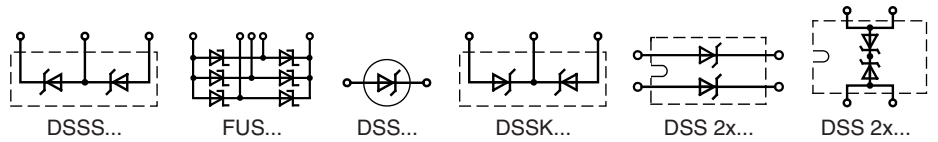

Type	V_{RRM} V	I_{FAV} A d = 0.5	@ T_C °C	V_F V $T_{VJ} = 125^\circ C$	@ I_F A	T_{VJM} °C	R_{thJC} K/W	Fig. No.	Package style Outline drawings on pages O-36...O-59
DSS 40-0008D DSSK 80-0008D ① DSS 2x200-0008D	8	40 2x 40 2x 200	130 130 90	0.28 0.28 0.28	40 40 100	150 150 150	0.80 0.80 0.40	X014a X014a X027b	X004 TO-252AA
DSS 20-0015B DSSK 40-0015B DSSK 70-0015B	15	20 2x 20 2x 35	135 135 130	0.33 0.32 0.35	20 20 35	150 150 150	1.40 1.40 1.10	X005b X014a X014a	X005a TO-220AB
DSS 6-0025BS DSS 25-0025B DSSK 18-0025BS DSSK 38-0025B DSSK 38-0025BS DSSK 48-0025B DSSK 50-0025B DSSK 80-0025B	25	6 25 2x 10 2x 20 2x 20 2x 25 2x 25 2x 40	140 125 140 130 130 130 125 130	0.30 0.45 0.37 0.40 0.40 0.35 0.43 0.39	6 25 10 20 20 20 25 40	150 150 150 150 150 150 150 150	3.00 1.40 1.70 1.40 1.40 1.20 1.40 0.80	X004 X005b X011b X005a X011b X005a X014a X014a	X005a TO-220AB X005b TO-220AC
DSSK 48-003B DSSK 48-003BS DSSK 70-003B DSSK 80-003B	30	2x 25 2x 25 2x 35 2x 40	130 130 125 130	0.35 0.35 0.39 0.39	20 20 35 40	150 150 150 150	1.20 1.20 1.10 0.80	X005a X011b X014a X014a	X010b ISOPLUS220™
DSS 6-0045AS DSS 10-0045B DSS 16-0045A DSS 16-0045AS DSS 25-0045A DSS 60-0045B DSSK 20-0045B DSSK 28-0045BS DSSK 60-0045A DSSK 60-0045B DSSK 80-0045B DSS 2x61-0045A DSS 2x81-0045B DSS 2x121-0045B ① DSS 2x160-0045A	45	6 10 16 16 25 60 2x 10 2x 15 2x 30 2x 30 2x 40 2x 60 2x 80 2x 120 2x 160	165 135 160 160 155 105 135 135 150 125 125 110 85 100 90	0.50 0.46 0.56 0.56 0.56 0.57 0.46 0.43 0.58 0.45 0.46 0.65 0.63 0.59 0.72	6 10 16 16 25 60 10 15 30 30 40 60 80 120 160	175 150 175 175 175 150 150 150 175 150 150 150 150 150 150 150	3.00 1.70 1.40 1.40 1.10 0.80 1.70 1.40 1.10 1.10 0.80 0.80 0.80 0.40 0.40 3.10	X004 X005b X005b X011b X005b X014b X005a X011b X014a X014a X014a X027a X027a X027a X027b	X011b TO-263AB X014a TO-247AD
FUS 45-0045B		45	90	0.54	15	150	3.10	X024a	X014b TO-247AD
DSS 10-006A DSSK 28-006BS DSSK 40-006B DSSK 80-006B DSSK 80-006BR	60	10 2x 15 2x 20 2x 40 2x 40	160 135 135 120 120	0.65 0.52 0.46 0.51 0.51	10 15 20 40 40	175 150 150 150 150	1.70 1.40 1.10 0.80 0.80	X005b X011b X014a X014a X016a	X016a ISOPLUS247™
DSSK 40-008B DSSS 35-008AR DSSK 70-008A DSSK 70-008AR DSS 2x111-008A	80	2x 20 2x 80 2x 35 2x 35 2x 110	130 150 150 150 105	0.52 0.68 0.64 0.64 0.72	20 35 35 35 100	150 175 175 175 150	1.10 0.80 0.80 0.80 0.40	X014a X016a X014a X016a X027a	X016a ISOPLUS247™
DSS 10-01A DSS 10-01AS DSS 16-01A DSS 16-01AS DSS 20-01AC DSSS 30-01AR	100	10 10 16 16 20 2x 100	160 160 155 155 140 155	0.66 0.66 0.65 0.65 0.80 0.63	10 10 16 16 20 30	175 175 175 175 175 175	1.70 1.70 1.40 1.40 1.70 0.80	X005b X011b X005b X011b X010b X016a	X024a ISOPLUS i4-PAC™
DSSK 16-01A DSSK 16-01AS DSSK 28-01AS DSSK 30-01A DSSK 50-01A DSS 2x41-01A DSS 2x61-01A ① DSS 2x160-01A		2x 8 2x 8 2x 15 2x 15 2x 25 2x 40 2x 60 2x 160	165 165 160 160 155 110 105 80	0.63 0.63 0.64 0.63 0.64 0.70 0.74 0.81	8 8 15 15 25 40 60 160	175 175 175 175 175 150 150 150	1.70 1.70 1.40 1.40 1.10 1.10 0.80 0.40	X005a X011b X011b X014a X014a X027a X027a X027b	X027a/b SOT-227B/UI miniBLOC

① Non isolated base plate

Schottky Diodes

$$I_{FAV} = 6 - 2x 100 A$$

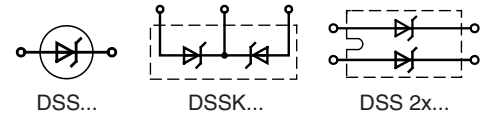

Type	V_{RRM} V	I_{FAV} d = 0.5 A	@ T_C °C	V_F $T_{VJ} = 125^\circ C$ V	@ I_F A	T_{VJM} °C	R_{thJC} K/W	Fig. No.	Package style Outline drawings on pages O-36...O-59
DSS 6-015AS	150	6	160	0.62	6	175	3.0	X004	X004 TO-252AA
DSSK 20-015A		2x 10	165	0.61	10	175	1.4	X005a	
DSSK 50-015A		2x 25	150	0.68	25	175	1.1	X014a	
DSSK 60-015A		2x 30	155	0.66	30	175	0.8	X014a	
DSSK 60-015AR		2x 30	155	0.66	30	175	0.8	X016a	
DSS 2x101-015A		2x 100	110	0.77	100	150	0.4	X027a	X005a TO-220AB
DSSK 10-018A	180	2x 5	165	0.60	5	175	1.7	X005a	
DSSK 30-018A		2x 15	150	0.74	15	175	1.7	X014a	X010a ISOPLUS220™
DSSK 60-02A	200	2x 30	155	0.70	30	175	0.8	X014a	
DSSK 60-02AR		2x 30	155	0.70	30	175	0.8	X016a	
DSS 2x101-02A		2x 100	105	0.84	100	150	0.4	X027a	

HiPerDyn™ FRED

Series connected diodes for high switching frequencies; packages isolated (2500 V_{RMS})

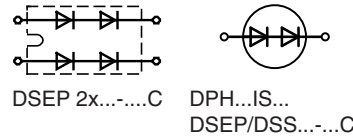

Type	V_{RRM} V	I_{FAV} d = 0.5 A	@ T_C °C	V_F $I_F = I_{FAV}$ V	@ T_{VJ} °C	t_{rr} typ. ns	I_{RM} typ. A	@ -di/dt A/ μ s	T_{VJM} °C	R_{thJC} K/W	Fig. No.
DSS 17-06CR *	600	17	95	2.71	125	45	2.0	100	175	1.40	X016b
DPH 30IS600HI		30	140	1.89	150	35	3.0	200	175	0.55	X016a
DSEP 15-12CR	1200	15	135	2.67	150	15	10.0	600	175	1.00	X016b
DSEP 30-12CR		30	120	3.18	150	15	5.5	600	175	0.60	X016b
DSEP 2x25-12C	1200	2x 25	90	2.95	150	15	5.5	600	150	0.60	X027a
DPJ 50XS1800NA	1800	2x 25	90	4.33	150	15	4.0	600	150	0.40	X016b

* series connected Schottky Diodes

Dual Ultrafast Diodes

Series connected diodes for high switching frequencies with middle connection; packages isolated (2500 V_{RMS})

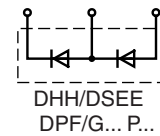

Type	V_{RRM} V	I_{FAV} d = 0.5 A	@ T_C °C	V_F $I_F = I_{FAV}$ V	@ T_{VJ} °C	t_{rr} typ. ns	I_{RM} typ. A	@ -di/dt A/ μ s	T_{VJM} °C	R_{thJC} K/W	Fig. No.
DPG 30P300PJ	2x 300	30	135	0.99	150	35	3	200	175	1.05	X010a
DPG 10P400PJ	2x 400	10	145	1.03	150	45	4	200	175	2.50	X010a
DPG 30P400PJ		30	135	1.05	30	45	4	200	175	1.05	X010a
DSEE 15-12CC	2x 600	15	100	1.50	125	35	4	100	175	1.60	X010a
DSEE 29-12CC		30	90	1.75	125	30	4	100	175	0.90	X010a
DPF 30P600HR		30	130	1.27	150	35	17	600	175	0.90	X016c
① DSEE 30-12A		30	90	1.78	125	30	4	100	175	0.90	X014a
DSEE 55-24N1F	2x 1200	60	110	1.56	150	75	35	600	175	0.60	X024b
DHH 55-36N1F	2x 1800	60	50	2.06	125	230	60	800	150	0.60	X024b

① Non isolated base plate

HiPerFRED2™ Diodes

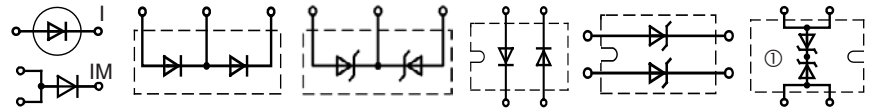

$I_{FAV} = 10 - 2x 120 A$

Type	V_{RRM} V	I_{FAV} d = 0.5		I_{FSM} 10 ms 45°C A	V_F $T_{VJ} = 150°C$ V	$@ I_F$ A	t_{rr} ns	I_{RM} typ. $T_{VJ} = 25°C$ A	$-di/dt$ A/ μ s	T_{VJM} °C	R_{thJC} K/W	Fig. No.	Package style Outline drawings on pages O-36...O-59		
		A	°C												
DPG 10I200PA	200	10	145	140	0.98	10	35	3	200	175	2.30	X005b	X004 TO-252AA		
DPG 10I200PM		10	125	140	0.98	10	35	3	200	175	4.40	X007b			
DPG 20C200PB		2x 10	145	140	0.98	10	35	3	200	175	2.30	X005a			
DPG 20C200PN			125	140	0.98	10	35	3	200	175	4.40	X007a			
DPG 15I200PA		15	140	240	1.01	15	35	3	200	175	1.70	X005b		X005a TO-220AB	
DPG 30C200PB		2x 15	140	240	1.01	15	35	3	200	175	1.70	X005a			
DPG 30C200PC			140	240	1.01	15	35	3	130	175	1.70	X011b			
DPG 30C200HB		2x 15	140	240	1.00	15	35	3	200	175	1.70	X014a			
DPF 60C200HB			130	400	0.98	30	35	4	200	175	0.95	X014a			
DPF 60C200HJ		2x 30	130	560	0.88	30	35	4	200	175	1.05	X016a			
DPG 60C200HB			135	360	1.06	30	35	3	200	175	0.95	X014a			
DPG 60C200QB		2x 30	135	360	1.06	30	35	3	200	175	0.95	X017a			
DPF 80C200HB			140	560	0.95	40	35	4	200	175	0.70	X014a			
DPF 60I200HA		60	135	650	0.98	60	35	4	200	175	0.55	X014b			
DPF 240X200NA		2x 120	120	1800	0.90	120	35	4	200	175	0.45	X027a			
DPG 10I300PA	300	10	145	140	0.98	10	35	3	200	175	2.30	X005b	X007b TO-220ACFP		
DPG 10IM300UC		10	150	140	0.98	10	35	3	200	175	2.30	X004			
DPG 20C300PB		2x 10	145	140	0.98	10	35	3	200	175	2.30	X005a			
DPG 20C300PN			125	140	0.98	10	35	3	200	175	4.40	X007a			
DPG 15I300PA		15	140	240	1.01	15	35	3	200	175	1.70	X005b		X010a ISOPLUS220™	
DPG 30C300PB		2x 15	140	240	1.01	15	35	3	200	175	1.70	X005a			
DPG 30C300PC			140	240	1.01	15	35	3	200	175	1.70	X011b			
DPG 30C300HB		2x 15	140	240	1.00	15	35	3	200	175	1.70	X014a			
DPF 30I300PA			30	145	390	0.98	30	55	6	200	175	0.85		X005b	
DPG 30I300HA		30	135	360	1.06	30	35	3	200	175	0.95	X014b			
DPG 30I300PA			140	360	1.08	30	35	3	200	175	0.85	X005b			
DPG 30IM300PC		30	140	360	1.08	30	35	3	200	175	0.85	X011b			
DPG 30P300PJ		2x 300	30	135	450	0.99	30	35	3	200	175	1.05		X010a	X014a TO-247AD
DPF 60C300HB		2x 30	140	400	0.97	30	55	6	200	175	0.95	X014a			
DPG 60C300HB			135	360	1.06	30	35	3	200	175	0.95	X014a			
DPG 60C300HJ	2x 30	135	450	0.96	30	35	3	200	175	1.05	X016a				
DPG 60C300PC		140	360	1.08	30	35	3	200	175	0.85	X011b				
DPG 60C300QB	2x 30	135	360	1.06	30	35	3	200	175	0.95	X017a				
DPG 80C300HB		135	450	1.07	40	35	3	200	175	0.70	X014a				
DPG 60I300HA	60	125	450	1.10	60	35	3.5	200	175	0.55	X014b				
DPG 60IM300PC	60	135	450	1.14	60	35	3.5	200	175	0.45	X011b				
DPG 120C300QB	2x 60	125	450	1.10	60	35	3.5	200	175	0.55	X017a	X016a ISOPLUS247™			
DPG 10I400PA	400	10	145	150	1.03	10	45	4	200	175	2.30	X005b	X016a ISOPLUS247™		
DPG 10I400PM		10	120	150	1.03	10	45	4	200	175	4.40	X007b			
DPG 10P400PJ		2x 400	10	145	130	1.03	10	45	4	200	175	2.50		X010a	
DPG 20C400PB		2x 10	145	150	1.03	10	45	4	200	175	2.30	X005a			
DPG 20C400PC			145	150	1.03	10	45	4	200	175	2.30	X011b			
DPG 20C400PN		2x 10	120	150	1.03	10	45	4	200	175	4.40	X007a			
DPG 15I400PM			90	190	1.14	15	45	4	200	175	4.20	X007b			
DPG 30C400PB		2x 15	140	190	1.14	15	45	4	200	175	1.70	X005a			
DPG 30C400HB			140	190	1.13	15	45	4	200	175	1.70	X014a			
DPG 30I400HA		30	135	360	1.13	30	45	4	200	175	0.95	X014b			
DPG 30IM400PC		30	145	300	1.16	30	45	4	200	175	0.85	X011b			
DPG 30P400PJ		2x 400	10	135	400	1.05	30	45	4	200	175	1.05		X010a	X017a TO-3P
DPG 60C400HB		2x 30	135	360	1.13	30	45	4	200	175	0.95	X014a			
DPG 60C400QB			135	360	1.13	30	45	4	200	175	0.95	X017a			
DPG 80C400HB		2x 40	135	400	1.14	40	45	4	200	175	0.70	X014a			
DPG 60I400HA	60		120	450	1.22	60	45	4	200	175	0.55	X014b			
DPF 60IM400HB	60	130	600	1.09	60	60	6	200	175	0.55	X014a				
DPG 60IM400QB	60	120	450	1.22	60	45	4	200	175	0.55	X017a				
DPF 240X400NA	2x 120	120	1100	0.95	120	60	6	200	175	0.45	X027a	X027a SOT-227B miniBLOC			
DPH 30IS600HI	600	30	140	450	1.89	30	35	3	200	175	0.55	X016b			

Data according to IEC 60747 and refer to a single diode or thyristor unless otherwise stated.

HiPerFRED™ Diodes

$$I_{FAV} = 8 - 2x 120 A$$

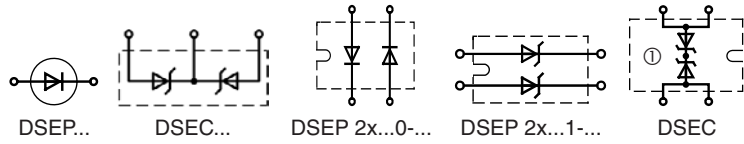





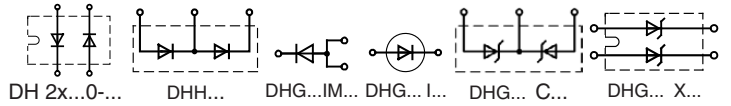

Type	V _{RRM} V	I _{FAV} A d = 0.5	T _C °C	I _{FSM} 10 ms 45°C A	V _F T _{VJ} = 150°C V	@ I _F A	t _{tr} T _{VJ} = 25°C ns	I _{RM} typ. A	-di/dt typ. A/μs	T _{VJM} °C	R _{thJC} K/W	Fig. No.	Package style Outline drawings on pages O-36...O-59
DSEP 40-03AS	300	40	125	340	1.18	40	35	3.5	200	175	0.85	X011b	X004 TO-252AA
DSEP 6-06AS	600	6	150	40	1.34	6	20	3.5	100	175	2.80	X004	X005a TO-220AB
DSEP 6-06BS		6	140	40	1.77	6	15	2.0	100	175	2.80	X004	
DSEP 8-06A		10	145	50	1.42	10	35	3.5	100	175	2.50	X005b	
DSEP 8-06B		10	130	50	1.85	10	30	2.0	100	175	2.50	X005b	
DSEP 15-06A		15	140	110	1.35	15	35	4.0	100	175	1.60	X005b	
DSEP 15-06AS		15	140	110	1.35	15	35	4.0	100	175	1.60	X011b	
DSEP 15-06B		15	130	110	1.59	15	25	2.0	100	175	1.60	X005b	
DSEP 15-06BS		15	130	110	1.59	15	25	2.0	100	175	1.60	X011b	
DSEP 29-06A		30	135	250	1.26	30	35	5.5	100	175	0.90	X005b	
DSEP 29-06AS		30	135	250	1.26	30	35	5.5	100	175	0.90	X011b	
DSEP 29-06B		30	120	250	1.63	30	30	3.0	100	175	0.90	X005b	
DPG 30I600PM		15	95	250	1.63	30	25	4.5	200	175	3.50	X007b	
DSEP 30-06A		30	135	250	1.25	30	35	5.5	100	175	0.90	X014b	
DSEP 30-06B		30	120	250	1.61	30	30	3.0	100	175	0.90	X014b	
DSEP 30-06BR	30	100	250	1.61	30	30	3.0	100	175	1.10	X016b		
DSEP 60-06A	60	110	600	1.39	60	35	5.5	100	175	0.65	X014b		
DSEP 60-06AT	60	110	600	1.39	60	35	5.5	100	175	0.65	X019		
DSEP 75-06AR	75	115	1000	1.38	75	35	6.5	200	175	0.50	X016a		
DSEP 8-12A	1200	10	130	40	1.96	10	40	4.0	100	175	2.50	X005b	
DSEP 12-12A		15	130	90	1.87	15	40	4.5	100	175	1.60	X005b	
DSEP 12-12AZ		15	130	90	1.87	15	40	4.5	100	175	1.60	X011c	
DSEP 12-12B		15	130	90	2.06	15	35	3.0	100	175	1.60	X005b	
DSEP 12-12BZ		15	130	90	2.06	15	35	3.0	100	175	1.60	X011c	
DSEP 29-12A		30	120	200	1.81	30	40	8.5	100	175	0.90	X005b	
DSEP 29-12B		30	100	200	2.31	30	35	5.0	100	175	0.90	X005b	
DSEP 30-12A		30	115	200	1.79	30	40	8.5	100	175	0.90	X014b	
DSEP 30-12B		30	100	200	2.30	30	35	5.0	100	175	0.90	X014b	
DSEP 30-12AR		30	100	200	1.79	30	40	8.5	100	175	1.10	X016b	
DSEP 60-12A		60	85	500	1.81	60	40	8.5	100	175	0.65	X014b	
DSEP 60-12B		60	110	500	2.20	60	35	-	100	175	0.45	X014b	
DSEP 60-12AR		60	60	500	1.81	60	40	8.5	100	175	0.80	X016b	
DSEP 60-12AZ		60	115	500	1.81	60	40	8.5	100	175	0.45	X019a	
DSEP 90-12AZ	90	105	800	1.79	90	40	8.5	100	175	0.35	X019a		
DSEC 16-06A	600	2x 10	145	50	1.42	10	35	3.5	100	175	2.50	X005a	
DSEC 16-06AC		2x 8	85	50	1.20	10	35	3.5	100	175	3.00	X010a	
DSEC 29-06AC		2x 15	140	110	1.34	15	35	4.0	100	175	1.60	X010a	
DSEC 30-06A		2x 15	140	110	1.34	15	35	4.0	100	175	1.60	X014a	
DSEC 30-06B		2x 15	130	110	1.58	15	25	2.0	100	175	1.60	X014a	
DSEC 59-06BC		2x 30	105	200	1.56	30	30	4.0	100	175	1.10	X010a	
DSEC 60-06A		2x 30	135	250	1.25	30	35	5.5	100	175	0.90	X014a	
DSEC 60-06B		2x 30	120	250	1.61	30	30	3.0	100	175	0.90	X014a	
DSEC 16-12A		1200	2x 10	130	40	1.96	10	40	4.0	100	175	2.50	X005a
DSEC 16-12AS			2x 10	130	40	1.96	10	40	4.0	100	175	2.50	X011b
DSEC 30-12A	2x 15		115	90	1.86	15	40	4.5	100	175	1.60	X014a	
DSEC 60-12A	2x 30		115	200	1.79	30	40	8.5	100	175	0.90	X014a	
DSEC 120-12AK	2x 60		85	500	1.81	60	40	7.0	100	175	0.65	X020a	
DSEP 2x31-03A	300	2x 30	110	300	0.90	30	30	4.5	100	150	1.15	X027a	
DSEP 2x61-03A		2x 60	75	600	1.26	60	30	4.0	100	150	0.85	X027a	
DSEP 2x91-03A		2x 90	70	1000	1.10	90	30	4.5	100	150	0.60	X027a	
DSEP 2x31-06A	600	2x 30	95	250	1.23	30	35	5.5	100	150	1.15	X027a	
DSEP 2x31-06B		2x 30	75	250	1.59	30	30	3.0	100	150	1.15	X027a	
DSEP 2x61-06A		2x 60	65	600	1.48	60	35	5.5	100	150	0.85	X027a	
DSEP 2x91-06A		2x 90	55	1000	1.39	90	35	8.0	100	150	0.60	X027a	
DSEP 2x31-12A	1200	2x 30	70	200	1.77	30	40	8.5	100	150	1.15	X027a	
DSEP 2x60-12A		2x 60	80	800	1.52	60	40	8.0	100	150	0.60	X027a	
DSEP 2x61-12A		2x 60	80	800	1.52	60	40	8.0	100	150	0.60	X027a	
DSEP 2x61-12B		2x 60	80	800	2.00	60	35	-	100	150	0.60	X027a	
DSEP 2x101-04A	400	2x 100	45	1000	1.22	125	30	5.5	100	150	0.60	X027a	
① DSEC 240-04A	600	2x 120	75	2000	1.00	120	30	5.5	100	150	0.45	X027b	
① DSEC 240-06A		2x 120	75	2000	1.26	120	35	8.0	100	150	0.40	X027b	

① Non isolated base plate

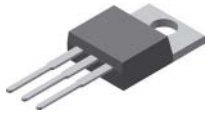
SONIC-FRD™ Diodes

$I_{FAV} = 5 - 2x 60 A$ • ultrasoft and fast recovery
• very low temperature dependence



Type	V_{RRM}	I_{FAV}	@ T_C	I_{FSM}	V_F	@ I_F	t_{rr}	I_{RM}	$-di/dt$	T_{VJM}	R_{thJC}	Fig. No.	Package style
		d = 0.5		10 ms		$T_{VJ} = 125^\circ C$	typ.						Outline drawings on pages O-36...O-59
➤ New	V	A	$^\circ C$	A	V	A	$T_{VJ} = 25^\circ C$	A	A/ μs	$^\circ C$	K/W		
DHG 5I600PA	600	5	105	40	2.17	5	35	2	100	150	3.15	X005b	 X005a TO-220AB  X005b TO-220AC  X007b TO-220ACFP  X011b TO-263AB  X014a TO-247AD  X014b TO-247AD  X017a TO-3P
DHG 5I600PM		5	85	40	2.17	5		2	100		4.20	X007b	
DHG 10C600PB		2x 5	105	40	2.17	5		2	100		3.15	X005a	
DHG 10I600PA		10	95	80	2.18	10		4	200		1.80	X005b	
DHG 10I600PM		10	25	80	2.18	10		4	200		4.00	X007b	
DHG 20C600PB		2x 10	95	80	2.18	10		4	200		1.80	X005a	
DHG 20C600QB		2x 10	95	80	2.17	10		4	200		1.80	X017a	
DHG 20I600PA		20	100	150	2.21	20		8	400		0.80	X005b	
DHG 20I600HA		20	95	150	2.19	20		8	400		0.90	X014b	
DHG 40C600HB		2x 20	95	150	2.19	20		8	400		0.90	X014a	
DHG 30I600PA		30	95	200	2.24	30		12	600		0.60	X005b	
DHG 30IM600PC		30	95	200	2.22	30		12	600		0.60	X011b	
DHG 30I600HA		30	85	200	2.21	30		12	600		0.70	X014b	
DHG 60C600HB		2x 30	85	200	2.21	30		12	600		0.70	X014a	
DHG 60I600HA		60	95	430	2.10	60		24	1200		0.30	X014b	
DHG 50X650NA	650	2x 25	70	200	2.03	25	35	12	600	150	1.20	X027a	
DHG 100X650NA		2x 50	80	430	2.00	50		20	1200		0.60	X027a	
DHG 10I1200PA	1200	10	95	65	2.13	10	75	8	350	150	1.80	X005b	
DHG 10I1200PM		10	30	65	2.13	10		8	350		4.00	X007b	
DHG 20C1200PB		2x 10	95	65	2.13	10		8	350		1.80	X005a	
DHG 20I1200PA		20	105	135	2.16	20		19	750		0.80	X005b	
DHG 20I1200HA		20	95	135	2.14	20		19	750		0.90	X014b	
DHG 40C1200HB		2x 20	95	135	2.14	20		19	750		0.90	X014a	
DHG 50X1200NA		2x 25	70	180	2.00	25		25	1000		1.20	X027a	
DHG 30I1200HA		30	90	180	2.16	30		25	1000		0.70	X014b	
DHG 100X1200NA		2x 50	65	430	2.05	50		50	2500		0.60	X027a	
DHG 60I1200HA		60	95	430	2.22	60		50	2500		0.30	X014b	
DHG 10I1800PA	1800	10	85	65	2.30	10	300	8	200	150	2.15	X005b	
➤ DHG 10IM1800UZ		10	100	60	2.33	10		13	250		1.50	X004a	
DH 20-18A		20	95	150	2.35	20		22	400		0.90	X014b	
DH 40-18A		40	100	400	2.08	40		50	750		0.45	X014b	
DH 60-14A	1400	60	100	700	2.03	60	230	60	800	150	0.30	X014b	
DH 60-16A	1600											X014b	
DH 60-18A	1800											X014b	
DHH 55-36N1F	2x 1800	60	50	700	2.03	60	230	60	800	150	0.60	X024b	
DH 2x60-18A	1800	2x 60	55	700	2.02	60	230	60	800	150	0.60	X027a	
DH 2x61-18A		2x 60	55	700	2.02	60		60	800		0.60	X027a	
DHG 55I3300FE	3300	50	80	600	3.40	60	1650	55	500	150	0.45	X024e	
DHG 40I4500KO	4500	43	80	600	3.50	50	1450	80	800	150	0.50	X022f	

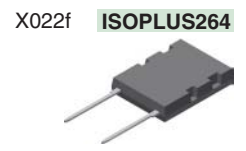
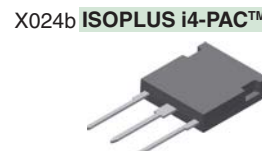
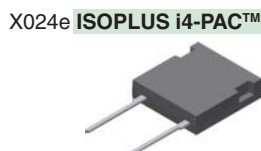

FRED Diodes

Fast Recovery Epitaxial Diodes

$I_{FAV} = 8 - 126 \text{ A}$





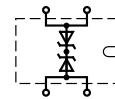



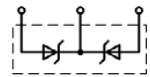



DSEI.../DFE...



DSEK...



DSEK...

Type	V_{RRM} V	I_{FAV} A d = 0.5	@ T_C °C	I_{FRMS} A	I_{FSM} A 10 ms 45°C	V_F V $T_{VJ} = 150°C$	@ I_F A	t_{rr} typ. ns $T_{VJ} = 25°C$	I_{RM} typ. A $T_{VJ} = 100°C$	-di/dt A/μs	R_{thJC} K/W	Fig. No.	Package style Outline drawings on pages O-36...O-59	
DSEI 8-06A	600	8	115	16	100	1.30	8	35	2.5	64	2.50	X005b	TO-220AC 	
DSEI 8-06AS	600	8	115	16	100	1.30	8	35	2.5	64	2.50	X011b		
DFE 10I600PM	600	10	100	16	100	1.30	10	35	2.5	64	4.20	X007b		
DSEI 12-06A	600	14	100	25	100	1.50	16	35	4.0	100	2.00	X005b	TO-220ACFP 	
DSEI 12-06AS	600	14	100	25	100	1.50	16	35	4.0	100	2.00	X011b		
DSEI 12-10A	1000	12	100	25	75	2.10	12	50	6.5	100	1.60	X005b		
DSEI 12-12A	1200	11	100	25	75	2.20	12	50	6.5	100	1.60	X005b		
DSEI 12-12AZ	1200	11	100	25	75	2.20	12	50	6.5	100	1.60	X011c		
DSEI 20-12A	1200	17	85	70	130	1.87	12	40	7.0	100	1.60	X005b		
DSEI 25-06A	600	25	110	35	240	1.55	25	35	9.0	200	1.20	X005b	TO-263AB 	
DSEI 19-06AS	600	20	65	25	100	1.50	16	35	4.0	100	2.00	X011b		
DSEI 25-06AS	600	25	110	35	240	1.55	25	35	9.0	200	1.20	X011b		
DSEI 36-06AS	600	37	85	70	300	1.40	37	35	10.0	240	1.00	X011b		
DFE 25I600HA	600	25	110	70	240	1.52	25	35	9.0	200	1.20	X014b		
DSEI 30-06A	600	37	85	70	300	1.40	37	35	10.0	240	1.00	X014b		
DSEI 30-10A	1000	30	85	70	200	2.00	36	35	16.0	240	0.90	X014b		
DSEI 30-10AR	1000	30	85	70	200	2.00	36	35	16.0	240	0.90	X016b		
DSEI 30-12A	1200	26	85	70	200	2.20	30	40	16.0	240	0.90	X014b		
DSEK 60-02A	200	2x 34	115	50	325	0.85	30	35	4.0	100	1.00	X014a		TO-263ABHV 
DSEK 60-02AR	200	2x 34	115	50	325	0.85	30	35	4.0	100	1.00	X016a		
DSEK 60-06A	600	2x 30	85	50	300	1.40	37	35	10.0	240	1.00	X014a	TO-247AD 	
DSEK 60-12A	1200	2x 26	85	50	200	2.20	30	40	16.0	240	0.90	X014a		
DSEI 60-02A	200	69	85	98	600	0.88	60	35	8.0	200	0.75	X014b		
DSEI 60-06A	600	60	70	100	550	1.50	70	35	19.0	480	0.75	X014b		
DSEI 60-10A	1000	60	60	100	500	1.80	60	35	32.0	480	0.66	X014b	TO-247AD 	
DSEI 60-12A	1200	52	60	100	500	2.00	60	40	32.0	480	0.66	X014b		
DSEI 120-06A	600	126	70	100	600	1.12	70	35	17.0	200	0.35	X014b		
DSEI 120-12A	1200	109	60	100	600	1.55	70	40	25.0	200	0.35	X014b		
DSEI 120-12AZ	1200	109	60	100	600	1.55	70	40	25.0	200	0.35	X019a		
X019a	TO-268AAHV 		X017b		TO-3P 		X016b		ISOPLUS247™ 		X016a		ISOPLUS247™ 	

FRED Diodes

Fast Recovery Epitaxial Diodes

$I_{FAV} = 2x\ 28\ A - 2x\ 165\ A$

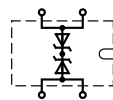

DSEK...

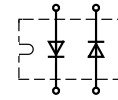

DSEI 2x...0-...

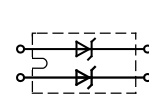

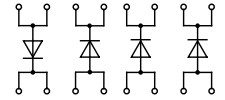

DSEI 2x...1-...



2x...0-...

2x...1-...

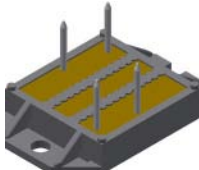
Type	V_{RRM}	I_{FAV} d = 0.5	@ T_C	I_{FRMS}	I_{FSM} 10 ms 45°C	V_F $T_{VJ} = 150^\circ C$	@ I_F	t_{rr} typ. $T_{VJ} = 25^\circ C$	I_{RM} typ. $T_{VJ} = 100^\circ C$	-di/dt	R_{thJC}	Fig. No.	Package style Outline drawings on pages O-36...O-59
➤ New	V	A	°C	A	A	V	A	ns	A	A/μs	K/W		
① DSEK 300-06A	600	2x 150	105	270	2000	1.20	150	77	50	600	0.20	X027d	 <p>SOT-227B miniBLOC</p>
DSEI 2x30-04C	400	2x 30	85	70	300	1.40	30	35	10	240	1.25	X027a	
DSEI 2x30-06C	600	2x 30	85	70	300	1.40	30	35	10	240	1.25	X027a	
DSEI 2x30-10B	1000	2x 30	50	70	200	2.00	30	35	16	240	1.25	X027a	
DSEI 2x30-12B	1200	2x 28	50	70	200	2.20	30	40	16	240	1.25	X027a	
DSEI 2x31-04C	400	2x 30	85	70	300	1.40	30	35	10	240	1.25	X027a	
DSEI 2x31-06C	600	2x 30	85	70	300	1.40	30	35	10	240	1.25	X027a	
DSEI 2x31-10B	1000	2x 30	50	70	200	2.00	30	35	16	240	1.25	X027a	
DSEI 2x31-12B	1200	2x 28	50	70	200	2.20	30	40	16	240	1.25	X027a	
DSEI 2x61-02A	200	2x 71	85	100	950	0.88	60	35	8	200	0.80	X027a	
DSEI 2x60-04C	400	2x 60	70	100	550	1.50	60	35	19	480	0.70	X027a	
DSEI 2x61-04C	400	2x 60	70	100	550	1.50	60	35	19	480	0.70	X027a	
DSEI 2x61-06C	600	2x 60	70	100	550	1.50	60	35	19	480	0.70	X027a	
DSEI 2x61-10B	1000	2x 60	50	100	500	1.80	60	35	32	480	0.70	X027a	
DSEI 2x61-12B	1200	2x 52	50	100	450	2.15	60	40	32	480	0.70	X027a	
DSEI 2x61-06P	600	2x 60	70	100	550	1.50	60	35	19	480	0.70	X101	
DSEI 2x61-12P	1200	2x 52	50	100	450	2.15	60	40	32	540	0.70	X101	
DSEI 2x121-02A	200	2x 123	70	150	1200	0.95	120	35	12	200	0.50	X027a	 <p>SOT-227UI miniBLOC</p>
DSEI 2x101-06A	600	2x 96	70	150	1200	1.17	100	35	19	200	0.50	X027a	
DFE 240X600NA	600	2x 120	80	150	1200	1.20	120	35	27	600	0.40	X027a	
➤ DFE 250X600NA	600	2x 125	80	150	1300	1.16	125	35	27	600	0.40	X027a	
DSEI 2x101-12A	1200	2x 91	50	130	900	1.61	100	40	24	200	0.50	X027a	
DSEI 2x101-06P	600	2x 96	70	150	1200	1.17	100	40	19	200	0.50	X102	
DSEI 2x101-12P	1200	2x 91	50	130	900	1.61	100	40	24	200	0.50	X102	
DSEI 2x161-02P	200	2x 165	70	270	1200	1.05	200	35	20	200	0.29	X102	 <p>ECO-PAC 1</p>
DSEI 2x161-06P	600	2x 147	70	270	1200	1.40	200	35	45	200	0.29	X102	
DSEI 2x161-12P	1200	2x 128	70	270	1200	1.75	200	40	48	200	0.29	X102	

① non isolated base plate

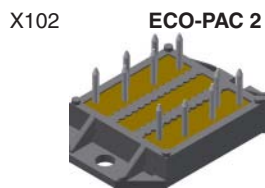

See data sheet for pin arrangement

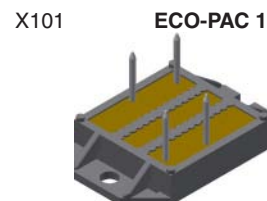

See data sheet for pin arrangement

FRED & HiPerFRED™ Modules

$I_{FAV} = 75 - 582 \text{ A}$

Type	V_{RRM}	I_{FAV}	@ T_C	I_{FRMS}	I_{FSM}	V_F	@ I_F	t_{rr}	I_{RM}	$-di/dt$	R_{thJC}	P_{tot}	Fig. No.	Package style
	V	A	°C	A	A	V	A	ns	A	A/ μ s	K/W	W		Outline drawings on pages O-36...O-59
FRED														
MEO 550-02DA	200	582	75	822	4800	1.08	520	150	15	200	0.071	1750	X126d	X125e TO-240
MEO 500-06DA	600	514		726		1.41		250	132	800				
MEO 450-12DA	1200	453		640		1.76		450	165	800				
MEK 75-12DA	1200	2x 75	107	1200	1.85	100	250	33	200	0.450	280	X125e		
MEA 75-12DA	1200	2x 75												
MEE 75-12DA	2x 1200	75												
MEK 95-06DA	600	2x 95	142	1200	1.36	100	250	21	200	0.450	280			
MEA 95-06DA	600	2x 95												
MEE 95-06DA	2x 600	95												
MEK 250-12DA	1200	2x 260	367	2400	1.54	260	450	83	400	0.143	875	X126c		
MEA 250-12DA	1200	2x 260												
MEE 250-12DA	2x 1200	260												
MEK 300-06DA	600	2x 304	430	2400	1.19	260	250	66	400	0.143	875			
MEA 300-06DA	600	2x 304												
MEE 300-06DA	2x 600	304												
MEK 350-02DA	200	2x 356	503	2400	0.92	260	150	15	200	0.143	875			
HiPerFRED™														
MEK 150-04DA	400	2x 150	100	200	1200	1.40*	300	300	11	100	0.350	360	X125e	
MEK 600-04DA	400	2x 575	80	800	3000	1.10	400	220	80	900	0.110	1100	X126c	
MPK 95-06DA	600	2x 95	110	200	1200	1.40	100	35	5.5	100	0.575	215	X125e	

* $T_{VJM} = 150^\circ\text{C}$

Diode connections for Fig. X125 (TO-240)

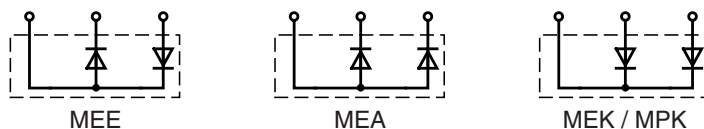

Diode connections for Fig. X126 (Y4: 34 mm package)

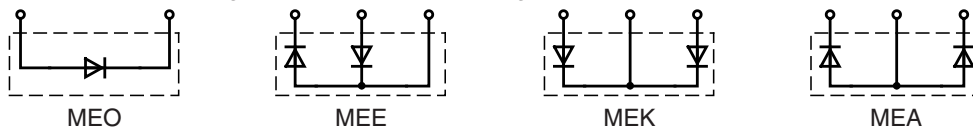

SemiFast Diodes

$I_{FAV} = 60 \text{ A}$

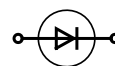

DSDI...

Type	V_{RRM}	I_{FAV}	@ T_C	I_{FRMS}	I_{FSM}	V_F	@ I_F	t_{rr}	I_{RM}	$-di/dt$	R_{thJC}	Fig. No.	Package style
	V	A	°C	A	A	V	A	ns	A	A/ μ s	K/W		
DSDI 60-14A	1400	63	60	100	500	4.1	70	300	60	500	0.4	X014b	TO-247AD
DSDI 60-16A	1600												
DSDI 60-18A	1800												

Rectifier Diodes

$I_{FAV} = 2 - 30 \text{ A}$,
Standard & Avalanche Rectifier



DAA...EM...

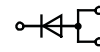



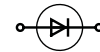

DLA...IM...
DMA...IM...

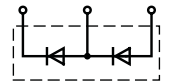

DS/DSA/DSI
DMA...I...
DLA...I...



DSP
DMA...P...
DLA...P...

Type	V_{RRM}	I_{FAV}	@ T_C	P_{RSM}	I_{FRMS}	I_{FSM}	V_{F0}	r_F	T_{VJM}	R_{thJC}	R_{thCH}	Fig. No.	Package style
	V	A	$^{\circ}\text{C}$	kW	A	A	V	m Ω	$^{\circ}\text{C}$	K/W	K/W		Outline drawings on pages O-36...O-59
DSA 1-12D DSA 1-16D DSA 1-18D	1200 1600 1800	2.3	T_{amb} 45	1.6	7	110	0.80	67.0	150	R_{thJA} 80		X201 X201 X201	X004 TO-252AA 
DLA 5P800UC	2x 800	5	140	-	20	40	0.74	44.0	175	5.50	0.50	X004	
DSP 8-08S DSP 8-12S	2x 800 2x 1200	8	160	-	25	100	0.79	33.0	175	1.50	0.25	X011b X011b	
DSP 8-08A DSP 8-12A	2x 800 2x 1200											X005a X005a	
DSP 8-08AS DSP 8-12AS	2x 800 2x 1200											X011a X011a	X004a TO-252AA 
DLA 10IM800UC DLA 20IM800PC	800	10	100	-	20	80	0.80	22.0	175	3.15	0.50	X004 X011b	
DMA 10IM1200UZ DMA 10IM1600UZ	1200 1600	10	150	-	20	120	0.82	37.0	175	1.50	0.50	X004a X004a	
DMA 10P1200UZ DMA 10P1600UZ	1200 1600	10	140	-	20	100	0.90	37.0	175	2.00	0.50	X004a X004a	X005a TO-220AB 
DMA 10I1600PA DMA 10IM1600PZ	1600 1600	10	150	-	20	120	0.82	37.0	175	1.50	0.50 0.25	X005b X011c	
DMA 10P1600PZ DMA 10P1800PZ	2x 1600 2x 1800											X011c X011c	
DAA 10EM1800PZ DAA 10P1800PZ	1800 2x 1800	10	150	1.6	25	150	0.81 0.82	32.0 37.0	175 175	1.50 1.50	0.25 0.25	X011c X011c	X005b TO-220AC 
DMA 10P1200HR DMA 10P1600HR	2x 1200 2x 1600	10	145	-	25	120	0.81	34.0	175	2.00	0.25	X016c X016c	X005b
DSP 25-12A DSP 25-16A	2x 1200 2x 1600	25	135	-	70	300	0.81	13.8	175	0.90	0.25	X014a X014a	
DSP 25-12AT DSP 25-16AT	2x 1200 2x 1600										0.15	X019 X019	
DSP 25-16AR	2x 1600	25	110	-	70	300	0.81	13.8	175	1.50	0.25	X016a	
DSI 30-08A DSI 30-12A DSI 30-16A	800 1200 1600	30	130	-	35	300	0.82	14.9	175	0.90	0.50	X005b X005b X005b	X011a TO-263AA 
DSI 30-08AS DSI 30-12AS DSI 30-16AS	800 1200 1600										0.25	X011b X011b X011b	

X014a **TO-247AD**



X011c **TO-263ABHV**



X011b **TO-263AB**



X016a **ISOPLUS247™**



X201

FP-case



X016c

ISO247™



X019

TO-268AA



Rectifier Diodes

$I_{FAV} = 30 - 2 \times 100 \text{ A}$,
Standard & Avalanche Rectifier

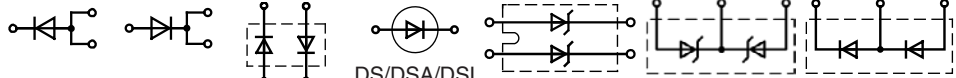

DLA...IM... DNA...EM... DMA...XA... DMA...E/I... DSI 2x... DSIK DSP
DMA...IM... DAA...EM... DAA...XA... DLA...I... DA/MA...X... DA/MA...P...



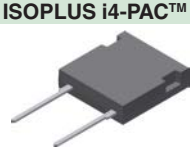
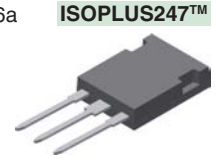
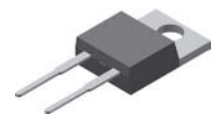





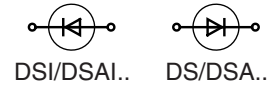





Type	V_{RRM}	I_{FAV}	@ T_C	P_{RSM}	I_{FRMS}	I_{FSM}	V_{FO}	r_F	T_{VJM}	R_{thJC}	R_{thCH}	Fig. No.	Package style
➤ New	V	A	°C	kW	A	A	V	mΩ	°C	K/W	K/W		Outline drawings on pages O-36...O-59
DMA 30IM1600PZ	1600	30	140	-	35	300	0.82	14.1	175	0.70	0.25	X011c	X005b TO-220AC
DMA 30E1800HA	1800	30	140	-	70	370	0.88	12.1	175	0.70	0.25	X014b	
DMA 30P1200HB	2x 1200	30	130	-	70	370	0.81	12.7	175	0.80	0.25	X014a	
DMA 30P1600HB	2x 1600										0.25	X014a	
DMA 30P1600HR	2x 1600	30	105	-	50	300	0.82	13.5	175	1.30	0.25	X016c	X008b TO-262AA (I ² -PAK)
DNA 30ER2200IY	2200	30	140	-	35	370	0.88	12.9	175	0.70	0.50	X008b	
DNA 30E2200PA											0.25	X005b	
DNA 30E2200PZ												0.25	
DNA 30EM2200PZ												0.25	X011c
DNA 30E2200FE	2200	30	100	-	70	370	0.88	12.2	175	1.35	0.20	X024e	X011b TO-263AB
DLA 40IM800PC	800	40	130	-	35	300	0.81	8.0	175	0.80	0.25	X011b	
DSI 45-08A	800	45	130	-	70	480	0.81	9.1	175	0.55	0.25	X014b	
DSI 45-12A	1200											X014b	
DSI 45-16A	1600											X014b	
DSP 45-12A	2x 1200	45	130	-	70	480	0.81	9.1	175	0.55	0.25	X014a	X011c TO-263ABHV
DSP 45-12AZ											0.15	X019a	
DSP 45-16A	2x 1600										0.25	X014a	
DSP 45-16AZ											0.15	X019a	
DSP 45-18A	2x 1800										0.25	X014a	
DSI 45-16AR	1600	45	100	-	70	480	0.81	9.1	175	0.90	0.25	X016b	X011c TO-263ABHV
DSIK 45-16AR	1600	2x 45										X016a	
DSP 45-16AR	2x 1600	45										X016a	
DMA 50I800HA	800	50	130	-	70	500	0.81	8.6	175	0.45	0.25	X014b	X014a TO-247AD
DMA 50I1200HA	1200											X014b	
DMA 50I1600HA	1600											X014b	
DMA 50P1200HR	2x 1200	50	105	-	70	500	0.82	9.0	175	0.70	0.25	X016c	
DMA 50P1200HB	2x 1200	50	130	-	70	500	0.81	8.6	175	0.45	0.25	X014a	
DMA 50P1600HB	2x 1600											X014a	
DLA 60I1200HA	1200	60	150	-	70	850	0.77	4.2	175	0.30	0.25	X014b	X014a TO-247AD
DMA 80IM1600HB	1600	80	125	-	70	1300	0.82	4.8	175	0.35	0.25	X014a	
➤ DLA 100IM1200TZ	1200	100	105	-	70	1300	0.85	4.6	175	0.35	0.15	X019a	
DSI 2x55-12A	1200	2x 60	95	-	120	800	0.83	6.2	150	0.60	0.10	X027a	
DSI 2x55-16A	1600											X027a	
DNA 120E2200KO	2200	120	125	-	70	2000	0.75	3.8	175	0.25	0.15	X022f	X014b TO-247AD
DMA 150E1600NA	1600	150	90	-	150	3000	0.83	2.0	150	0.25	0.10	X027a	
DMA 200X1600NA	1600	2x100	100	-	150	1500	0.80	4.0	150	0.30	0.10	X027a	
DMA 200XA1600NA												X027a	
DAA 200X1800NA	1800											X027a	
DAA 200XA1800NA												X027a	



Rectifier Diodes

$I_{FAV} = 3 - 110 \text{ A}$, Standard Diodes (DS..), Avalanche Diodes (DSA..)



Type	V_{RRM}	I_{FAV}	@ T_C	P_{RSM}	I_{FRMS}	I_{FSM} 10 ms 45°C	V_{FO}	r_F	T_{VJM}	R_{thJC}	R_{thCH}	Symbol	Fig. No.	Package style
○ Not for new design	V	A	°C	kW	A	A	V	mΩ	°C	K/W	K/W			Outline drawings on pages O-36...O-59
○ DS 2-12A	1200	3.6	T_{amb}	-	7	120	0.85	43.0	180	R_{thJA}			X200	X200 Metal-can 
○ DSA 2-12A	1200		45	2.5						R_{thJA}			X200	
○ DSA 2-16A	1600												X200	
○ DSA 2-18A	1800												X200	
○ DSA 9-12F	1200	11	100	4.5	18	250	0.85	15.0	180	2.00	1.00		X204	X204 DO-203AA (DO-4) M5 
○ DSA 9-16F	1600												X204	
○ DSA 9-18F	1800												X204	
○ DS 17-12A	1200	25	125	-	40	370	0.85	8.0	180	1.50	0.60		X205	X205 DO-203AA (DO-4) 10-32 UNF 
○ DSA 17-12A	1200	25	125	7	40	370	0.85	8.0	180	1.50	0.60		X205	
○ DSA 17-16A	1600												X205	
○ DSA 17-18A	1800												X205	
○ DSI 17-12A	1200	25	125	-	40	370	0.85	8.0	180	1.50	0.60		X205	X205 DO-203AA (DO-4) 10-32 UNF 
○ DSAI 17-12A	1200	25	100	7	40	370	0.85	8.0	180	1.50	0.60		X205	
○ DSAI 17-16A	1600												X205	
○ DSAI 17-18A	1800												X205	
○ DS 35-12A	1200	49	100	-	80	650	0.85	4.5	180	1.05	0.20		X206a	X206a DO-203AB (DO-5) 
○ DSA 35-12A	1200	49	100	11	80	650	0.85	4.5	180	1.05	0.20		X206a	
○ DSA 35-16A	1600												X206a	
○ DSA 35-18A	1800												X206a	
○ DSI 35-12A	1200	49	100	-	80	650	0.85	4.5	180	1.05	0.20		X206a	X206a DO-203AB (DO-5) 
○ DSAI 35-12A	1200	49	100	11	80	650	0.85	4.5	180	1.05	0.20		X206a	
○ DSAI 35-16A	1600												X206a	
○ DSAI 35-18A	1800												X206a	
○ DS 75-12B	1200	110	100	-	160	1400	0.75	2.0	180	0.50	0.40		X207	X207 DO-203AB (DO-5) 
○ DSA 75-12B	1200	110	100	20	160	1400	0.75	2.0	180	0.50	0.40		X207	
○ DSA 75-16B	1600												X207	
○ DSA 75-18B	1800												X207	
○ DSI 75-12B	1200	110	100	-	160	1400	0.75	2.0	180	0.50	0.40		X207	X207 DO-203AB (DO-5) 
○ DSAI 75-12B	1200	110	100	20	160	1400	0.75	2.0	180	0.50	0.40		X207	
○ DSAI 75-16B	1600												X207	
○ DSAI 75-18B	1800												X207	

Phase Control Thyristors

$I_{TAV} = 25 - 63 \text{ A}$



Type	V_{RRM} V_{DRM}	I_{TAV} $T_C = 85^\circ\text{C}$	$I_{T(RMS)}$	I_{TSM} 45°C 10 ms	$(dv/dt)_{cr}$	V_{TO}	r_T	T_{VJM}	R_{thJC}	R_{thCH}	Fig. No.
	V	A	A	A	V/μs	V	mΩ	°C	K/W	K/W	
○ CS 23-08io2	800	25	50	450	1000	1.00	10.0	125	1.00	0.60	X209
○ CS 23-12io2	1200										X209
○ CS 23-16io2	1600										X209
○ CS 35-08io4	800	63	120	1200	1000	0.85	3.5	125	0.40	0.20	X210
○ CS 35-12io4	1200										X210
○ CS 35-14io4	1400										X210

X209 TO-208AC (TO-48)



X210 TO-208AC (TO-65)



Phase Control Thyristors

Thyristors are very rugged devices. Compared to all other controlled semiconductor components, they feature the highest current capacity per chip area especially at high voltage. They are mainly used as control devices in 50 and 60 Hz AC mains equipment.

Principal applications are static converter circuits for speed control of DC-drives, or switching and control functions for temperature, lighting, soft-start, etc. in single-phase and three-phase AC switch configurations. Phase control thyristors are designed for optimal forward conduction and reverse blocking characteristics, due to only moderate requirements for turn-on and turn-off parameters.

Phase Control Thyristors

$I_{TAV} = 5 - 30 \text{ A}$



CLB...



CS.../CL/MA...E/...

Type	V_{RRM} V_{DRM}	I_{TAV}	@ T_C	$I_{T(RMS)}$	I_{TSM} 45°C 10 ms	$(dv/dt)_{cr}$	V_{TO}	r_T	T_{VJM}	R_{thJC}	R_{thCH}	Fig. No.	Package style
	V	A	°C	A	A	V/μs	V	mΩ	°C	K/W	K/W		Outline drawings on pages O-36...O-59
CLA 5E1200UC CLA 5E1200PZ	1200	5	135	8	70	500	0.89	85.0	150	1.50	0.50	X004 X011c	X004 TO-252AA
CLA 15E1200NPB CLA 15E1200NPZ	1200	15	120	33	170	500	0.89	30.0	150	0.95	0.50	X005a X011c	X005a TO-220AB
CLA 16E800PN CLA 16E1200PN	800 1200	10	90	16	180	500	0.81	24.0	150	4.00	0.50	X007a X007a	X007a TO-220ABFP
CS 19-08ho1 CS 19-12ho1 CS 19-08ho1S CS 19-12ho1S	800 1200 800 1200	20	110	31	160	500	0.86	22.0	150	0.70	0.50	X005a X005a X011b X011b	X007a TO-220ABFP
CMA 20E1600PB CMA 20E1600PZ	1600	20	115	31	180	500	0.92	28.0	150	0.70	0.50	X005a X011c	X011b TO-263AB
CS 20-12io1 CS 20-14io1 CS 20-16io1	1200 1400 1600	20	130	31	260	1000	0.87	17.3	150	0.60	0.25	X014a X014a X014a	X011b TO-263AB
CS 20-22moF1 CS 20-25mo1F	2200 2500	18	85	28	200	2500	0.97	17.0	125	0.92	0.15	X024c X024c	X011c TO-263ABHV
CS 20-25moT1	2500	18	85	28	200	2500	0.97	17.0	125	0.80	0.15	X019	X011c TO-263ABHV
CS 22-08io1M CS 22-12io1M	800 1200	16	90	25	300	500	0.86	13.2	150	2.50	0.50	X007a X007a	X014a TO-247AD
CLA 30E1200PB CLA 30E1200PC CLA 30E1200NPZ ➤ CLA 100E1200TZ ★ CLB 30I1200PZ	1200	30	115	47	300	500	0.86	13.2	150	0.50	0.50	X005a X011b X011c X019a X011c	X014a TO-247AD
CLA 30E1200HB ★ CLB 30I1200HB	1200	30	120	47	300	500	0.86	12.5	150	0.50	0.25	X014a X014a	X016c ISO247™
CMA 30E1600PB CMA 30E1600PZ CMA 30E1600PN	1600 1600 1600	30	115 40	47	260	500	0.92 0.92 0.92	18.0 18.0 18.0	150	0.75 0.75 2.50	0.50 0.25 0.50	X005a X011c X007a	X019 TO-268AA
CS 30-12io1 CS 30-14io1 CS 30-16io1	1200 1400 1600	30	120	47	400	1000	0.87	14.2	150	0.50	0.25	X014a X014a X014a	X019 TO-268AA
CMA 30P1600FC	2x 1600	30	90	47	400	1000	0.87	14.2	150	1.00	0.25	X024a	X024c ISOPLUS i4-PAC™
CLA 40E1200NPZ	1200	40	125	63	520	500	0.85	9.9	150	0.40	0.25	X011c	
CLA 40E1200NHB	1200	40	120	63	520	500	0.85	9.2	150	0.50	0.25	X014a	
CLA 40E1200HR	1200	40	95	63	650	1000	0.85	7.9	150	0.80	0.25	X016c	
★ CLB 40I1200PZ	1200	40	125	63	520	500	0.85	9.9	150	0.40	0.25	X011c	
CLA 40P1200FC	2x 1200	40	95	63	650	1000	0.86	7.9	150	0.80	0.20	X024a	
CMA 40E1600HR	1600	40	90	63	550	1000	0.81	9.8	150	0.80	0.25	X016c	

★ Anode gated

Phase Control Thyristors

$I_{TAV} = 30 - 100 \text{ A}$

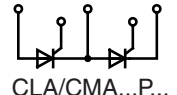

Type	V_{RRM} V_{DRM}	I_{TAV}	@ T_C	$I_{T(RMS)}$	I_{TSM} 45°C 10 ms	$(dv/dt)_{cr}$	V_{TO}	r_T	T_{VJM}	R_{thJC}	R_{thCH}	Fig. No.	Package style
➤ New	V	A	°C	A	A	V/μs	V	mΩ	°C	K/W	K/W		Outline drawings on pages O-36...O-59
CS 45-08io1	800	45	110	71	520	1000	0.88	11.0	150	0.40	0.25	X014a	X005a TO-220AB
CS 45-12io1	1200											X014a	
CS 45-16io1	1600											X014a	
CS 45-16io1R	1600	45	80	71	520	1000	0.88	11.0	150	0.80	0.25	X016a	
CLA 50E1200HB	1200	50	125	79	650	1000	0.88	7.7	150	0.25	0.25	X014a	X011b TO-263AB
CLA 50E1200TC										0.15		X019	
CMA 50E1600HB	1600	50	110	79	550	1000	0.83	9.6	150	0.40	0.25	X014a	X011c TO-263ABHV
CMA 50E1600QB												X017a	
CMA 50E1600TZ										0.15		X019a	
CMA 50P1600FC	2x 1600		90	79	720	1000	0.88	6.7	150	0.70	0.20	X024a	
CS 60-12io1	1200	60	110	75	1400	1000	0.82	5.3	140	0.32	0.15	X015a	X011c TO-263ABHV
CS 60-14io1	1400											X015a	
CS 60-16io1	1600											X015a	
➤ CS 60-16io1R	1600	60	90	75	1400	1000	0.82	5.3	140	0.45	0.15	X016a	
CLA 80E1200HF	1200	80	115	126	900	1000	0.88	6.3	150	0.20	0.25	X015a	X014a TO-247AD
CMA 80E1600HB	1600	80	115	126	720	1000	0.90	6.4				X014a	
CLA 100E1200HB	1200	100	105	160	1100	1000	0.82	5.2	150	0.20	0.15	X014a	X014a TO-247AD
CLA 100E1200KB												X020a	
➤ CLA 100E1200TZ												X019a	

Fast Phase Control Thyristors

CLE 20E1200PC	1200	20	115	31	160	500	0.92	24	150	0.70	0.25	X011b	X015a PLUS247
CME 30E1600PZ	1600	30	105	47	280	500	0.96	25	150	0.50	0.25	X011c	
CLF 20E1200PB	1200	20	110	31	150	500	0.96	26	150	0.70	0.50	X005a	X016a ISOPLUS247™
CLE 30E1200PB	1200	30	115	47	270	500	0.92	14	150	0.50	0.50	X005a	
CLE 40E1200HB	1200	40	130	63	600	1000	0.97	9	150	0.25	0.25	X014a	
CNE 60E2200TZ	2200	60	80	94	720	1000	1.90	12.6	150	0.30	0.15	X019a	
CLE 90UH1200TLB	1200	90	90	-	350	500	0.92	13	150	0.90	0.40	X030a	

Triode - Reverse Conducting Thyristor



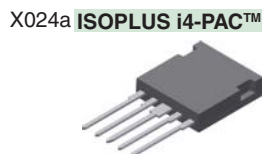
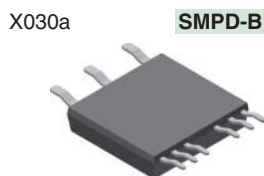

Type	V_{RRM}	V_{VRMS}	I_{TAV}	@ T_C	I_{TSM} 10 ms 45°C	V_{TO}	r_T	T_{VJM}	R_{thJC}	R_{thCH}	Fig. No.
	V	V	A	°C	A	V	mΩ	°C	K/W	K/W	
CLA 20EF1200PB	1200	400	20	115	120	0.90	25	150	0.65	0.50	X005a
CLA 20EF1200PZ											X011c



Thyristors, SCRs

(SCR = Silicon Controlled Rectifier)

Littelfuse SCR products are half-wave, Silicon-Controlled Rectifiers that represent the state of the art in design and performance. Because of its unidirectional switching capability, the SCR is used in circuits where high surge currents or latching action is required. It may also be used for half-wave-type circuits where gate-controlled rectification action is required. Applications include crowbars in power supplies, camera flash units, smoke alarms, motor controls, battery chargers, and engine ignition.

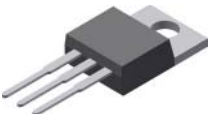
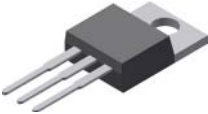
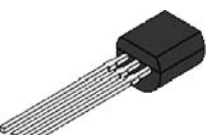
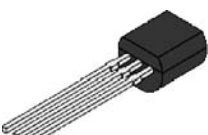
Type	V_{DRM} V_{RRM}	I_{TAV}	$I_{T(RMS)}$	@ T_C	I_{TSM} 20 ms	I_{GT} QI-QII-QIII (-QIV)	T_J	Fig. No.	Package style
▶ New	V	A	A	°C	A	A	°C		Outline drawings on pages O-60...O-64
S8X5ECSR	800	0.3	0.5	85	20	0.1	125	L006a	L001 SOT-223 
S6X8BBSR	600	0.51	0.8	80	10	0.2	125	L015	
S8X8TSR	800	0.51	0.8	60	8	0.2	125	L001	
S601ERP	600	0.64	1	90	25	10	125	L006a	
S602ECSR	600	0.95	1.5	65	14	0.1	125	L006a	
S602TSR	600	0.95	1.5	95	12.5	0.2	125	L001	
S802ECSR	800	0.95	1.5	65	20	0.1	125	L006a	L002 TO-218AC 
S6002TSR	600	1.2	2	95	22.5	0.2	125	L001	
SJ6004DS2RP	600	2.5	4	130	25	0.2	150	L004	L002a TO-218X 
S6004DS2RP	600	2.5	4	95	25	0.2	125	L004	
SJ6008DS2RP	600	5.1	8	120	83	0.2	150	L004	
SJ6008DRP	600	5.1	8	125	83	15	150	L004	
S8008DRP	800	5.1	8	110	83	15	125	L004	L004 TO-252AA 
SJ6012DRP	600	7.6	12	125	100	20	150	L004	
SJ6012NRP	600	7.6	12	135	100	20	150	L011b	
S8015LTP	800	9.5	15	90	188	30	125	L005c	L005a TO-220AB 
▶ SV6016R2TP	600	10	16	135	188	10	150	L005a	
▶ SV6020R2TP	600	12.8	20	130	225	10	150	L005a	
SJ6025L2TP	600	16	25	100	300	10	150	L005c	
SJ6025R2TP	600	16	25	125	300	10	150	L005a	
▶ SV6025L2TP	600	16	25	100	300	10	150	L005c	
▶ SV6025R2TP	600	16	25	125	300	10	150	L005a	L005c TO-220AB (ISO) 
S8025LTP	800	16	25	75	300	35	125	L005c	
S8025RTP	800	16	25	100	300	35	125	L005a	
SK025NRP	1000	16	25	100	300	35	125	L011b	L006b TO-92 (GAK) 
SJ6040N2RP	600	25	40	120	430	15	150	L011b	
SJ6040LTP	600	25	40	55	430	40	150	L005c	
SJ6040RTP	600	25	40	120	430	40	150	L005a	
S8040RTP	800	25	40	100	430	40	125	L005a	
S8055RTP	800	35	55	90	550	40	125	L005a	
S8065JTP	800	41	65	75	800	50	125	L002a	L006a TO-92 
SK065KTP	1000	41	65	75	800	50	125	L002	

L015

SOT-23



L011b

TO-263AB



L006b

TO-92 (GAK)

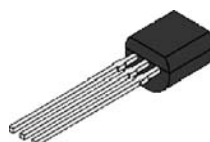

L006a

TO-92

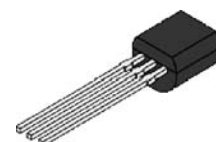

Thyristor / Diode Modules

One of the essential advantages of power semiconductor modules compared to discrete designs is the electrical isolation between the baseplate of the module and the parts subject to voltage (3.6 - 4.8 kV_{RMS} tested). This makes possible the mount-down of any number of the same or different modules on a common heatsink. It is feasible to use standard housings with appropriate accessories for designing compact power converter operating from AC mains up to 690 V.

Plastic Housing with DCB Substrate

IXYS has succeeded in simplifying the conventional multilayer module construction by the DCB (Direct Copper Bonding) technique.

Other features are:

- top-side electrical terminals with captured nuts;
- series-connected diode/diode, thyristor/ diode and thyristor/thyristor modules;
- easy assembly.

All thyristor modules with DCB ceramic base contacts are available in volume with two standardized twin

plugs (2.8 mm x 0.8 mm) for gate and auxiliary cathode control terminals (version 1). Modules in TO-240 housing of the version 8 are delivered with gate plugs only (without auxiliary cathode terminal; mounting screws available on request). The module housing is designed for adequate clearance and creepage distance resulting in  recognition by Underwriters Laboratories, Inc., USA for all types.

New Generation Silicon Chips

All chips are designed by applying separation diffusion processes such that the zones responsible for the surface field strength are located at the upper chip side. This results in the capability of soldering the entire chip area onto the DCB ceramic substrate without a molybdenum strain buffer, which in turn leads to good stability of the chips as well as to large area heat dissipation if a load is applied. All zones at the edges which are decisive for the blocking stability are coated with passivation glasses the coefficient of expansion of which match that of silicon. Silicon chips increasingly use planar technology with guard rings and channel stoppers to reduce electrical surface fields. This chip design supercedes the design of thyristor chips which

were fabricated with passivation masks so that modules of the new series designed with the updated state-of-the-art utilize planar passivated chips processed by separation diffusion techniques. The contact areas of the chips possess physical vapor deposited metal layers. For the user the improved properties are:

- Excellent long-term stability of blocking currents and blocking voltages,
- increased life time of the internal soldered connections,
- high power cycling capability ($\geq 50\ 000$).

The thyristor/diode chips have been optimized with regard to their turn-off parameters: decreasing the carrier lifetime results in reduced stored charges QS, which in turn significantly reduces requirements for RC-snubbers for over-voltage protection. Cost reduction and improved efficiency are the benefits of these characteristics. By re-developing the silicon chips, improvements of the firing characteristics were achieved by specifying a higher „gate current not to fire“ IGD resulting in substantially less susceptibility to misfiring. This leads to greater safety of operation and higher reliability of the equipment.

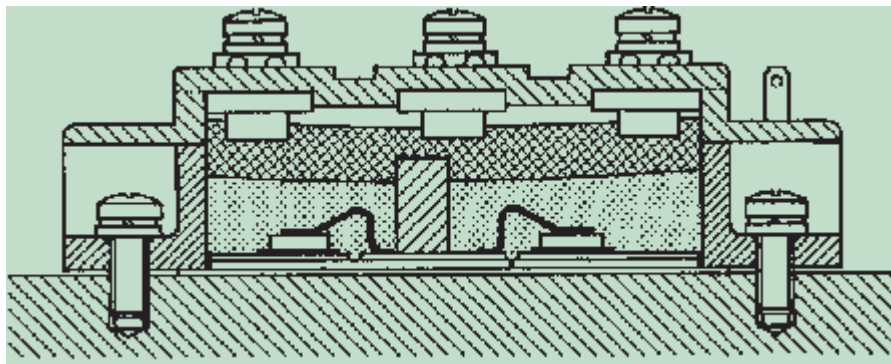
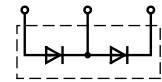

Fig. 1: Principal cross section of an IXYS module with DCB technology

Diode Modules, Dual



MDD...
MDM/NA...P...

$$I_{FAV} = 25 - 99 \text{ A}$$

Type	V_{RRM} V	I_{FAV} A	T_C °C	I_{FSM} 45°C 10 ms A	V_{FO} V	r_F mΩ	T_{VJM} °C	R_{thJC} K/W	R_{thCH} K/W	Fig. No.	Package style Outline drawings on pages O-36...O-59
MDMA 25P1200TG MDMA 25P1600TG MDMA 25P1800TG MDNA 25P2200TG	1200 1600 1800 2200	25	100	320	0.85	11.10	150	1.10	0.20	X125e	
MDD 26-08N1B MDD 26-12N1B MDD 26-14N1B MDD 26-16N1B MDD 26-18N1B	800 1200 1400 1600 1800	36	100	650	0.80	6.10	150	1.00	0.20		
MDMA 35P1200TG MDMA 35P1600TG MDMA 35P1800TG MDNA 35P2200TG	1200 1600 1800 2200	35	100	500	0.83	7.30	150	0.90	0.20		
MDD 44-08N1B MDD 44-12N1B MDD 44-14N1B MDD 44-16N1B MDD 44-18N1B	800 1200 1400 1600 1800	59	100	1150	0.80	4.30	150	0.59	0.20		
MDMA 50P1200TG MDMA 50P1600TG MDMA 50P1800TG MDNA 50P2200TG	1200 1600 1800 2200	50	100	850	0.85	5.70	150	0.65	0.20		
MDD 56-08N1B MDD 56-12N1B MDD 56-14N1B MDD 56-16N1B MDD 56-18N1B	800 1200 1400 1600 1800	71	100	1400	0.80	3.00	150	0.51	0.20		
MDMA 65P1200TG MDMA 65P1600TG MDMA 65P1800TG MDNA 65P2200TG	1200 1600 1800 2200	65	100	1100	0.81	4.30	150	0.50	0.20		
MDD 72-08N1B MDD 72-12N1B MDD 72-14N1B MDD 72-16N1B MDD 72-18N1B	800 1200 1400 1600 1800	99	100	1700	0.80	2.30	150	0.35	0.20		
MDMA 85P1200TG MDMA 85P1600TG MDMA 85P1800TG MDNA 85P2200TG	1200 1600 1800 2200	85	100	1500	0.79	3.50	150	0.35	0.20		

X125e

TO-240AA

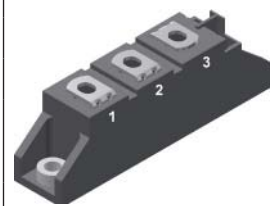

Diode Modules, Dual

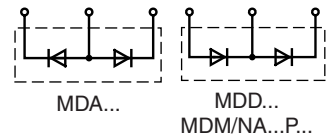





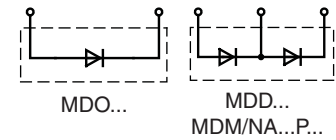

$I_{FAV} = 110 - 240 \text{ A}$

Type	V_{RRM}	I_{FAV}	T_C	I_{FSM} 45°C 10 ms	V_{F0}	r_F	T_{VJM}	R_{thJC}	R_{thCH}	Fig. No.	Package style Outline drawings on pages O-36...O-59
➤ New	V	A	°C	A	V	mΩ	°C	K/W	K/W		
MDD 95-08N1B	800	120	100	2800	0.75	1.95	150	0.26	0.20	X125e	X125e TO-240AA 
MDD 95-12N1B	1200										
MDD 95-14N1B	1400										
MDD 95-16N1B	1600										
MDD 95-18N1B	1800										
MDD 95-20N1B	2000										
MDD 95-22N1B	2200										
MDA 95-22N1B	2200										
MDMA 110P1200TG	1200	110	100	2000	0.82	2.80	150	0.30	0.20	X126c	X126c Y4 
MDMA 110P1600TG	1600										
MDMA 110P1800TG	1800										
MDNA 110P2200TG	2200										
MDMA 140P1200TG	1200	140	100	2800	0.78	2.20	150	0.23	0.20	X126c	X126c Y4 
MDMA 140P1600TG	1600										
MDMA 140P1800TG	1800										
MDNA 140P2200TG	2200										
MDD 142-08N1	800	165	100	4700	0.80	1.30	150	0.21	0.10	X126c	X131c Y1 
MDD 142-12N1	1200										
MDD 142-14N1	1400										
MDD 142-16N1	1600										
MDD 142-18N1	1800										
➤ MDMA 180P1600YD	1600	180	100	4400	0.77	1.40	150	0.20	0.11	X141c	X141c SimBus A 
➤ MDNA 180P2200YD	2200										
MDD 172-08N1	800	190	100	6600	0.80	0.80	150	0.21	0.10	X141c	X141c SimBus A 
MDD 172-12N1	1200										
MDD 172-14N1	1400										
MDD 172-16N1	1600										
MDD 172-18N1	1800										
MDMA 210P1600YD	1600	210	100	6600	0.67	1.20	150	0.17	0.09	X141c	X141c SimBus A 
➤ MDNA 210P2200YD	2200										
MDD 200-14N1	1400	224	100	10500	0.80	0.60	150	0.13	0.10	X131c	X131c Y1 
MDD 200-16N1	1600										
MDD 200-18N1	1800										
MDD 200-22N1	2200										
MDD 175-28N1	2800	240	100	8500	0.74	1.27	150	0.14	0.04	X131c	X131c Y1 
MDD 175-34N1	3400										
MDMA 200P1600SA	1600	200	110	6000	0.76	1.40	150	0.15	0.08	X141c	X141c SimBus A 

Diode Modules, Single and Dual

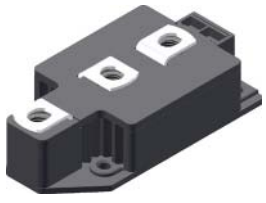
$$I_{FAV} = 270 - 700 \text{ A}$$

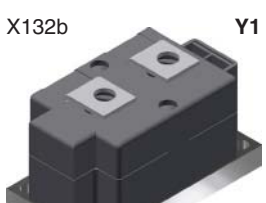

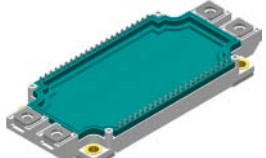
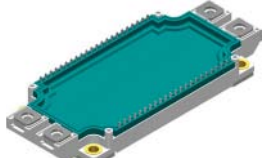
Type	V _{RRM}	I _{FAV}	T _C	I _{FSM} 45°C 10 ms	V _{F0}	r _F	T _{VJM}	R _{thJC}	R _{thCH}	Fig. No.	Package style
➤ New	V	A	°C	A	V	mΩ	°C	K/W	K/W		Outline drawings on pages O-36...O-59
MDD 255-12N1	1200	270	100	9500	0.80	0.60	150	0.140	0.04	X131c	X126c Y4 
MDD 255-14N1	1400										
MDD 255-16N1	1600										
MDD 255-18N1	1800										
MDD 255-20N1	2000										
MDD 255-22N1	2200										
MDMA 280P1600YD	1600	280	100	10500	0.74	1.00	150	0.130	0.06	X126c	X129c Y2 
➤ MDNA 280P2200YD	2200										
➤ MDMA 300P1600PTSF	1600	300	100	8000	0.78	1.30	150	0.100	0.05	X143a	X129c Y1 
MDNA 300P2200PTSF	2200										
MDD 310-12N1	1200	305	100	11500	0.75	0.63	150	0.129	0.04	X129c	
MDD 310-14N1	1400										
MDD 310-16N1	1600										
MDD 310-18N1	1800										
MDD 310-20N1	2000										
MDD 310-22N1	2200										
MDD 312-12N1	1200	310	100	10500	0.80	0.60	150	0.120	0.04	X131c	X131c Y1 
MDD 312-14N1	1400										
MDD 312-16N1	1600										
MDD 312-18N1	1800										
MDD 312-20N1	2000										
MDD 312-22N1	2200										
MDMA 380P1600KC	1600	380	100	11000	0.75	0.53	150	0.110	0.04		X132b Y1 
MDMA 380P1800KC	1800										
MDNA 380P2200KC	2200										
MDMA 425P1600PTSF	1600	425	100	10000	0.77	1.01	150	0.070	0.04	X143a	X142c ComPack 
MDNA 425P2200PTSF	2200										
MDO 500-12N1	1200	560	85	15000	0.80	0.38	140	0.072	0.02	X132b	
MDO 500-14N1	1400										
MDO 500-16N1	1600										
MDO 500-18N1	1800										
MDO 500-20N1	2000										
MDO 500-22N1	2200										
MDO 600-16N1	1600	608	85	15000	0.76	0.32	140	0.072	0.02		
MDMA 600P1600PTSF	1600	600	100	15000	0.78	0.67	150	0.050	0.03	X143a	X143a SimBus F PFP 
MDNA 600P2200PTSF	2200										
MDMA 700P1600CC	1600	700	100	20000	0.78	0.35	150	0.055	0.02	X142c	X142c SimBus F PFP 
MDMA 700P1800CC	1800										
MDNA 700P2200CC	2200										

For more single and dual diode modules with higher current, please see pages 177 - 179

See data sheet for pin arrangement

Thyristor / Diode Modules

$I_{TAV} = 25 - 80 \text{ A}$

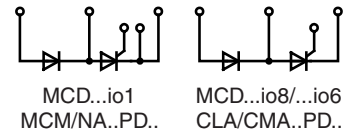

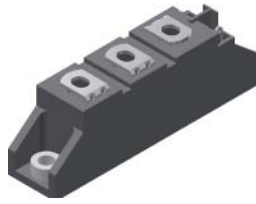





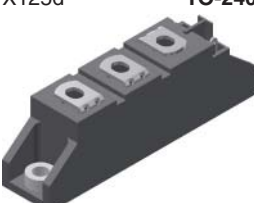
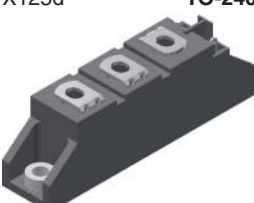

Type	V_{RRM} V_{DRM} V	I_{TAV} A	T_C °C	$I_{T(RMS)}$ A	I_{TSM} 45°C 10 ms A	V_{T0} V	r_T mΩ	T_{VJM} °C	R_{thJC} K/W	R_{thCH} K/W	Fig. No.	Package style Outline drawings on pages O-36...O-59		
MCMA 25PD1200TB MCMA 25PD1600TB	1200 1600	25	82	40	400	0.87	13.0	140	1.20	0.20	X125b	 <p>TO-240AA</p>		
MCD 26-08io1B MCD 26-12io1B MCD 26-14io1B MCD 26-16io1B	800 1200 1400 1600	27	85	50	520	0.85	11.0	125	0.88	0.20				
MCD 26-08io8B MCD 26-12io8B MCD 26-14io8B MCD 26-16io8B	800 1200 1400 1600	27	85	50	520	0.85	11.0	125	0.88	0.20			X125d	 <p>TO-240</p>
MCMA 35PD1200TB MCMA 35PD1600TB	1200 1600	35	85	55	520	0.87	9.8	140	0.90	0.20			X125b	
MCD 40-12io6 MCD 40-16io6	1200 1600	40	85	63	500	0.87	10.5	150	0.70	0.10			X027a	
MCD 44-08io1B MCD 44-12io1B MCD 44-14io1B MCD 44-16io1B MCD 44-18io1B	800 1200 1400 1200 1600	49	85	77	1150	0.85	5.3	125	0.53	0.20	X125b			
MCD 44-08io8B MCD 44-12io8B MCD 44-14io8B MCD 44-16io8B MCD 44-18io8B	800 1200 1400 1600 1800	49	85	77	1150	0.85	5.3	125	0.53	0.20	X125d			
MCNA 40PD2200TB MCMA 50PD1200TB MCMA 50PD1600TB	2200 1200 1600	40	85	63	500	0.84	11.4	140	0.70	0.20	X125b			
CLA 60PD1200NA	1200	60	100	94	1100	0.79	4.8	150	0.55	0.10			X027a	
MCD 56-08io1B MCD 56-12io1B MCD 56-14io1B MCD 56-16io1B MCD 56-18io1B	800 1200 1400 1600 1800	60	85	100	1500	0.85	3.7	125	0.45	0.20	X125b	 <p>SOT-227B miniBLOC</p>		
MCD 56-08io8B MCD 56-12io8B MCD 56-14io8B MCD 56-16io8B MCD 56-18io8B	800 1200 1400 1600 1800	60	85	100	1500	0.85	3.7	125	0.45	0.20	X125d			
MCNA 55PD2200TB MCMA 65PD1200TB MCMA 65PD1600TB MCMA 65PD1800TB	2200 1200 1600 1800	55	85	86	800	0.90	9.0	150	0.50	0.20	X125b			
CMA 80PD1600NA	1600	80	80	126	1070	0.86	5.5	150	0.45	0.10			X027a	

Thyristor / Diode Modules

$$I_{TAV} = 75 - 165 \text{ A}$$



Type	V_{RRM} V_{DRM} V	I_{TAV} A	T_C °C	$I_{T(RMS)}$ A	I_{TSM} 45°C 10 ms A	V_{TO} V	r_T mΩ	T_{VJM} °C	R_{thJC} K/W	R_{thCH} K/W	Fig. No.	Package style Outline drawings on pages O-36...O-59	
MCD 72-08io1B	800	85	85	180	1700	0.85	3.2	125	0.30	0.20	X125b	X125b TO-240AA 	
MCD 72-12io1B	1200												
MCD 72-14io1B	1400												
MCD 72-16io1B	1600												
MCD 72-18io1B	1800												
MCD 72-08io8B	800	85	85	180	1700	0.85	3.2	125	0.30	0.20	X125d		
MCD 72-12io8B	1200												
MCD 72-14io8B	1400												
MCD 72-16io8B	1600												
MCD 72-18io8B	1800												
MCNA 75PD2200TB	2200	75	85	118	1050	0.90	6.5	140	0.38	0.20	X125b	X125d TO-240 	
MCMA 85PD1200TB	1200	85	85	135	1500	0.85	3.9	140	0.38	0.20			
MCMA 85PD1600TB	1600												
MCMA 85PD1800TB	1800												
CLA 100PD1200NA	1200	100	85	150	1500	0.83	3.7	150	0.35	0.10	X027a		
MCD 94-20io1B	2000	104	85	180	1700	0.85	3.2	125	0.22	0.20	X125b		
MCD 94-22io1B	2200												
MCD 95-08io1B	800	116	85	180	2250	0.85	2.4	125	0.22	0.20			
MCD 95-12io1B	1200												
MCD 95-14io1B	1400												
MCD 95-16io1B	1600												
MCD 95-18io1B	1800												
MCD 95-16io1	1600										X125y		
MCD 95-08io8B	800	116	85	180	2250	0.85	2.4	125	0.22	0.20	X125d		
MCD 95-12io8B	1200												
MCD 95-14io8B	1400												
MCD 95-16io8B	1600												
MCD 95-18io8B	1800												
MCNA 95PD2200TB	2200	95	85	149	1400	0.90	5.0	140	0.30	0.20	X125b	X126b Y4 	
MCMA 110PD1200TB	1200	110	85	170	1900	0.85	3.3	140	0.30	0.20			
MCMA 110PD1600TB	1600												
MCMA 110PD1800TB	1800												
MCNA 120PD2200TB	2200	120	85	190	1700	0.90	3.7	140	0.22	0.20			
MCNA 120PD2200TB-NI											X125y		
MCMA 140PD1200TB	1200	140	85	200	2400	0.85	2.8	140	0.22	0.20	X125b	X027a SOT-227B miniBLOC 	
MCMA 140PD1600TB	1600												
MCMA 140PD1800TB	1800												
MCMA 140PD1600TB-NI	1600										X125y		
MCD 132-08io1	800	130	85	300	4750	0.80	1.5	125	0.23	0.10	X126b		
MCD 132-12io1	1200												
MCD 132-14io1	1400												
MCD 132-16io1	1600												
MCD 132-18io1	1800												

Thyristor / Diode Modules

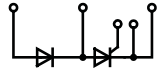

MCD...io1
MCM/NA..PD..

$I_{TAV} = 180 - 700 \text{ A}$

Type	V_{RRM} V_{DRM}	I_{TAV}	T_C	$I_{T(RMS)}$	I_{TSM} 45°C 10 ms	V_{TO}	r_T	T_{VJM}	R_{thJC}	R_{thCH}	Fig. No.	Package style
➤ New	V	A	°C	A	A	V	mΩ	°C	K/W	K/W		Outline drawings on pages O-36...O-59
MCNA 150PD2200YB	2200	150	85	235	4300	0.86	2.10	140	0.210	0.11	X126b	 Y4
MCD 161-20io1	2000	165	85	300	6000	0.80	1.60	125	0.155	0.07		
MCD 161-22io1	2200											
MCD 162-08io1	800	181	85	300	6000	0.88	1.15	125	0.155	0.07		
MCD 162-12io1	1200											
MCD 162-14io1	1400											
MCD 162-16io1	1600											
MCD 162-18io1	1800											
MCNA 180PD2200YB	2200	180	85	280	5400	0.85	1.80	140	0.170	0.09		
MCMA 200PD1600SA	1600	200	85	314	6000	0.81	1.60	140	0.150	0.08	X141b	X129b Y2
MCD 200-14io1	1400	216	85	340	8000	0.80	1.40	125	0.130	0.05	X126b	
MCD 200-16io1	1600											
MCD 200-18io1	1800											
MCNA 220PD2200YB	2200	220	85	345	7200	0.84	1.50	140	0.130	0.07		
MCD 224-20io1	2000	240	85	400	8000	0.80	0.76	130	0.139	0.04	X131b	
MCD 224-22io1	2200											
MCD 225-12io1	1200	221	85	400	8000	0.80	0.76	130	0.157	0.04	X131b	 Y1
MCD 225-14io1	1400											
MCD 225-16io1	1600											
MCD 225-18io1	1800											
➤ MCNA 250PD2200PTSF	2200	250	85	400	5900	0.76	2.20	150	0.100	0.05	X143a	
MCD 255-12io1	1200	250	85	450	9000	0.80	0.68	130	0.140	0.04	X131b	
MCD 255-14io1	1400											
MCD 255-16io1	1600											
MCD 255-18io1	1800											
MCMA 260PD1600YB	1600	260	85	408	8300	0.81	1.23	140	0.130	0.08	X126b	X141b SimBus A
MCMA 260PD1800YB	1800											
MCMA 265PD1600KB	1600	260	85	408	8500	0.80	0.75	140	0.160	0.04	X131b	
MCMA 265PD1800KB	1800											
➤ MCMA 280PD1600PTSF	1600	280	85	440	7000	0.83	1.57	150	0.100	0.05	X143a	
MCD 310-08io1	800	320	85	500	9200	0.80	0.82	140	0.112	0.04	X129b	
MCD 310-12io1	1200											
MCD 310-14io1	1400											
MCD 310-16io1	1600											
MCD 310-18io1	1800											
MCD 310-20io1	2000	320	85	500	8000	0.80	0.82	140	0.112	0.04		
MCD 310-22io1	2200											
MCD 312-12io1	1200	320	85	520	9200	0.80	0.68	140	0.120	0.04	X131b	
MCD 312-14io1	1400											
MCD 312-16io1	1600											
MCD 312-18io1	1800											
➤ MCNA 360PD2200PTSF	2200	360	85	570	8400	0.74	1.57	150	0.070	0.04	X143a	X143a SimBus F PFP
MCMA 400PD1600PTSF	1600	400	85	630	10000	0.82	1.14	150	0.070	0.04		
➤ MCNA 500PD2200PTSF	2200	500	85	790	11000	0.75	1.11	150	0.050	0.03		
MCMA 550PD1600PTSF	1600	550	85	864	13000	0.82	0.80	150	0.050	0.03		
MCNA 650PD2200CB	2200	650	85	1020	16000	0.75	0.63	140	0.045	0.02	X142b	
MCMA 700PD1600CB	1600	700	85	1100	19000	0.82	0.40	140	0.050	0.02		
MCMA 700PD1800CB	1800											

For more thyristor / diode modules with higher current, please see pages 175, 176 and 179

See data sheet for pin arrangement

Thyristor Modules, Dual

$I_{TAV} = 18 - 60 \text{ A}$



Type	V_{RRM} V_{DRM} V	I_{TAV} A	T_C °C	$I_{T(RMS)}$ A	I_{TSM} 45°C 10 ms A	V_{TO} V	r_T mΩ	T_{VJM} °C	R_{thJC} K/W	R_{thCH} K/W	Fig. No.	Package style Outline drawings on pages O-36...O-59	
MCC 19-08io1B MCC 19-12io1B MCC 19-14io1B MCC 19-16io1B	800 1200 1400 1600	18	85	40	400	0.85	18.0	125	1.30	0.2	X125a	 <p>TO-240AA</p>	
MCC 19-08io8B MCC 19-12io8B MCC 19-14io8B MCC 19-16io8B	800 1200 1400 1600	18	85	40	400	0.85	18.0	125	1.30	0.2	X125c		
MCC 21-08io8B MCC 21-12io8B MCC 21-14io8B MCC 21-16io8B	800 1200 1400 1600	21	85	33	320	0.85	15.0	125	1.10	0.2			
MCMA 25P1200TA MCMA 25P1600TA	1200 1600	25	85	40	400	0.87	13.0	140	1.20	0.2	X125a		
MCC 26-08io1B MCC 26-12io1B MCC 26-14io1B MCC 26-16io1B	800 1200 1400 1600	27	85	50	520	0.85	11.0	125	0.88	0.2			
MCC 26-14io1	1400										X125z		
MCC 26-08io8B MCC 26-12io8B MCC 26-14io8B MCC 26-16io8B	800 1200 1400 1600	27	85	50	520	0.85	11.0	125	0.88	0.2	X125c		 <p>TO-240</p>
MCMA 35P1200TA MCMA 35P1600TA	1200 1600	35	85	55	520	0.87	9.8	140	0.90	0.2	X125a		
MCC 44-08io1B MCC 44-12io1B MCC 44-14io1B MCC 44-16io1B MCC 44-18io1B	800 1200 1400 1600 1800	49	85	77	1150	0.85	5.3	125	0.53	0.2			
MCC 44-08io8B MCC 44-12io8B MCC 44-14io8B MCC 44-16io8B MCC 44-18io8B	800 1200 1400 1600 1800										X125c		
MCNA 40P2200TA MCMA 50P1200TA MCMA 50P1600TA	2200 1200 1600	40 50	85	63 79	500 800	0.84 0.89	11.4 5.3	140	0.70	0.2	X125a		
MCC 56-08io1B MCC 56-12io1B MCC 56-14io1B MCC 56-16io1B MCC 56-18io1B	800 1200 1400 1600 1800	60	85	100	1500	0.85	3.7	125	0.45	0.2			
MCC 56-08io8B MCC 56-12io8B MCC 56-14io8B MCC 56-16io8B MCC 56-18io8B	800 1200 1400 1600 1800										X125z		
MCC 56-14io1	1400										X125z		
MCC 56-08io8B MCC 56-12io8B MCC 56-14io8B MCC 56-16io8B MCC 56-18io8B	800 1200 1400 1600 1800	60	85	100	1500	0.85	3.7	125	0.45	0.2	X125c	 <p>TO-240</p>	

Thyristor Modules, Dual

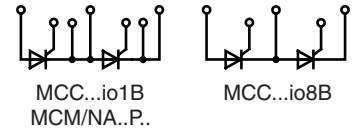







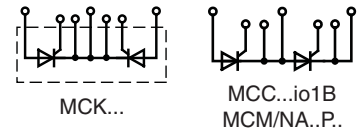

$$I_{TAV} = 55 - 140 \text{ A}$$

Type	V_{RRM} V_{DRM} V	I_{TAV} A	T_C °C	$I_{T(RMS)}$ A	I_{TSM} 45°C 10 ms A	V_{TO} V	r_T mΩ	T_{VJM} °C	R_{thJC} K/W	R_{thCH} K/W	Fig. No.	Package style Outline drawings on pages O-36...O-59
MCNA 55P2200TA	2200	55	85	86	800	0.90	9.0	140	0.50	0.2	X125a	 <p>V1-A-Pack</p>
MCMA 65P1200TA	1200	65	85	105	1150	0.85	4.8	140	0.50	0.2		
MCMA 65P1600TA	1600											
MCMA 65P1800TA	1800											
MCC 72-08io1B	800	85	85	180	1700	0.85	3.2	125	0.30	0.2	X125c	 <p>TO-240AA</p>
MCC 72-12io1B	1200											
MCC 72-14io1B	1400											
MCC 72-16io1B	1600											
MCC 72-18io1B	1800											
MCC 72-08io8B	800	85	85	180	1700	0.85	3.2	125	0.30	0.2	X125a	 <p>TO-240</p>
MCC 72-12io8B	1200											
MCC 72-14io8B	1400											
MCC 72-16io8B	1600											
MCC 72-18io8B	1800											
MCNA 75P2200TA	2200	75	85	118	1050	0.90	6.5	140	0.38	0.2	X125a	 <p>TO-240</p>
MCMA 85P1200TA	1200	85	85	135	1500	0.85	3.9	140	0.38	0.2		
MCMA 85P1600TA	1600											
MCMA 85P1800TA	1800											
MCC 94-20io1B	2000	104	85	180	1700	0.85	3.2	125	0.22	0.2	X125c	 <p>TO-240</p>
MCC 94-22io1B	2200											
MCC 94-24io1B	2400											
MCC 95-08io1B	800	116	85	180	2250	0.83	2.4	125	0.22	0.2	X125z	 <p>TO-240</p>
MCC 95-12io1B	1200											
MCC 95-14io1B	1400											
MCC 95-16io1B	1600											
MCC 95-18io1B	1800											
MCC 95-14io1	1400										X125z	<p>TO-240</p>
MCC 95-16io1	1600											
MCC 95-08io8B	800	116	85	180	2250	0.85	2.4	125	0.22	0.2	X125c	<p>TO-240</p>
MCC 95-12io8B	1200											
MCC 95-14io8B	1400											
MCC 95-16io8B	1600											
MCC 95-18io8B	1800											
MCNA 95P2200TA	2200	95	85	149	1400	0.90	5.0	140	0.30	0.2	X125a	<p>TO-240</p>
MCMA 110P1200TA	1200	110	85	170	1900	0.85	3.3	140	0.30	0.2		
MCMA 110P1600TA	1600											
MCMA 110P1800TA	1800											
MCMA 110P1600VA	1600										X103	
MCNA 120P2200TA	2200	120	85	190	1700	0.90	3.7	140	0.22	0.2	X125a	<p>Y4</p>
MCMA 140P1200TA	1200	140	85	220	2400	0.85	2.8	140	0.22	0.2		
MCMA 140P1400TA	1400											
MCMA 140P1600TA	1600											
MCMA 140P1800TA	1800											
MCC 132-08io1	800	130	85	300	4750	0.80	1.5	125	0.23	0.1	X126a	
MCC 132-12io1	1200											
MCC 132-14io1	1400											
MCC 132-16io1	1600											
MCC 132-18io1	1800											

Thyristor Modules, Dual

$I_{TAV} = 150 - 700 \text{ A}$

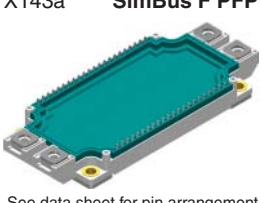
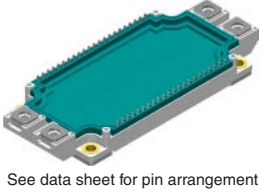
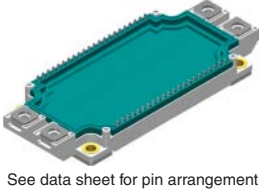

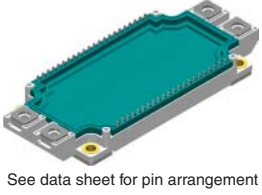
Type	V_{RRM} V_{DRM}	I_{TAV}	T_C	$I_{T(RMS)}$	I_{TSM} 45°C 10 ms	V_{T0}	r_T	T_{VJM}	R_{thJC}	R_{thCH}	Fig. No.	Package style Outline drawings on pages O-36...O-59
➤ New	V	A	°C	A	A	V	mΩ	°C	K/W	K/W		
MCNA 150P2200YA	2200	150	85	235	4300	0.86	2.10	140	0.210	0.11	X126a	X126a Y4 
➤ MCMA 160P1600YA	1600	160	85	250	4750	0.82	1.63	140	0.210	0.11	X126a	
➤ MCMA 160P1800YA-MI	1800										X126z	
MCC 161-20io1	2000	165	85	300	6000	0.80	1.60	125	0.155	0.07	X126a	X129a Y2 
MCC 161-22io1	2200										X126a	
MCC 162-08io1	800	181	85	300	6000	0.88	1.15	125	0.155	0.07	X126a	
MCC 162-12io1	1200										X126a	
MCC 162-14io1	1400										X126a	
MCC 162-16io1	1600										X126a	
MCC 162-18io1	1800										X126a	
MCNA 180P2200YA	2200	180	85	280	5400	0.85	1.80	140	0.170	0.09	X126a	X131a Y1 
MCMA 200P1600SA	1600	200	90	314	6000	0.81	1.60	140	0.150	0.08	X141a	
➤ MCMA 200P1600YA	1600	200	85	315	6000	0.83	1.43	140	0.170	0.09	X126a	
➤ MCMA 200P1800YA-MI	1800										X126z	
MCC 200-14io1	1400	216	85	340	8000	0.80	1.40	125	0.130	0.05	X126a	X131a Y1 
MCC 200-16io1	1600										X126a	
MCC 200-18io1	1800										X126a	
MCK 200-18io1	1800	216	85	340	8000	0.80	1.40	125	0.130	0.05	X126a	X141a SimBus A 
MCNA 220P2200YA	2200	220	85	345	7200	0.84	1.50	140	0.130	0.07	X126a	
MCC 224-20io1	2000	240	85	400	8000	0.80	0.76	130	0.139	0.04	X131a	
MCC 224-22io1	2200										X131a	X141a SimBus A 
MCC 224-24io1	2400										X131a	
MCC 225-12io1	1200	221	85	400	8000	0.80	0.76	130	0.157	0.04	X131a	
MCC 225-14io1	1400										X131a	X142a ComPack 
MCC 225-16io1	1600										X131a	
MCC 225-18io1	1800										X131a	
➤ MCNA 250P2200PTSF	2200	250	85	400	5900	0.76	2.20	150	0.100	0.05	X143a	X143a SimBus F PFP 
MCC 255-12io1	1200	250	85	450	9000	0.80	0.68	130	0.140	0.04	X131a	
MCC 255-14io1	1400										X131a	
MCC 255-16io1	1600										X131a	
MCC 255-18io1	1800										X131a	
MCMA 260P1600YA	1600	260	85	408	8300	0.81	1.23	140	0.130	0.08	X126a	X142a ComPack 
MCMA 260P1800YA	1800										X126a	
MCMA 265P1600KA	1600	260	85	408	8500	0.80	0.75	140	0.160	0.04	X131a	
MCMA 265P1800KA	1800										X131a	X143a SimBus F PFP 
➤ MCMA 280P1600PTSF	1600	280	85	440	7000	0.83	1.57	150	0.100	0.05	X143a	
MCC 310-08io1	800	320	85	500	9200	0.80	0.82	140	0.112	0.04	X129a	
MCC 310-12io1	1200										X129a	X142a ComPack 
MCC 310-14io1	1400										X129a	
MCC 310-16io1	1600										X129a	
MCC 310-18io1	1800										X129a	
MCC 312-12io1	1200	320	85	520	9200	0.80	0.68	140	0.120	0.04	X131a	X142a ComPack 
MCC 312-14io1	1400										X131a	
MCC 312-16io1	1600										X131a	
MCC 312-18io1	1800										X131a	
➤ MCNA 360P2200PTSF	2200	360	85	570	8400	0.74	1.57	150	0.070	0.04	X143a	X143a SimBus F PFP 
➤ MCMA 400P1600PTSF	1600	400	85	630	10000	0.82	1.14	150	0.070	0.04	X143a	
➤ MCNA 500P2200PTSF	2200	500	85	790	11000	0.75	1.11	150	0.050	0.03	X143a	
➤ MCMA 550P1600PTSF	1600	550	85	860	13000	0.82	0.80	150	0.050	0.03	X143a	
MCNA 650P2200CA	2200	650	85	1020	16000	0.75	0.63	140	0.045	0.02	X142a	X142a ComPack 
MCMA 700P1600CA	1600	700	85	1100	19000	0.82	0.40	140	0.050	0.02	X142a	
MCMA 700P1800CA	1800										X142a	
MCMA 700P1600NCA	1600	700	85	1100	19000	0.82	0.40	140	0.050	0.02	X142a	
MCMA 700P1800NCA	1800										X142a	

For more dual thyristor modules with higher current, please see pages 173 and 179

See data sheet for pin arrangement

Thyristor Modules, Single

$I_{TAV} = 32 - 600 \text{ A}$

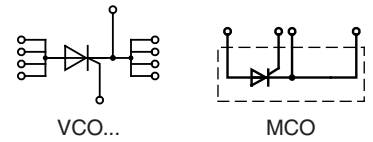

Type	V_{RRM} V_{DRM} V	I_{TAV} A	T_C °C	$I_{T(RMS)}$ A	I_{TSM} 45°C 10 ms A	V_{T0} V	r_T mΩ	T_{VJM} °C	R_{thJC} K/W	R_{thCH} K/W	Fig. No.	Package style Outline drawings on pages O-36...O-59				
MCO 25-12io1 MCO 25-16io1	1200 1600	32	80	50	370	0.86	13.90	150	1.100	0.30	X027a					
MCO 50-12io1 MCO 50-16io1	1200 1600	57	80	90	740	0.88	6.00	150	0.720	0.20						
MCO 75-12io1 MCO 75-16io1	1200 1600	80	80	125	1070	0.85	5.50	150	0.450	0.10						
MCO 100-12io1 MCO 100-16io1	1200 1600	101	80	160	1400	0.85	4.50	150	0.350	0.10						
MCO 150-12io1 MCO 150-16io1	1200 1600	158	80	250	2000	0.84	3.50	150	0.200	0.10						
MCO 450-20io1 MCO 450-22io1	2000 2200	464	85	750	15000	0.77	0.42	130	0.072	0.02			X132a			
MCO 500-12io1 MCO 500-14io1 MCO 500-16io1 MCO 500-18io1	1200 1400 1600 1800	560	85	880	17000	0.80	0.38	140	0.072	0.02						
MCO 600-16io1 MCO 600-18io1 MCO 600-20io1 MCO 600-22io1	1600 1800 2000 2200	600	85	940	15000	0.81	0.40	140	0.065	0.02						
VCO 132-12io7 VCO 132-16io7	1200 1600	130	85	200	3600	0.80	1.65	150	0.250	0.10					X102	
VCO 180-12io7 VCO 180-16io7	1200 1600	180	90	280	4500	0.75	1.23	150	0.170	0.06						

For more single thyristor modules with higher current, please see page 174

X027a **SOT-227B miniBLOC**



X132a **Y1**



X102 **ECO-PAC 2**

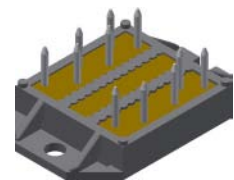

See data sheet for pin arrangement

Optional Accessories for Thyristor / Diode Modules



For module types MCC/MCD/MCO/MCMA/MCNA 132, 161 up to 700 (for MCD/MCO only L-type):
Keyed Gate Cathode twin plugs with wire length = 350 / 480 mm
gate = white, cathode = red

Type **ZY 180 L** (L = Left for pin pair 4/5)
Type **ZY 180 R** (R = Right for pin pair 6/7)

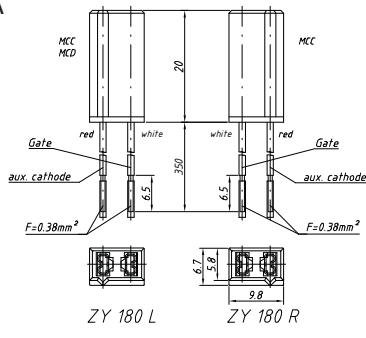



For module-type TO-240 package MCC/MCD/MCMA/MCNA 19 up to 120 and 140 (version 1):
Keyed Gate Cathode twin plugs with wire length = 340 / 460 mm;
gate = white, cathode = red

Type **ZY 200 L** (L = Left for pin pair 4/5)
Type **ZY 200 R** (R = Right for pin pair 6/7)

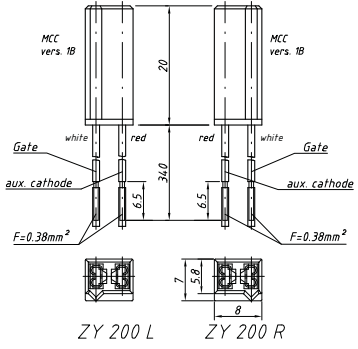



For ZY 180 and ZY 200: UL 758 Style 3751

For module types MCC/MCD/MDD 310
Threaded spacer for higher Anode / Cathode construction:

Type **ZY 250** (material brass)

Not for new design

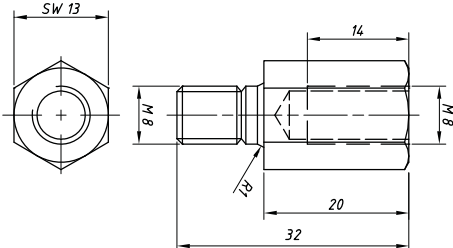

Design Information

For Thyristors, Diodes, Thyristor / Diode Modules and Rectifier Bridges

Surge current	The 60 Hz value of I_{TSM} is 10% higher than the 50 Hz value The I_{TSM} value at T_{VJM} is 10% to 15% lower than the 45°C value
Limiting I^2t	50 Hz: $I^2t [A^2s] = I_{TSM} [A] \cdot I_{TSM} [A] \cdot 0.005 [s]$; use rated I_{TSM} value (10 ms) 60 Hz: $I^2t [A^2s] = I_{TSM} [A] \cdot I_{TSM} [A] \cdot 0.0042 [s]$; use 60-Hz-value of I_{TSM}
Forward current	The average current ratings in tables are mostly specified for temperature conditions of: $T_A = 45^\circ C$, $T_C = 85^\circ C$ or $T_C = 100^\circ C$. For other temperature conditions the current ratings can be calculated using the following formulas applicable up to 400 Hz.
$I_{TAV} = \frac{-V_{T0} + \sqrt{V_{T0}^2 + 4 \cdot k^2 \cdot r_T \cdot P}}{2 \cdot k^2 \cdot r_T} \quad \text{where} \quad P = \frac{T_{VJM} - T_C}{R_{thJC}} \quad \text{or} \quad P = \frac{T_{VJM} - T_A}{R_{thJA}}$	
$I_{TAV} [A], P [W]; V_{T0} [V]; r_T [\Omega], T_{VJM} [^\circ C], T_C [^\circ C], T_A [^\circ C], R_{thJC} [K/W], R_{thJA} [K/W]$	
$k^2 = 1$ for DC current $k^2 = 2.5$ for sinusoidal half wave current $k^2 = 3$ for 120° rectangular current $k^2 = 6$ for 60° rectangular current	
The average forward current is limited by the RMS current value $I_{T(RMS)}$. When the calculated value I_{TAV} is higher than $I_{T(RMS)} / k$, replace it by $I_{TAV} = I_{T(RMS)} / k$.	

104

Data according to IEC 60747 and refer to a single diode or thyristor unless otherwise stated.

Rectifier Bridges with Fast Diodes

1-phase, B2U

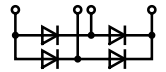

Type	V _{RRM}	I _{dAV}	@ T _C	I _{FSM} 45°C 10 ms	V _{F0}	r _F	T _{VJM}	R _{thJC}	R _{thCH}	Fig. No.	Package style
◇ under development	V	A	°C	A	V	mΩ	°C	K/W	K/W		Outline drawings on pages O-36...O-59
VBE 17-06NO7	600	27	85	50	1.18	22.0	150	2.50	0.30	X101	X024a ISOPLUS i4-PAC™
VBE 17-12NO7	1200	19	85	40	1.32	30.0	150	2.50	0.30		
VBE 26-06NO7	600	44	85	110	1.13	13.0	150	1.60	0.30	X027a	SOT-227B miniBLOC
VBE 26-12NO7	1200	32	85	90	1.32	30.0	150	1.60	0.30		
VBE 55-06NO7	600	68	100	250	0.98	8.0	150	0.90	0.30	X027a	SOT-227B miniBLOC
VBE 55-12NO7	1200	59	85	200	1.31	15.0	150	0.90	0.30		
VBE 60-06A	600	60	100	250	0.98	8.2	150	1.15	0.10	X027a	SOT-227B miniBLOC
VBE 60-12A	1200	60	70	200	1.31	14.0	150	1.15	0.10		
DHG 40B1200LB	1200	34	80	150	1.35	42.0	175	1.50	0.50	X030a	SMPD-B
DPG 60B600LB	600	60	100	250	0.85	17.0	175	1.10	0.40		
FBE 22-06N1	600	22	115	50	1.04	24.0	175	3.00	0.20	X024a	
VBE 100-06NO7	600	100	85	600	1.09	4.3	150	0.80	0.20	X102	X030a
VBE 100-12NO7	1200	100	70	500	1.07	8.2	150	0.80	0.20		
DCG 20B650LB *	650	21	80	250	0.74	118.0	175	2.10	0.70	X030a	ECO-PAC 1
◇ DCG 20B1200LB *	1200	18	80	60	0.68	133.0	175	3.30	0.85		
FBS 10-12SC *	1200	9	80	100	-	-	175	7.00	3.50	X024a	

* SiC-Diodes

3-phase, B6U

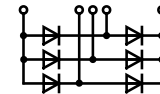

FUS 45-0045B	45	45	130	150	0.30	14.8	150	3.00	0.20	X024a
DHG 60U1200LB	1200	60	80	200	1.35	2.9	150	1.20	0.40	X030a
VUE 50-12NO1	1200	50	85	200	1.65	18.2	150	1.20	0.30	X103
VUE 22-06NO7	600	34	85	50	1.18	22.0	150	2.50	0.30	X101
VUE 22-12NO7	1200	24	85	40	1.39	55.0	150	2.50	0.30	
VUE 35-06NO7	600	56	85	110	1.13	13.0	150	1.60	0.30	X101
VUE 35-12NO7	1200	40	85	90	1.32	30.0	150	1.60	0.30	
VUE 75-06NO7	600	86	100	250	0.98	8.0	150	0.90	0.30	X101
VUE 75-12NO7	1200	74	85	200	1.31	15.0	150	0.90	0.30	
FUE 30-12N1	1200	30	120	90	0.97	48.0	175	2.30	0.20	X024a
VUE 130-06NO7	600	130	85	600	1.09	4.3	150	0.80	0.20	X102
VUE 130-12NO7	1200	130	70	500	1.07	8.2	150	0.80	0.20	

See data sheet for pin arrangement

X102 **ECO-PAC 2**

See data sheet for pin arrangement

X103 **V1-A-Pack**

See data sheet for pin arrangement

Rectifier Bridges incorporating Fast Diodes

Power switching semiconductors are used in inverter systems with DC-Link. Due to high switching frequencies, harmonics and line distortion may be generated. It is important that the new designs reduce these influences and fulfill the EMI filtering requirements according to EMI/EMC VDE 0871 and other.

The noise level can be reduced by up to **10dB** when the input rectifier is equipped with semi-fast diodes and is therefore optimised for turn off; resulting in a lower peak recovery current compared to non-optimised and normal rectifier diodes.

The noise level can be further reduced approximately by another **5dB** when using rectifier bridges equipped with Fast Recovery Epitaxial Diodes (FRED) like module types VBE (single phase bridge) or VUE (three phase bridge). However these are more expensive but may be necessary in some applications to fulfill the VDE or other standards.

This behaviour has a direct influence on the design of the EMI filter networks with its capacitors and inductors of which the size and costs can be reduced.

More detailed information is available in the IXYS application note D98005E „Input Rectifiers with Semi-fast Diodes for DC Link“ on www.ixys.com.

1~ Rectifier Bridges

1~ Rectifier Bridges with Avalanche Diodes, B2U

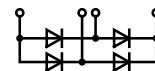

Type	V _{RRM}	V _{VRMS}	I _{dAV}	@ T _C	I _{FSM} 45°C 10 ms	V _{FO}	r _F	T _{VJM}	R _{thJC}	R _{thJH}	P _{RSM}	Fig. No.	Package style
	V	V	A	°C	A	V	mΩ	°C	K/W	K/W	kW		Outline drawings on pages O-36...O-59
VBO 25-12A02 VBO 25-16A02	1200 1600	400 500	38	85	370	0.85	8.0	150	2.80	3.20	3.4	X115	X024a ISOPLUS i4-PAC™
1~ Rectifier Bridges with Standard Diodes, B2U													
FBO 16-12N	1200	400	20	130	150	0.81	32.0	175	3.00	3.20	-	X024a	X025a GBFP
VBO 21-08NO7 VBO 21-12NO7	800 1200	250 400	20	115	120	0.84	28.8	150	2.50	2.90	-	X101	X027a SOT-227B miniBLOC
VBO 22-08NO8 VBO 22-12NO8 VBO 22-16NO8 VBO 22-18NO8	800 1200 1600 1800	250 400 500 575	14	85	380	0.77	14.2	150	8.00	9.00	-	X116b	X025a ECO-PAC 1
GBO 25-12NO1 GBO 25-16NO1	1200 1600	400 500	25	105	370	0.74	16.3	175	4.30	4.80	-	X025a	X115 FO-A
VBO 25-08NO2 VBO 25-12NO2 VBO 25-16NO2	800 1200 1600	250 400 500	38	85	370	0.85	8.0	150	2.80	3.20	-	X115	X116b FO-B
VBO 30-08NO7 VBO 30-12NO7 VBO 30-16NO7 VBO 30-18NO7	800 1200 1600 1800	250 400 500 575	25	85	400	0.80	12.9	150	4.70	4.80	-	X119b	X115 PWS-A
VBO 36-08NO8 VBO 36-12NO8 VBO 36-16NO8 VBO 36-18NO8	800 1200 1600 1800	250 400 500 575	18	85	550	0.76	9.1	150	7.00	8.00	-	X116b	X115 PWS-B
FBO 40-12N	1200	400	40	130	300	0.79	14.0	175	1.50	1.70	-	X024a	X119b PWS-D
VBO 40-08NO6 VBO 40-12NO6 VBO 40-16NO6	800 1200 1600	250 400 500	40	115	320	0.81	12.1	150	1.30	1.40	-	X027a	X120b PWS-B
VBO 50-08NO7 VBO 50-12NO7 VBO 50-16NO7 VBO 50-18NO7	800 1200 1600 1800	250 400 500 575	45	85	750	0.76	6.9	150	2.70	3.10	-	X120b	X122b PWS-D
VBO 52-08NO7 VBO 52-12NO7 VBO 52-16NO7 VBO 52-18NO7	800 1200 1600 1800	250 400 500 575	60	115	550	0.78	8.1	150	1.10	1.50	-	X122b	
VBO 54-08NO7 VBO 54-12NO7 VBO 54-16NO7	800 1200 1600	250 400 500	55	105	300	0.82	12.2	150	1.10	1.50	-	X101	
VBO 68-08NO7 VBO 68-12NO7 VBO 68-16NO7	800 1200 1600	250 400 500	70	105	550	0.81	7.8	150	0.90	1.30	-	X101	
VBO 72-08NO7 VBO 72-12NO7 VBO 72-16NO7 VBO 72-18NO7	800 1200 1600 1800	250 400 500 575	70	110	750	0.78	6.0	150	0.90	1.30	-	X122b	

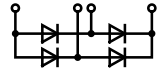

1~ Rectifier Bridges

1~ Rectifier Bridges with Standard Diodes, B2U

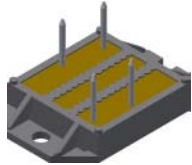
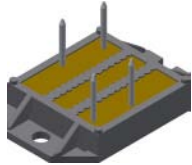
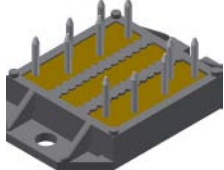
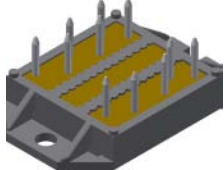
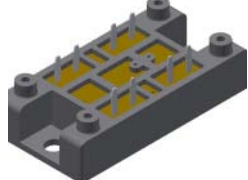

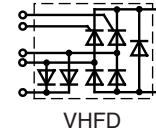
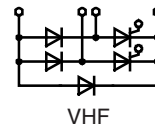
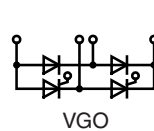
Type	V_{RRM}	V_{VRMS}	I_{dAV}	@ T_C	I_{FSM}	V_{F0}	r_F	T_{VJM}	R_{thJC}	R_{thJH}	Fig. No.	Package style
	V	V	A	°C	45°C 10 ms A	V	mΩ	°C	K/W	K/W		Outline drawings on pages O-36...O-59
VBO 78-08NO7	800	250	80	115	750	0.81	5.9	150	0.70	1.00	X102	X030a SMPD-B 
VBO 78-12NO7	1200	400										
VBO 78-16NO7	1600	500										
VBO 88-08NO7	800	250	90	115	1000	0.80	4.6	150	0.60	0.90	X030a	X101 ECO-PAC 1 
VBO 88-12NO7	1200	400										
VBO 88-16NO7	1600	500										
DLA 100B800LB	800	400	124	80	400	0.75	4.2	175	1.00	1.45	X030a	X101 ECO-PAC 1 
DLA 100B1200LB	1200											
DMA 120B800LB	800	250	130	90	500	0.88	6.4	175	0.80	1.30		
VBO 105-08NO7	800	250	100	100	1500	0.78	4.8	150	0.80	1.10	X121b	See data sheet for pin arrangement
VBO 105-12NO7	1200	400										
VBO 105-16NO7	1600	500										
VBO 125-08NO7	800	250	125	105	1800	0.76	3.6	150	0.60	0.90	X102	X102 ECO-PAC 2 
VBO 125-12NO7	1200	400										
VBO 125-16NO7	1600	500										
VBO 130-08NO7	800	250	130	110	1800	0.77	3.4	150	0.50	0.70	X123e	X123e 
VBO 130-12NO7	1200	400										
VBO 130-16NO7	1600	500										
VBO 130-18NO7	1800	575										
VBO 160-08NO7	800	250	160	110	2800	0.74	2.4	150	0.40	0.55	X103	X103 V1-A-Pack 
VBO 160-12NO7	1200	400										
VBO 160-16NO7	1600	500										
VBO 160-18NO7	1800	575										

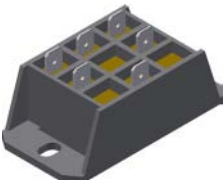
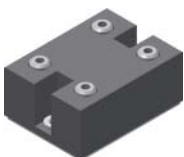
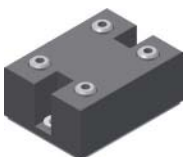

Type	V_{RRM}	V_{VRMS}	I_{dAV}	@ T_H	I_{TSM}	V_{T0}	r_T	T_{VJM}	R_{thJC}	R_{thJH}	Fig. No.	Package style
	V	V	A	°C	10 ms, 45°C A	V	mΩ	°C	K/W	K/W		Outline drawings on pages O-36...O-59
1~ Half Controlled Rectifier Bridges with free wheeling diode, B2HKF												
VHF 15-08io5	800	250	15	85	190	1.00	40.0	125	2.40	3.00	X117a	X117a FO-F-A 
VHF 15-12io5	1200	400										
VHF 15-16io5	1600	500										
VHF 25-08io7	800	250	32	$T_C = 85^\circ C$	200	0.85	27.0	125	1.30	1.80	X101	X121b PWS-C 
VHF 25-12io7	1200	400										
VHF 28-08io5	800	250	28	85	300	0.90	15.0	125	1.40	2.00		
VHF 28-12io5	1200	400									X117a	X117a PWS-C 
VHF 28-16io5	1600	500										
VHF 36-08io5	800	250	36	85	320	0.85	13.0	125	1.15	1.55		
VHF 36-12io5	1200	400									X103	X123e PWS-E 
VHF 36-16io5	1600	500										
VHFD 37-08io1	800	250	36	85	320	0.85	13.0	125	1.20	1.55		
VHFD 37-12io1	1200	400									X101	X101 PWS-E 
VHFD 37-16io1	1600	500										
1~ Half Controlled Rectifier Bridge, B2HZ												
VGO 36-16io7	1600	500	36	85	320	0.85	13.0	125	1.40	2.00	X101	

Data according to IEC 60747 and refer to a single diode or thyristor unless otherwise stated.

3~ Rectifier Bridges

3~ Rectifier Bridges with Standard Diodes, B6U

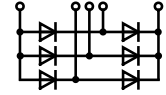

Type	V _{RRM} V	V _{vRMS} V	I _{dAV} A	@ T _C °C	I _{FSM} 45°C 10 ms A	V _{F0} V	r _F mΩ	T _{vJM} °C	R _{thJC} K/W	R _{thJH} K/W	Fig. No.	Package style Outline drawings on pages O-36...O-59
FUO 22-12N FUO 22-16N	1200 1600	400 500	30	120	150	0.81	31.0	175	3.00	3.20	X024a	X024a ISOPLUS i4-PAC™
VUO 25-08NO8 VUO 25-12NO8 VUO 25-14NO8 VUO 25-16NO8 VUO 25-18NO8	800 1200 1400 1600 1800	250 400 440 500 575	20	85	380	0.77	14.2	150	8.00	9.00	X116a	X025b GUPF
VUO 28-08NO7 VUO 28-12NO7	800 1200	250 400	30	105	120	0.84	28.8	150	2.50	2.90	X101	X101 ECO-PAC 1
VUO 36-08NO8 VUO 36-12NO8 VUO 36-14NO8 VUO 36-16NO8 VUO 36-18NO8	800 1200 1400 1600 1800	250 400 440 500 575	27	85	550	0.76	9.1	150	7.00	8.00	X116a	X103 V1-A-Pack
VUO 34-08NO1 VUO 34-12NO1 VUO 34-14NO1 VUO 34-16NO1 VUO 34-18NO1	800 1200 1400 1600 1800	250 400 440 500 575	45	110	300	0.81	14.9	150	1.70	2.10	X103	See data sheet for pin arrangement
VUO 30-08NO3 VUO 30-12NO3 VUO 30-14NO3 VUO 30-16NO3 VUO 30-18NO3	800 1200 1400 1600 1800	250 400 440 500 575	45	110	300	0.80	12.9	150	2.00	2.40	X117b	See data sheet for pin arrangement
VUO 35-12NO7 VUO 35-16NO7 VUO 35-18NO7	1200 1600 1800	400 500 575	35	85	400	0.80	12.9	150	4.20	4.80	X119a	X116a FO-B
GUO 40-08NO1 GUO 40-12NO1 GUO 40-16NO1 DMA 40U1800GU DNA 40U2200GU	800 1200 1600 1800 2200	250 400 500 575 690	40	90	370	0.74	16.3	175	4.30	4.80	X025b	X117b FO-F-B
FUO 50-16N	1600	500	50	120	270	0.78	17.0	175	2.10	2.30	X024a	X119a PWS-A
VUO 52-08NO1 VUO 52-12NO1 VUO 52-14NO1 VUO 52-16NO1 VUO 52-18NO1 VUO 52-20NO1 VUO 52-22NO1	800 1200 1400 1600 1800 2000 2200	250 400 440 500 500 575 690	60	110	350	0.83	11.5	150	1.30	1.60	X103	X120a PWS-B
VUO 50-08NO3 VUO 50-12NO3 VUO 50-14NO3 VUO 50-16NO3 VUO 50-18NO3	800 1200 1400 1600 1800	250 400 440 500 575	60	110	500	0.78	8.5	150	1.50	1.90	X117b	
VUO 55-12NO7 VUO 55-16NO7 VUO 55-18NO7	1200 1600 1800	400 500 575	60	85	750	0.76	6.9	150	2.70	3.10	X120a	

3~ Rectifier Bridges

3~ Rectifier Bridges with Standard Diodes, B6U

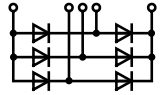





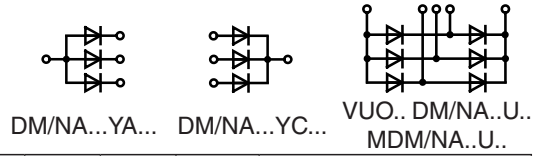

Type	V _{RRM}	V _{VRMS}	I _{dAV}	@ T _C	I _{FSM} 45°C 10 ms A	V _{F0}	r _F	T _{VJM}	R _{thJC}	R _{thJH}	Fig. No.	Package style
○ Not for new design	V	V	A	°C	A	V	mΩ	°C	K/W	K/W		Outline drawings on pages O-36...O-59
VUO 60-12NO3 VUO 60-14NO3 VUO 60-16NO3 VUO 60-18NO3	800 1400 1600 1800	250 440 500 575	75	110	700	0.77	6.5	150	1.20	1.60	X117b	X030a SMPD-B
VUO 62-08NO7 VUO 62-12NO7 VUO 62-14NO7 VUO 62-16NO7 VUO 62-18NO7	800 1200 1400 1600 1800	250 400 440 500 575	60	120	550	0.78	8.1	150	1.10	1.50	X122a	X101 ECO-PAC 1 See data sheet for pin arrangement X102 ECO-PAC 2
VUO 64-16NO7	1600	500	60	120	550	0.78	8.1	150	1.10	1.50	X122c	
VUO 68-08NO7 VUO 68-12NO7 VUO 68-16NO7	800 1200 1600	250 400 500	70	105	300	0.82	12.2	150	1.10	1.50	X101	 See data sheet for pin arrangement
○ VUO 70-16NO7	1600	500	70	100	550	0.80	8.0	150	1.45	1.90	X118d	X103 V1-A-Pack
VUO 80-08NO1 VUO 80-12NO1 VUO 80-14NO1 VUO 80-16NO1 VUO 80-18NO1	800 1200 1400 1600 1800	250 400 440 500 575	80	110	600	0.81	7.8	150	1.10	1.40	X103	
VUO 82-08NO7 VUO 82-12NO7 VUO 82-14NO7 VUO 82-16NO7 VUO 82-18NO7	800 1200 1400 1600 1800	250 400 440 500 575	90	115	750	0.78	6.0	150	0.90	1.30	X122a	X117b FO-F-B
VUO 84-16NO7	1600	500	90	115	750	0.78	6.0	150	0.90	1.30	X122c	X118d FO-T-A
VUO 86-08NO7 VUO 86-12NO7 VUO 86-16NO7	600 1200 1600	125 400 500	90	105	550	0.81	7.8	150	0.90	1.30	X101	X121a PWS-C
DMA 90U1800LB DNA 90U2200LB	1800 2200	575 690	90	110	350	0.81	12.7	175	1.10	1.50	X030a	X122a PWS-D
VUO 98-08NO7 VUO 98-12NO7 VUO 98-16NO7	800 1200 1600	250 400 500	105	115	750	0.81	5.9	150	0.70	1.00	X102	
VUO 105-12NO7 VUO 105-16NO7 VUO 105-18NO7	1200 1600 1800	400 500 575	120	105	1500	0.78	4.8	150	0.80	1.10	X121a	X122c PWS-D Flat
VUO 110-08NO7 VUO 110-12NO7 VUO 110-16NO7 VUO 110-18NO7	800 1200 1600 1800	250 400 500 575	125	110	1200	0.79	4.5	150	0.70	1.00	X123c	X123c PWS-E
➤ MDMA 120U1600VA	1600	500	120	110	850	0.79	5.9	150	0.65	0.85	X103	
➤ MDMA 150U1600VA	1600	500	150	110	1100	0.83	4.7	150	0.50	0.70		

Data according to IEC 60747 and refer to a single diode or thyristor unless otherwise stated.

3~ Rectifier Bridges

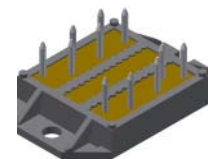
3~ Rectifier Bridges with Standard Diodes, B6U

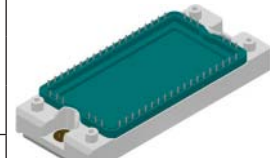
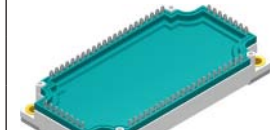

Type	V _{RRM}	V _{VRMS}	I _{dAV}	@ T _C	I _{FSM} 45°C 10 ms	V _{F0}	r _F	T _{VJM}	R _{thJC}	R _{thJH}	Fig. No.	Package style
➤ New	V	V	A	°C	A	V	mΩ	°C	K/W	K/W		Outline drawings on pages O-36...O-59
VUO 121-16NO1	1600	500	120	105	700	0.80	7.6	150	0.65	0.75	X112	X027a SOT-227B miniBLOC 
VUO 122-08NO7	800	250	125	115	1000	0.80	4.6	150	0.60	0.90	X102	
VUO 122-12NO7	1200	400										
VUO 122-16NO7	1600	500										
VUO 125-12NO7	1200	400	150	110	1800	0.76	3.6	150	0.60	0.90	X121a	X102 ECO-PAC 2  See data sheet for pin arrangement
VUO 125-16NO7	1600	500										
VUO 125-18NO7	1800											
DNA 90YA2200NA DNA 90YC2200NA	2200	690	90	85	370	0.86	11.4	150	1.20	1.30	X027a	
DMA 150YA1600NA DMA 150YC1600NA	1600	500	150	95	700	0.82	6.3	150	0.60	0.70	X104	V2-Pack  See data sheet for pin arrangement
DMA 200YA1600NA DMA 200YC1600NA			200	100	1000	0.86	4.4	150	0.45	0.55		
DMA 240YA1600NA DMA 240YC1600NA			240	100	1300	0.86	4.0	150	0.35	0.45		
VUO 160-08NO7	800	250	175	110	1800	0.77	3.4	150	0.50	0.70	X123c	X112 E2-Pack  See data sheet for pin arrangement
VUO 160-12NO7	1200	400										
VUO 160-16NO7	1600	500										
VUO 160-18NO7	1800	575										
VUO 162-16NO7	1600	500	175	110	1800	0.77	3.4	150	0.50	0.70	X123h	X112 E3-Pack PFP 
VUO 190-08NO7	800	250	240	110	2800	0.74	2.4	150	0.40	0.55	X123c	
VUO 190-12NO7	1200	400										
VUO 190-16NO7	1600	500										
VUO 190-18NO7	1800	575										
VUO 192-16NO7	1600	500	240	110	2800	0.74	2.4	150	0.40	0.55	X123h	
MDNA 240U2200ED	2200	690	240	90	1500	0.79	5.1	150	0.35	0.45	X112	
MDMA 450U1600PTEH	1600	450	500	85	2400	0.82	2.7	150	0.20	0.10	X113a	PWS-E Flat 
MDMA 660U1600PTEH	1600	500	660	85	5000	0.77	1.8	150	0.15	0.075		
MDNA 660U2200PTEH	2200	690										
MDMA 900U1600PTEH	1600	500	900	85	8000	0.76	1.4	150	0.10	0.05		

X123h

PWS-E Flat



X123c

PWS-E



X121a



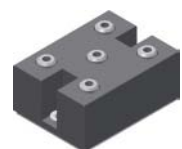

PWS-C

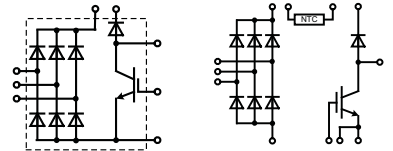

3~ Rectifier Bridges

3~ Rectifier Bridges
with IGBT and Fast Diode for Brake Unit

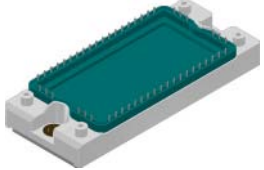

Type	Rectifier			IGBT		Fast Diode			Fig. No.	Package style Outline drawings on pages O-36...O-59
	V_{RRM} V	I_{dAV} A	@ T_C °C	V_{CES} V	I_{C80} A	V_{RRM} V	$I_{F(AV)}$ A	t_{rr} ns		
➤ New										
VUB 72-12NOXT	1200	75	110	1200	40	1200	21	130	X103	X103 V1-A-Pack  See data sheet for pin arrangement
VUB 72-16NOXT	1600									
VUI 72-16NOXT	1600	75	110	1200	40	-	-	-		
VUB 116-16NOXT	1600	120	105	1200	84	1200	32	150	X112	
VUB 120-16NOX	1600	180	90	1200	140	1200	32	300	X104	X104 V2-Pack  See data sheet for pin arrangement
VUB 120-16NOXT										
VUB 135-22NO1	2200	150	105	1700	80	1700	33	900	X112	
VUB 145-16NOXT	1600	150	105	1200	140	1200	32	300		
VUB 160-16NOX	1600	180	90	1200	175	1200	32	150	X104	X112 E2-Pack  See data sheet for pin arrangement
VUB 160-16NOXT										
MDMA 210UB1600PTED	1600	210	85	1200	84	1200	59	350	X112a	
MDNA 210UB2200PTED	2200	210	85	1700	100	1700	54	550	X112	
➤ MDNA 210UB2200TED										
MDMA 240UB1600ED	1600	240	85	1200	140	1200	59	350	X112	X112a E2-Pack PFP  See data sheet for pin arrangement
MDMA 280UB1600PTED	1600	280	85	1200	140	1200	59	350	X112a	
MDNA 280UB2200PTED	2200	280	85	1700	100	1700	54	550		
MDMA 360UB1600PTED	1600	360	85	1200	175	1200	90	350		
MDNA 360UB2200PTED	2200	360	85	1700	145	1700	83	550		
MDMA 450UB1600PTED	1600	450	85	1200	175	1200	90	350		
➤ MDMA 450UB1600PTEH	1600	450	85	1200	175	1200	90	350	X113a	

3~ Half Controlled Rectifier Bridges

with IGBT and Fast Diode for Brake Unit

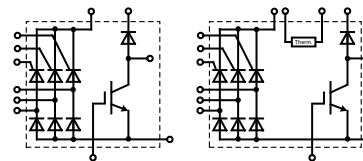

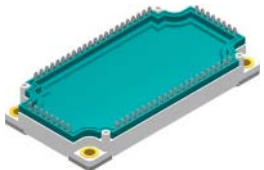
Type	Rectifier			IGBT		Fast Diode			Fig. No.	Package style Outline drawings on pages O-36...O-59
	V_{RRM} V	I_{dAV} A	@ T_C °C	V_{CES} V	I_{C80} A	V_{RRM} V	$I_{F(AV)}$ A	t_{rr} ns		
➤ New										
VVZB 120-16ioX	1600	180	85	1200	140	1200	32	300	X104	X112a E3-Pack PFP  See data sheet for pin arrangement
MCNA 120UI2200TED	2200	117	80	1700	80	1700	50	550	X112	
➤ MCNA 120UI2200PED	2200	120	80	1700	80	1700	50	550	X112a	
VVZB 135-16ioXT	1600	150	85	1200	84	1200	32	150	X112	
VVZB 170-16ioXT	1600	180	85	1200	140	1200	32	300	X112	
MCMA 240UI1600ED	1600	240	80	1200	140	1200	59	350	X112	
MCMA 240UI1600PED									X112a	
MCMA 245UI1600ED	1600	240	80	1200	175	1200	90	350	X112	

3~ Rectifier Bridges

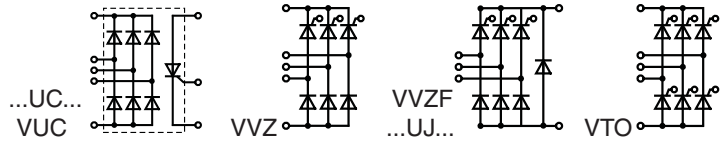

Type	V_{RRM}	V_{VRMS}	I_{dAVM}	@ T_H	$I_{FSM/TSM}$	V_{TO}	r_T	T_{VJM}	R_{thJC}	R_{thJH}	Fig. No.	Package style Outline drawings on pages O-36...O-59
➤ New	V	V	A	°C	10 ms, 45°C A	V	mΩ	°C	K/W	K/W		

3~ Rectifier Bridges with Standard or Fast Diodes ($t_{rr} = 1.5$ ms) & Integrated Softstart Thyristor

VUC 36-12go2	1200	400	34	85	Dio.	300	1.20	16	125	1.40	2.00	X105a
					Thy.	400	0.85	10	125	0.90	1.10	
VUC 36-16go2	1600	500	34	85	Dio.	300	1.20	16	125	1.40	2.00	X105a
					Thy.	400	0.85	10	125	0.90	1.10	
MDMA 60UC1600VC	1600	500	60	110	Dio.	350	0.83	11.5	150	1.30	1.60	X105c
					Thy.	800	0.89	5.3	140	0.70	0.90	
➤ MDMA 360UC1600TED	1600	500	360	85	Dio.	1900	0.82	3.4	150	0.25	0.35	X112
					Thy.	2400	0.84	3.1		0.17	0.25	

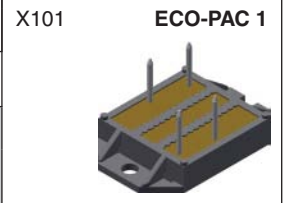
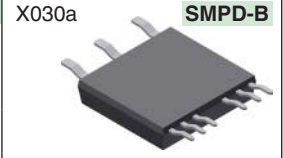

Type	V_{RRM}	V_{VRMS}	I_{dAVM}	@ T_H	$I_{FSM/TSM}$	V_{TO}	r_T	T_{VJM}	R_{thJC}	R_{thJH}	Fig. No.
○ Not for new design	V	V	A	°C	10 ms, 45°C A	V	mΩ	°C	K/W	K/W	

See data sheet for pin arrangement

3~ Half Controlled Rectifier Bridges, B6HK

VVZ 39-08ho7	800	250	39	85	200	0.85	27.0	125	1.30	1.80	X101
VVZ 39-12ho7	1200	400									X105a
VVZ 40-12io1	1200	400	34	100	320	0.85	15.0	125	1.00	1.60	X105a
VVZ 40-16io1	1600	500									X105a
CLE 90UH1200TLB	1200	400	90	90	350	0.92	13.0	150	0.90	1.30	X030a
VVZ 110-12io7	1200	400	110	85	1150	0.85	6.0	125	0.65	0.80	X123b
VVZ 175-12io7	1200	400	167	85	1500	0.85	3.5	125	0.46	0.55	X123b
VVZ 175-16io7	1600	500									X123b
MCMA 450UH1600TEH	1600	500	450	90	2400	0.84	3.1	150	0.17	0.25	X113

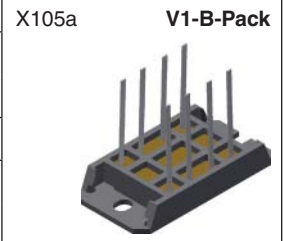

3~ Half Controlled Rectifier Bridges with free wheeling diode, B6HKF

MCMA 120UJ1800ED	1800	575	117	80	500	0.89	13.6	150	0.65	0.75	X112
○ VVZF 70-16io7	1600	500	70	85	550	0.85	11.0	125	0.90	1.10	X118c

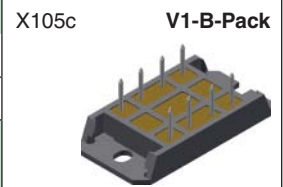

3~ Full Controlled Rectifier Bridges, B6C

VTO 39-08ho7	800	250	39	85	200	0.85	27.0	125	1.30	1.80	X101
VTO 39-12ho7	1200	400									X101

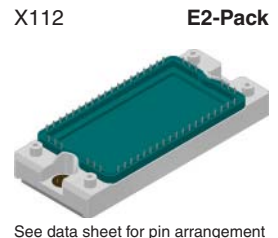
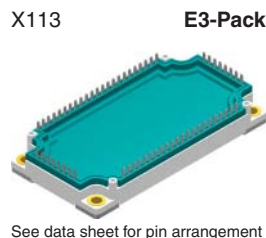
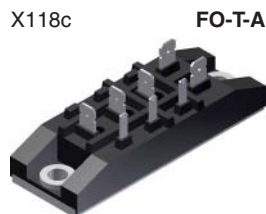

See data sheet for pin arrangement

See data sheet for pin arrangement

AC Controller 1~/2~/3~

$I_{RMS} = 35 - 230 \text{ A}$

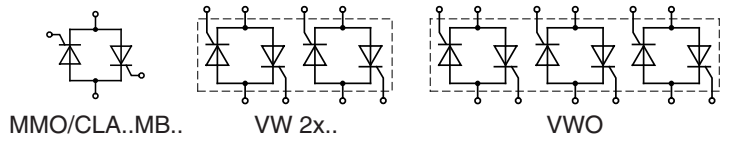

Type	V_{RRM}	V_{VRMS}	I_{RMS}	@ T_c	I_{TSM} 10 ms 45°C	V_{TO}	r_T	T_{VJM}	R_{thJC}	R_{thJH}	Fig. No.	Package style	
> New	V	V	A	°C	A	V	mΩ	°C	K/W	K/W		Outline drawings on pages O-36...O-59	
1~	MMO 62-12io6	1200	400	66	95	400	0.87	13.6	150	0.90	1.10	X027a	SOT-227B miniBLOC
	MMO 62-16io6	1600	500										
	MMO 74-12io6	1200	400	88	95	600	0.87	10.5	150	0.70	0.80		
	MMO 74-16io6	1600	500										
	MMO 90-12io6	1200	400	110	95	800	0.88	6.0	150	0.60	0.70		
	MMO 90-14io6	1400	440										
	MMO 90-16io6	1600	500										
	CLA 110MB1200NA	1200	400	110	110	1100	0.78	4.9	150	0.55	0.65		
	MMO 110-12io7	1200	400	112	85	1000	0.85	5.6	150	0.80	0.92	X101	ECO-PAC 1
	MMO 110-14io7	1400	440										
	MMO 140-12io7	1200	400	130	85	1150	0.85	5.2	150	0.70	0.82		
	MMO 140-16io7	1600	500										
MMO 175-12io7	1200	400	175	85	1500	0.85	3.7	150	0.50	0.62			
MMO 175-16io7	1600	500											
MMO 230-12io7	1200	400	230	85	2250	0.80	2.4	125	0.26	0.46	X102	ECO-PAC 2	
MMO 230-16io7	1600	500											
2~	VW 2x60-12io1	1200	400	2x 60	85	520	0.85	11.0	125	0.92	1.22	X103	V1-A-Pack
	VW 2x60-14io1	1400	440										
	VW 2x60-16io1	1600	500										
3~	VWO 35-08ho7	800	250	3x 35	85	200	0.85	27.0	125	1.30	1.80	X101	See data sheet for pin arrangement
	VWO 35-12ho7	1200	400										

TRIAC 1~

$I_{RMS} = 30 - 650 \text{ A}$

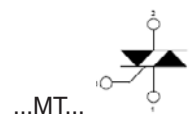





CLA 30MT1200NPB	1200	400	33	120	170	0.89	30.5	150	0.95	1.45	X005a	X132a	Y1-2-Cu	
CLA 30MT1200NPZ										1.20	X011c			
CLA 40MT1200NPB	1200	400	44	110	180	0.89	27.9	150	0.80	1.30	X005a	X019a	TO-268AAHV	
CLA 40MT1200NPZ										1.05	X011c			
> CLA 40MT1200NHB											X014a			
CLA 40MT1200NHR				95						1.30	1.55			X016c
CLA 60MT1200NHB	1200	400	66	120	380	0.86	12.5	150	0.55	0.80	X014a	X019a	TO-268AAHV	
CLA 60MT1200NTZ										0.70	X019a			
CLA 60MT1200NHR				100						0.90	1.15			X016c
CMA 60MT1600NHB	1600	500	66	115	260	0.90	16.6	150	0.55	0.80	X014a			
CMA 60MT1600NHR				90						0.90	1.15	X016c		
CLA 80MT1200NHB	1200	400	88	120	480	0.85	9.2	150	0.40	0.65	X014a	X019a	TO-268AAHV	
CLA 80MT1200NHR				100						0.65	0.90			X016c
CMA 80MT1600NHB	1600	400	88	115	400	0.90	12.0	150	0.40	0.65	X014a			
CMA 80MT1600NHR		500		95						0.65	0.90			X016c
MCMA 650MT1400NKD	1400	440	650	85	9600	0.81	0.68	140	0.12	0.04	X132a	X132a	ISO247™	
MCMA 650MT1800NKD	1800	575									X132a			



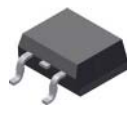

Data according to IEC 60747 and refer to a single diode or thyristor unless otherwise stated.

TRIACS

Triacs are useful in full-wave AC applications to control AC power either through full-cycle switching or phase control of current to the load element. These Triacs are rated to block voltage in the OFF condition from 400 V minimum with selected products capable of 1000 V operation. Typical applications include motor speed controls, heater controls, and incandescent light controls.

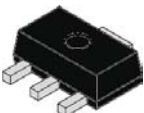
Type	V _{DRM}	I _{T(RMS)}	@ T _C	I _{TSM}	I _{GT}	T _J	Fig. No.	Package style
➤ New	V	A	°C	20 ms A	QI-QII-QIII (-QIV) A	°C		Outline drawings on pages O-60...O-64
LX807MTRP	600	0.8	90	8	5-5-5-7	125	L001	L001 SOT-223 
LX807MBRP	600	0.8	60	8	5-5-5-7	125	L016	
L0103NERP	800	1	50	10	3-3-3-5	125	L006	
L0107NTRP	800	1	90	10	5-5-5-7	125	L001	
L0109NERP	800	1	50	10	10-10-10-10	125	L006	
LJ6004D8RP	600	4	135	40	10-10-10-20	150	L004	
QJ6004D4RP	600	4	135	40	25-25-25-50	150	L004	L002 TO-218AC 
Q8004D4RP	800	4	110	46	25-25-25-50	125	L004	
QJ6006DH4RP	600	6	130	60	35-35-35	150	L004	
Q8006RH4TP	800	6	100	80	35-35-35	125	L005a	
QJ6008DH4RP	600	8	120	70	35-35-35	150	L004	
Q8008LH4TP	800	8	90	83	35-35-35	125	L005c	
Q6012LH1LEDTP	600	12	90	110	40461	125	L005c	
QJ8012LH5TP	800	12	120	110	50-50-50	150	L005c	
Q8015LTP	800	15	80	167	50-50-50-100	125	L005c	
QJ6016NH2RP	600	16	130	167	40461	150	L011b	
QJ6016RH3TP	600	16	130	167	20-20-20	150	L005a	L002a TO-218X 
QJ6016LH4TP	600	16	115	167	35-35-35	150	L005c	
QJ6016NH6RP	600	16	130	167	80-80-80	150	L011b	
QJ8016NH4RP	800	16	132	167	35-35-35	150	L011b	
QJ8016LH6TP	800	16	110	167	80-80-80	150	L005c	
QJ6025NH5RP	600	25	120	208	50-50-50	150	L011b	
QJ6025RH5TP	600	25	120	208	50-50-50	150	L005a	L004 TO-252AA 
QJ6025LH5TP	600	25	90	208	50-50-50	150	L005c	
QJ6025KH6TP	600	25	110	208	80-80-80	150	L002	
QJ8025LH5TP	800	25	90	208	50-50-50	150	L005c	
Q8025K6TP	800	25	85	208	80-80-80	125	L002	
QJ8025NH5RP	800	25	120	208	50-50-50	150	L011b	
➤ QJ8030LH4TP	800	30	105	290	35-35-35	150	L005c	L005a TO-220AB 
Q6035NH5RP	600	35	90	290	50-50-50	125	L011b	
Q8040K3TP	800	40	75	335	35-35-35-70	125	L002	
QK040K4TP	1000	40	75	335	50-50-50-120	125	L002	
Q8040K5TP	800	40	75	335	50-50-50	125	L002	
QK040J7TP	1000	40	75	335	100-100-100	125	L002a	
➤ QJ8040KH5TP	800	40	100	420	50-50-50	150	L002	

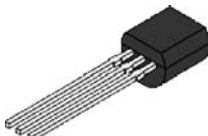
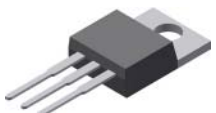
L016	SOT-89	L011b	TO-263AB	L006	TO-92	L005c	TO-220AB (ISO)
							

1~ / 3~ High Voltage Rectifier Modules

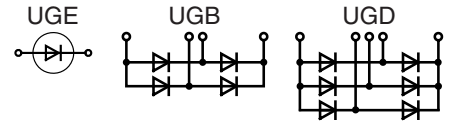

Type	V_{RRM} V	I_{dAV} ① / ② A	I_{FSM} 10 ms, 45°C A	V_{F0} V	r_F mΩ	T_{VJM} °C	R_{thJA1} ① K/W	R_{thJA2} ② K/W	Fig. No.	Package style Outline drawings on pages O-36...O-59
UGE 0421AY4	3200	23 / 7.4	300	1.70	16	150	1.9	7.1	X251	
UGE 0221AY4	4800	10 / 3.8	180	2.55	90	150	1.7	8.0		
UGE 1112AY4	8000	4.2 / 2.0	120	4.25	215	150	4.2	10.0		
UGE 3126AY4	24000	2.0 / 0.8	70	12.00	1800	150	2.7	8.7		
UGB 3132AD	4800	1.3	60	-	-	150	-	-	X252	
UGB 6124AG	10500	1.0	50	-	-	150	-	-	X253b	
UGD 6123AG	7200	1.8	50	-	-	150	-	-	X253a	
UGD 8124AG	10500	1.2								

Data according to IEC 60747-2/6

① for oil-cooling with cooling plate, $T_A = 35^\circ\text{C}$

② for natural air cooling without cooling plate, $T_A = 45^\circ\text{C}$

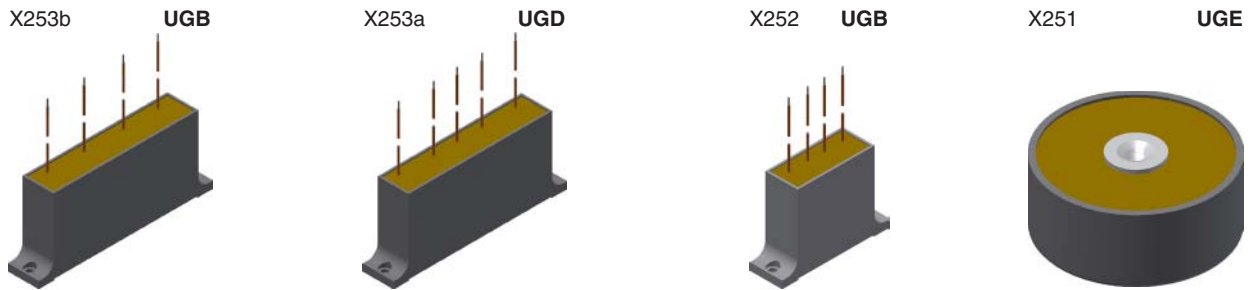

Braking Rectifier Assemblies

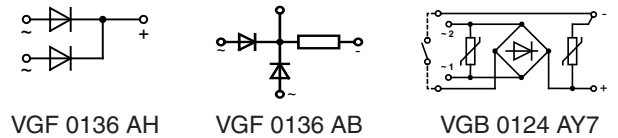

Type	V_{VRMS} typ. V	V_{dAV} typ. V	I_{dAVM} typ. A	I_{dAVM} max. A	V_{RRM} max. V	I_{FSM} max. A	I^2t max. A ² s	Fig. No.	Package style Outline drawings on pages O-36...O-59
VGB 0124AY7a	380	340	1.0	1.0	1400	60	28	X254	
VGF 0136AB	1000	440	1.2	1.5	2800	80	40	X255	

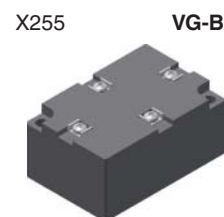
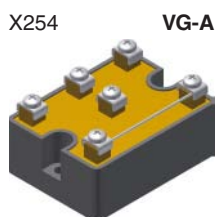

Break-Over Diodes

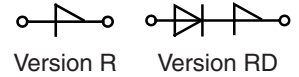

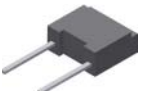
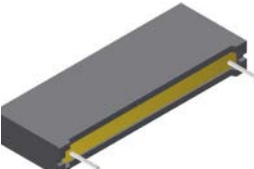
Type	V_{BO} $T_{VJ} = 25\text{ }^{\circ}\text{C}$ $K_T = 2 \cdot 10^{-3}\text{ K}^{-1}$ V	I_{BO} mA	I_H mA	V_H V	I_D $T_{VJ} = 125\text{ }^{\circ}\text{C}$ $V_D = 0.8 \cdot V_{BO}$ μA	$I_{AVM} \textcircled{1}$ $T_{amb} = 50\text{ }^{\circ}\text{C}$ A	I_{SM} A	dv/dt V/ μs	R_{thJA} K/W	Fig. No.	Package style Outline drawings on pages O-36...O-59
IXBOD 1-06 IXBOD 1-07 IXBOD 1-08 IXBOD 1-09 IXBOD 1-10	600 \pm 50 700 800 900 1000	< 15	30	4-8	20	0.90	200	>1000	60	X201	<p>X201 FP-Case (oil proof)</p>  <p>X202 BOD-Package</p> 
IXBOD 1-12R IXBOD 1-12RD IXBOD 1-13R IXBOD 1-13RD IXBOD 1-14R IXBOD 1-14RD IXBOD 1-15R IXBOD 1-15RD IXBOD 1-16R IXBOD 1-16RD IXBOD 1-17R IXBOD 1-17RD IXBOD 1-18R IXBOD 1-18RD IXBOD 1-19R IXBOD 1-19RD IXBOD 1-20R IXBOD 1-20RD	1200 \pm 50 1300 1400 1500 1600 1700 1800 1900 2000	< 15	30	4-8	100	0.90	200	>1500	20	X202	
IXBOD 1-21R IXBOD 1-21RD IXBOD 1-22R IXBOD 1-22RD IXBOD 1-23R IXBOD 1-23RD IXBOD 1-24R IXBOD 1-24RD IXBOD 1-25R IXBOD 1-25RD	2100 \pm 50 2200 2300 2400 2500	< 15	30	4-8	100	0.90	200	>2500	20		
IXBOD 1-26R IXBOD 1-26RD IXBOD 1-28R IXBOD 1-28RD IXBOD 1-30R IXBOD 1-30RD IXBOD 1-32R IXBOD 1-32RD	2600 \pm 100 2800 3000 3200	< 15	30	4-8	100	0.90	200	>3500	20		
IXBOD 1-34R IXBOD 1-36R IXBOD 1-38R IXBOD 1-40R IXBOD 1-42R	3400 \pm 100 3600 3800 4000 4200	< 15	30	4-8	100	0.90	200	>3500	20		

① Leads soldered on PCB board, T_{stg} and $T_{VJ} = -40 \dots +125\text{ }^{\circ}\text{C}$

Break-Over-Diodes Sets

We deliver also:

- Special selection of more than 2 pcs IXBOD1-... for every break down voltage of $V_{BO} > 2000\text{ V}$

- Example

type designation IXBOD Set SA05/00

$V_{BO} = 4700\text{ V } \pm 100\text{ V}$

(we deliver 5 pcs single selected IXBOD1-... in one plastic bag)

Customers use these products on PCB connected in series with parallel resistor $R = 10\text{ M}\Omega$ across each IXBOD

IXBOD 2 - Fast Break-Over Diodes

Advantages compared with IXBOD 1:

- Temperature coefficient K_T reduced by a factor of 3
 - tighter definition of the break-over voltage V_{BO}
 - $V_{BO}(T_{VJ}) = V_{BO, 25^\circ C} [1 + K_T (T_{VJ} - 25^\circ C)]$
 - more precise and controllable design due to smaller tolerances
- Significant reduction of the switching-on time down to a few nanoseconds

Applications:

- Protection circuits for thyristors in high valuable designs
 - high DC current power transmissions for long distances like offshore windmills or hydroelectric dams
- High Intensity Discharge Lighting (HID)

Fast Break-Over Diodes

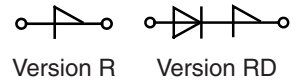

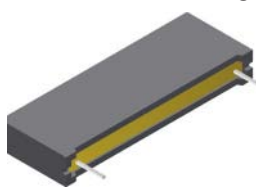
Type	V_{BO} $T_{VJ} = 25^\circ C$ $K_T = 0.7 \cdot 10^{-3} K^{-1}$ V	I_{BO} mA	I_H $T_{VJ} = 25^\circ C$ mA	V_H V	I_D $T_{VJ} = 125^\circ C$ $V_D = 0.8 \cdot V_{BO}$ μA	I_{AVM} ① $T_{amb} = 50^\circ C$ A	I_{SM} A	dv/dt V/ μs	R_{thJA} K/W	Fig. No.	Package style Outline drawings on pages O-36...O-59
IXBOD 2-01	100	15	20	4-8	200	0.90	250	>1000	60	X201	X201 FP-Case (oil proof) 
IXBOD 2-02	200 $\pm 10\%$										
IXBOD 2-03	300 $\cdot V_{BO}$										
IXBOD 2-04	400										
IXBOD 2-05	500 ± 50										
IXBOD 2-06	600										
IXBOD 2-07	700										
IXBOD 2-08	800										
IXBOD 2-09	900										
IXBOD 2-10	1000										
IXBOD 2-11	1100										
IXBOD 2-12	1200										
IXBOD 2-13	1300										
IXBOD 2-14	1400										
IXBOD 2-15R	1500 ± 50	15	20	4-8	200	0.90	250	>1500	20	X202	X202 BOD-Package 
IXBOD 2-15RD	1600										
IXBOD 2-16R	1600										
IXBOD 2-16RD	1700										
IXBOD 2-17R	1700										
IXBOD 2-17RD	1800										
IXBOD 2-18R	1800										
IXBOD 2-18RD	1900										
IXBOD 2-19R	1900										
IXBOD 2-19RD	2000										
IXBOD 2-20R	2000										
IXBOD 2-20RD	2100										
IXBOD 2-21R	2100										
IXBOD 2-21RD	2200										
IXBOD 2-22R	2200										
IXBOD 2-22RD	2300										
IXBOD 2-23R	2300										
IXBOD 2-23RD	2400										
IXBOD 2-24R	2400										
IXBOD 2-24RD	2500										
IXBOD 2-25R	2500										
IXBOD 2-25RD	2600 ± 100										
IXBOD 2-26R	2600 ± 100										
IXBOD 2-26RD	2700										
IXBOD 2-27R	2700										
IXBOD 2-27RD	2800										
IXBOD 2-28R	2800										
IXBOD 2-28RD											

Fast Break-Over Diodes

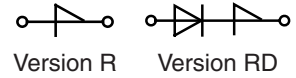

Type	V_{BO}	I_{BO}	I_H	V_H	I_D	I_{AVM} ①	I_{SM}	dv/dt	R_{thJA}	Fig. No.	Package style Outline drawings on pages O-36...O-59		
	$T_{VJ} = 25\text{ °C}$ $K_T = 0.7 \cdot 10^{-3}\text{ K}^{-1}$ V	mA	$T_{VJ} = 25\text{ °C}$ mA	V	$T_{VJ} = 125\text{ °C}$ $V_D = 0.8 \cdot V_{BO}$ μA	$T_{amb} = 50\text{ °C}$ A	A	V/μs	K/W				
➤ IXBOD 2-29R	2900 ±100	15	20	4-8	200	0.90	250	>2500	20	X202	<p>X202 BOD-Package</p>		
IXBOD 2-29RD													
IXBOD 2-30R	3000												
IXBOD 2-30RD													
IXBOD 2-31R	3100												
IXBOD 2-31RD													
IXBOD 2-32R	3200												
IXBOD 2-32RD													
IXBOD 2-33R	3300												
IXBOD 2-33RD													
IXBOD 2-34R	3400												
IXBOD 2-34RD													
IXBOD 2-35R	3500												
IXBOD 2-35RD													
IXBOD 2-36R	3600												
IXBOD 2-36RD													
IXBOD 2-37R	3700												
IXBOD 2-37RD													
IXBOD 2-38R	3800												
IXBOD 2-38RD													
IXBOD 2-39R	3900												
IXBOD 2-39RD													
IXBOD 2-40R	4000												
IXBOD 2-40RD													
IXBOD 2-41R	4100												
IXBOD 2-41RD													
IXBOD 2-42R	4200												
IXBOD 2-42RD													
IXBOD 2-43R	4300 ±100	15	20	4-8	200	0.90	250	>3500	20				
IXBOD 2-44R	4400												
IXBOD 2-45R	4500												
IXBOD 2-46R	4600												
IXBOD 2-47R	4700												
IXBOD 2-48R	4800												
IXBOD 2-49R	4900												
IXBOD 2-50R	5000												
IXBOD 2-51R	5100												
IXBOD 2-52R	5200												
IXBOD 2-53R	5300												
IXBOD 2-54R	5400												
IXBOD 2-55R	5500												
IXBOD 2-56R	5600												

① Leads soldered on PCB board, T_{stg} and $T_{VJ} = -40 \dots +125\text{ °C}$

Solid State Relays

<p>Type BI</p> <p>± Load</p>	<p>Type BI+ (BI)</p> <p>± Load Do Not Use ± Load</p>	<p>Type UNI</p> <p>+ Load - Load</p>	<p>Type BI+ (UNI)</p> <p>+ Load - Load</p>
<p>Polarity Independent</p>		<p>Polarity Dependent</p>	
<p>Control Input</p>		<p>Control Input</p>	
<p>Load Voltage</p>		<p>Load Voltage</p>	
<p>Load Current</p>		<p>Load Current</p>	
<p>All waveforms are into a resistive load</p>			
<p>Type BI relays conduct load current in both directions.</p>			
<p>Type BI+ relays, in BI configuration, conduct load current in both directions.</p>			
<p>Type UNI relays conduct load current from the positive terminal to the negative terminal only.</p>			
<p>Type BI+ relays, in UNI configuration with output MOSFETs wired in parallel, enable higher load current from positive terminal to negative terminal only.</p>			
<p>The accompanying SSR tables reference these types (BI, BI+, & UNI) for all devices listed.</p>			

- **Replace electromechanical relays**
- **Replace mechanical switches**
- **Implement computer control of electromechanical circuits**

Applications:

- Telecommunications/ data communications
- Instrumentation
- Multiplexers
- Data acquisition/ electronic switching
- Meters (Watt-hour, water, gas)
- Medical equipment (patient/equipment isolation)
- Security
- Industrial controls

Features:

- Low drive current
- High reliability
- No EMI/RFI generation
- Arc-free with no snubbing circuits
- AC or DC switching
- Current limiting devices available
- FCC compatible
- Low off-state leakage

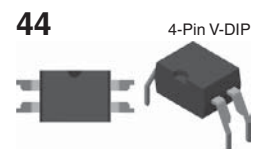
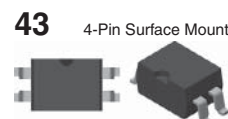
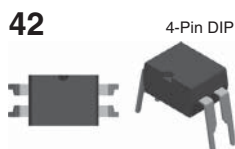
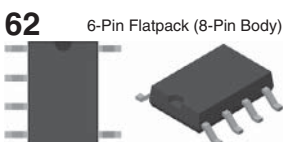
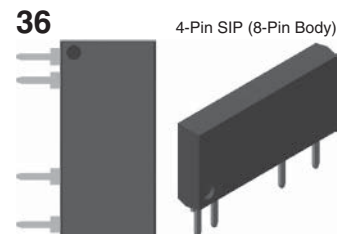
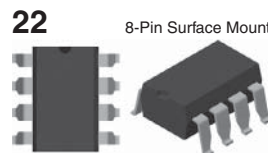
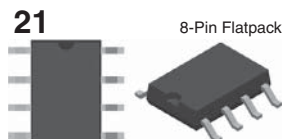
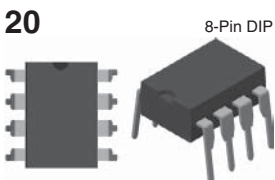
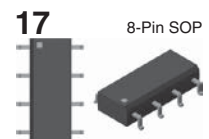
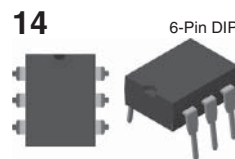
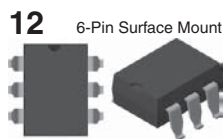
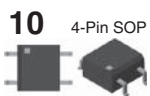

1-Form-A Relays (Normally Open)

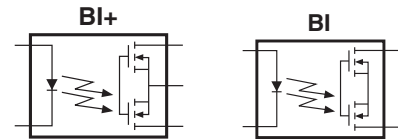

1-Form-A Relays: Single-Pole

Part Number	Relay Type	Blocking Voltage	Load Current	On Resistance	Input Control Current	Switching Speeds	Isolation Voltage	Off-State Leakage	Package Type
		V_P	mA	Ω	mA	t_{on} / t_{off} ms	V_{rms}	μA	Page 119
CPC1006N	BI	60	75	10	0.5	10 / 10	1500	1	10
CPC1008N	BI	100	150	8	2	2 / 1	1500	1	10
CPC1009N	BI	100	150	8	2	2 / 0.5	1500	0.02	10
CPC1010N	BI	250	170	11.5	2	3 / 3	1500	1	10
CPC1014N	BI	60	400	2	2	2 / 1	1500	1	10
CPC1016N	BI	100	100	16	2	2 / 1	1500	1	10
CPC1017N	BI	60	100	16	1	10 / 10	1500	1	10
CPC1018N	BI	60	600	0.8	1	3 / 2	1500	1	10
CPC1019N	BI	60	750	0.6	2	3 / 3	1500	1	10
CPC1020N	BI	30	1200	0.25	2	3 / 3	1500	1	10
CPC1025N	BI	400	120	30	2	2 / 1	1500	1	10
CPC1030N	BI	350	120	30	2	2 / 1	1500	1	10
CPC1035N	BI	350	100	35	2	2 / 1	1500	1	10
CPC1225N	BI	400	120	30	2	2 / 1	1500	1	10
CPC1230N	BI	350	120	30	2	2 / 1	1500	1	10
CPC1317	BI	70	150	16	1	2.5 / 2.5	3750	1	21
CPC1330	BI	350	120	30	2	2 / 1	5000	1	42, 43
CPC1335	BI	350	100	35	1	10 / 10	3750	1	21
CPC1390	BI	400	140	22	2	1 / 1	5000	1	42, 43, 44
CPC1393	BI	600	90	50	2	5 / 5	5000	1	42, 43, 44
CPC1394	BI	600	120	35	2	5 / 3	5000	1	42, 43, 44
CPC1510	BI+	250	200	15	2	2 / 2	3750	1	12, 14
CPC1511	BI	230	450	4	2.5	4 / 2	3750	1	36
CPC1540	BI+	350	120	25	2	2 / 2	3750	1	12, 14
CPC1560	BI+	60	300	5.6	1.1	0.1 / 0.4	3750	1	20, 22
CPC1563	BI+	600	120	35	2	2 / 2	3750	1	12, 14
CPC1593	BI+	600	120	35	2	2 / 2	3750	1	12, 14
LCA100	BI+	350	120	25	5	5 / 5	3750	1	12, 14
LCA100L	BI+	350	120	25	5	5 / 5	3750	1	12, 14
LCA110	BI+	350	120	35	2	3 / 3	3750	1	12, 14
LCA110L	BI+	350	120	35	2	3 / 3	3750	1	12, 14
LCA120	BI+	250	170	20	5	3 / 3	3750	1	12, 14
LCA120L	BI+	250	150	20	5	3 / 3	3750	1	12, 14
LCA125	BI+	300	170	16	5	5 / 5	3750	1	12, 14
LCA125L	BI+	300	170	20	5	5 / 5	3750	1	12, 14

1-Form-A Relays (Normally Open)

1-Form-A Relays: Single-Pole

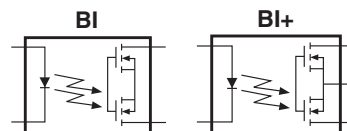

Part Number	Relay Type	Blocking Voltage	Load Current	On Resistance	Input Control Current	Switching Speeds	Isolation Voltage	Off-State Leakage	Package Type
		V_p	mA	Ω	mA	t_{on} / t_{off} ms	V_{rms}	μA	Page 119
LCA127	BI+	250	200	10	5	5 / 5	3750	1	12, 14
LCA127L	BI+	250	170	15	5	5 / 5	3750	1	12, 14
LCA129	BI+	250	170	20	2	8 / 8	3750	1	12, 14
LCA182	BI+	350	120	35	0.25	3 / 3	3750	1	12, 14
LCA701	BI+	100	1500	0.3	2	4 / 1	3750	1	12, 14
LCA710	BI+	60	1000	0.5	10	2.5 / 0.25	3750	1	12, 14
LCA712	BI+	60	1000	0.5	10	2.5 / 0.35	3750	0.01	12, 14
LCA715	BI+	60	2200	0.15	5	2.5 / 0.25	3750	1	12, 14
LCA717	BI+	30	2000	0.15	2	3 / 3	3750	1	12, 14
OMA160	BI+	250	50	100	10	0.125 / 0.125	3750	0.025	12, 14
PLA110	BI+	400	150	22	5	1 / 0.5	3750	1	12, 14
PLA110L	BI+	400	150	25	5	1 / 0.25	3750	1	12, 14
PLA132	BI+	60	600	1	2	5 / 2	3750	1	12, 14
PLA134	BI+	100	350	3	5	5 / 5	3750	1	12, 14
PLA140	BI+	400	250	8	5	3 / 1	3750	1	12, 14
PLA140L	BI+	400	200	13	5	5 / 3	3750	1	12, 14
PLA143	BI+	600	100	50	2	5 / 5	4000	1	12, 14
PLA150	BI+	250	250	7	5	2.5 / 0.5	3750	1	12, 14
PLA160	BI+	300	50	100	10	0.05 / 0.05	3750	0.025	12, 14
PLA170	BI+	800	100	50	5	5 / 5	3750	1	12, 14
PLA171	BI	800	100	50	2	5 / 5	5000	1	62
PLA172P	BI	800	100	50	2	5 / 5	5000	1	62
PLA190	BI+	400	150	22	5	1 / 0.5	5000	1	12, 14
PLA191	BI+	400	250	8	5	3 / 1	5000	1	12, 14
PLA192	BI+	600	150	22	5	5 / 5	5000	1	12, 14
PLA193	BI+	600	100	50	5	5 / 5	5000	1	12, 14
PLA194	BI+	600	130	35	2	3 / 2	5000	1	12, 14
XCA170	BI+	350	100	50	5	5 / 5	3750	1	12, 14

1-Form-A Relays (Normally Open)

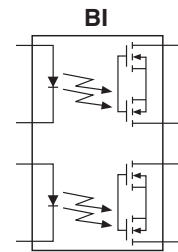

1-Form-A Relays: Dual Single-Pole

Part Number	Relay Type	Blocking Voltage	Load Current	On Resistance	Input Control Current	Switching Speeds	Isolation Voltage	Off-State Leakage	Package Type
		V_P	mA	Ω	mA	t_{on} / t_{off} ms	V_{rms}	μA	Page 119
CPC2014N	BI	60	400	2	2	2 / 1	1500	1	17
CPC2017N	BI	60	120	16	1	3 / 3	1500	1	17
CPC2025N	BI	400	120	30	2	2 / 1	1500	1	17
CPC2030N	BI	350	120	30	2	2 / 1	1500	1	17
LAA100	BI	350	120	25	5	5 / 5	3750	1	20, 21, 22
LAA100L	BI	350	120	25	5	5 / 5	3750	1	20, 21, 22
LAA108	BI	100	300	8	2	3 / 3	3750	1	20, 21, 22
LAA110	BI	350	120	35	5	3 / 3	3750	1	20, 21, 22
LAA110L	BI	350	120	35	5	3 / 3	3750	1	20, 21, 22
LAA120	BI	250	170	20	5	5 / 5	3750	1	20, 21, 22
LAA120L	BI	250	150	25	5	5 / 5	3750	1	20, 21, 22
LAA125	BI	350	170	16	5	5 / 5	3750	1	20, 21, 22
LAA125L	BI	350	150	18	5	5 / 5	3750	1	20, 21, 22
LAA127	BI	250	200	10	5	5 / 5	3750	1	20, 21, 22
LAA127L	BI	250	170	10	5	5 / 5	3750	1	20, 21, 22
LAA710	BI	60	1000	0.5	10	2.5 / 0.25	3750	1	20, 22
OAA160	BI	250	50	100	6	0.125 / 0.125	3750	0.025	20, 21, 22
PAA110	BI	400	150	22	5	1 / 0.25	3750	1	20, 21, 22
PAA110L	BI	400	150	25	5	1 / 0.5	3750	1	20, 21, 22
PAA127	BI	280	200	10	3	0.5 / 0.5	3750	0.025	20, 21, 22
PAA132	BI	60	600	1	2	5 / 2	3750	1	20, 22
PAA140	BI	400	250	8	5	3 / 1	3750	1	20, 21, 22
PAA140L	BI	400	200	13	5	5 / 3	3750	1	20, 22
PAA150	BI	250	250	7	5	2.5 / 0.5	3750	1	20, 21, 22
PAA190	BI	400	150	22	5	1 / 0.5	5000	1	20, 22
PAA191	BI	400	250	8	5	3 / 1	5000	1	20, 22
PAA193	BI	600	100	50	5	5 / 5	5000	10	20, 22
XAA117	BI	60	150	16	1	5 / 5	3750	1	20, 21, 22
XAA170	BI	350	100	50	5	5 / 5	3750	1	20, 21, 22

1-Form-B Relays (Normally Closed)

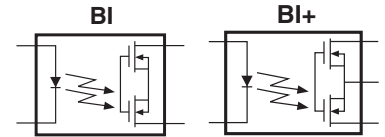

1-Form-B Relays: Single-Pole

Part Number	Relay Type	Blocking Voltage	Load Current	On Resistance	Input Control Current	Switching Speeds	Isolation Voltage	Off-State Leakage	Package Type
		V_P	mA	Ω	mA	t_{on} / t_{off} ms	V_{rms}	μA	Page 119
CPC1106N	BI	60	75	10	0.5	10 / 10	1500	1	10
CPC1114N	BI	60	400	2	2	2 / 5	1500	1	10
CPC1117N	BI	60	150	16	1	10 / 10	1500	1	10
CPC1125N	BI	400	100	35	2	2 / 2	1500	5	10
CPC1130N	BI	350	120	30	2	2 / 2	1500	5	10
CPC1135N	BI	350	120	35	2	2 / 2	1500	5	10
CPC1150N	BI	350	120	50	2	1 / 2	1500	5	10
CPC1231N	BI	350	120	30	2	2 / 2	1500	5	10
CPC1333	BI	350	130	30	2	2 / 3	5000	1	42, 43
LCB110	BI+	350	120	35	5	3 / 3	3750	1	12, 14
LCB111	BI+	350	120	35	2	5 / 5	3750	1	12, 14
LCB120	BI+	250	170	20	5	5 / 5	3750	1	12, 14
LCB126	BI+	250	170	15	5	5 / 5	3750	1	12, 14
LCB127	BI+	250	200	10	5	5 / 5	3750	1	12, 14
LCB710	BI+	60	1000	0.6	2	3 / 3	3750	1	12, 14
LCB716	BI+	60	500	2	2	3 / 3	3750	1	12, 14
LCB717	BI+	30	1500	0.3	2	2 / 5	3750	1	12, 14
PLB150	BI+	250	250	7	5	1 / 2.5	3750	1	12, 14
PLB171	BI	800	80	55	2	5 / 5	5000	1	62
PLB190	BI+	400	130	25	2	1 / 2.5	5000	1	12, 14
XCB170	BI+	350	100	50	5	5 / 5	3750	1	12, 14

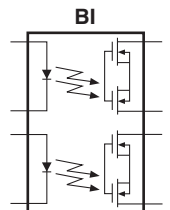

1-Form-B Relays: Dual Single-Pole

Part Number	Relay Type	Blocking Voltage	Load Current	On Resistance	Input Control Current	Switching Speeds	Isolation Voltage	Off-State Leakage	Package Type
		V_P	mA	Ω	mA	t_{on} / t_{off} ms	V_{rms}	μA	Page 119
CPC2125N	BI	400	100	35	2	2 / 2	1500	5	17
LBB110	BI	350	120	35	5	3 / 3	3750	1	20, 21, 22
LBB120	BI	250	170	20	5	5 / 5	3750	1	20, 22
LBB126	BI	250	170	15	5	5 / 5	3750	1	20, 21, 22
LBB127	BI	250	200	10	5	5 / 5	3750	1	20, 21, 22
PBB150	BI	250	250	7	5	2.5 / 2.5	3750	1	20, 21, 22
PBB190	BI	400	130	25	2	1 / 2.5	5000	1	20, 22
XBB170	BI	350	100	50	5	5 / 5	3750	1	20, 21, 22

Miscellaneous Relays

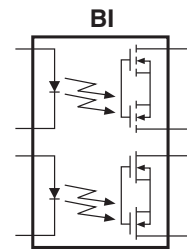

1-Form-A & 1-Form-B Combination Relays

Part Number	Relay Type	Blocking Voltage	Load Current	On Resistance	Input Control Current	Switching Speeds	Isolation Voltage	Off-State Leakage	Package Type
		V_P	mA	Ω	mA	t_{on} / t_{off} ms	V_{rms}	A/B μA	Page 119
CPC2317N	BI	60	120	16	1	3 / 3	1500	1 / 1	17
CPC2330N	BI	350	120	30	2	3 / 3	1500	1 / 5	17
LBA110	BI	350	120	35	2	3 / 3	3750	1 / 1	20, 21, 22
LBA110L	BI	350	120	35	5	3 / 3	3750	1 / 1	20, 21, 22
LBA120	BI	250	170	20	5	5 / 5	3750	1 / 1	20, 21, 22
LBA120L	BI	250	150	25	5	5 / 5	3750	1 / 1	20, 22
LBA127	BI	250	200	10	5	5 / 5	3750	1 / 1	20, 21, 22
LBA127L	BI	250	150	15	5	5 / 5	3750	1 / 1	20, 22
LBA710	BI	60	1000	0.6	2	5 / 5	3750	1 / 1	20, 22
LBA716	BI	60	1000	0.4	2	5 / 5	3750	1 / 1	20, 22
PBA150	BI	250	250	7	5	2.5 / 2.5	3750	1 / 1	20, 22

UNI

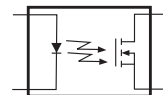

1-Form-A Relays: Single-Pole, Unidirectional (DC-only)

Part Number	Relay Type	Blocking Voltage	Load Current	On Resistance	Input Control Current	Switching Speeds	Isolation Voltage	Off-State Leakage	Package Type
		V_P	mA	Ω	mA	t_{on} / t_{off} ms	V_{rms}	μA	Page 119
CPC1002N	UNI	60	700	0.55	2	5 / 2	1500	1	10
CPC1004N	UNI	100	300	4	2	3 / 1	1500	1	10

BI

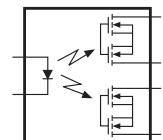

2-Form-A Relays: Double-Pole, Single-Throw

Part Number	Relay Type	Blocking Voltage	Load Current	On Resistance	Input Control Current	Switching Speeds	Isolation Voltage	Off-State Leakage	Package Type
		V_P	mA	Ω	mA	t_{on} / t_{off} ms	V_{rms}	μA	Page 119
LCA210	BI	350	85	35	8	3 / 3	3750	1	20, 22
LCA210L	BI	350	85	35	8	4 / 4	3750	1	20, 22
LCA220	BI	250	120	20	10	5 / 5	3750	1	20, 22

BI

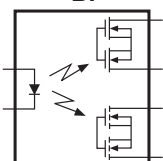

1-Form-C Relays: Common Input, Single-Pole, Double-Throw

Part Number	Relay Type	Blocking Voltage	Load Current	On Resistance	Input Control Current	Switching Speeds	Isolation Voltage	Off-State Leakage	Package Type
		V_P	mA	Ω	mA	t_{on} / t_{off} ms	V_{rms}	μA	Page 119
LCC110	BI	350	120	35	8	4 / 4	3750	1	20, 21, 22
LCC120	BI	250	170	20	10	5 / 5	3750	1	20, 22

Fault Protected Relays

Current Limiting SSRs with Voltage Triggered Shutdown & Thermal Management

- Active current-limiting circuitry
- Integrated thermal management (ThM)
- Voltage triggered shutdown (VTS)
- Provide excellent power-cross immunity
- Ideal for use in electromagnetically noisy environments
- Resumes normal operation after faults are removed

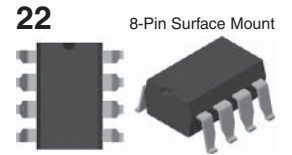
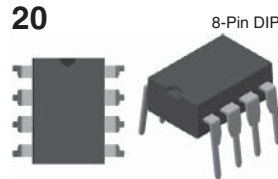
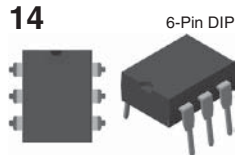
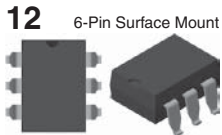
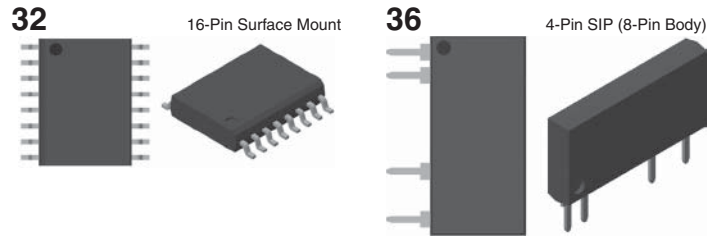

Part Number	Blocking Voltage (V_P)	Input Control Current (mA)	On-Resistance (Maximum)		Load Current (Maximum)		Current Limit (Maximum)		VTS ¹⁾ Threshold (V_{TH}) (V)	Switching Speed t_{on} / t_{off} (ms)	Isolation Voltage (V_{rms})	Package Type
			Configuration DC (Ω)	Configuration AC (Ω)	Configuration DC (mA)	Configuration AC (mA)	Configuration DC (mA _P)	Configuration AC (mA _P)				
➤ New CPC1510	250	2	3.75	15	350	200	920	450	-	2 / 2	3750	12, 14
CPC1511	230	2.5	-	4	-	450	-	1400	-	4 / 2	3750	12, 14
CPC1540	350	2	6.75	25	250	120	570	285	100 ¹⁾	2 / 2	3750	36
CPC1560	60	1.1	1.4	5.6	600	300	1500	900	-	0.1 / 0.4	3750	12, 14
➤ CPC1561	60	2.5	-	0.245	-	1000 ²⁾	-	3000	-	2.5 / 0.5	3750	32
CPC1563	600	2	11.75	35	250	120	570	285	100 ¹⁾	2 / 2	3750	12, 14
CPC1593	600	2	11.75	35	250	120	570	285	17.5 ¹⁾	2 / 2	3750	20, 22

¹⁾ Deactivates the switch when the load voltage exceeds the V_{TH} threshold while the switch is in current limit.

²⁾ Load current rating at up to 60°C

CPC1540, CPC1563, CPC1593

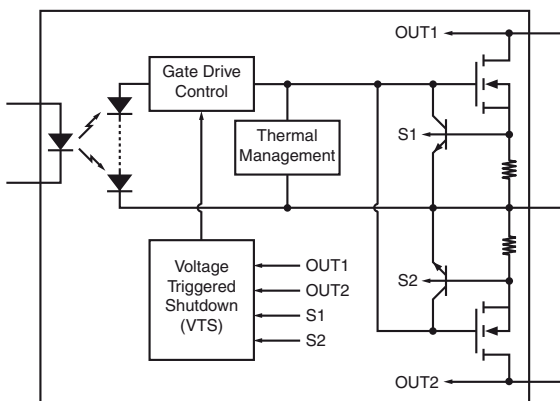

Applications:

- Telephony hook switch
- VoIP gateways
- I/O subsystems
- Electronic switching
- Medical equipment (patient/equipment isolation)
- Security
- Industrial controls

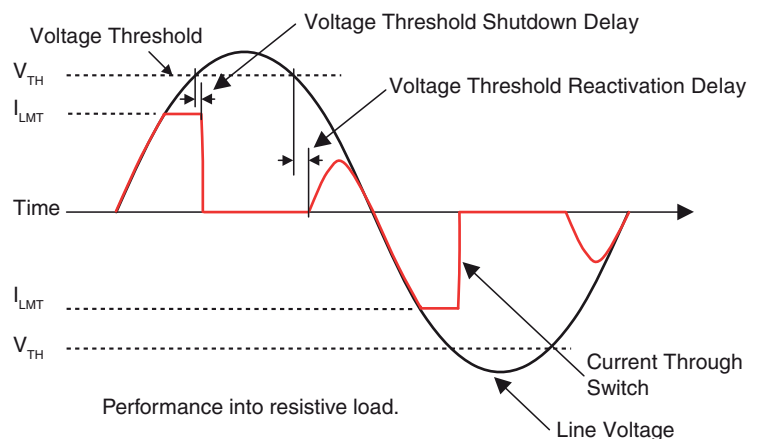

Power Relays

1-Form-A Power Relays: Single-Pole, Bidirectional

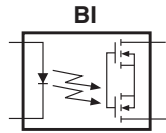

Part No.	Relay Type	Blocking Voltage V_P	Load Current			On Resistance Ω	Input Control Current mA	Switching Speeds t_{on} / t_{off} ms	Isolation Voltage V_{rms}	Off-State Leakage μA	Package Type
			Free Air A_{rms}	5°C/W Heat Sink A_{rms}	$T_C = 25^\circ C$ A_{rms}						
➤ New											
CPC1906Y	BI	60	2.00	-	-	0.30	10	10 / 5	2500	1	36
CPC1907B	BI	60	6.00	-	-	0.06	5	5 / 1	5000	1	66
CPC1908J	BI	60	3.50	8.50	15	0.30	10	20 / 5	2500	1	29
CPC1909J	BI	60	6.50	15	15	0.10	10	25 / 10	2500	1	37
CPC1916Y	BI	100	2.50	-	-	0.34	10	5 / 3	2500	1	36
CPC1918J	BI	100	5.25	13	15	0.10	10	25 / 10	2500	1	37
CPC1926Y	BI	250	0.70	-	-	1.40	10	10 / 10	2500	1	36
CPC1927J	BI	250	2.70	6.70	15	0.20	10	25 / 10	2500	1	37
CPC1967J	BI	400	1.35	3.35	13.15	0.85	10	20 / 5	2500	1	29
CPC1968J	BI	500	2.00	5	15	0.35	10	20 / 5	2500	1	37
CPC1973Y	BI	400	0.35	-	-	5	10	5 / 3	2500	1	36
CPC1977J	BI	600	1.25	3.10	12.25	1	10	20 / 5	2500	1	29
CPC1978J	BI	800	0.75	1.85	7.25	2.30	10	20 / 5	2500	1	29
CPC1979J	BI	600	1.40	3.50	14.50	0.75	10	25 / 5	2500	1	37
CPC1981Y	BI	1000	0.18	-	-	18	10	10 / 5	2500	1	36
CPC1983B	BI	600	0.50	-	-	6	5	5 / 2	5000	1	66
CPC1983Y	BI	600	0.50	-	-	6	5	5 / 2	2500	1	36
CPC1983YE	BI	600	0.50	-	-	6	5	5 / 2	4000	1	36
➤ CPC1984Y	BI	600	1	-	-	0.66	5	10 / 2	4000	1	36
CPC1986J	BI	1000	0.65	1.60	6.50	3	10	20 / 5	2500	1	29
CPC1988J	BI	1000	0.90	2.25	9.40	2.50	10	20 / 5	2500	1	37

Dual 1-Form-A Power Relay: Bidirectional

CPC2907B	BI	60	2	-	-	0.15	5	2.5/0.25	4000	1	66
----------	----	----	---	---	---	------	---	----------	------	---	----

1-Form-A Power Relays: Single-Pole, Unidirectional

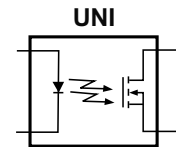

CPC1706Y	UNI	60	4	-	-	0.09	5	5 / 2	2500	1	36
CPC1708J	UNI	60	4	11.85	24	0.08	10	20 / 5	2500	1	29
CPC1709J	UNI	60	9	22.8	32	0.05	10	20 / 5	2500	1	37
CPC1718J	UNI	100	6.75	17.5	32	0.075	10	20 / 5	2500	1	37
CPC1726Y	UNI	250	1	-	-	0.75	10	5 / 2	2500	1	36
CPC1727J	UNI	250	3.4	8.6	20	0.09	10	20 / 5	2500	1	37
CPC1777J	UNI	600	1.5	4.6	15	0.5	10	20 / 5	2500	1	29
CPC1779J	UNI	600	1.65	4.12	15	0.4	10	20 / 5	2500	1	37
CPC1786J	UNI	1000	0.65	1.75	6.9	2	10	20 / 5	2500	1	29
CPC1788J	UNI	1000	1	2.45	10.3	1.25	10	20 / 5	2500	1	37

1-Form-B Power Relay: Single-Pole, Unidirectional

CPC1705Y	UNI	60	3.25	-	-	0.09	5	2 / 12	2500	1	36
----------	-----	----	------	---	---	------	---	--------	------	---	----

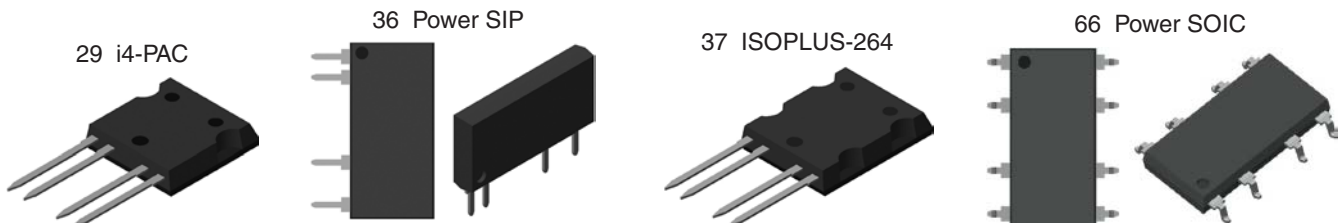

Optically Isolated AC Power Switches

The OptoMOS line of power products uses dual power-SCR outputs to produce an alternative to optocoupler and Triac circuits. These AC Power Switches provide a blocking voltage of up to $800V_p$. In addition, tightly controlled zero-cross circuitry ensures switching of AC loads while minimizing the generation of transients. The input and output circuits are optically coupled to provide $3750V_{rms}$ of isolation and noise immunity between control and load circuits. Long life and environmental integrity make these power switches ideal for controlling a variety of AC circuits in industrial environments where electromagnetic interference would disrupt the operation of electromechanical relays.

Optically Isolated AC Power Switches: $I_{LOAD} \leq 1A$

Part No.	Blocking Voltage V_p	Load Current A_{rms}	Input Control Current mA	Operating Frequency Range Hz	Isolation Voltage V_{rms}	Fig. No.
CPC1943	400	0.50	5	20 - 500	3750	15, 16
CPC1945G	400	1	5	20 - 400	3750	2
CPC1945Y	400	1	5	20 - 400	3750	23
CPC1961 Dual	600	0.25 ¹⁾	5	20 - 500	3750	20, 22
CPC1963	600	0.50	5	20 - 500	3750	15, 16
CPC1965G	600	1	5	20 - 400	3750	2
CPC1965Y	600	1	5	20 - 400	3750	23
CPC1972	800	0.25	5	20 - 500	3750	12, 14
PD1201	400	1	5	20 - 500	3750	2
PD2401	500	1	5	20 - 500	3750	2
PD2601	600	1	5	20 - 500	3750	2
PM1204	400	0.50	5	20 - 500	3750	15, 16
PM1205	500	0.50	5	20 - 500	3750	15, 16
PM1206	600	0.50	5	20 - 500	3750	15, 16
PS1201	400	1	5	20 - 500	3750	23
PS2401	500	1	5	20 - 500	3750	23
PS2601	600	1	5	20 - 500	3750	23

¹⁾ Maximum continuous load current of a single pole or the sum of the load currents with both poles operating simultaneously

2 4-Pin DIP (16-Pin Body)

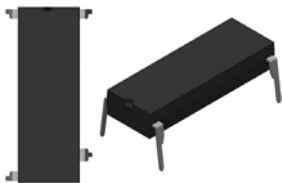

12 6-Pin Surface Mount



14 6-Pin DIP



15 6-Pin Power DIP



16 6-Pin Power DIP SMD



20 8-Pin DIP



22 8-Pin Surface Mount



23 4-Pin SIP (8-Pin Body)

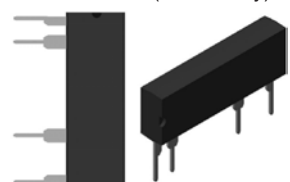

Optically Isolated AC Power Switches

Optically Isolated AC Power Switches: $I_{LOAD} > 1A$

Part No.	Blocking Voltage V_P	Load Current			Input Control Current mA	Operating Frequency Range Hz	Isolation Voltage V_{rms}	Fig. No.
		No Heat Sink A_{rms}	with 5°C/W Heat Sink A_{rms}	$T_C = 25^\circ C$ A_{rms}				
CPC1964B	800	1.5	-	-	5	20 - 500	5000	66
CPC1964BX6 ¹⁾	600	1.5	-	-	5	20 - 500	5000	66
CPC1966	600	3	-	-	5	20 - 500	3750	36
CPC1966B	800	3	-	-	5	20 - 500	5000	66
CPC1966BX8 ¹⁾	800	3	-	-	5	20 - 500	3750	66
CPC1966YX6 ¹⁾	600	3	-	-	5	20 - 500	3750	36
CPC1966YX8 ¹⁾	800	3	-	-	5	20 - 500	3750	36
CPC1976	600	2	-	-	5	20 - 500	3750	36
CPC1976YX6 ¹⁾	600	2	-	-	5	20 - 500	3750	36
CPC1998J	800	5	20	50	5	20 - 500	2500	29
CPC40055ST	800	5	20	40	5	20 - 500	2500	64

¹⁾ Rapid turn-on (non-zero-cross)

Rapid turn-on devices turn on when the control input goes true regardless of the load voltage phase, and turn off when the load current crosses zero.

29 i4-PAC

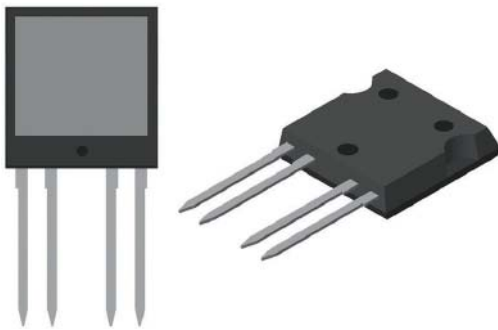

36 Power SIP

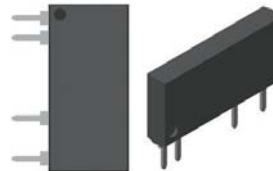

64 Super SIP

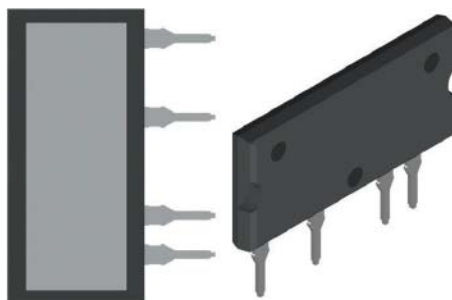

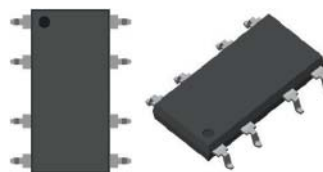

66 Power SOIC



IGBT & MOSFET Gate Drivers

Low-Side Gate Drivers

These ultra-fast, high current MOSFET and IGBT gate drivers are optimized for high efficiency performance in motor drive and power conversion applications. With output current ratings of 1.5A to 30A, they are designed to switch the largest MOSFETs and IGBTs with minimum switching times and at frequencies up to 10MHz.

Part No.	Output Type	I_{PEAK} $T_C = 25^\circ C$	Output Resistance	Logic Config.	Enable Function	Under-voltage Lockout	Fig. No.	Package Type
➤ New		A_p	Ω			V		
IX4426	DUAL	1.5	8.0	I	-	-	54, 56	20 8-Pin DIP Package Code: PI 
IX4427	DUAL	1.5	8.0	N	-	-	54, 56	
IX4428	DUAL	1.5	8.0	F	-	-	54, 56	
➤ IX4310T	SINGLE	2	3.0	D	-	4.2	52	52 SOT23-5 Package Code: R 
IXD_602	DUAL	2	4.0	F, I, N	-	-	20, 53, 54, 56	
IXD_604	DUAL	4	2.5	F, I, N, D	•	-	20, 53, 54, 56	
IX4340	DUAL	5	1.5	D	•	$V_{CC} \leq 3.8$	53, 54, 92	
IXD_609	SINGLE	9	1.0	I, N, D	•	-	20, 53, 54, 56, 57, 58	
IXD_614	SINGLE	14	0.8	I, N, D	•	-	20, 53, 57, 58	
IXD_630	SINGLE	30	0.4	I, N, D	•	$V_{CC} \leq 12.5$	57, 58	
IXD_630M	SINGLE	30	0.4	I, N, D	•	$V_{CC} \leq 9$	57, 58	

AEC-Q100 Qualified Low-Side Gate Drivers

Part No.	Output Type	I_{PEAK} $T_C = 25^\circ C$	Output Resistance	Logic Config.	Enable Function	Under-voltage Lockout	Fig. No.
➤ New		A_p	Ω			V	
IXD_604SI	DUAL	4	2.5	F, I, N, D	•		53
IXD_604SIA	DUAL	4	2.5	F, I, N, D	•		54
➤ IX4340NE	DUAL	5	1.5	D	•	$V_{CC} \leq 3.8$	53
IXD_609SI	SINGLE	9	1.0	I, N, D	•		53
IXD_614SI	SINGLE	14	0.8	I, N, D	•		53

Features:

- 1.5A to 30A Peak Source / Sink Drive Current
- Wide Operating Voltage Range
- -40°C to +125°C Extended Operating Temperature Range
- Logic Input Withstands Negative Swing of up to -5V
- Matched Rise and Fall Times
- Low Propagation Delay Time
- Low Output Impedance

Applications:

- Efficient Power MOSFET and IGBT Switching
- Switch Mode Power Supplies
- Motor Controls
- DC to DC Converters
- Class-D Switching Amplifiers
- Pulse Transformer Driver

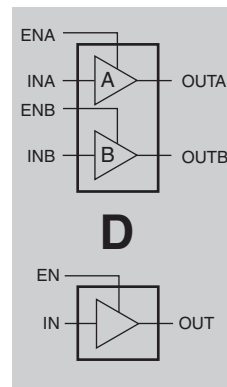
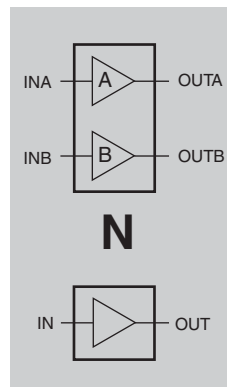
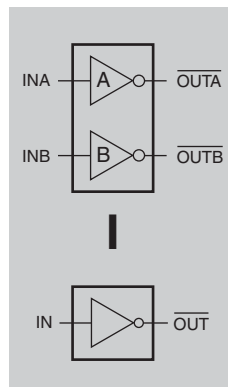
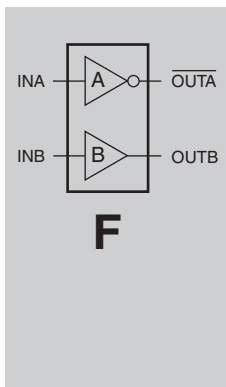

53 8-Pin Power SOIC
Package Code: SI



54 8-Pin SOIC
Package Code: SIA



56 8-Pin DFN
Package Code: D2



57 5-Pin TO-220
Package Code: CI

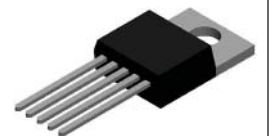

58 5-Pin TO-263
Package Code: YI



92 8-Pin MSOP



SiC Gate Driver

IX4351NE 9A Low-Side SiC MOSFET & IGBT Driver

NEW

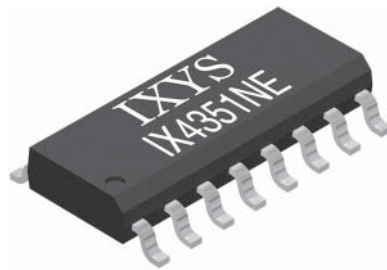
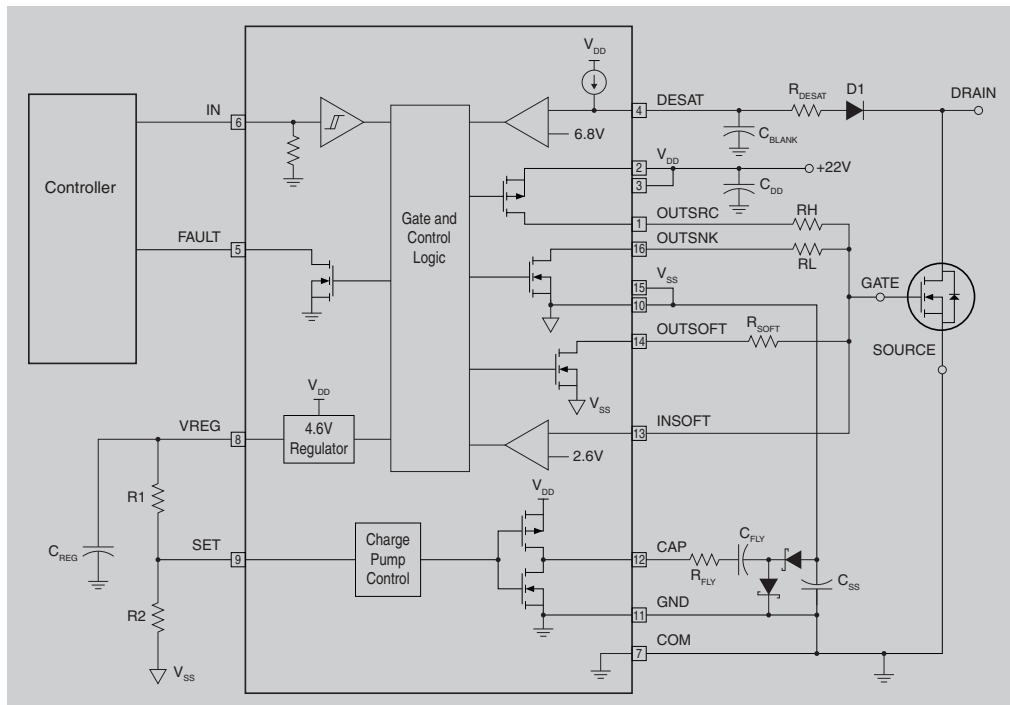

Features:

- Separate 9A peak source and sink outputs
- Operating voltage range: -10V to +25V
- Internal negative charge pump regulator for selectable negative gate drive bias
- Desaturation detection with soft shutdown sink driver
- TTL and CMOS compatible input
- Under Voltage lockout (UVLO)
- Thermal shutdown
- Open drain fault output

Applications:

- Driving SiC MOSFETs and IGBTs
- On-board charger and DC charging station
- Industrial inverters
- PFC, AC/DC and DC/DC converters

The IX4351NE is designed specifically to drive SiC MOSFETs and high power IGBTs. Separate 9A source and sink outputs allow for tailored turn-on and turn-off timing while minimizing switching losses. An internal negative charge regulator provides a selectable negative gate drive bias for improved dV/dt immunity and faster turn-off.

Desaturation detection circuitry detects an over current condition of the SiC MOSFET and initiates a soft turn off, thus preventing a potentially damaging dV/dt event. The logic input is TTL and CMOS compatible; this input does not need to be level shifted even with a negative gate drive bias voltage. Protection features include UVLO detection and thermal shutdown. An open drain FAULT output signals a fault condition to the microcontroller.

The IX4351NE is rated for operational temperature range of -40°C to $+125^{\circ}\text{C}$, and is available in a thermally enhanced 16-pin power SOIC package.

IGBT & MOSFET Gate Drivers

Optically Isolated Photovoltaic Gate Drivers

These Dual Optically Isolated Photodiode Arrays, which can produce an open-circuit voltage of up to 12V, are well suited for use in discrete solid state relay designs. The FDA215 and the FDA217 are available in 8-pin DIP and 8-pin surface-mount packages.

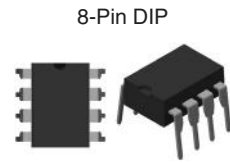
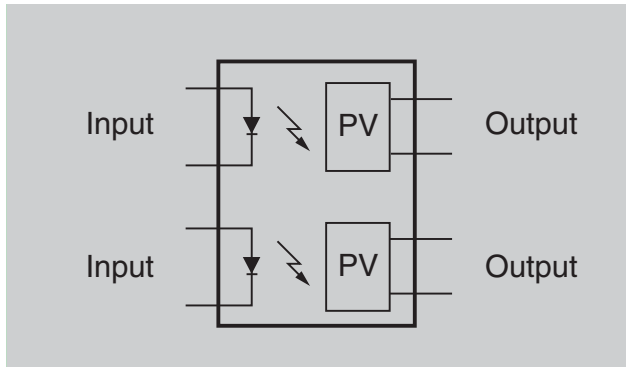

8-Pin Surface Mount

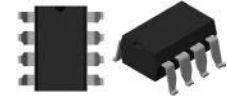

Features:

- Isolated 5.5V to 12V Photovoltaic Output
- Floating Outputs for Parallel or Series Configuration

Applications:

- MOSFET Driver
- Isolated Floating Power Source

Part No.	Input Control Current mA	Nominal Open-Circuit Voltage V_{OC} V	Nominal Short-Circuit Current I_{SC} μ A	Switching Speeds t_{on} / t_{off} ms	Isolation Voltage V_{rms}	Package Type
FDA215	5	5.5	2.5	5 / 5	3750	8-Pin DIP, 8-Pin Surface Mount
FDA217	5	11.75	4.5	2 / 0.5	3750	8-Pin DIP, 8-Pin Surface Mount

Optically Isolated Load-Biased Gate Drivers

The CPC1580 and CPC1590 are high speed, optically isolated Gate Driver ICs. On-chip circuitry charges an external capacitor from the load voltage which eliminates the need for an external IC power supply. These Gate Drivers are ideal for low duty cycle switching applications. Both devices are provided in an 8-pin flatpack package.

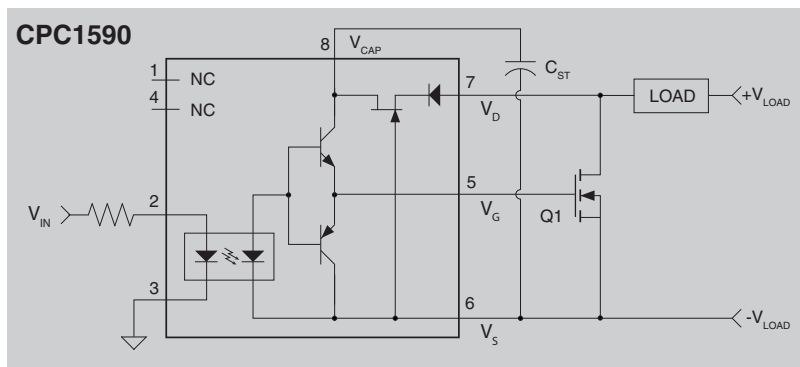

8-Pin Flatpack

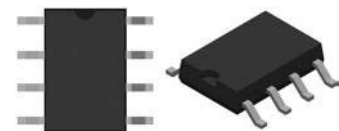

Features:

- No External IC Power Supply
- Low Drive Power Requirements (TTL/CMOS Compatible)
- Load Voltages up to 200V
- Fast Switching Speed - On: 40 μ s / Off: 400 μ s

Applications:

- Instrumentation
- Multiplexers
- I/O Subsystems
- Meters (Watt-Hour, Water, Gas)
- Medical Equipment (Patient / Equipment Isolation)
- Security
- Industrial Controls

Part No.	Input Control Current (mA)	Gate Voltage @ $I_F = 5$ mA (V_G)	Blocking Voltage (V_P)	Regulated Capacitor Voltage $V_{CAP(max)}$ (V)	Switching Speeds t_{on} / t_{off} (μ s)	Isolation Voltage (V_{rms})
CPC1580	2.5	7.5 - 12	65	$V_{DS} - 0.2$	40 / 400	3750
CPC1590	2.5	7.5 - 12	200	16	40 / 400	3750

IGBT & MOSFET Gate Drivers

CPC1596: 570V Optically Isolated Load-Biased Gate Driver

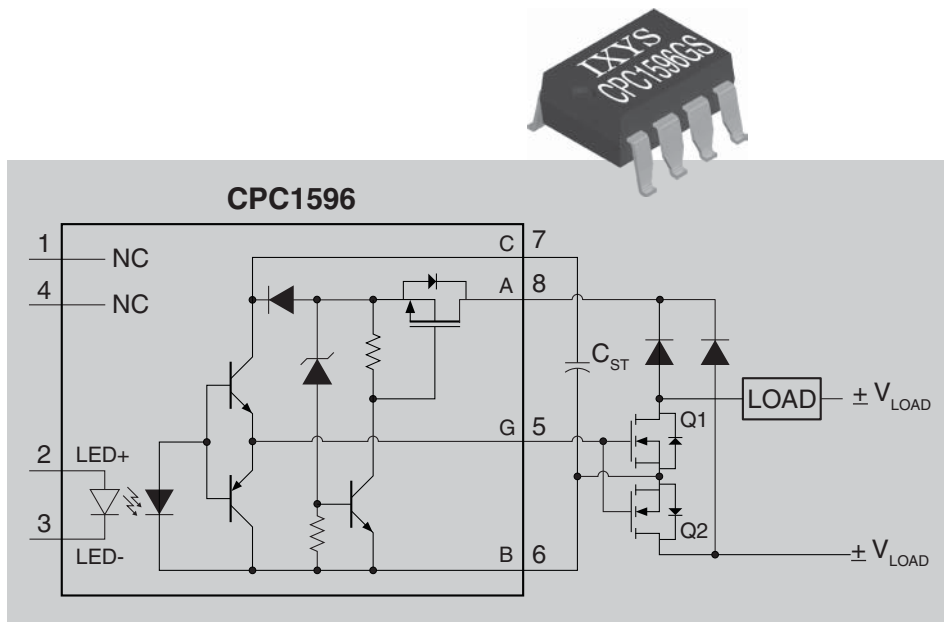

Features:

- Requires No Load-side Power Supply
- Drives External Power MOSFET
- Only 2.5mA Input LED Current to Drive External MOSFET
- 3750V_{rms} Input-to-Output Isolation

Applications:

- Optically Isolated AC or DC Relays for:
- Industrial Controls
 - Instrumentation
 - Medical Equipment Isolation
 - Electronic Switching
 - I/O Subsystems
 - Appliances

Linear Optocouplers

OptoMOS Linear Optocouplers feature an infrared LED optically coupled to a pair of photodiodes. The input photodiode is used to generate a feedback signal that provides a servomechanism to the LED drive current thus compensating for the LED's nonlinear characteristics. The output photodiode provides an isolated output signal that is linear with respect to the servo LED current.

Features:

- Couples Analog & Digital Signals
- 3750V_{rms} Input / Output Isolation
- Bandwidth >200kHz in Photoconductive Mode
- Bandwidth 40kHz in Photovoltaic Mode
- High Gain Stability
- Low Input / Output Capacitance
- Low Power Consumption
- 0.01% Servo Linearity
- THD 87dB Typical

Applications:

- Power Supply Feedback Voltage / Current
- Medical Sensor Interfacing
- Isolation of Process Control Transducers
- Isolated 4-20mA Converters

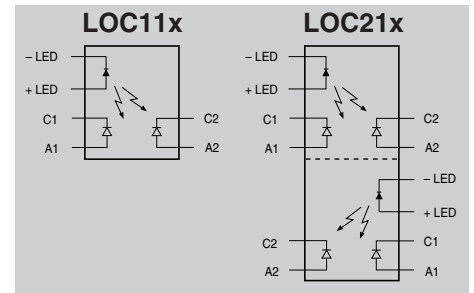

Part No.	Servo Gain $K_1 = I_1 / I_F$	Forward Gain $K_2 = I_2 / I_F$	Transfer Gain $K_3 = K_2 / K_1$	Input Control Current (mA)	Isolation Voltage (V _{rms})	Package Type
	Min / Max	Min / Max	Min / Max			
LOC110	0.004 / 0.03	0.004 / 0.03	0.668 / 1.179	2 - 10	3750	20, 21, 22
LOC111	0.008 / 0.03	0.006 / 0.03	0.733 / 1.072	2 - 10	3750	20, 21, 22
LOC112	0.004 / 0.03	0.004 / 0.03	0.733 / 1.072	2 - 10	3750	20, 21, 22
LOC117	0.008 / 0.03	0.006 / 0.03	0.887 / 1.072	2 - 10	3750	20, 21, 22
LOC210	0.004 / 0.03	0.004 / 0.03	0.773 / 1.072	2 - 10	3750	4
LOC211	0.008 / 0.03	0.006 / 0.03	0.773 / 1.072	2 - 10	3750	4



Two Fundamental Operating Configurations:

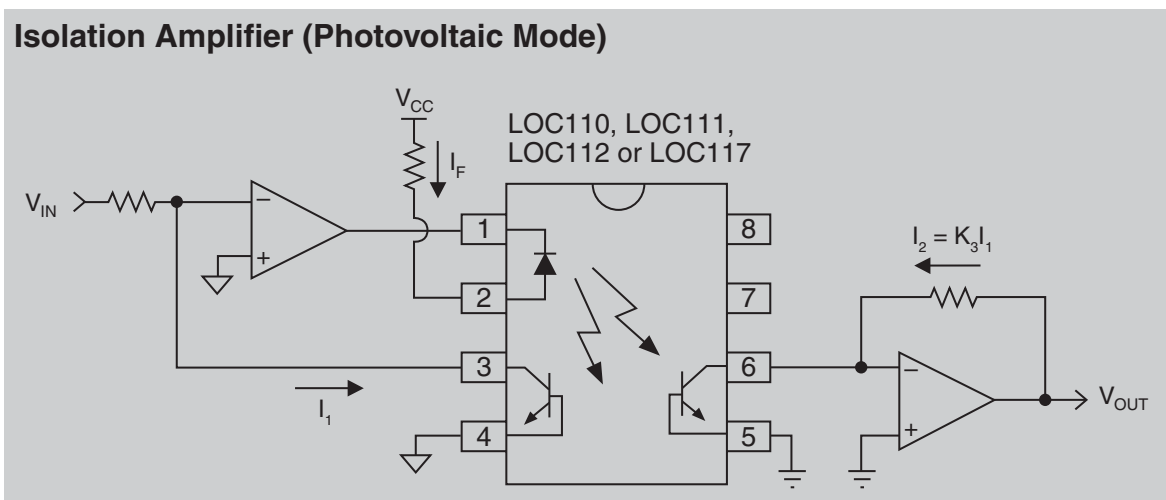

Photoconductive Mode:

- Wide Bandwidth (>200kHz)
- 8-bit Linearity

Photovoltaic Mode:

- 14-bit Linearity
- 40kHz Bandwidth

N-Channel Depletion Mode FETs

Our N-channel depletion mode Field Effect Transistors (FETs) utilize a proprietary third generation vertical DMOS process. The third generation process realizes world class, high voltage MOSFET performance in an economical silicon gate process. The vertical DMOS process yields a robust device for low-power applications with high input impedance. These highly reliable FET devices have been used extensively in our solid state relays for industrial and telecommunications applications. These normally on MOSFETs are well suited for low cost, pre-regulator applications that are tolerant of high voltage drop and power dissipation between the power source and the output regulator stage.

Part No.	$V_{(BR)DSX}$ (V)	$R_{DS(on)}$ Max (Ω)	$V_{GS(off)}$ Min (V)	$V_{GS(off)}$ Max (V)	$I_{DSS} @ V_{GS} = 0V$ Min (mA)	Package Type
CPC3701	60	1	-1.4	-3.1	600	SOT-89
CPC3703	250	4	-1.6	-3.9	360	SOT-89
CPC3708	350	14	-2.0	-3.6	130	SOT-89 / SOT-223
CPC3710	250	10	-1.6	-3.9	220	SOT-89
CPC3714	350	14	-1.6	-3.9	240	SOT-89
CPC3720	350	22	-1.6	-3.9	130	SOT-89
CPC3730	350	35	-1.6	-3.9	140	SOT-89
CPC3902	250	2.5	-1.4	-3.1	400	SOT-89 / SOT-223
CPC3909	400	6	-1.4	-3.1	300	SOT-89 / SOT-223
CPC3960	600	44	-1.4	-3.1	100	SOT-223
CPC3980	800	45	-1.4	-3.1	100	SOT-223
CPC3982	800	380	-1.4	-3.1	20	SOT-23

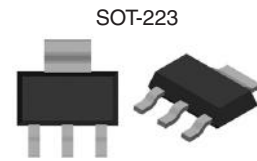
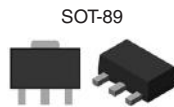
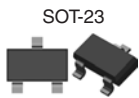

High Speed Digital Optical Isolators

Single-Chanel Each Direction Digital Optical Isolator: CPC5001

Logic level translation for levels as low as 2.7V or as high as 5.5V

Passes DC signals - no refresh clock needed

Features:

- Isolates one signal in each direction
- Operates from 2.7V to 5.5V
- Buffered inputs - no external LED drive required
- Hysteresis at inputs for noise rejection
- Slew-limited drivers reduce EMI
- 3750V_{rms} galvanic isolation from input to output
- Power down to Hi-Z does not load outputs
- 5 Mbaud data rate

Applications:

- Isolated signal monitoring and control
- Power-over-Ethernet, POE
- Power supply high-side interface
- Logic level translation
- Microprocessor system interface
- Inter integrated circuit (I²C) interface
- Serial peripheral interface
- Full duplex communication
- Isolated line receiver
- Isolated data acquisition systems

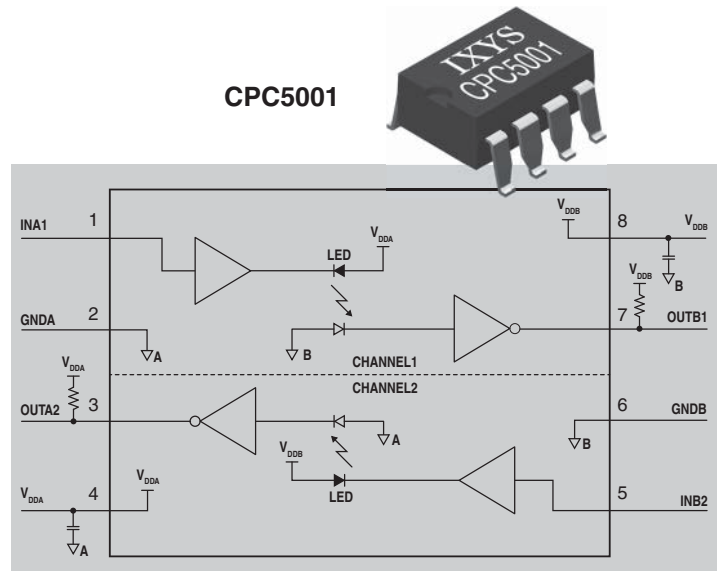

Dual Speed Digital Optical Isolator: CPC5002

3750V_{rms} galvanic isolation from input to output

Passes DC signals - no refresh clock needed

Features:

- Dual optics isolate two signals
- **10 Mbaud** data rate
- Operates over 2.7V < V_{DD} < 5.5V
- Power down to Hi-Z does not load outputs
- Low-power CMOS reduces supply current
- LED drive current only 1.5mA

Applications:

- Isolated line receiver
- Ground loop elimination
- ADC/DAC digital noise isolation
- 4-wire I²C bus isolation

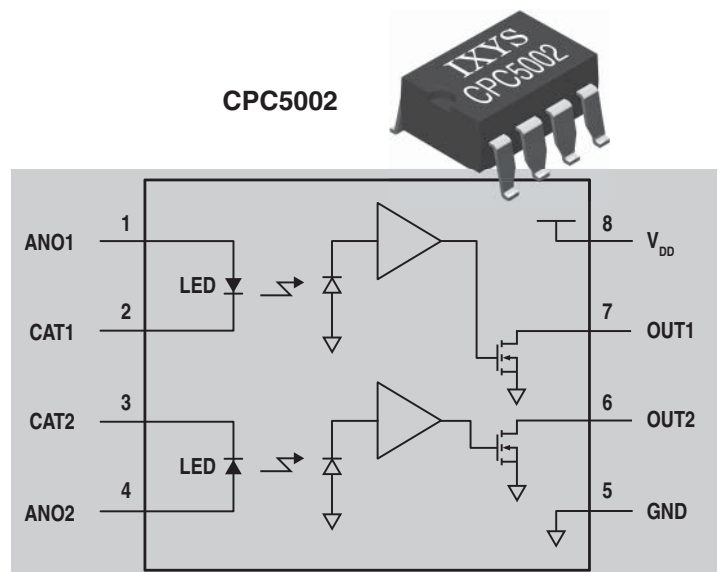

High Speed Digital Optical Isolators

Optically Isolated I²C Bus Repeaters: CPC5902 & CPC5903

- CPC5902 bidirectionally buffers clock and data signals
- CPC5903 bidirectionally buffers data signal, unidirectionally buffers clock signal
- Logic level translation for levels as low as 2.7V or as high as 5.5V
- Passes DC signals - no refresh clock needed - no clock noise generated

Applications:

- Power-over-Ethernet (POE)
- I²C bus length extender
- Isolated control and signal monitoring
- Power supply high-side interface
- I²C logic level translation

CPC5902

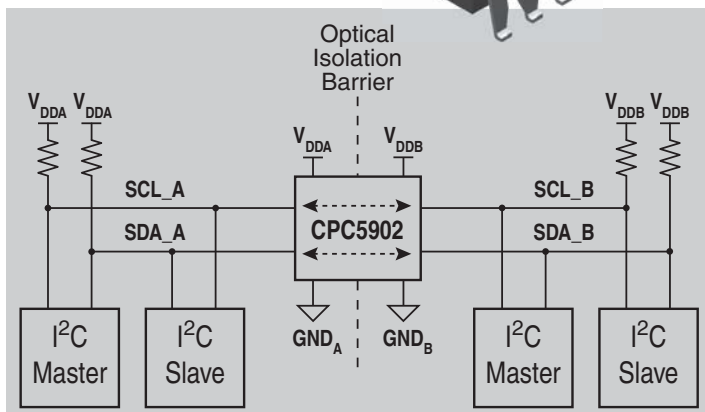

Features:

- Extends and isolates I²C interfaces
- Supports standard and fast mode I²C (400kbps)
- Side B fast-mode compliant: $V_{DDB} > 4.5V$
- Supports I²C clock stretching
- No internal clock - low EM & RF generation
- Operates on 2.7V to 5.5V
- Supports DC logic level buffering without refresh
- Glitch-free operation
- Power down to Hi-Z does not load I²C bus
- Slew-limited drivers reduce EMI
- Immune to external EMI & RF emissions
- High voltage isolation

CPC5903

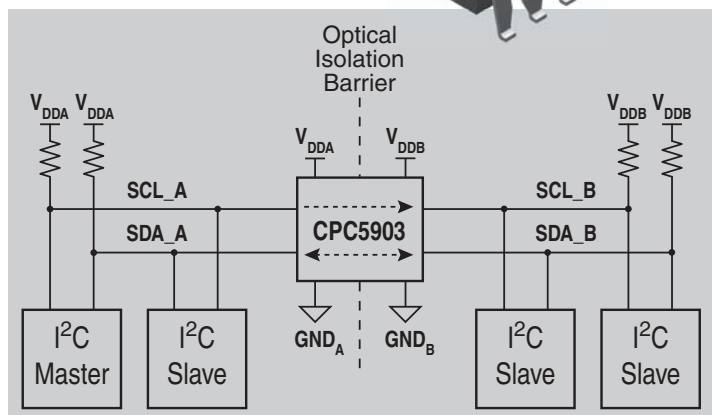
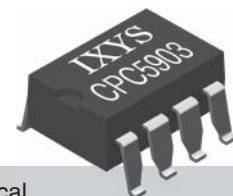

Features:

- Extends and isolates I²C interfaces
- Supports standard and fast mode I²C (400kbps)
- Side B fast-mode compliant: $V_{DDB} > 4.5V$
- No internal clock - low EM & RF generation
- Operates on 2.7V to 5.5V
- Supports DC logic level buffering without refresh
- Glitch-free operation
- Power down to Hi-Z does not load I²C bus
- Slew-limited drivers reduce EMI
- Immune to external EMI & RF emissions
- High voltage isolation

See Application Note TB-101 "Optically Isolating an I²C Interface"

- Use of a rectifier diode above T_{JMAX} with a short term overload
- Leakage current against temperature and applied voltage
- Setting disc spring type clamps
- Replacement of devices in assembly type XA3370ZX12WRs
- Possible failure modes in press-pack devices
- Recommended clamps for capsule semiconductors
- Guidance for soldering leads to thyristors, GTO thyristors and IGBT's
- Device mounting instruction
- Stocking & handling requirements for press-pack and module devices
- Recommended maximum force for module gate terminals
- Press releases
- Quality documents
- IXYS UK product nomenclatures
- An IGBT in DC Breaker application

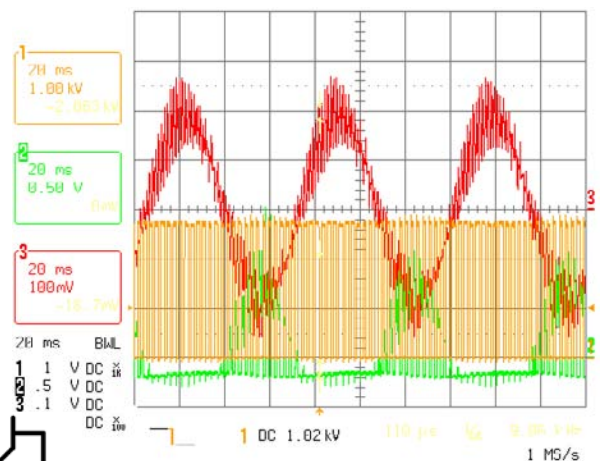
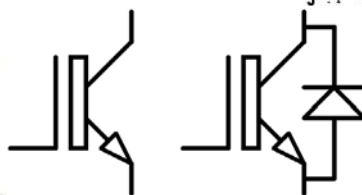
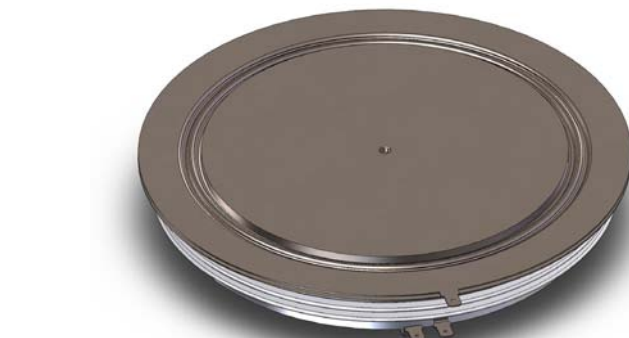





Rectifier Diodes

Our comprehensive range of rectifier diodes offers class leading performance and reliability. Devices are available with blocking voltages from 200V up to 7.2kV. Optimised to offer low conduction losses, these devices are ideally suited to line frequency applications up to 400Hz including input rectifiers for variable speed drives, traction converters, trackside substations, welding and DC power supplies. Featuring high temperature alloyed die construction, these devices offer low thermal impedance with high overload capacity and are designed to survive even the most arduous applications.

The latest additions to the IXYS UK Rectifier Diode family are the new 38mm and 50mm dia die Wespac Rectifier Diodes and the new 96mm large area rectifier diodes. These new designs are constructed using low temperature sintering technology and have an improved package design for maximum power to package ratio, as well as better thermal and electromechanical performance. The Wespac parts are available in current ratings up to 5332A and voltage ratings up to 3000V. The 96mm parts are available in current ratings up to 12100A and voltage ratings up to 6000V

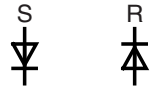
Also now available is a new 1263A rated M24 stud based assembly with voltage grades up to 2500V.

Stud Types

Part No.	V_{RRM}	I_{FAV}	I_{FSM}	I^2t	V_{TO}	r_T	T_{JM}	R_{thJC}		Fig. No.	Package style Outlines on pages O-01...O-35
	V	A	A	A ² s	V	mΩ	°C	d.c. 180° sine K/W	120° Rect. K/W		
W0428RE250	2500	428	5500	151 x 10 ³	0.926	0.739	150	0.1300	0.1530	W39	
W0428RE280	2800	428	5500	151 x 10 ³	0.926	0.739	150	0.1300	0.1530	W39	
W0428RE320	3200	428	5500	151 x 10 ³	0.926	0.739	150	0.1300	0.1530	W39	
W0428RF250	2500	428	5500	151 x 10 ³	0.926	0.739	150	0.1300	0.1530	W24	 W23 Weight 250 g
W0428RF280	2800	428	5500	151 x 10 ³	0.926	0.739	150	0.1300	0.1530	W24	
W0428RF320	3200	428	5500	151 x 10 ³	0.926	0.739	150	0.1300	0.1530	W24	
W0428SE250	2500	428	5500	151 x 10 ³	0.926	0.739	150	0.1300	0.1530	W39	
W0428SE280	2800	428	5500	151 x 10 ³	0.926	0.739	150	0.1300	0.1530	W39	
W0428SE320	3200	428	5500	151 x 10 ³	0.926	0.739	150	0.1300	0.1530	W39	
W0428SF250	2500	428	5500	151 x 10 ³	0.926	0.739	150	0.1300	0.1530	W24	
W0428SF280	2800	428	5500	151 x 10 ³	0.926	0.739	150	0.1300	0.1530	W24	
W0428SF320	3200	428	5500	151 x 10 ³	0.926	0.739	150	0.1300	0.1530	W24	
W0503RC160	1600	503	5500	151 x 10 ³	0.990	0.740	180	0.1300	0.1530	W24	 W24 Weight 250 g
W0503RC200	2000	503	5500	151 x 10 ³	0.990	0.740	180	0.1300	0.1530	W24	
W0503RC240	2400	503	5500	151 x 10 ³	0.990	0.740	180	0.1300	0.1530	W24	
W0503SC160	1600	503	5500	151 x 10 ³	0.990	0.740	180	0.1300	0.1530	W24	
W0503SC200	2000	503	5500	151 x 10 ³	0.990	0.740	180	0.1300	0.1530	W24	
W0503SC240	2400	503	5500	151 x 10 ³	0.990	0.740	180	0.1300	0.1530	W24	
W0735RA120	1200	735	9000	405 x 10 ³	0.790	0.342	190	0.1300	0.1530	W23	
W0735RA150	1500	735	9000	405 x 10 ³	0.790	0.342	190	0.1300	0.1530	W23	
W0735SA120	1200	735	9000	405 x 10 ³	0.790	0.342	190	0.1300	0.1530	W23	
W0735SA150	1500	735	9000	405 x 10 ³	0.790	0.342	190	0.1300	0.1530	W23	
W1263YC200KER	2000	675	11000	405 x 10 ³	0.870	0.330	175	0.1249	0.1359	W114	 W114 Weight 650 g
W1263YC250KER	2500	675	11000	405 x 10 ³	0.870	0.330	175	0.1249	0.1359	W114	
W1263YC200KES	2000	675	11000	405 x 10 ³	0.870	0.330	175	0.1249	0.1359	W114	
W1263YC250KES	2500	675	11000	405 x 10 ³	0.870	0.330	175	0.1249	0.1359	W114	
											 W39 Weight 250 g

Standard base clamp kits for rectifier diodes & phase control thyristors

These Single side cooled square base mounting clamps are suitable for 34 mm to 50 mm diameter electrode devices with clamping force in the range from 1130 Kgf to 2140 Kgf. Suitable for devices with blocking voltages from 400 volts up to 6 KV.

Part No.	Electrode Diameter	Outline
① XK1500CB034M	34-38	WC64
XK1130SB076M	34-38	WC65
XK2140SB076M	47-50	WC66

Standard part replacements to the obsolete flat-base power silicon diodes types KBN/R, KCN/R & KDN/R.
For other voltages and thyristor options please consult factory

Part No.	Old square base part no.	Base polarity	V _{RRM} V	I _{FAV} T _C = 100°C A	I _{FSM} kA	I ² t A ² s	V _T V	r _T mΩ	R _{th} K/W	Temp °C	Outlines see pages O-01...O-35
① W1185LC450KBR	SW45KBR515	Anode	4500	435	10.2	520 x 10 ³	1.000	0.575	0.085	160	WC64
① W1185LC450KBN	SW45KBN515	Cathode	4500	380	10.2	520 x 10 ³	1.000	0.575	0.101	160	WC64
① W1411LC360KBR	SW36KBR595	Anode	3600	505	12.2	744 x 10 ³	0.900	0.388	0.085	160	WC64
① W1411LC360KBN	SW36KBN595	Cathode	3600	445	12.2	744 x 10 ³	0.900	0.388	0.101	160	WC64
① W1524LC300KBR	SW30KBR636	Anode	3000	540	13.4	898 x 10 ³	0.870	0.323	0.085	160	WC64
① W1524LC300KBN	SW30KBN636	Cathode	3000	470	13.4	898 x 10 ³	0.870	0.323	0.101	160	WC64
① W1748LC220KBR	SW22KBR805	Anode	2200	660	13.5	911 x 10 ³	0.870	0.280	0.085	175	WC64
① W1748LC220KBN	SW22KBN805	Cathode	2200	582	13.5	911 x 10 ³	0.870	0.280	0.101	175	WC64
① W2058LC120KBR	SW12KBR935	Anode	1200	760	16.1	1.30 x 10 ⁶	0.790	0.192	0.085	175	WC64
① W2058LC120KBN	SW12KBN935	Cathode	1200	665	16.1	1.30 x 10 ⁶	0.790	0.192	0.101	175	WC64
W1185LC450KCR	SW45KBR515	Anode	4500	455	10.2	520 x 10 ³	1.000	0.575	0.080	160	WC65
W1185LC450KCN	SW45KBN515	Cathode	4500	395	10.2	520 x 10 ³	1.000	0.575	0.097	160	WC65
W1411LC360KCR	SW36KBR595	Anode	3600	530	13.2	756 x 10 ³	0.900	0.388	0.080	160	WC65
W1411LC360KCN	SW36KBN595	Cathode	3600	460	12.3	759 x 10 ³	0.900	0.388	0.097	160	WC65
W1524LC300KCR	SW30KBR635	Anode	3000	565	13.4	898 x 10 ³	0.870	0.323	0.080	160	WC65
W1524LC300KCN	SW30KBN636	Cathode	3000	490	13.4	898 x 10 ³	0.870	0.323	0.097	160	WC65
W1748LC220KCR	SW22KBR805	Anode	2200	690	13.5	911 x 10 ³	0.870	0.280	0.080	175	WC65
W1748LC220KCN	SW22KBN805	Cathode	2200	600	13.5	911 x 10 ³	0.870	0.280	0.097	175	WC65
W2058LC120KCR	SW12KBR935	Anode	1200	800	16.1	1.30 x 10 ⁶	0.790	0.192	0.080	175	WC65
W2058LC120KCN	SW12KBN935	Cathode	1200	690	16.1	1.30 x 10 ⁶	0.790	0.192	0.097	175	WC65
W3082MC450KDR	SB45KDR680	Anode	4500	1115	26.6	3.54 x 10 ⁶	0.923	0.192	0.037	160	WC66
W3082MC450KDN	SB45KDN680	Cathode	4500	1030	26.6	3.54 x 10 ⁶	0.923	0.192	0.041	160	WC66
W3708MC350KDR	SB35KDR820	Anode	3500	1240	33.7	5.68 x 10 ⁶	0.958	0.112	0.037	160	WC66
W3708MC350KDN	SB35KDN820	Cathode	3500	1145	33.7	5.68 x 10 ⁶	0.958	0.112	0.041	160	WC66
W3842MC280KDR	SB28KDR950	Anode	2800	1325	33.5	5.61 x 10 ⁶	0.831	0.118	0.037	160	WC66
W3842MC280KDN	SB28KDN950	Cathode	2800	1225	33.5	5.61 x 10 ⁶	0.831	0.118	0.041	160	WC66
W5636MC150KDR	SB15KDR14C	Anode	1500	2035	43.9	9.64 x 10 ⁶	0.698	0.059	0.037	175	WC66
W5636MC150KDN	SB15KDN14C	Cathode	1500	1875	43.9	9.64 x 10 ⁶	0.698	0.059	0.041	175	WC66

① = assembly supplied either as kit of parts or sub-assembly with selected diode or thyristor

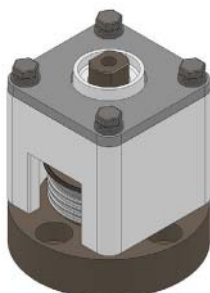

WC64

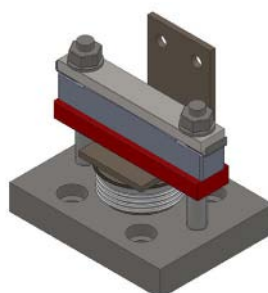



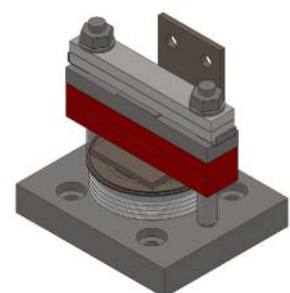



WC65



WC66











Rectifier Diodes

Capsule Types

Part No.	V_{RRM}	I_{FAV}	I_{FSM}	I_{t}	V_{TO}	r_T	T_{JM}	R_{thJK}		Fig. No.	Package style Outlines on pages O-01...O-35
	V	$T_K = 55^\circ C$ A	10 ms $\frac{1}{2}$ sine $V_R - \leq 60\% V_{RRM}$ A	A^2s	V	$m\Omega$	$^\circ C$	180° Sine K/W	120° Rect. K/W		
W0507YH420	4200	505	7600	289×10^3	0.970	0.880	160	0.1000	0.1170	W3	
W0507YH450	4500	505	7600	289×10^3	0.970	0.880	160	0.1000	0.1170	W3	
W0642WC160	1600	680	5500	151×10^3	1.070	0.676	190	0.0900	0.0980	W1	
W0642WC200	2000	680	5500	151×10^3	1.070	0.676	190	0.0900	0.0980	W1	
W0642WC240	2400	680	5500	151×10^3	1.070	0.676	190	0.0900	0.0980	W1	
W0790LG650	6500	790	6000	180×10^3	0.919	1.249	150	0.0394	0.0445	W120	W1 Weight 70 g
W0790LG720	7200	790	6000	180×10^3	0.919	1.249	150	0.0394	0.0445	W120	
W0880LC650	6500	880	6000	180×10^3	0.919	1.249	150	0.0330	0.0400	W4	
W0880LC720	7200	880	6000	180×10^3	0.919	1.249	150	0.0330	0.0400	W4	
W0925LG500	5000	925	7200	259×10^3	1.000	0.702	150	0.0394	0.0445	W120	
W0925LG560	5600	925	7200	259×10^3	1.000	0.702	150	0.0394	0.0445	W120	
W0925LG600	6000	925	7200	259×10^3	1.000	0.702	150	0.0394	0.0445	W120	
W0944WC120	1200	944	9000	405×10^3	0.790	0.342	190	0.0900	0.0980	W1	W2 Weight 80 g
W0944WC150	1500	944	9000	405×10^3	0.790	0.342	190	0.0900	0.0980	W1	
W1032LC500	5000	1032	7200	259×10^3	1.000	0.702	150	0.0330	0.0400	W4	
W1032LC560	5600	1032	7200	259×10^3	1.000	0.702	150	0.0330	0.0400	W4	
W1032LC600	6000	1032	7200	259×10^3	1.000	0.702	150	0.0330	0.0400	W4	
W1060LG420	4200	1060	9200	423×10^3	1.000	0.575	160	0.0394	0.0445	W120	
W1060LG450	4500	1060	9200	423×10^3	1.000	0.575	160	0.0394	0.0445	W120	
W1074YC200	2000	1074	10800	583×10^3	0.920	0.390	160	0.0500	0.0610	W2	W3 Weight 140 g
W1074YC260	2600	1074	10800	583×10^3	0.920	0.390	160	0.0500	0.0610	W2	
W1074YC320	3200	1074	10800	583×10^3	0.920	0.390	160	0.0500	0.0610	W2	
W1074YH200	2000	1074	10800	583×10^3	0.920	0.390	160	0.0500	0.0610	W3	
W1074YH260	2600	1074	10800	583×10^3	0.920	0.390	160	0.0500	0.0610	W3	
W1074YH320	3200	1074	10800	583×10^3	0.920	0.390	160	0.0500	0.0610	W3	
W1185LC420	4200	1185	9200	423×10^3	1.000	0.575	160	0.0330	0.0393	W4	
W1185LC450	4500	1185	9200	423×10^3	1.000	0.575	160	0.0330	0.0393	W4	
W1260LG320	3200	1260	10600	562×10^3	0.900	0.388	160	0.0394	0.0445	W120	W4 Weight 340 g
W1260LG360	3600	1260	10600	562×10^3	0.900	0.388	160	0.0394	0.0445	W120	
W1263YC160	1600	1263	11700	684×10^3	0.870	0.330	175	0.0500	0.0610	W2	
W1263YC220	2200	1263	11700	684×10^3	0.870	0.330	175	0.0500	0.0610	W2	
W1263YC250	2500	1263	11700	684×10^3	0.870	0.330	175	0.0500	0.0610	W2	
W1263YH160	1600	1263	11700	684×10^3	0.870	0.330	175	0.0500	0.0610	W3	
W1263YH200	2000	1263	11700	684×10^3	0.870	0.330	175	0.0500	0.0610	W3	
W1263YH250	2500	1263	11700	684×10^3	0.870	0.330	175	0.0500	0.0610	W3	
W1360LG240	2400	1360	12700	800×10^3	0.870	0.323	160	0.0394	0.0445	W120	W5 Weight 510 g
W1360LG300	3000	1360	12700	800×10^3	0.870	0.323	160	0.0394	0.0445	W120	
W1411LC320	3200	1411	10600	562×10^3	0.900	0.388	160	0.0330	0.0393	W4	
W1411LC360	3600	1411	10600	562×10^3	0.900	0.388	160	0.0330	0.0393	W4	
W1520NC500	5000	1478	12000	720×10^3	0.904	0.552	150	0.0220	0.0255	W5	
W1520NC600	6000	1478	12000	720×10^3	0.904	0.552	150	0.0220	0.0255	W5	
W1524LC240	2400	1524	12700	800×10^3	0.870	0.323	160	0.0330	0.0393	W4	
W1524LC300	3000	1524	12700	800×10^3	0.870	0.323	160	0.0330	0.0393	W4	
W1730JK240	2400	1730	12700	800×10^3	0.870	0.323	160	0.0270	0.0314	W113	W113 Weight 200 g
W1730JK280	2800	1730	12700	800×10^3	0.870	0.323	160	0.0270	0.0314	W113	







Rectifier Diodes

Capsule Types

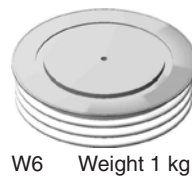
Part No. ○ Not for new design ➤ New	V _{RRM} V	I _{FAV} T _K = 55°C A	I _{FSM} 10 ms ½ sine V _R ≤ 60% V _{RRM} A	I ² t A ² s	V _{TO} V	r _T mΩ @ T _{JM}	T _{JM} °C	R _{th,jk}		Fig. No.	Package style Outlines on pages O-01...O-35
								180° Sine K/W	120° Rect. K/W		
W1748LC180	1800	1748	15400	118 x 10 ³	0.87	0.28	175	0.033	0.0393	W4	
W1748LC250	2500	1748	15400	118 x 10 ³	0.87	0.28	175	0.033	0.0393	W4	
W1856NC460	4600	1856	16000	128 x 10 ³	0.975	0.348	160	0.0220	0.0255	W5	
W1856NC480	4800	1856	16000	128 x 10 ³	0.975	0.348	160	0.0220	0.0255	W5	
W1975MC650	6500	1975	18000	1.62 x 10 ⁵	0.950	0.510	150	0.0140	0.0158	W54	
W1975MC680	6800	1975	18000	1.62 x 10 ⁵	0.950	0.510	150	0.0140	0.0158	W54	
W1975MC720	7200	1975	18000	1.62 x 10 ⁵	0.950	0.510	150	0.0140	0.0158	W54	
W1980JK180	1800	1980	15400	1.18 x 10 ⁶	0.870	0.280	175	0.0270	0.0314	W113	
W1980JK220	2200	1980	15400	1.18 x 10 ⁶	0.870	0.280	175	0.0270	0.0314	W113	
W2054NC420	4200	2054	19000	1.81 x 10 ⁶	0.800	0.300	160	0.0220	0.0274	W5	
W2054NC450	4500	2054	19000	1.81 x 10 ⁶	0.800	0.300	160	0.0220	0.0274	W5	
W2058LC100	1000	2058	19500	1.90 x 10 ⁶	0.790	0.192	175	0.0330	0.0393	W4	
W2058LC120	1200	2058	19500	1.90 x 10 ⁶	0.790	0.192	175	0.0330	0.0393	W4	
W2058LC140	1400	2058	19500	1.90 x 10 ⁶	0.790	0.192	175	0.0330	0.0393	W4	
W2115MC520	5200	2122	19000	1.81 x 10 ⁶	1.074	0.405	150	0.0140	0.0158	W54	
W2115MC560	5600	2122	19000	1.81 x 10 ⁶	1.074	0.405	150	0.0140	0.0158	W54	
W2115MC600	6000	2122	19000	1.81 x 10 ⁶	1.074	0.405	150	0.0140	0.0158	W54	
W2134NC360	3600	2134	20000	2.00 x 10 ⁶	0.865	0.260	160	0.0220	0.0255	W5	
W2134NC400	4000	2134	20000	2.00 x 10 ⁶	0.865	0.260	160	0.0220	0.0255	W5	
W2340JK120	1200	2340	19500	1.90 x 10 ⁶	0.790	0.192	175	0.0270	0.0314	W113	
W2340JK150	1500	2340	19500	1.90 x 10 ⁶	0.790	0.192	175	0.0270	0.0314	W113	
W2624NC240	2400	2624	28000	3.92 x 10 ⁶	0.780	0.160	160	0.0220	0.0255	W5	
W2624NC280	2800	2624	28000	3.92 x 10 ⁶	0.780	0.160	160	0.0220	0.0255	W5	
W2624ND240	2400	2624	28000	3.92 x 10 ⁶	0.780	0.160	160	0.0220	0.0255	W37	
W2624ND280	2800	2624	28000	3.92 x 10 ⁶	0.780	0.160	160	0.0220	0.0255	W37	
W2820VC420	4200	2820	26200	3.43 x 10 ⁶	1.300	0.147	160	0.0160	0.0190	W6	
W2820VC450	4500	2820	26200	3.43 x 10 ⁶	1.300	0.147	160	0.0160	0.0190	W6	
W2820VF420	4200	2820	26200	3.43 x 10 ⁶	1.300	0.147	160	0.0160	0.0190	W43	
W2820VF450	4500	2820	26200	3.43 x 10 ⁶	1.300	0.147	160	0.0160	0.0190	W43	
W2830HE520	5200	2830	32000	5.12 x 10 ⁶	0.910	0.260	150	0.0123	0.0133	W123	
W2830HE560	5600	2830	32000	5.12 x 10 ⁶	0.910	0.260	150	0.0123	0.0133	W123	
W2830HE600	6000	2830	32000	5.12 x 10 ⁶	0.910	0.260	150	0.0123	0.0133	W123	
➤ W2840QA180	1800	2840	20000	2.00 x 10 ⁶	0.940	0.139	180	0.0230	0.0255	W117	
➤ W2840QA220	2200	2840	20000	2.00 x 10 ⁶	0.940	0.139	180	0.0230	0.0255	W117	
➤ W2865HA680	6800	2862	32400	5.25 x 10 ⁶	0.982	0.308	150	0.0105	0.0116	W121	
➤ W2865HA720	7200	2862	32400	5.25 x 10 ⁶	0.982	0.308	150	0.0105	0.0116	W121	
W2899MC460	4600	2899	25400	3.23 x 10 ⁶	0.996	0.222	160	0.0140	0.0158	W54	
W2899MC480	4800	2899	25400	3.23 x 10 ⁶	0.996	0.222	160	0.0140	0.0158	W54	
W3082MC420	4200	3120	26000	3.38 x 10 ⁶	0.923	0.192	160	0.0140	0.0160	W54	
W3082MC450	4500	3120	26000	3.38 x 10 ⁶	0.923	0.192	160	0.0140	0.0160	W54	
W3090HA520	5200	3110	32000	5.12 x 10 ⁶	0.910	0.260	150	0.0105	0.0116	W121	
W3090HA560	5600	3110	32000	5.12 x 10 ⁶	0.910	0.260	150	0.0105	0.0116	W121	
W3090HA600	6000	3110	32000	5.12 x 10 ⁶	0.910	0.260	150	0.0105	0.0116	W121	
○ W3128VC360	3600	3128	30000	4.50 x 10 ⁶	0.875	0.158	160	0.0160	0.0190	W6	
○ W3128VC400	4000	3128	30000	4.50 x 10 ⁶	0.875	0.158	160	0.0160	0.0190	W6	
○ W3128VF360	3600	3128	30000	4.50 x 10 ⁶	0.875	0.158	160	0.0160	0.0190	W43	
○ W3128VF400	4000	3128	30000	4.50 x 10 ⁶	0.875	0.158	160	0.0160	0.0190	W43	





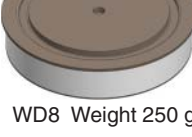









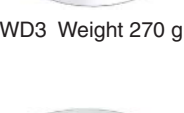

Rectifier Diodes

Capsule Types

Part No. ❖ Avalanche rated diode ○ Not for new design ➢ New	V_{RRM} V	I_{FAV} $T_K = 55^\circ\text{C}$ A	I_{FSM} A	I^2t 10 ms ½ sine $V_R \leq 60\% V_{RRM}$ A ² s	V_{TO} V	r_T @ T_{JM} mΩ	T_{JM} °C	R_{thJK}		Fig. No.	Package style Outlines on pages O-01...O-35
								180° Sine K/W	120° Rect. K/W		
❖ W3270NC20A	2000	3239	27600	3.81×10^6	0.818	0.108	175	0.0220	0.0255	W5	 W5 Weight 510 g
❖ W3270NC22A	2200	3239	27600	3.81×10^6	0.818	0.108	175	0.0220	0.0255	W5	
W3270NC180	2000	3270	28000	3.92×10^6	0.826	0.104	175	0.0220	0.0255	W5	
W3270NC220	2200	3270	28000	3.92×10^6	0.826	0.104	175	0.0220	0.0255	W5	
W3305QK240	2400	3305	18500	1.71×10^6	0.910	0.150	175	0.0170	0.0207	WD2	
W3305QK280	2800	3305	18500	1.71×10^6	0.910	0.150	175	0.0170	0.0207	WD2	
➢ W3409NK240	2400	3409	28000	3.92×10^6	0.780	0.160	160	0.0145	0.0171	WD8	 W6 Weight 1 kg
➢ W3409NK280	2800	3409	28000	3.92×10^6	0.780	0.160	160	0.0145	0.0171	WD8	
W3455QK200	2000	3455	20000	2.00×10^6	0.940	0.139	180	0.0170	0.0207	WD2	 W7 Weight 1.7 kg
W3455QK220	2200	3455	20000	2.00×10^6	0.940	0.139	180	0.0170	0.0207	WD2	
W3477MC360	3600	3470	28200	3.98×10^6	0.908	0.146	160	0.0140	0.0158	W54	 W8 Weight 1.2 kg
W3477MC400	4000	3470	28200	3.98×10^6	0.908	0.146	160	0.0140	0.0158	W54	
W3630TJ650	6500	3630	35000	6.125×10^6	0.916	0.262	150	0.0080	0.0085	W89	 W9 Weight 800 g
W3630TJ720	7200	3630	35000	6.125×10^6	0.916	0.262	150	0.0080	0.0085	W89	
W3630TE650	6500	3630	35000	6.125×10^6	0.916	0.262	150	0.0080	0.0085	W94	 W10 Weight 530 g
W3630TE720	7200	3630	35000	6.125×10^6	0.916	0.262	150	0.0080	0.0085	W94	
W3697VC220	2200	3697	40000	8.00×10^6	0.860	0.100	160	0.0160	0.0190	W6	 W11 Weight 1.3 kg
W3697VC280	2800	3697	40000	8.00×10^6	0.860	0.100	160	0.0160	0.0190	W6	
W3697VF220	2200	3697	40000	8.00×10^6	0.860	0.100	160	0.0160	0.0190	W43	 W12 Weight 1.6 kg
W3697VF280	2800	3697	40000	8.00×10^6	0.860	0.100	160	0.0160	0.0190	W43	
W3708MC320	3200	3753	30000	4.50×10^6	0.958	0.112	160	0.0140	0.0158	W54	 W13 Weight 250 g
W3708MC350	3500	3753	30000	4.50×10^6	0.958	0.112	160	0.0140	0.0158	W54	
○ W3743ZC400	4000	3750	35000	6.13×10^6	0.976	0.170	160	0.0110	0.0132	W7	
○ W3743ZC450	4500	3750	35000	6.13×10^6	0.976	0.170	160	0.0110	0.0132	W7	
○ W3743ZC500	5000	3750	35000	6.13×10^6	0.976	0.170	160	0.0110	0.0132	W7	
○ W3743ZD400	4000	3750	35000	6.13×10^6	0.976	0.170	160	0.0110	0.0132	W42	
○ W3743ZD450	4500	3750	35000	6.13×10^6	0.976	0.170	160	0.0110	0.0132	W42	
○ W3743ZD500	5000	3750	35000	6.13×10^6	0.976	0.170	160	0.0110	0.0132	W42	
W3841VC300	3000	3841	39800	7.92×10^6	0.860	0.115	175	0.0160	0.0190	W6	
W3841VC340	3400	3841	39800	7.92×10^6	0.860	0.115	175	0.0160	0.0190	W6	
W3841VF300	3000	3841	39800	7.92×10^6	0.860	0.115	175	0.0160	0.0190	W43	
W3841VF340	3400	3841	39800	7.92×10^6	0.860	0.115	175	0.0160	0.0190	W43	
W3842MC240	2400	3842	35100	$6.1^6 \times 10^6$	0.831	0.118	160	0.0140	0.0158	W54	
W3842MC280	2800	3842	35100	$6.1^6 \times 10^6$	0.831	0.118	160	0.0140	0.0158	W54	
❖ W3842MC28A	2800	3842	35100	$6.1^6 \times 10^6$	0.831	0.118	160	0.0140	0.0158	W54	
W3864QK120	1200	3864	22200	$2.4^6 \times 10^6$	0.861	0.109	180	0.0170	0.0210	WD2	
W3864QK150	1500	3864	22200	$2.4^6 \times 10^6$	0.861	0.109	180	0.0170	0.0210	WD2	
W3864QK180	1800	3864	22200	$2.4^6 \times 10^6$	0.861	0.109	180	0.0170	0.0210	WD2	
W4096ZC420	4200	4096	41700	8.70×10^6	0.730	0.158	160	0.0110	0.0132	W7	
W4096ZC450	4500	4096	41700	8.70×10^6	0.730	0.158	160	0.0110	0.0132	W7	
W4096ZD420	3400	4096	41700	8.70×10^6	0.730	0.158	160	0.0110	0.0132	W42	
W4096ZD450	4500	4096	41700	8.70×10^6	0.730	0.158	160	0.0110	0.0132	W42	
W4205TJ520	5200	4205	45000	10.1×10^6	0.850	0.190	150	0.0080	0.0085	W89	
W4205TJ560	5600	4205	45000	10.1×10^6	0.850	0.190	150	0.0080	0.0085	W89	
W4205TJ600	6000	4205	45000	10.1×10^6	0.850	0.190	150	0.0080	0.0085	W89	
W4205TE520	5200	4205	45000	10.1×10^6	0.850	0.190	150	0.0080	0.0085	W94	
W4205TE560	5600	4205	45000	10.1×10^6	0.850	0.190	150	0.0080	0.0085	W94	
W4205TE600	6000	4205	45000	10.1×10^6	0.850	0.190	150	0.0080	0.0085	W94	

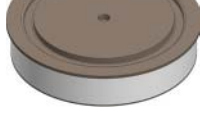





Rectifier Diodes

Capsule Types

Part No.	V_{RRM}	I_{FAV} $T_K = 55^\circ\text{C}$	I_{FSM} 10 ms $\frac{1}{2}$ sine $V_R \leq 60\% V_{RRM}$	I^2t A ² s	V_{T0}	r_T @ T_{JM}	T_{JM} °C	R_{thJK}		Fig. No.	Package style Outlines on pages O-01...O-35
								180° Sine K/W	120° Rect. K/W		
○ Not for new design ➤ New	V	A	A	A ² s	V	mΩ	°C	K/W	K/W		
➤ W4295NK200	2000	4295	28000	3.92×10^6	0.826	0.104	175	0.0145	0.0171	WD8	
➤ W4295NK220	2200	4295	28000	3.92×10^6	0.826	0.104	175	0.0145	0.0171	WD8	
W4534NC030	300	4534	40000	8.00×10^6	0.765	0.052	190	0.0220	0.0255	W5	
W4534NC060	600	4534	40000	8.00×10^6	0.765	0.052	190	0.0220	0.0255	W5	
➤ W4534ND030	300	4534	40000	8.00×10^6	0.765	0.052	190	0.0220	0.0255	W37	
➤ W4534ND060	600	4534	40000	8.00×10^6	0.765	0.052	190	0.0220	0.0255	W37	
➤ W4550HA360	3600	4550	35000	6.13×10^6	0.812	0.123	160	0.0105	0.0116	W121	WD2 Weight 200 g
➤ W4550HA400	4000	4550	35000	6.13×10^6	0.812	0.123	160	0.0150	0.0116	W121	
W4693QK050	500	4693	31500	4.98×10^6	0.904	0.057	180	0.0170	0.0207	WD2	
W4693QK080	800	4693	31500	4.98×10^6	0.904	0.057	180	0.0170	0.0207	WD2	
W4693QR050	500	4693	31500	4.98×10^6	0.904	0.057	180	0.0170	0.0207	WD7	
W4693QR080	800	4693	31500	4.98×10^6	0.904	0.057	180	0.0170	0.0207	WD7	
○ W4713HL300	3000	4713	56000	15.70×10^6	0.807	0.090	160	0.0120	0.0132	WD5	WD3 Weight 270 g
○ W4713HL350	3500	4713	56000	15.70×10^6	0.807	0.090	160	0.0120	0.0132	WD5	
○ W4713HM300	3000	4713	56000	15.70×10^6	0.807	0.090	160	0.0120	0.0132	WD6	
○ W4713HM350	3500	4713	56000	15.70×10^6	0.807	0.090	160	0.0120	0.0132	WD6	
W4767MC180	1800	4755	38000	7.22×10^6	0.827	0.083	175	0.0140	0.0158	W54	
W4767MC220	2200	4755	38000	7.22×10^6	0.827	0.083	175	0.0140	0.0158	W54	
W5092ZC320	3200	5092	58000	16.8×10^6	0.874	0.079	160	0.0110	0.0132	W7	WD5 Weight 1.2 kg
W5092ZC350	3500	5092	58000	16.8×10^6	0.874	0.079	160	0.0110	0.0132	W7	
W5092ZD320	3200	5092	58000	16.8×10^6	0.874	0.079	160	0.0110	0.0132	W42	
W5092ZD350	3500	5092	58000	16.8×10^6	0.874	0.079	160	0.0110	0.0132	W42	
W5130MK240	2400	5130	42000	8.82×10^6	0.910	0.070	175	0.0130	0.0149	WD3	
W5130MK280	2800	5130	42000	8.82×10^6	0.910	0.070	175	0.0130	0.0149	WD3	
W5139TJ450	4500	5139	55000	15.10×10^6	0.826	0.136	160	0.0080	0.0085	W89	WD6 Weight 1.5 kg
W5139TJ480	4800	5139	55000	15.10×10^6	0.826	0.136	160	0.0080	0.0085	W89	
W5139TE450	4500	5139	55000	15.10×10^6	0.826	0.136	160	0.0080	0.0085	W94	
W5139TE480	4800	5139	55000	15.10×10^6	0.826	0.136	160	0.0080	0.0085	W94	
W5282ZC240	2400	5282	60000	18.00×10^6	0.970	0.064	160	0.0110	0.0132	W7	
W5282ZC300	3000	5282	60000	18.00×10^6	0.970	0.064	160	0.0110	0.0132	W7	
W5282ZD240	2400	5282	60000	18.00×10^6	0.970	0.064	160	0.0110	0.0132	W42	
W5282ZD300	3000	5282	60000	18.00×10^6	0.970	0.064	160	0.0110	0.0132	W42	
W5334MK200	2000	5334	46800	10.95×10^6	0.892	0.069	180	0.0130	0.0149	WD3	WD7 Weight 200 g
W5334MK220	2200	5334	46800	10.95×10^6	0.892	0.069	180	0.0130	0.0149	WD3	
W5636MC120	1200	5636	46000	10.58×10^6	0.698	0.059	175	0.0140	0.0160	W54	
W5636MC150	1500	5636	46000	10.58×10^6	0.698	0.059	175	0.0140	0.0160	W54	
W5696VC100	1000	5696	53000	14.00×10^6	0.650	0.059	190	0.0160	0.0190	W6	
W5696VC140	1400	5696	53000	14.00×10^6	0.650	0.059	190	0.0160	0.0190	W6	
W5696VF100	1000	5696	53000	14.00×10^6	0.650	0.059	190	0.0160	0.0190	W43	WD8 Weight 250 g
W5696VF140	1400	5696	53000	14.00×10^6	0.650	0.059	190	0.0160	0.0190	W43	
W5715ED520	5200	5715	60600	$18.3^6 \times 10^6$	0.863	0.135	150	0.0060	0.0063	W112	
W5715ED560	5600	5715	60600	$18.3^6 \times 10^6$	0.863	0.135	150	0.0060	0.0063	W112	
W5715ED600	6000	5715	66000	$18.3^6 \times 10^6$	0.863	0.135	150	0.0060	0.0063	W112	
W5838ZC180	1800	5838	64000	20.50×10^6	0.800	0.074	175	0.0110	0.0132	W7	
W5838ZC220	2200	5838	64000	20.50×10^6	0.800	0.074	175	0.0110	0.0132	W7	
W5838ZD180	1800	5838	64000	20.50×10^6	0.800	0.074	175	0.0110	0.0132	W42	W112 Weight 2.1 kg
W5838ZD220	2200	5838	64000	20.50×10^6	0.800	0.074	175	0.0110	0.0132	W42	
W5984TJ360	3600	5984	62000	19.20×10^6	0.758	0.097	160	0.0080	0.0085	W89	
W5984TJ400	4000	5984	62000	19.20×10^6	0.758	0.097	160	0.0080	0.0085	W89	

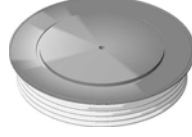
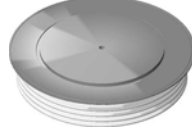
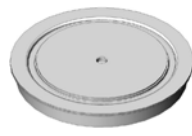
Rectifier Diodes

Capsule Types

Part No.	V_{RRM}	I_{FAV} $T_K = 55^\circ\text{C}$	I_{FSM} 10 ms $\frac{1}{2}$ sine $V_R \leq 60\% V_{RRM}$	I^2t A^2S	V_{TO} $@T_{JM}$	r_T $m\Omega$	T_{JM} $^\circ\text{C}$	R_{thJK}		Fig. No.	Package style Outlines on pages O-01...O-35
								180° Sine K/W	120° Rect. K/W		
➤ W5984TE360	3600	5984	62000	19.20×10^6	0.758	0.097	160	0.0080	0.0085	W94	
W5984TE400	4000	5984	62000	19.20×10^6	0.758	0.097	160	0.0080	0.0085	W94	
W6262ZC200	2000	6262	67000	22.40×10^6	0.730	0.064	175	0.0110	0.0132	W7	
W6262ZC240	2400	6262	67000	22.40×10^6	0.730	0.064	175	0.0110	0.0132	W7	
W6262ZD200	2000	6262	67000	22.40×10^6	0.730	0.064	175	0.0110	0.0132	W42	
W6262ZD240	2400	6262	67000	22.40×10^6	0.730	0.064	175	0.0110	0.0132	W42	
W6360EC520	5200	6360	60600	18.36×10^6	0.863	0.135	150	0.0050	0.0054	W111	W7 Weight 17 kg
W6360EC560	5600	6360	60600	18.36×10^6	0.863	0.135	150	0.0050	0.0054	W111	
W6360EC600	6000	6360	66000	18.36×10^6	0.863	0.135	150	0.0050	0.0054	W111	
W7032DB020	200	8690	49500	12.30×10^6	0.700	0.029	170	0.0100	0.0136	W49	
W7032DB040	400	8690	49500	12.30×10^6	0.700	0.029	170	0.0100	0.0136	W49	
W7045MC030	300	7045	54000	14.60×10^6	0.793	0.033	190	0.0140	0.0158	W54	
W7045MC060	600	7045	54000	14.60×10^6	0.793	0.033	190	0.0140	0.0158	W54	
➤ W8400ED320	3200	8400	83000	34.40×10^6	0.817	0.061	160	0.0060	0.0063	W112	W42 Weight 1.2 kg
➤ W8400ED350	3500	8400	83000	34.40×10^6	0.817	0.061	160	0.0060	0.0063	W112	
W8405ZC100	1000	8405	72000	25.90×10^6	0.670	0.038	190	0.0110	0.0132	W7	
W8405ZC140	1400	8405	72000	25.90×10^6	0.670	0.038	190	0.0110	0.0132	W7	
W8405ZD100	1000	8405	72000	25.90×10^6	0.670	0.038	190	0.0110	0.0132	W42	
W8405ZD140	1400	8405	72000	25.90×10^6	0.670	0.038	190	0.0110	0.0132	W42	
W8570TJ180	1800	8570	70200	24.60×10^6	0.690	0.050	175	0.0080	0.0085	W89	W49 Weight 120 g
W8570TJ220	2200	8570	70200	24.60×10^6	0.690	0.050	175	0.0080	0.0085	W89	
W8570TE180	1800	8570	70200	24.60×10^6	0.690	0.050	175	0.0080	0.0085	W94	
W8570TE220	2200	8570	70200	24.60×10^6	0.690	0.050	175	0.0080	0.0085	W94	
W9830TJ120	1200	9830	72000	25.90×10^6	0.670	0.043	190	0.0080	0.0085	W89	
W9830TJ150	1500	9830	72000	25.90×10^6	0.670	0.043	190	0.0080	0.0085	W89	
W9830TE120	1200	9830	72000	25.90×10^6	0.670	0.043	190	0.0080	0.0085	W94	
W9830TE150	1500	9830	72000	25.90×10^6	0.670	0.043	190	0.0080	0.0085	W94	
W106CEC240	2400	10650	92000	42.32×10^6	0.734	0.047	160	0.0050	0.0054	W111	W54 Weight 530 g
W106CEC280	2800	10650	92000	42.32×10^6	0.734	0.047	160	0.0050	0.0054	W111	
➤ W108CED180	1800	10815	94500	44.65×10^6	0.726	0.042	175	0.0060	0.0063	W112	
➤ W108CED220	2200	10815	94500	44.65×10^6	0.726	0.042	175	0.0060	0.0063	W112	
W121CEC180	1800	12100	94500	44.65×10^6	0.726	0.042	175	0.0050	0.0054	W111	
W121CEC220	2200	12100	94500	44.65×10^6	0.726	0.042	175	0.0050	0.0054	W111	











Fast Recovery Diodes

Fast Recovery Diodes are an essential complement to any switching device and are more often than not the limiting factor in the design and performance of modern power converters. To address the needs of our customers, we have developed an unparalleled range of Fast Recovery Diodes. These diodes are available with blocking voltages up to 6.5 kV making them suitable for operation with DC link voltages up to 3.3 kV and average current ratings to 4 kA depending upon type. The devices utilise both alloyed and floating silicon technologies to deliver robust devices that you can rely on in demanding applications. This range has been sub-classified as follows to aid appropriate device selection; Fast Recovery, Soft Recovery, Extra Fast Recovery Diodes and HP Sonic-FRDs.

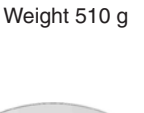
Standard Fast Recovery Capsule Types





These parts are particularly suitable for use as anti-parallel diodes in Gate Turn-Off thyristors and Fast Thyristor inverters, diodes for choppers.

Part No.	V _{RRM} V	I _{FAV} T _K = 55°C A	I _{FSM} A	I ² t 10 ms ½ sine V _R ≤ 60% V _{RRM} A ² s	Typ. Reverse Recovery T _J = 150°C				V _{T0} V	r _T mΩ	T _{JM} °C	R _{thJK} d.c. 180° sine K/W	Fig. No.	Package style Outlines on pages O-01...O-35
					t _{rr} µs	Q _{rr} µC	@ I _{FM} A	@ -di _e /dt A/µs						
M0588LC400	4000	588	3955	78.2 x 10 ³	3.50	450	1000	60	2.320	1.770	150	0.0330	W4	 W4
M0588LC450	4500	588	3955	78.2 x 10 ³	3.50	450	1000	60	2.320	1.770	150	0.0330	W4	
M0790YC200	2000	790	9000	405 x 10 ³	4.00	425	1000	60	1.272	0.584	150	0.0500	W2	 W2 Weight 80 g
M0790YC250	2500	790	9000	405 x 10 ³	4.00	425	1000	60	1.272	0.584	150	0.0500	W2	
M0790YH200	2000	790	9000	405 x 10 ³	4.00	425	1000	60	1.272	0.584	150	0.0500	W3	 W3
M0790YH250	2500	790	9000	405 x 10 ³	4.00	425	1000	60	1.272	0.584	150	0.0500	W3	
M0914LC200	2000	914	8500	361 x 10 ³	3.20	300	1000	60	1.768	0.653	150	0.0320	W4	 W4
M0914LC250	2500	914	8500	361 x 10 ³	3.20	300	1000	60	1.768	0.653	150	0.0320	W4	
M1010NC400	4000	1010	9600	461 x 10 ³	3.20	1450	1000	200	1.700	1.030	150	0.0220	W5	 W5
M1010NC450	4500	1010	9600	461 x 10 ³	3.20	1450	1000	200	1.700	1.030	150	0.0220	W5	
M1010ND400	4000	1010	9600	461 x 10 ³	3.20	1450	1000	200	1.700	1.030	150	0.0220	W37	 W37
M1010ND450	4500	1010	9600	461 x 10 ³	3.20	1450	1000	200	1.700	1.030	150	0.0220	W37	
M1163NC400	4000	1163	10800	583 x 10 ³	6.40	1200	1000	60	1.500	0.770	150	0.0220	W5	 W5
M1163NC450	4500	1163	10800	583 x 10 ³	6.40	1200	1000	60	1.500	0.770	150	0.0220	W5	
M1163ND400	4000	1163	10800	583 x 10 ³	6.40	1200	1000	60	1.500	0.770	150	0.0220	W37	 W37
M1163ND450	4500	1163	10800	583 x 10 ³	6.40	1200	1000	60	1.500	0.770	150	0.0220	W37	
M1502NC200	2000	1502	17000	1.45 x 10 ⁶	3.50	350	1000	60	1.240	0.440	150	0.0220	W5	 W5
M1502NC250	2500	1502	17000	1.45 x 10 ⁶	3.50	350	1000	60	1.240	0.440	150	0.0220	W5	
M1502ND200	2000	1502	17000	1.45 x 10 ⁶	3.50	350	1000	60	1.240	0.440	150	0.0220	W37	 W37
M1502ND250	2500	1502	17000	1.45 x 10 ⁶	3.50	350	1000	60	1.240	0.440	150	0.0220	W37	
M1583VC400	4000	1583	24800	3.08 x 10 ⁶	5.00	2000	1000	200	1.693	0.525	150	0.0160	W6	 W6
M1583VC450	4500	1583	24800	3.08 x 10 ⁶	5.00	2000	1000	200	1.693	0.525	150	0.0160	W6	
M1583VF400	4000	1583	24800	3.08 x 10 ⁶	5.00	2000	1000	200	1.693	0.525	150	0.0160	W43	 W43
M1583VF450	4500	1583	24800	3.08 x 10 ⁶	5.00	2000	1000	200	1.693	0.525	150	0.0160	W43	
M1609NC200	2000	1609	17500	1.53 x 10 ⁶	3.20	800	1000	200	1.310	0.345	150	0.0220	W5	 W5
M1609NC260	2600	1609	17500	1.53 x 10 ⁶	3.20	800	1000	200	1.310	0.345	150	0.0220	W5	
M1609ND200	2000	1609	17500	1.53 x 10 ⁶	3.20	800	1000	200	1.310	0.345	150	0.0220	W37	 W37
M1609ND260	2600	1609	17500	1.53 x 10 ⁶	3.20	800	1000	200	1.310	0.345	150	0.0220	W37	
M2273VC300	3000	2273	28000	3.92 x 10 ⁶	8.50	2500	1000	60	1.239	0.244	150	0.0160	W6	 W6
M2273VC360	3600	2273	28000	3.92 x 10 ⁶	8.50	2500	1000	60	1.239	0.244	150	0.0160	W6	
M2273VF300	3000	2273	28000	3.92 x 10 ⁶	8.50	2500	1000	60	1.239	0.244	150	0.0160	W43	 W43
M2273VF360	3600	2273	28000	3.92 x 10 ⁶	8.50	2500	1000	60	1.239	0.244	150	0.0160	W43	
M2325HA400	4000	2325	28000	3.92 x 10 ⁶	5.40	2300	1000	200	1.581	0.402	150	0.0105	W121	 W121
M2325HA450	4500	2325	28000	3.92 x 10 ⁶	5.40	2300	1000	200	1.581	0.402	150	0.0105	W121	

Fast Recovery Diodes

Standard Fast Recovery Capsule Types

These parts are particularly suitable for use as anti-parallel diodes in Gate Turn-Off thyristors and Fast Thyristor inverters, diodes for choppers.

Part No.	V _{RRM}	I _{FAV} T _K = 55°C	I _{FSM}	I ² t 10 ms ½ sine V _R - ≤ 60% V _{RRM}	Typ. Reverse Recovery T _J = 150°C				V _{TO}	r _T @ T _{JM} = 150°C	T _{JM}	R _{thJK} d.c. 180° sine	Fig. No.	Package style Outlines on pages O-01...O-35
					t _{rr}	Q _{rr}	@ I _{FM}	@ -di _p /dt						
➤ M2408NC020	200	2408	24000	2.88 x 10 ⁶	1.90	250	1000	200	1.065	0.122	150	0.0220	W5	 W5 Weight 510 g
M2408NC060	600	2408	24000	2.88 x 10 ⁶	1.90	250	1000	200	1.065	0.122	150	0.0220	W5	
M2408ND020	200	2408	24000	2.88 x 10 ⁶	1.90	250	1000	200	1.065	0.122	150	0.0220	W37	
M2408ND060	600	2408	24000	2.88 x 10 ⁶	1.90	250	1000	200	1.065	0.122	150	0.0220	W37	
➤ M2505MC220	2200	2505	27000	3.65 x 10 ⁶	7.60	1950	2000	60	0.991	0.162	125	0.0140	W54	
➤ M2505MC250	2500	2505	27000	3.65 x 10 ⁶	7.60	1950	2000	60	0.991	0.162	125	0.0140	W54	
M2639ZC360	3600	2639	27520	3.79 x 10 ⁶	8.50	2300	1000	60	1.380	0.290	150	0.0110	W7	 W6 Weight 1 kg
M2639ZC420	4200	2639	27520	3.79 x 10 ⁶	8.50	2300	1000	60	1.380	0.290	150	0.0110	W7	
M2639ZD360	3600	2639	27520	3.79 x 10 ⁶	8.50	2300	1000	60	1.380	0.290	150	0.0110	W42	
M2639ZD420	4200	2639	27520	3.79 x 10 ⁶	8.50	2300	1000	60	1.380	0.290	150	0.0110	W42	
M2698ZC250	2500	2698	27800	3.86 x 10 ⁶	6.20	1200	1000	60	1.000	0.330	150	0.0110	W7	
M2698ZC280	2800	2698	27800	3.86 x 10 ⁶	6.20	1200	1000	60	1.000	0.330	150	0.0110	W7	
M2698ZC350	3500	2698	27800	3.86 x 10 ⁶	6.20	1200	1000	60	1.000	0.330	150	0.0110	W7	
M2698ZD250	2500	2698	27800	3.86 x 10 ⁶	6.20	1200	1000	60	1.000	0.330	150	0.0110	W42	 W7 Weight 17 kg
M2698ZD280	2800	2698	27800	3.86 x 10 ⁶	6.20	1200	1000	60	1.000	0.330	150	0.0110	W42	
M2698ZD350	3500	2698	27800	3.86 x 10 ⁶	6.20	1200	1000	60	1.000	0.330	150	0.0110	W42	
M2837VC180	1800	2837	31800	5.10 x 10 ⁶	7.00	2100	1000	60	0.900	0.170	150	0.0160	W6	
M2837VC250	2500	2837	31800	5.10 x 10 ⁶	7.00	2100	1000	60	0.900	0.170	150	0.0160	W6	
M2837VF180	1800	2837	31800	5.10 x 10 ⁶	7.00	2100	1000	60	0.900	0.170	150	0.0160	W43	
M2837VF250	2500	2837	31800	5.10 x 10 ⁶	7.00	2100	1000	60	0.900	0.170	150	0.0160	W43	
M3770ZC200	2000	3770	44000	9.68 x 10 ⁶	7.00	2000	1000	60	1.190	0.118	150	0.0110	W7	 W37 Weight 510 g
M3770ZC240	2400	3770	44000	9.68 x 10 ⁶	7.00	2000	1000	60	1.190	0.118	150	0.0110	W7	
M3770ZC300	3000	3770	44000	9.68 x 10 ⁶	7.00	2000	1000	60	1.190	0.118	150	0.0110	W7	
M3770ZD200	2000	3770	44000	9.68 x 10 ⁶	7.00	2000	1000	60	1.190	0.118	150	0.0110	W7	
M3770ZD240	2400	3770	44000	9.68 x 10 ⁶	7.00	2000	1000	60	1.190	0.118	150	0.0110	W42	
M3770ZD300	3000	3770	44000	9.68 x 10 ⁶	7.00	2000	1000	60	1.190	0.118	150	0.0110	W42	



W54 Weight 530 g

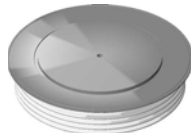

W42 Weight 1.2 kg

























W43 Weight 800 g













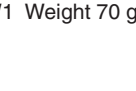

Soft Recovery Diodes

Our soft recovery diodes are available with a range of reverse recovery characteristics tailored to meet the requirements of both freewheeling and snubber applications. These devices are available with blocking voltages up to 6kV and average currents up to 2413A. 24mm to 75mm diameter silicon slices. These parts are particularly suitable where soft recovery is required, such as RCD snubbers, voltage clamping and snubberless applications.

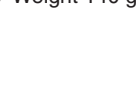
Stud Types

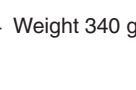













Part No.	V_{RRM} V	I_{FAV} A $T_C = 55^\circ\text{C}$	I_{FSM} A 10 ms $\frac{1}{2}$ sine $V_R - \leq 60\% V_{RRM}$	I^2t A ² s	Typ. Reverse Recovery				V_{TO} V @ T_{JM}	r_T mW @ T_{JM}	T_{JM} °C	R_{thJC} K/W d.c. 180° sine	Fig. No.	Package style Outlines on pages O-01...O-35
					t_{rr} µs	Q_{rr} µC	I_{FM} A @ T_{JM}	$-di_F/dt$ A/µs @ T_{JM}						
M0130RL200	2000	130	2240	25.0×10^3	2.60	430	1000	150	1.290	1.540	125	0.3000	W20	
M0130RL250	2500	130	2240	25.0×10^3	2.60	430	1000	150	1.290	1.540	125	0.3000	W20	
M0130SL200	2000	130	2240	25.0×10^3	2.60	430	1000	150	1.290	1.540	125	0.3000	W20	
M0130SL250	2500	130	2240	25.0×10^3	2.60	430	1000	150	1.290	1.540	125	0.3000	W20	
M0130RM200	2000	130	2240	25.0×10^3	2.60	430	1000	150	1.290	1.540	125	0.3000	W21	
M0130RM250	2500	130	2240	25.0×10^3	2.60	430	1000	150	1.290	1.540	125	0.3000	W21	
M0130SM200	2000	130	2240	25.0×10^3	2.60	430	1000	150	1.290	1.540	125	0.3000	W21	
M0130SM250	2500	130	2240	25.0×10^3	2.60	430	1000	150	1.290	1.540	125	0.3000	W21	
M0139RL120	1200	139	2450	30.0×10^3	1.00	125	1000	100	1.240	1.280	125	0.3000	W20	
M0139RL180	1800	139	2450	30.0×10^3	1.00	125	1000	100	1.240	1.280	125	0.3000	W20	
M0139SL120	1200	139	2450	30.0×10^3	1.00	125	1000	100	1.240	1.280	125	0.3000	W20	
M0139SL180	1800	139	2450	30.0×10^3	1.00	125	1000	100	1.240	1.280	125	0.3000	W20	
M0139RM120	1200	139	2450	30.0×10^3	1.00	125	1000	100	1.240	1.280	125	0.3000	W21	
M0139RM180	1800	139	2450	30.0×10^3	1.00	125	1000	100	1.240	1.280	125	0.3000	W21	
M0139SM120	1200	139	2450	30.0×10^3	1.00	125	1000	100	1.240	1.280	125	0.3000	W21	
M0139SM180	1800	139	2450	30.0×10^3	1.00	125	1000	100	1.240	1.280	125	0.3000	W21	
M0268RC200	2000	268	4250	90.3×10^3	2.80	300	1000	150	1.210	1.200	125	0.1300	W24	
M0268RC250	2500	268	4250	90.3×10^3	2.80	300	1000	150	1.210	1.200	125	0.1300	W24	
M0268SC200	2000	268	4250	90.3×10^3	2.80	300	1000	150	1.210	1.200	125	0.1300	W24	
M0268SC250	2500	268	4250	90.3×10^3	2.80	300	1000	150	1.210	1.200	125	0.1300	W24	
M0268RJ200	2000	268	4250	90.3×10^3	2.80	300	1000	150	1.210	1.200	125	0.1300	W22	
M0268RJ250	2500	268	4250	90.3×10^3	2.80	300	1000	150	1.210	1.200	125	0.1300	W22	
M0268SJ200	2000	268	4250	90.3×10^3	2.80	300	1000	150	1.210	1.200	125	0.1300	W22	
M0268SJ250	2500	268	4250	90.3×10^3	2.80	300	1000	150	1.210	1.200	125	0.1300	W22	
M0280RC200	2000	280	4500	100×10^3	2.80	610	1000	150	1.280	0.920	125	0.1300	W24	
M0280RC250	2500	280	4500	100×10^3	2.80	610	1000	150	1.280	0.920	125	0.1300	W24	
M0280SC200	2000	280	4500	100×10^3	2.80	610	1000	150	1.280	0.920	125	0.1300	W24	
M0280SC250	2500	280	4500	100×10^3	2.80	610	1000	150	1.280	0.920	125	0.1300	W24	
M0280RJ200	2000	280	4500	100×10^3	2.80	610	1000	150	1.280	0.920	125	0.1300	W22	
M0280RJ250	2500	280	4500	100×10^3	2.80	610	1000	150	1.280	0.920	125	0.1300	W22	
M0280SJ200	2000	280	4500	100×10^3	2.80	610	1000	150	1.280	0.920	125	0.1300	W22	
M0280SJ250	2500	280	4500	100×10^3	2.80	610	1000	150	1.280	0.920	125	0.1300	W22	
M0334RC120	1200	334	4500	101×10^3	3.50	160	550	40	1.000	0.740	125	0.1300	W24	
M0334RC200	2000	334	4500	101×10^3	3.50	160	550	40	1.000	0.740	125	0.1300	W24	
M0334SC120	1200	334	4500	101×10^3	3.50	160	550	40	1.000	0.740	125	0.1300	W24	
M0334SC200	2000	334	4500	101×10^3	3.50	160	550	40	1.000	0.740	125	0.1300	W24	
M0334RJ120	1200	334	4500	101×10^3	3.50	160	550	40	1.000	0.740	125	0.1300	W22	
M0334RJ200	2000	334	4500	101×10^3	3.50	160	550	40	1.000	0.740	125	0.1300	W22	
M0334SJ120	1200	334	4500	101×10^3	3.50	160	550	40	1.000	0.740	125	0.1300	W22	
M0334SJ200	2000	334	4500	101×10^3	3.50	160	550	40	1.000	0.740	125	0.1300	W22	
M0336RA120	1200	336	4500	101×10^3	3.00	140	550	40	1.020	0.700	125	0.1300	W23	
M0336RA140	1400	336	4500	101×10^3	3.00	140	550	40	1.020	0.700	125	0.1300	W23	
M0336SA120	1200	336	4500	101×10^3	3.00	140	550	40	1.020	0.700	125	0.1300	W23	
M0336SA140	1400	336	4500	101×10^3	3.00	140	550	40	1.020	0.700	125	0.1300	W23	

Capsule Types

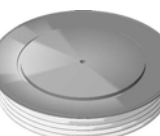
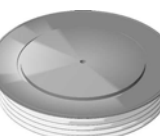
Part No.	V _{RRM} V	I _{FAV} T _K = 55°C A	I _{FSM} A	I _t A ² s	Typ. Reverse Recovery				V _{T0} V	r _T mΩ	T _{JM} °C	R _{thJK} d.c. 180° sine K/W	Fig. No.	Package style Outlines on pages O-01...O-35
					t _{rr} μs	Q _{rr} μC	@ I _{FM} A	@ -di _F / dt A/μs						
M0225YH300	3000	225	2000	20 x 10 ³	3.00	220	550	40	1.900	4.160	150	0.1000	W3	
M0225YH360	3600	225	2000	20 x 10 ³	3.00	220	550	40	1.900	4.160	150	0.1000	W3	
M0225YH450	4500	225	2000	20 x 10 ³	3.00	220	550	40	1.900	4.160	150	0.1000	W3	
M0310YH300	3000	310	4590	105 x 10 ³	2.80	275	1000	100	1.490	2.060	150	0.1000	W3	
M0310YH350	3500	310	4590	105 x 10 ³	2.80	275	1000	100	1.490	2.060	150	0.1000	W3	
M0347WC160	1600	347	4250	90.3 x 10 ³	2.80	210	550	40	1.210	1.200	125	0.0900	W1	
M0347WC200	2000	347	4250	90.3 x 10 ³	2.80	210	550	40	1.210	1.200	125	0.0900	W1	
M0347WC250	2500	347	4250	90.3 x 10 ³	2.80	210	550	40	1.210	1.200	125	0.0900	W1	
M0358WC120	1200	358	2450	30 x 10 ³	1.40	125	1000	100	1.460	0.800	125	0.0900	W1	
M0358WC180	1800	358	2450	30 x 10 ³	1.40	125	1000	100	1.460	0.800	125	0.0900	W1	
M0367WC140	1400	367	4500	101 x 10 ³	3.30	300	550	40	1.280	0.920	125	0.0900	W1	
M0367WC220	2200	367	4500	101 x 10 ³	3.30	300	550	40	1.280	0.920	125	0.0900	W1	
M0367WC280	2800	367	4500	101 x 10 ³	3.30	300	550	40	1.280	0.920	125	0.0900	W1	
M0371YH350	3500	371	4900	120 x 10 ³	3.20	1260	1000	200	1.050	1.650	150	0.1000	W3	
M0371YH450	4500	371	4900	120 x 10 ³	3.20	1260	1000	200	1.050	1.650	150	0.1000	W3	
M0433WC120	1200	433	4500	101 x 10 ³	3.50	270	550	40	1.000	0.740	125	0.0900	W1	
M0433WC160	1600	433	4500	101 x 10 ³	3.50	270	550	40	1.000	0.740	125	0.0900	W1	
M0433WC200	2000	433	4500	101 x 10 ³	3.50	270	550	40	1.000	0.740	125	0.0900	W1	
M0437WC080	800	437	4500	101 x 10 ³	3.00	75	550	40	1.020	0.700	125	0.0900	W1	
M0437WC140	1400	437	4500	101 x 10 ³	3.00	75	550	40	1.020	0.700	125	0.0900	W1	
M0451YC120	1200	451	4500	101 x 10 ³	2.80	120	550	40	1.000	0.740	125	0.0850	W2	
M0451YC160	1600	451	4500	101 x 10 ³	2.80	120	550	40	1.000	0.740	125	0.0850	W2	
M0451YC200	2000	451	4500	101 x 10 ³	2.80	120	550	40	1.000	0.740	125	0.0850	W2	
M0659LC400	4000	659	7620	290 x 10 ³	4.20	800	1000	60	1.710	0.925	125	0.0330	W4	
M0659LC450	4500	659	7620	290 x 10 ³	4.20	800	1000	60	1.710	0.925	125	0.0330	W4	
M0710LC560	5600	710	8400	353 x 10 ³	4.00	2100	1000	200	1.450	0.875	125	0.0330	W4	
M0710LC600	6000	710	8400	353 x 10 ³	4.00	2100	1000	200	1.450	0.875	125	0.0330	W4	
M0736LC400	4000	736	9000	405 x 10 ³	5.20	1250	1000	60	1.606	0.700	125	0.0330	W4	
M0736LC450	4500	736	9000	405 x 10 ³	5.20	1250	1000	60	1.606	0.700	125	0.0330	W4	
M0759YC120	1200	759	9500	450 x 10 ³	2.00	80	550	50	1.130	0.380	125	0.0500	W2	
M0759YC160	1600	759	9500	450 x 10 ³	2.00	80	550	50	1.130	0.380	125	0.0500	W2	
M0759YH120	1200	759	9500	450 x 10 ³	2.00	80	550	50	1.130	0.380	125	0.0500	W3	
M0759YH160	1600	759	9500	450 x 10 ³	2.00	80	550	50	1.130	0.380	125	0.0500	W3	
M0859LC140	1400	859	10000	500 x 10 ³	3.00	280	800	50	1.170	0.320	125	0.0440	W4	
M0859LC160	1600	859	10000	500 x 10 ³	3.00	280	800	50	1.170	0.320	125	0.0440	W4	
M0859LC180	1800	859	10000	500 x 10 ³	3.00	280	800	50	1.170	0.320	125	0.0440	W4	
M0863LC260	2600	863	10000	500 x 10 ³	4.80	950	1000	60	1.308	0.538	125	0.0330	W4	
M0863LC300	3000	863	10000	500 x 10 ³	4.80	950	1000	60	1.308	0.538	125	0.0330	W4	
M0863LC360	3600	863	10000	500 x 10 ³	4.80	950	1000	60	1.308	0.538	125	0.0330	W4	
M0872LC140	1400	872	10000	500 x 10 ³	4.00	700	1000	60	1.090	0.340	125	0.0440	W4	
M0872LC180	1800	872	10000	500 x 10 ³	4.00	700	1000	60	1.090	0.340	125	0.0440	W4	
M0872LC210	2100	872	10000	500 x 10 ³	4.00	700	1000	60	1.090	0.340	125	0.0440	W4	
M0955LC200	2000	955	11700	684 x 10 ³	3.40	500	1000	60	1.440	0.330	125	0.0330	W4	
M0955LC250	2500	955	11700	684 x 10 ³	3.40	500	1000	60	1.440	0.330	125	0.0330	W4	
M0955JK200	2000	1105	11700	684 x 10 ³	3.40	500	1000	60	1.440	0.330	125	0.0270	W113	
M0955JK250	2500	1105	11700	684 x 10 ³	3.40	500	1000	60	1.440	0.330	125	0.0270	W113	

Soft Recovery Diodes

Capsule Types

Part No.	V _{RRM} V	I _{FAV} T _K = 55°C A	I _{FSM} A	I ² t 10 ms ½ sine V _R - ≤ 60% V _{RRM} A ² s	Typ. Reverse Recovery				V _{T0} V	r _T mΩ	T _{JM} °C	R _{thJK} d.c. 180° sine K/W	Fig. No.	Package style Outlines on pages O-01...O-35
					t _{rr} μs	Q _{rr} μC	@ I _{FM} A	@ -di _F / dt A/μs						
M1022LC120	1200	1022	14000	980 x 10 ³	3.00	375	1000	60	1.240	0.330	125	0.0330	W4	
M1022LC160	1600	1022	14000	980 x 10 ³	3.00	375	1000	60	1.240	0.330	125	0.0330	W4	
M1022LC200	2000	1022	14000	980 x 10 ³	3.00	375	1000	60	1.240	0.330	125	0.0330	W4	
M1080LC100	1000	1080	13500	910 x 10 ³	1.90	85	1000	60	1.125	0.314	125	0.0330	W4	
M1080LC120	1200	1080	13500	910 x 10 ³	1.90	85	1000	60	1.125	0.314	125	0.0330	W4	
M1102NC500	5000	1102	13000	845 x 10 ³	5.50	3300	1000	200	1.360	0.557	125	0.0220	W5	W4 Weight 340 g
M1102NC600	6000	1102	13000	845 x 10 ³	5.50	3300	1000	200	1.360	0.557	125	0.0220	W5	
M1102ND500	5000	1102	13000	845 x 10 ³	5.50	3300	1000	200	1.360	0.557	125	0.0220	W37	
M1102ND600	6000	1102	13000	845 x 10 ³	5.50	3300	1000	200	1.360	0.557	125	0.0220	W37	
M1104NC400	4000	1104	13000	845 x 10 ³	6.00	2100	1000	60	1.370	0.553	125	0.0220	W5	
M1104NC450	4500	1104	13000	845 x 10 ³	6.00	2100	1000	60	1.370	0.553	125	0.0220	W5	W5 Weight 510 g
M1104ND400	4000	1104	13000	845 x 10 ³	6.00	2100	1000	60	1.370	0.553	125	0.0220	W37	
M1104ND450	4500	1104	13000	845 x 10 ³	6.00	2100	1000	60	1.370	0.553	125	0.0220	W37	
M1242NC260	2600	1242	16400	1.34 x 10 ⁶	6.00	1500	1000	60	1.270	0.420	125	0.0220	W5	
M1242NC360	3600	1242	16400	1.34 x 10 ⁶	6.00	1500	1000	60	1.270	0.420	125	0.0220	W5	
M1242ND260	2600	1242	16400	1.34 x 10 ⁶	6.00	1500	1000	60	1.270	0.420	125	0.0220	W37	W6 Weight 1 kg
M1242ND360	3600	1242	16400	1.34 x 10 ⁶	6.00	1500	1000	60	1.270	0.420	125	0.0220	W37	
M1494NC160	1600	1494	19600	1.92 x 10 ⁶	3.90	815	1000	60	1.150	0.265	125	0.0220	W5	
M1494NC250	2500	1494	19600	1.92 x 10 ⁶	3.90	815	1000	60	1.150	0.265	125	0.0220	W5	
M1494ND160	1600	1494	19600	1.92 x 10 ⁶	3.90	815	1000	60	1.150	0.265	125	0.0220	W37	
M1494ND250	2500	1494	19600	1.92 x 10 ⁶	3.90	815	1000	60	1.150	0.265	125	0.0220	W37	W7 Weight 1.7 kg
M1494NK160	1600	1975	19600	1.92 x 10 ⁶	3.90	815	1000	60	1.150	0.265	125	0.0145	WD8	
M1494NK250	2500	1975	19600	1.92 x 10 ⁶	3.90	815	1000	60	1.150	0.265	125	0.0145	WD8	
M1565VC400	4000	1565	19700	1.94 x 10 ⁶	5.00	4000	1000	200	1.090	0.360	125	0.0180	W6	
M1565VC450	4500	1565	19700	1.94 x 10 ⁶	5.00	4000	1000	200	1.090	0.360	125	0.0180	W6	
M1565VF400	4000	1565	19700	1.94 x 10 ⁶	5.00	4000	1000	200	1.090	0.360	125	0.0180	W43	W37 Weight 510 g
M1565VF450	4500	1565	19700	1.94 x 10 ⁶	5.00	4000	1000	200	1.090	0.360	125	0.0180	W43	
M1858NC120	1200	1858	25000	3.25 x 10 ⁶	2.50	120	1000	60	1.127	0.127	125	0.0220	W5	
M1858NC160	1600	1858	25000	3.25 x 10 ⁶	2.50	120	1000	60	1.127	0.127	125	0.0220	W5	W42 Weight 1.2 kg
M1858ND120	1200	1858	25000	3.25 x 10 ⁶	2.50	120	1000	60	1.127	0.127	125	0.0220	W37	
M1858ND160	1600	1858	25000	3.25 x 10 ⁶	2.50	120	1000	60	1.127	0.127	125	0.0220	W37	
M2322ZC300	3000	2322	23000	2.64 x 10 ⁶	6.50	3200	1000	150	1.670	0.186	125	0.0110	W7	
M2322ZC400	4000	2322	23000	2.64 x 10 ⁶	6.50	3200	1000	150	1.670	0.186	125	0.0110	W7	
M2322ZD300	3000	2322	23000	2.64 x 10 ⁶	6.50	3200	1000	150	1.670	0.186	125	0.0110	W42	W43 Weight 800 g
M2322ZD400	4000	2322	23000	2.64 x 10 ⁶	6.50	3200	1000	150	1.670	0.186	125	0.0110	W42	
M2413VC200	2000	2413	32000	5.12 x 10 ⁶	5.00	2500	1000	200	1.090	0.121	125	0.0160	W6	
M2413VC250	2500	2413	32000	5.12 x 10 ⁶	5.00	2500	1000	200	1.090	0.121	125	0.0160	W6	
M2413VF200	2000	2413	32000	5.12 x 10 ⁶	5.00	2500	1000	200	1.090	0.121	125	0.0160	W43	
M2413VF250	2500	2413	32000	5.12 x 10 ⁶	5.00	2500	1000	200	1.090	0.121	125	0.0160	W43	W89 Weight 1.3 kg
M3560TJ420	4200	3560	36000	6.48 x 10 ⁶	7.00	4100	1000	150	1.253	0.137	125	0.0080	W89	
M3560TJ450	4500	3560	36000	6.48 x 10 ⁶	7.00	4100	1000	150	1.253	0.137	125	0.0080	W89	
M4305TJ240	2400	4305	49000	12.0 x 10 ⁶	5.00	2500	1000	150	1.104	0.087	125	0.0080	W89	
M4305TJ280	2800	4305	49000	12.0 x 10 ⁶	5.00	2500	1000	150	1.104	0.087	125	0.0080	W89	

Extra Fast Recovery Diodes

These products are designed to offer the lowest practical values of reverse recovery current whilst offering wide safe operating area and high di/dt capability required by modern switching components.

Capsule Types

Part No.	V _{RRM} V	I _{FAV} T _K = 55°C A	I _{FSM} A	I ² t 10 ms ½ sine V _R - ≤ 60% V _{RRM} A ² s	Typ. Reverse Recovery					V _{T0} V	r _T mΩ	T _{JM} °C	R _{thJK} d.c. 180° sine K/W	Fig. No.
					I _{rm} A	t _{rr} μs	Q _{rr} μC	@ I _{FM} A	@ -di _F /dt A/μs					
F0240YC250	2500	240	3100	48.1 x 10 ³	40	2.00	100	550	40	2.271	2.853	150	0.1000	W2
F0240YC300	3000	240	3100	48.1 x 10 ³	40	2.00	100	550	40	2.271	2.853	150	0.1000	W2
F0240YH250	2500	240	3100	48.1 x 10 ³	40	2.00	100	550	40	2.271	2.853	150	0.1000	W3
F0240YH300	3000	240	3100	48.1 x 10 ³	40	2.00	100	550	40	2.271	2.853	150	0.1000	W3
F0300WC140	1400	240	2700	36.5 x 10 ³	530	3.00	70	550	40	1.760	2.210	125	0.0950	W1
F0300WC180	1800	240	2700	36.5 x 10 ³	530	3.00	70	550	40	1.760	2.210	125	0.0950	W1
F0800LC140	1400	775	7630	291 x 10 ³	380	1.10	200	1000	200	1.494	0.692	125	0.0320	W4
F0800LC180	1800	775	7630	291 x 10 ³	380	1.10	200	1000	200	1.494	0.692	125	0.0320	W4
F0900VC450	4500	816	10450	546 x 10 ³	120	3.80	230	1000	60	2.024	1.274	115	0.0160	W6
F0900VC520	5200	816	10450	546 x 10 ³	120	3.80	230	1000	60	2.024	1.274	115	0.0160	W6
F0900VF450	4500	816	10450	546 x 10 ³	120	3.80	230	1000	60	2.024	1.274	115	0.0160	W43
F0900VF520	5200	816	10450	546 x 10 ³	120	3.80	230	1000	60	2.024	1.274	115	0.0160	W43
F1000LC080	800	826	8500	361 x 10 ³	320	1.60	250	1000	800	1.530	0.547	125	0.0320	W4
F1000LC120	1200	826	8500	361 x 10 ³	320	1.60	250	1000	800	1.530	0.547	125	0.0320	W4
F1300NC45P	4500	1346	20800	2.16 x 10 ⁶	470	4.30	2150	1000	200	1.569	0.318	140	0.0240	W5
F1300NC50P	5000	1346	20800	2.16 x 10 ⁶	470	4.30	2150	1000	200	1.569	0.318	140	0.0240	W5
F1300NC55P	5500	1346	20800	2.16 x 10 ⁶	470	4.30	2150	1000	200	1.569	0.318	140	0.0240	W5
F1400NC140	1400	1093	17250	1.49 x 10 ⁶	800	1.50	1000	1400	1000	1.618	0.388	125	0.0240	W5
F1400NC180	1800	1093	17250	1.49 x 10 ⁶	800	1.50	1000	1400	1000	1.618	0.388	125	0.0240	W5
F1500NC200	2000	1054	13750	950 x 10 ³	1065	1.50	1500	1500	2000	1.372	0.535	125	0.0240	W5
F1500NC250	2500	1054	13750	950 x 10 ³	1065	1.50	1500	1500	2000	1.372	0.535	125	0.0240	W5
F1600NC080	800	1326	20000	2.0 x 10 ⁶	480	2.30	700	1600	800	1.320	0.268	125	0.0240	W5
F1600NC120	1200	1326	20000	2.0 x 10 ⁶	480	2.30	700	1600	800	1.320	0.268	125	0.0240	W5

Outlines on pages O-01...O-35



W1 Weight 70 g



W2 Weight 80 g



W3 Weight 140 g



W4 Weight 340 g



W5 Weight 510 g



W6 Weight 1 kg

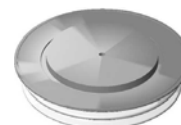

W43 Weight 800 g

High Power Sonic FRD's

IXYS UK brings you a world-leading class of ultra fast and ultra soft recovery diode available from 1.7kV to 6.5kV in current ratings from 170A to 4000A. These diodes incorporate a unique manufacturing process and lifetime control to offer a class leading trade-off between conduction and switching losses. The wide safe operating area (SOA) makes them ideal as freewheeling diodes for snubberless IGBT and IGCT applications or any application which requires a fast, low loss diode. For example, traction, medium voltage drives, induction heating and pulsed power applications.

Capsule Types

Part No.	V_{RRM}	I_{FAV}	I_{FSM}	I^2t	Typ. Reverse Recovery					V_{TO}	r_T	T_{JM}	R_{thJK}	Fig. No.
					I_{rm}	t_{rr}	Q_{rr}	@ I_{FM}	@ $-di_F/dt$					
○ Not for new design ➤ New	V	A	A	A ² s	A	μs	μC	A	A/μs	V	mΩ	°C	K/W	
E0330MF65F	6500	277	2790	38.9 x 10 ³	400	1.2	550	330	1000	1.890	5.80	125	0.0425	W99
E0460QC45E	4500	533	6800	231 x 10 ³	460	1.15	685	500	1000	2.246	2.716	140	0.0274	W68
E0660NC45E	4500	760	9160	420 x 10 ³	700	1.1	1050	660	1500	2.194	1.814	140	0.0200	W5
E0660NH45E	4500	760	9160	420 x 10 ³	700	1.1	1050	660	1500	2.194	1.814	140	0.0200	W47
E0770HF65F	6500	617	6973	243 x 10 ³	600	0.9	735	770	2000	2.777	2.03	125	0.0189	W100
E1000TF65F	6500	820	8455	357 x 10 ³	1000	1.2	1350	1000	2500	1.895	1.925	125	0.0141	W97
E1250HC45E	4500	1355	20500	2.11 x 10 ⁶	1000	1.2	1850	1250	2000	2.072	1.166	140	0.0105	W122
E1375EF65F	6500	1125	12180	742 x 10 ³	1600	1.1	2100	1375	3500	1.890	1.423	125	0.0106	W101
➤ E1500MC33E	3300	1580	17330	1.5 x 10 ⁶	1380	1.85	2040	1500	2000	1.509	0.464	140	0.0162	W54
E1500NC36P	3600	1280	17050	1.45 x 10 ⁶	1425	2.8	2750	1000	1000	1.417	0.656	140	0.0190	W5
E1500NC42P	4200	1280	17050	1.45 x 10 ⁶	1425	2.8	2750	1000	1000	1.417	0.656	140	0.0190	W5
E1500NC48P	4800	1280	17050	1.45 x 10 ⁶	1425	2.8	2750	1000	1000	1.417	0.656	140	0.0190	W5
E1500NH36P	3600	1280	17050	1.45 x 10 ⁶	1425	2.8	2750	1000	1000	1.417	0.656	140	0.0190	W47
E1500NH42P	4200	1280	17050	1.45 x 10 ⁶	1425	2.8	2750	1000	1000	1.417	0.656	140	0.0190	W47
E1500NH48P	4800	1280	17050	1.45 x 10 ⁶	1425	2.8	2750	1000	1000	1.417	0.656	140	0.0190	W47
➤ E1680NC17F	1700	785	8355	349 x 10 ³	950	0.45	540	1680	8500	1.364	0.584	125	0.0357	W5
E1800TC45E	4500	2215	29050	4.22 x 10 ⁶	1490	1.15	2800	1800	3000	2.171	0.634	140	0.0068	W28
E2060FF65F	6500	1690	17400	1.51 x 10 ⁶	2050	1.1	2800	2060	4500	1.845	0.951	125	0.0071	W105
E2400EC45E	4500	2490	32100	5.15 x 10 ⁶	2130	1.22	3900	2400	4000	2.114	0.646	140	0.0056	W111
E3000EC45E	4500	3410	45700	10.5 x 10 ⁶	3050	1.25	5000	3000	5000	2.124	0.339	140	0.0050	W111
E4000FD45E	4500	4210	54800	15.0 x 10 ⁶	3650	1.5	5750	4000	5000	2.117	0.351	140	0.0035	W59

Outlines on pages
O-01...O-35



W5 Weight 510 g



W28 Weight 1.23 kg



W47 Weight 250 g



W54 Weight 530 g



W59 Weight 2.25 kg



W68 Weight 300 g



W97 Weight 1 kg

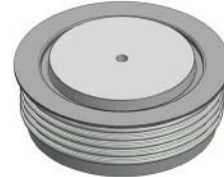

W99 Weight 500 g



W100 Weight 600 g

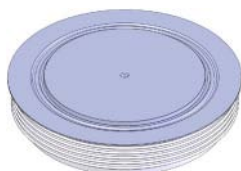

W101 Weight 1.5 kg

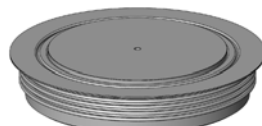

W105 Weight 2.3 kg



W111 Weight 1.6 kg

Phase Control Thyristors

IXYS UK provides one of the most comprehensive ranges of standard phase control thyristors in the industry. Devices with voltage ranges from 200V to 6500V are available, making them suitable for applications with line voltages from 230V to over 1000V (higher voltage applications are now served by our range of Medium Voltage Thyristors). IXYS UK Westcode Ltd. is a leading supplier of phase control products into demanding markets such as industrial DC drives, controlled rectifiers, marine/rail propulsion systems, wind power converters, electrochemical power supplies and soft starters. These devices are optimised to give low conduction losses and are primarily intended for applications with line frequencies up to 400Hz.

The Wespac outline (WPxx) is an innovative concept in phase control thyristors for applications requiring devices rated to 2200V. It gives the maximum power rating for weight and volume without compromising on quality and reliability. It also gives the maximum current rating and lowest thermal resistance for the package size.

The newest additions to IXYS UK's phase control thyristor range are the 96mm diameter die capsules. These devices are constructed using low temperature sintering technology offering better thermal and electromechanical capability and are available with current ratings up to 6405A and voltage ratings up to 4500V.

Stud Types

Part No.	V_{DRM}	I_{TAV}	I_{TSM}	I^2t	V_{TO}	r_T	T_{JM}	R_{thJC}		Fig. No.
	V_{RRM}	$T_C = 55^\circ C$	10 ms $\frac{1}{2}$ sine $V_R - \leq 60\% V_{RRM}$		@ T_{JM}		d.c. 180° sine	120° Rect.		
	V	A	A	A^2s	V	mΩ	°C	K/W	K/W	
N0180SH120	1200	180	2450	30.0×10^3	0.900	1.790	125	0.2300	0.2800	W17
N0180SH160	1600	180	2450	30.0×10^3	0.900	1.790	125	0.2300	0.2800	W17
N0335SC120	1200	335	4650	108×10^3	0.920	0.990	125	0.1200	0.1400	W18
N0335SC160	1600	335	4650	108×10^3	0.920	0.990	125	0.1200	0.1400	W18
N0416SC040	400	416	6000	180×10^3	0.850	0.535	125	0.1200	0.1400	W18
N0416SC080	800	416	6000	180×10^3	0.850	0.535	125	0.1200	0.1400	W18

Outlines on pages
O-01...O-35

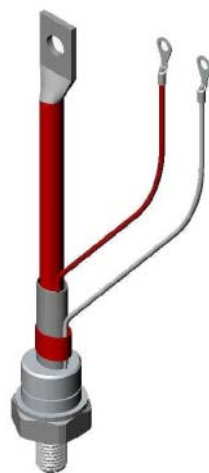



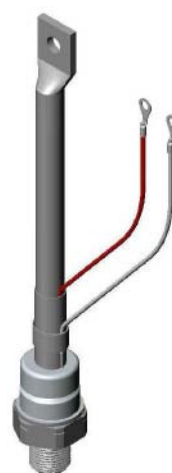







W17 Weight 130 g



W18 Weight 280 g









Phase Control Thyristors

Capsule Types

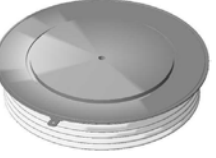
Part No. ○ Not for new design ➤ New	V_{DRM} V_{RRM}	I_{TAV} $T_K = 55^\circ C$	I_{TSM}	I^2t 10 ms ½ sine $V_R - \leq 60\% V_{RRM}$	V_{TO}	r_T @ T_{JM}	T_{JM}	R_{thJK}		Fig. No.	Package style Outlines on pages O-01...O-35
	V	A	A	A ² s	V	mΩ	°C	180° Sine K/W	120° Rect. K/W		
N0465WN140	1400	465	4500	101 x 10 ³	0.900	0.850	125	0.0800	0.0912	W90	 W10 Weight 340 g
N0465WN160	1600	465	4500	101 x 10 ³	0.900	0.850	125	0.0800	0.0912	W90	
N0530YN220	2200	530	6300	198 x 10 ³	1.100	1.250	125	0.0480	0.0494	W91	 W11 Weight 510 g
N0530YN250	2500	530	6300	198 x 10 ³	1.100	1.250	125	0.0480	0.0494	W91	
N0616LC400	4000	616	5250	138 x 10 ³	1.220	1.530	125	0.0320	0.0393	W10	 W11 Weight 510 g
N0616LC450	4500	616	5250	138 x 10 ³	1.220	1.530	125	0.0320	0.0393	W10	
N0634LC380	3800	634	7000	245 x 10 ³	1.100	1.500	125	0.0320	0.0393	W10	 W12 Weight 1 kg
N0634LC420	4200	634	7000	245 x 10 ³	1.100	1.500	125	0.0320	0.0393	W10	
N0646LC300	3000	646	5700	162 x 10 ³	1.210	1.360	125	0.0320	0.0393	W10	 W11 Weight 510 g
N0646LC360	3600	646	5700	162 x 10 ³	1.210	1.360	125	0.0320	0.0393	W10	
N0795YN140	1400	795	9450	444 x 10 ³	0.950	0.450	125	0.0480	0.0494	W91	 W12 Weight 1 kg
N0795YN180	1800	795	9450	444 x 10 ³	0.950	0.450	125	0.0480	0.0494	W91	
N0882NC400	4000	882	7700	296 x 10 ³	1.300	0.920	125	0.0240	0.0273	W11	 W12 Weight 1 kg
N0882NC450	4500	882	7700	296 x 10 ³	1.300	0.920	125	0.0240	0.0273	W11	
N0910LC200	2000	910	9200	423 x 10 ³	1.040	0.606	125	0.0320	0.0393	W10	 W62 Weight 1 kg
N0910LC260	2600	910	9200	423 x 10 ³	1.040	0.606	125	0.0320	0.0393	W10	
N0910LC280	2800	910	9200	423 x 10 ³	1.040	0.606	125	0.0320	0.0393	W10	
N1010NC300	3000	1010	12100	732 x 10 ³	1.170	0.687	125	0.0240	0.0273	W11	 W90 Weight 90 g
N1010NC380	3800	1010	12100	732 x 10 ³	1.170	0.687	125	0.0240	0.0273	W11	
➤ N1052LC200	2000	1052	13200	870 x 10 ³	1.000	0.416	125	0.0320	0.0393	W10	 W91 Weight 110 g
➤ N1052LC220	2200	1052	13200	870 x 10 ³	1.000	0.416	125	0.0320	0.0393	W10	
N1075LN180	1800	1240	15750	1.24 x 10 ⁶	0.850	0.320	130	0.0330	0.0371	W92	 W92 Weight 280 g
N1132NC300	3000	1132	14300	1.02 x 10 ⁶	1.150	0.510	125	0.0240	0.0271	W11	
N1132NC340	3400	1132	14300	1.02 x 10 ⁶	1.150	0.510	125	0.0240	0.0271	W11	
N1132NC360	3600	1132	14300	1.02 x 10 ⁶	1.150	0.510	125	0.0240	0.0271	W11	 W91 Weight 110 g
N1140LN140	1400	1315	17500	1.53 x 10 ⁶	0.820	0.280	130	0.0330	0.0371	W92	
N1159NC380	3800	1159	14500	1.05 x 10 ⁶	1.100	0.574	125	0.0220	0.0255	W11	 W91 Weight 110 g
N1159NC420	4200	1159	14500	1.05 x 10 ⁶	1.100	0.574	125	0.0220	0.0255	W11	
N1174JK200	2000	1174	13200	870 x 10 ³	1.000	0.416	125	0.0270	0.0314	WP1	 W92 Weight 280 g
N1174JK220	2200	1174	13200	870 x 10 ³	1.000	0.416	125	0.0270	0.0314	WP1	
N1263JK160	1600	1263	15000	1.13 x 10 ⁶	1.015	0.332	125	0.0270	0.0314	WP1	 WP1 Weight 180 g
N1263JK180	1800	1263	15000	1.13 x 10 ⁶	1.015	0.332	125	0.0270	0.0314	WP1	
○ N1351VC400	4000	1351	17500	1.53 x 10 ⁶	1.200	0.553	125	0.0170	0.0206	W12	
○ N1351VC450	4500	1351	17500	1.53 x 10 ⁶	1.200	0.553	125	0.0170	0.0206	W12	 WP2 Weight 200 g
○ N1351VF400	4000	1351	17500	1.53 x 10 ⁶	1.200	0.553	125	0.0170	0.0206	W62	
○ N1351VF450	4500	1351	17500	1.53 x 10 ⁶	1.200	0.553	125	0.0170	0.0206	W62	 WP6 Weight 200 g
N1366JK080	800	1366	15900	1.26 x 10 ⁶	0.985	0.270	125	0.0270	0.0314	WP1	
N1366JK120	1200	1366	15900	1.26 x 10 ⁶	0.985	0.270	125	0.0270	0.0314	WP1	
N1366JK140	1400	1366	15900	1.26 x 10 ⁶	0.985	0.270	125	0.0270	0.0314	WP1	 WP6 Weight 200 g
○ N1449QL200	2000	1410	17300	1.50 x 10 ⁶	1.060	0.317	125	0.0230	0.0272	WP6	
○ N1449QL220	2200	1410	17300	1.50 x 10 ⁶	1.060	0.317	125	0.0230	0.0272	WP6	 WP6 Weight 200 g
N1467NC200	2000	1467	21500	2.31 x 10 ⁶	1.000	0.272	125	0.0240	0.0271	W11	
N1467NC260	2600	1467	21500	2.31 x 10 ⁶	1.000	0.272	125	0.0240	0.0271	W11	 WP6 Weight 330 g
N1547NC160	1600	1547	23300	2.71 x 10 ⁶	0.920	0.252	125	0.0240	0.0271	W11	
N1547NC200	2000	1547	23300	2.71 x 10 ⁶	0.920	0.252	125	0.0240	0.0271	W11	





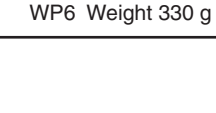



Phase Control Thyristors

Capsule Types

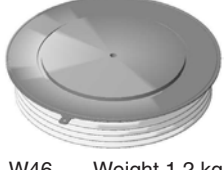
Part No. <small>○ Not for new design</small>	V_{DRM}	I_{TAV}	I_{TSM}	I^2t	V_{TO}	r_T	T_{JM}	R_{thJK}		Fig. No.	Package style Outlines on pages O-01...O-35
	V_{RRM} V	$T_K = 55^\circ C$ A	10 ms A	1/2 sine $V_R - \leq 60\% V_{RRM}$ A ² s	@ T_{JM} V	m Ω	°C	180° Sine K/W	120° Rect. K/W		
○ N1581QL160	1600	1535	19100	1.82×10^6	1.022	0.253	125	0.0230	0.0270	WP6	
○ N1581QL180	1800	1535	19100	1.82×10^6	1.022	0.253	125	0.0230	0.0270	WP6	
N1651QK200	2000	1651	17300	1.50×10^6	1.060	0.317	125	0.0180	0.0217	WP2	
N1651QK220	2200	1651	17300	1.50×10^6	1.060	0.317	125	0.0180	0.0217	WP2	
○ N1661VC300	3000	1661	23000	2.65×10^6	1.040	0.350	125	0.0170	0.0206	W12	
○ N1661VC360	3600	1661	23000	2.65×10^6	1.040	0.350	125	0.0170	0.0206	W12	
○ N1661VF300	3000	1661	23000	2.65×10^6	1.040	0.350	125	0.0170	0.0206	W62	
○ N1661VF360	3600	1661	23000	2.65×10^6	1.040	0.350	125	0.0170	0.0206	W62	
N1718NC120	1200	1718	27200	3.70×10^6	0.979	0.169	125	0.0240	0.0271	W11	
N1718NC180	1800	1718	27200	3.70×10^6	0.979	0.169	125	0.0240	0.0271	W11	
N1718NC200	2000	1718	27200	3.70×10^6	0.979	0.169	125	0.0240	0.0271	W11	
N1725MC320	3200	1725	20000	2.00×10^6	1.022	0.396	125	0.0150	0.0165	W70	
N1725MC360	3600	1725	20000	2.00×10^6	1.022	0.396	125	0.0150	0.0165	W70	
N1802NC120	1200	1802	29600	4.38×10^6	0.855	0.171	125	0.0240	0.0271	W11	
N1802NC160	1600	1802	29600	4.38×10^6	0.855	0.171	125	0.0240	0.0271	W11	
N1806QK160	1600	1806	19100	1.82×10^6	1.022	0.253	125	0.0180	0.0217	WP2	
N1806QK180	1800	1806	19100	1.82×10^6	1.022	0.253	125	0.0180	0.0217	WP2	
○ N1817QL080	800	1760	22000	2.42×10^6	0.955	0.177	125	0.0230	0.0272	WP6	
○ N1817QL120	1200	1760	22000	2.42×10^6	0.955	0.177	125	0.0230	0.0272	WP6	
○ N1817QL140	1400	1760	22000	2.42×10^6	0.955	0.177	125	0.0230	0.0272	WP6	
○ N2015ML200	2000	2015	32400	5.25×10^6	0.883	0.210	125	0.0180	0.0201	WP5	
○ N2015ML220	2200	2015	32400	5.25×10^6	0.883	0.210	125	0.0180	0.0201	WP5	
N2055MC260	2600	2105	25800	3.33×10^6	0.970	0.240	125	0.0150	0.0165	W70	
N2055MC280	2800	2105	25800	3.33×10^6	0.970	0.240	125	0.0150	0.0165	W70	
N2055HE420	4200	2055	24000	2.88×10^6	0.977	0.342	125	0.0125	0.0138	W80	
N2055HE450	4500	2055	24000	2.88×10^6	0.977	0.342	125	0.0125	0.0138	W80	
N2083QK080	800	2083	22000	2.42×10^6	0.955	0.177	125	0.0180	0.0217	WP2	
N2083QK120	1200	2083	22000	2.42×10^6	0.955	0.177	125	0.0180	0.0217	WP2	
N2083QK140	1400	2083	22000	2.42×10^6	0.955	0.177	125	0.0180	0.0217	WP2	
N2086NC060	600	2086	35000	6.13×10^6	0.840	0.108	125	0.0240	0.0271	W11	
N2086NC100	1000	2086	35000	6.13×10^6	0.840	0.108	125	0.0240	0.0271	W11	
N2154JK020	200	2154	22700	2.58×10^6	0.890	0.107	140	0.0270	0.0314	WP1	
N2154JK040	400	2154	22700	2.58×10^6	0.890	0.107	140	0.0270	0.0314	WP1	
N2154JK060	600	2154	22700	2.58×10^6	0.890	0.107	140	0.0270	0.0314	WP1	
N2172ZC420	4200	2172	28000	3.92×10^6	1.350	0.294	125	0.0110	0.0119	W13	
N2172ZC450	4500	2172	28000	3.92×10^6	1.350	0.294	125	0.0110	0.0119	W13	
N2172ZD420	4200	2172	28000	3.92×10^6	1.350	0.294	125	0.0110	0.0119	W46	
N2172ZD450	4500	2172	28000	3.92×10^6	1.350	0.294	125	0.0110	0.0119	W46	
○ N2191ML160	1600	2191	34500	5.95×10^6	0.940	0.154	125	0.0180	0.0201	WP5	
○ N2191ML180	1800	2191	34500	5.95×10^6	0.940	0.154	125	0.0180	0.0201	WP5	
N2285HA420	4200	2285	24000	2.88×10^6	0.977	0.342	125	0.0105	0.0118	W79	
N2285HA450	4500	2285	24000	2.88×10^6	0.977	0.342	125	0.0105	0.0118	W79	
N2367MK200	2000	2367	32400	5.25×10^6	0.883	0.210	125	0.0140	0.0157	WP3	
N2367MK220	2200	2367	32400	5.25×10^6	0.883	0.210	125	0.0140	0.0157	WP3	
N2385HE320	3200	2385	28400	4.03×10^6	0.910	0.243	125	0.0125	0.0138	W80	
N2385HE360	3600	2385	28400	4.03×10^6	0.910	0.243	125	0.0125	0.0138	W80	

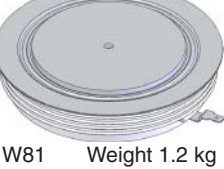





Phase Control Thyristors

Capsule Types

Part No. ○ Not for new design	V_{DRM}	I_{TAV}	I_{TSM}	I^2t 10 ms ½ sine $V_R - \leq 60\% V_{RRM}$	V_{TO}	r_T @ T_{JM}	T_{JM}	R_{thJK}		Fig. No.	Package style Outlines on pages O-01...O-35
	V_{RRM}	$T_K = 55^\circ C$						180° Sine K/W	120° Rect. K/W		
	V	A	A	A ² S	V	mΩ	°C	K/W	K/W		
N2418ZC300	3000	2418	30000	4.50 x 10 ⁶	1.160	0.246	125	0.0110	0.0119	W13	
N2418ZC360	3600	2418	30000	4.50 x 10 ⁶	1.160	0.246	125	0.0110	0.0119	W13	
N2418ZD300	3000	2418	30000	4.50 x 10 ⁶	1.160	0.246	125	0.0110	0.0119	W46	
N2418ZD360	3600	2418	30000	4.50 x 10 ⁶	1.160	0.246	125	0.0110	0.0119	W46	
N2500VC120	1200	2500	37000	6.85 x 10 ⁶	0.880	0.124	125	0.0170	0.0206	W12	
N2500VC160	1600	2500	37000	6.85 x 10 ⁶	0.880	0.124	125	0.0170	0.0206	W12	
N2500VF120	1200	2500	37000	6.85 x 10 ⁶	0.880	0.124	125	0.0170	0.0206	W62	
N2500VF160	1600	2500	37000	6.85 x 10 ⁶	0.880	0.124	125	0.0170	0.0206	W62	
○ N2520ML080	800	2520	38200	7.30 x 10 ⁶	0.980	0.090	125	0.0180	0.0201	WP5	
○ N2520ML120	1200	2520	38200	7.30 x 10 ⁶	0.980	0.090	125	0.0180	0.0201	WP5	
○ N2520ML140	1400	2520	38200	7.30 x 10 ⁶	0.980	0.090	125	0.0180	0.0201	WP5	
N2543ZC240	2400	2543	32000	5.12 x 10 ⁶	0.780	0.274	125	0.0110	0.0119	W13	
N2543ZC300	3000	2543	32000	5.12 x 10 ⁶	0.780	0.274	125	0.0110	0.0119	W13	
N2543ZD240	2400	2543	32000	5.12 x 10 ⁶	0.780	0.274	125	0.0110	0.0119	W46	
N2543ZD300	3000	2543	32000	5.12 x 10 ⁶	0.780	0.274	125	0.0110	0.0119	W46	
N2593MK160	1600	2593	34500	5.95 x 10 ⁶	0.940	0.154	125	0.0140	0.0157	WP3	
N2593MK180	1800	2593	34500	5.95 x 10 ⁶	0.940	0.154	125	0.0140	0.0157	WP3	
N2600MC160	1600	2600	30000	4.50 x 10 ⁶	0.950	0.130	125	0.0150	0.0165	W70	
N2600MC180	1800	2600	30000	4.50 x 10 ⁶	0.950	0.130	125	0.0150	0.0165	W70	
N2655HA320	3200	2655	28400	4.03 x 10 ⁶	0.910	0.243	125	0.0105	0.0118	W79	
N2655HA360	3600	2655	28400	4.03 x 10 ⁶	0.910	0.243	125	0.0105	0.0118	W79	
N2825TE420	4200	2825	36900	6.81 x 10 ⁶	1.210	0.270	125	0.0080	0.0085	W82	
N2825TE450	4500	2825	36900	6.81 x 10 ⁶	1.210	0.270	125	0.0080	0.0085	W82	
N2825TJ420	4200	2825	36900	6.81 x 10 ⁶	1.210	0.270	125	0.0080	0.0085	W81	
N2825TJ450	4500	2825	36900	6.81 x 10 ⁶	1.210	0.270	125	0.0080	0.0085	W81	
N2830HE260	2600	2830	36000	6.48 x 10 ⁶	0.930	0.150	125	0.0125	0.0138	W80	
N2830HE280	2800	2830	36000	6.48 x 10 ⁶	0.930	0.150	125	0.0125	0.0138	W80	
○ N2900QL020	200	2900	28000	3.92 x 10 ⁶	0.850	0.080	150	0.0230	0.0272	WP6	
○ N2900QL040	400	2900	28000	3.92 x 10 ⁶	0.850	0.080	150	0.0230	0.0272	WP6	
○ N2900QL060	600	2900	28000	3.92 x 10 ⁶	0.850	0.080	150	0.0230	0.0272	WP6	
N3012ZC200	2000	3012	45100	10.2 x 10 ⁶	0.920	0.160	125	0.0110	0.0119	W13	
N3012ZC260	2600	3012	45100	10.2 x 10 ⁶	0.920	0.160	125	0.0110	0.0119	W13	
N3012ZD200	2000	3012	45100	10.2 x 10 ⁶	0.920	0.160	125	0.0110	0.0119	W46	
N3012ZD260	2600	3012	45100	10.2 x 10 ⁶	0.920	0.160	125	0.0110	0.0119	W46	
N3022MK080	800	3022	38200	7.30 x 10 ⁶	0.981	0.090	125	0.0140	0.0157	WP3	
N3022MK120	1200	3022	38200	7.30 x 10 ⁶	0.981	0.090	125	0.0140	0.0157	WP3	
N3022MK140	1400	3022	38200	7.30 x 10 ⁶	0.981	0.090	125	0.0140	0.0157	WP3	
N3029ZC240	2400	3029	38200	7.30 x 10 ⁶	0.947	0.154	125	0.0110	0.0119	W13	
N3029ZC280	2800	3029	38200	7.30 x 10 ⁶	0.947	0.154	125	0.0110	0.0119	W13	
N3029ZD240	2400	3029	38200	7.30 x 10 ⁶	0.947	0.154	125	0.0110	0.0119	W46	
N3029ZD280	2800	3029	38200	7.30 x 10 ⁶	0.947	0.154	125	0.0110	0.0119	W46	
N3165HA260	2600	3165	36000	6.48 x 10 ⁶	0.930	0.150	125	0.0105	0.0118	W79	
N3165HA280	2800	3165	36000	6.48 x 10 ⁶	0.930	0.150	125	0.0105	0.0118	W79	
N3175HE160	1600	3175	45500	10.40 x 10 ⁶	0.900	0.110	125	0.0125	0.0138	W80	
N3175HE180	1800	3175	45500	10.40 x 10 ⁶	0.900	0.110	125	0.0125	0.0138	W80	

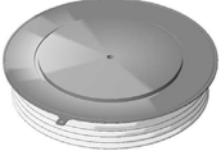

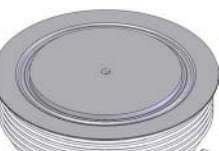
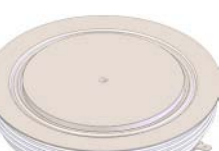

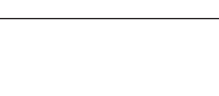

Phase Control Thyristors

Capsule Types

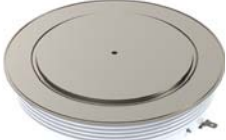
Part No.	V _{DRM} V _{RRM}	I _{TAV} T _K = 55°C	I _{TSM}	I ² t 10 ms ½ sine V _R - ≤ 60% V _{RRM}	V _{TO}	r _T	T _{JM}	R _{thJK}		Fig. No.	Package style Outlines on pages O-01...O-35	
	> New V	A	A	A ² s	V	mΩ	°C	180° Sine K/W	120° Rect. K/W			
N3229QK020	200	3229	28000	3.92 x 10 ⁶	0.926	0.067	140	0.0180	0.0217	WP2		
N3229QK040	400	3229	28000	3.92 x 10 ⁶	0.926	0.067	140	0.0180	0.0217	WP2		
N3229QK060	600	3229	28000	3.92 x 10 ⁶	0.926	0.067	140	0.0180	0.0217	WP2		
N3533ZC140	1400	3533	50000	12.5 x 10 ⁶	0.970	0.095	125	0.0110	0.0120	W13	 W13 Weight 1.7 kg	
N3533ZC180	1800	3533	50000	12.5 x 10 ⁶	0.970	0.095	125	0.0110	0.0120	W13		
N3533ZC220	2200	3533	50000	12.5 x 10 ⁶	0.970	0.095	125	0.0110	0.0120	W13		
N3533ZD140	1400	3533	50000	12.5 x 10 ⁶	0.970	0.095	125	0.0110	0.0120	W46		
N3533ZD180	1800	3533	50000	12.5 x 10 ⁶	0.970	0.095	125	0.0110	0.0120	W46		
N3533ZD220	2200	3533	50000	12.5 x 10 ⁶	0.970	0.095	125	0.0110	0.0120	W46		
N3565HA160	1600	3565	45500	10.4 x 10 ⁶	0.900	0.110	125	0.0105	0.0118	W79	 W79	
N3565HA180	1800	3565	45500	10.4 x 10 ⁶	0.900	0.110	125	0.0105	0.0118	W79		
○ N3597ML020	200	3597	45400	10.3 x 10 ⁶	0.840	0.053	140	0.0180	0.0201	WP5	 WP5	
○ N3597ML040	400	3597	45400	10.3 x 10 ⁶	0.840	0.053	140	0.0180	0.0201	WP5		
○ N3597ML060	600	3597	45400	10.3 x 10 ⁶	0.840	0.053	140	0.0180	0.0201	WP5		
N3620TE320	3200	3620	52500	11.2 x 10 ⁶	0.911	0.168	125	0.0080	0.0085	W82	 W82 Weight 1.2 kg	
N3620TE360	3600	3620	52500	11.2 x 10 ⁶	0.911	0.168	125	0.0080	0.0085	W82		
N3620TJ320	3200	3620	52500	11.2 x 10 ⁶	0.911	0.168	125	0.0080	0.0085	W81		
N3620TJ360	3600	3620	52500	11.2 x 10 ⁶	0.911	0.168	125	0.0080	0.0085	W81		
N3790TE240	2400	3790	49500	12.3 x 10 ⁶	0.900	0.150	125	0.0080	0.0085	W82	 W81 Weight 1.2 kg	
N3790TE280	2800	3790	49500	12.3 x 10 ⁶	0.900	0.150	125	0.0080	0.0085	W82		
N3790TJ240	2400	3790	49500	12.3 x 10 ⁶	0.900	0.150	125	0.0080	0.0085	W81		
N3790TJ280	2800	3790	49500	12.3 x 10 ⁶	0.900	0.150	125	0.0080	0.0085	W81		
N3880ZD160	1600	3880	59000	17.4 x 10 ⁶	0.986	0.068	125	0.0110	0.0119	W46	 W46	
N3880ZD180	1800	3880	59000	17.4 x 10 ⁶	0.986	0.068	125	0.0110	0.0119	W46		
N3904HK200	2000	3904	50900	12.95 x 10 ⁶	0.920	0.111	125	0.0090	0.0099	WP4	 WP4	
N3904HK220	2200	3904	50900	12.95 x 10 ⁶	0.920	0.111	125	0.0090	0.0099	WP4		
N3930ZC120	1200	3930	54000	14.6 x 10 ⁶	0.841	0.080	125	0.0110	0.0119	W13		
N3930ZC160	1600	3930	54000	14.6 x 10 ⁶	0.841	0.080	125	0.0110	0.0119	W13		
N3930ZD120	1200	3930	54000	14.6 x 10 ⁶	0.841	0.080	125	0.0110	0.0119	W46		
N3930ZD160	1600	3930	54000	14.6 x 10 ⁶	0.841	0.080	125	0.0110	0.0119	W46		
N4085ZC080	800	4085	64000	20.5 x 10 ⁶	0.850	0.070	125	0.0110	0.0119	W13	 W13	
N4085ZC120	1200	4085	64000	20.5 x 10 ⁶	0.850	0.070	125	0.0110	0.0119	W13		
N4085ZD080	800	4085	64000	20.5 x 10 ⁶	0.850	0.070	125	0.0110	0.0119	W46	 W46	
N4085ZD120	1200	4085	64000	20.5 x 10 ⁶	0.850	0.070	125	0.0110	0.0119	W46		
> N4165EE420	4200	4165	56000	15.7 x 10 ⁶	0.977	0.177	125	0.0060	0.0064	W108	 W107 Weight 1.6 kg	
> N4165EE450	4500	4165	56000	15.7 x 10 ⁶	0.977	0.177	125	0.0060	0.0064	W108		
N4316MK020	200	4316	45400	10.3 x 10 ⁶	0.840	0.053	140	0.0140	0.0157	WP3	 WP3	
N4316MK040	400	4316	45400	10.3 x 10 ⁶	0.840	0.053	140	0.0140	0.0157	WP3		
N4316MK060	600	4316	45400	10.3 x 10 ⁶	0.840	0.053	140	0.0140	0.0157	WP3		
N4340TE180	1800	4340	55000	15.1 x 10 ⁶	0.886	0.105	125	0.0080	0.0085	W82	 W82	
N4340TE220	2200	4340	55000	15.1 x 10 ⁶	0.886	0.105	125	0.0080	0.0085	W82		
N4340TJ180	1800	4340	55000	15.1 x 10 ⁶	0.886	0.105	125	0.0080	0.0085	W81		
N4340TJ220	2200	4340	55000	15.1 x 10 ⁶	0.886	0.105	125	0.0080	0.0085	W81		
N4472HK160	1600	4472	59000	17.40 x 10 ⁶	0.986	0.068	125	0.0090	0.0099	WP4		 W108 Weight 2.1 kg
N4472HK180	1800	4472	59000	17.40 x 10 ⁶	0.986	0.068	125	0.0090	0.0099	WP4		

Phase Control Thyristors

Capsule Types

Part No.	V_{DRM}	I_{TAV}	I_{TSM}	I^2t	V_{T0}	r_T	T_{JM}	R_{thJK}		Fig. No.	Package style
	V_{RRM}	$T_K = 55^\circ C$	10 ms $\frac{1}{2}$ sine $V_R - \leq 60\% V_{RRM}$	10 ms $\frac{1}{2}$ sine $V_R - \leq 60\% V_{RRM}$	@ T_{JM}	$^\circ C$	180° Sine K/W	120° Rect. K/W			
➤ New	V	A	A	A ² s	V	mΩ	°C	K/W	K/W		Outlines on pages O-01...O-35
➤ N4650EA420	4200	4650	56000	15.7 x 10 ⁶	0.977	0.177	125	0.0050	0.0054	W107	
➤ N4650EA450	4500	4650	56000	15.7 x 10 ⁶	0.977	0.177	125	0.0050	0.0054	W107	
➤ N4845EE320	3200	4845	65000	21.1 x 10 ⁶	0.913	0.125	125	0.0060	0.0065	W108	
➤ N4845EE360	3600	4845	65000	21.1 x 10 ⁶	0.913	0.125	125	0.0060	0.0065	W108	
➤ N4940HK120	1200	4940	62000	19.0 x 10 ⁶	0.939	0.520	125	0.0090	0.0099	WP4	
➤ N4940HK140	1400	4940	62000	19.0 x 10 ⁶	0.939	0.520	125	0.0090	0.0099	WP4	
N5320FE420	4200	5320	78000	30.42 x 10 ⁶	1.060	0.130	125	0.0048	0.0051	W119	
N5320FE450	4500	5320	78000	30.42 x 10 ⁶	1.060	0.130	125	0.0048	0.0051	W119	
➤ N5415EA320	3200	5415	65000	21.1 x 10 ⁶	0.913	0.125	125	0.0050	0.0054	W107	
➤ N5415EA360	3600	5415	65000	21.1 x 10 ⁶	0.913	0.125	125	0.0050	0.0054	W107	
➤ N5715EE240	2400	5715	80000	32.0 x 10 ⁶	0.840	0.085	125	0.0060	0.0065	W108	
➤ N5715EE280	2800	5715	80000	32.0 x 10 ⁶	0.840	0.085	125	0.0060	0.0065	W108	
N5910FA420	4200	5910	78000	30.42 x 10 ⁶	1.060	0.130	125	0.0040	0.0044	W118	
N5910FA450	4500	5910	78000	30.42 x 10 ⁶	1.060	0.130	125	0.0040	0.0044	W118	
N6012ZD020	200	6012	65000	21.13 x 10 ⁶	0.853	0.029	140	0.0110	0.0119	W46	
N6012ZD040	400	6012	65000	21.13 x 10 ⁶	0.853	0.029	140	0.0110	0.0119	W46	
N6012ZD060	600	6012	65000	21.13 x 10 ⁶	0.853	0.029	140	0.0110	0.0119	W46	
➤ N6405EA240	2400	6405	80000	32.0 x 10 ⁶	0.840	0.085	125	0.0050	0.0054	W107	
➤ N6405EA280	2800	6405	80000	32.0 x 10 ⁶	0.840	0.085	125	0.0050	0.0054	W107	
N6974HK020	200	6974	65000	21.13 x 10 ⁶	0.853	0.029	140	0.0090	0.0099	WP4	
N6974HK040	400	6974	65000	21.13 x 10 ⁶	0.853	0.029	140	0.0090	0.0099	WP4	
N6974HK060	600	6974	65000	21.13 x 10 ⁶	0.853	0.029	140	0.0090	0.0099	WP4	
➤ N7585FE240	2400	7535	110000	60.50 x 10 ⁶	0.780	0.062	125	0.0048	0.0051	W119	
➤ N7585FE280	2800	7535	110000	60.50 x 10 ⁶	0.780	0.062	125	0.0048	0.0051	W119	
➤ N7905FE180	1800	7905	117000	68.44 x 10 ⁶	0.770	0.056	125	0.0048	0.0051	W119	
➤ N7905FE220	2200	7905	117000	68.44 x 10 ⁶	0.770	0.056	125	0.0048	0.0051	W119	
➤ N8440FA240	2400	8440	110000	60.50 x 10 ⁶	0.780	0.062	125	0.0040	0.0044	W118	
➤ N8440FA280	2800	8440	110000	60.50 x 10 ⁶	0.780	0.062	125	0.0040	0.0044	W118	
➤ N8800FA180	1800	8800	117000	68.44 x 10 ⁶	0.770	0.056	125	0.0040	0.0044	W118	
➤ N8800FA220	2200	8800	117000	68.44 x 10 ⁶	0.770	0.056	125	0.0040	0.0044	W118	



W118 Weight 2.2 kg

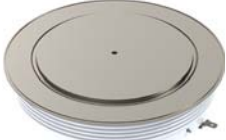

W119 Weight 2.9 kg



WP3 Weight 260 g



WP4 Weight 550 g

Medium Voltage Thyristors

Medium voltage applications place additional demands on phase controlled thyristors. To meet these demands we have developed a comprehensive range of thyristors optimised for medium voltage applications and series operation. As voltages increase, so do switching losses and turn-off time to a point where they become significant in line frequency applications. Our patented distributed gate architecture ensures excellent switching performance over a wide range of voltage, current and di/dt. Device lifetime is also engineered to achieve an optimum balance between conduction losses, commutation losses and turn-off time to give maximum power handling from line frequency to 400Hz. This also gives significant benefits when series or parallel connection of devices is required. Medium voltage thyristors are available from 3kV up to 6.5kV with silicon diameters from 38mm to 96mm making them particularly suitable for high power converters such as medium voltage DC drives, medium voltage soft starts and utility applications such as HVDC, static VAR compensators, excitation and transfer switches.

We recognise the importance of reliability in these large, capital intensive applications and as a result we subject these parts to extended levels of both routine and type testing to ensure that your investment gives years of trouble free service.

Capsule Types



Part No.	V_{DRM}	I_{TAV}	I_{TSM}	I^2t 10 ms 1/2 sine $V_R - \leq 60\% V_{RRM}$	t_q @ 200 V/ μ s	Typ. Reverse Recovery Charge			V_{TO}	r_T @ T_{JM}	T_{JM}	R_{thJK}		Fig. No.
	V_{RRM}	$T_K = 55^\circ C$				Q_{rr}	@ I_{TM}	@ -di/dt				180° Sine	120° Rect.	
	V	A	A	A ² s	μ s	μ C	A	A/ μ s	V	m Ω	°C	K/W	K/W	
K0445LG600	6000	450	6400	200×10^3	700-1000	3100	500	10	1.560	2.270	125	0.0380	0.0400	W56
K0445LG650	6500	450	6400	200×10^3	700-1000	3100	500	10	1.560	2.270	125	0.0380	0.0400	W56
K0500LC600	6000	500	6400	200×10^3	700-1000	3100	500	10	1.560	2.270	125	0.0320	0.0347	W10
K0500LC650	6500	500	6400	200×10^3	700-1000	3100	500	10	1.560	2.270	125	0.0320	0.0347	W10
K0560QE600	6000	575	7700	296×10^3	1000-1100	4400	700	10	1.460	1.750	125	0.0310	0.0329	W76
K0560QE650	6500	575	7700	296×10^3	1000-1100	4400	700	10	1.460	1.750	125	0.0310	0.0329	W76
K0625QA600	6000	640	7700	296×10^3	1000-1100	4750	1000	10	1.460	1.750	125	0.0260	0.0281	W75
K0625QA650	6500	640	7700	296×10^3	1000-1100	4750	1000	10	1.460	1.750	125	0.0260	0.0281	W75
K0890NC360	3600	890	10900	594×10^3	350-550	4000	1000	10	1.516	0.800	125	0.0240	0.0270	W11
K0890NC420	4200	890	10900	594×10^3	350-550	4000	1000	10	1.516	0.800	125	0.0240	0.0270	W11
K0900ME600	6000	1010	12600	794×10^3	850-1150	6200	1000	10	1.610	0.900	125	0.0180	0.0204	W78
K0900ME650	6500	1010	12600	794×10^3	850-1150	6200	1000	10	1.610	0.900	125	0.0180	0.0204	W78
K1010MA600	6000	1130	12600	794×10^3	850-1150	6200	1000	10	1.610	0.900	125	0.0150	0.0174	W77
K1010MA650	6500	1130	12600	794×10^3	850-1150	6200	1000	10	1.610	0.900	125	0.0150	0.0174	W77
K1121NC320	3200	1121	15000	1.13×10^6	200-300	2000	1000	10	1.098	0.542	125	0.0240	0.0270	W11
K1121NC360	3600	1121	15000	1.13×10^6	200-300	2000	1000	10	1.098	0.542	125	0.0240	0.0270	W11
K1197NC280	2800	1197	10650	567×10^3	200-300	2700	1000	10	1.335	0.372	125	0.0240	0.0270	W11
K1197NC320	3200	1197	10650	567×10^3	200-300	2700	1000	10	1.335	0.372	125	0.0240	0.0270	W11

Outlines on pages O-01...O-35



W10 Weight 340 g



W11 Weight 510 g



W56 Weight 271 g

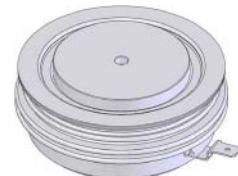

W75 Weight 330 g



W76 Weight 420 g



W77 Weight 550 g



W78 Weight 730 g

Medium Voltage Thyristors

Capsule Types

Part No.	V_{DRM}	I_{TAV}	I_{TSM}	I^2t	t_q	Typ. Reverse Recovery Charge			V_{TO}	r_T	T_{JM}	R_{thJK}		Fig. No.
	V_{RRM}	$T_K = 55^\circ C$	10 ms $\frac{1}{2}$ sine $V_R - \leq 60\% V_{RRM}$		@	T_{JM}			@ T_{JM}			180°	120°	
	V	A	A	A ² s	μs	Q_{rr}	@ I_{TM}	@ $-di/dt$	V	m Ω	°C	Sine	Rect.	
◇ K1210MA480	4800	1210	15300	1.17×10^6	750-1050	3550	1000	10	1.477	0.797	125	0.0150	0.0174	W77
◇ K1210MA520	5200	1210	15300	1.17×10^6	750-1050	3550	1000	10	1.477	0.797	125	0.0150	0.0174	W77
➤ K1270MA420	4200	1270	16700	1.39×10^6	650-950	2150	1000	10	1.331	0.741	125	0.0150	0.0174	W77
➤ K1270MA450	4500	1270	16700	1.39×10^6	650-950	2150	1000	10	1.331	0.741	125	0.0150	0.0174	W77
K1495HE600	6000	1495	21800	2.38×10^6	1200-1500	9000	1500	10	1.496	0.606	125	0.0125	0.0132	W80
K1495HE650	6500	1495	21800	2.38×10^6	1200-1500	9000	1500	10	1.496	0.606	125	0.0125	0.0132	W80
K1670HA600	6000	1670	21800	2.38×10^6	1200-1500	9000	1500	10	1.496	0.606	125	0.0105	0.0113	W79
K1670HA650	6500	1670	21800	2.38×10^6	1200-1500	9000	1500	10	1.496	0.606	125	0.0105	0.0113	W79
◇ K1785HA420	4200	1785	26600	3.53×10^6	1050-1350	5150	1500	10	1.373	0.536	125	0.0105	0.0113	W79
◇ K1785HA450	4500	1785	26600	3.53×10^6	1050-1350	5150	1500	10	1.373	0.536	125	0.0105	0.0113	W79
K1947ZC400	4000	1947	25000	3.13×10^6	600-700	8800	1000	10	1.221	0.425	125	0.0110	0.0119	W13
K1947ZC450	4500	1947	25000	3.13×10^6	600-700	8800	1000	10	1.221	0.425	125	0.0110	0.0119	W13
K1947ZD400	4000	1947	25000	3.13×10^6	600-700	8800	1000	10	1.221	0.425	125	0.0110	0.0119	W46
K1947ZD450	4500	1947	25000	3.13×10^6	600-700	8800	1000	10	1.221	0.425	125	0.0110	0.0119	W46
K2085TE600	6000	2145	33000	5.45×10^6	1450-1800	11000	3000	10	1.260	0.410	125	0.0095	0.0101	W82
K2085TE650	6500	2145	33000	5.45×10^6	1450-1800	11000	3000	10	1.260	0.410	125	0.0095	0.0101	W82
K2095ZC360	3600	2095	18200	1.66×10^6	400-500	4550	2000	10	1.502	0.296	125	0.0110	0.0119	W13
K2095ZC420	4200	2095	18200	1.66×10^6	400-500	4550	2000	10	1.502	0.296	125	0.0110	0.0119	W13
K2095ZD360	3600	2095	18200	1.66×10^6	400-500	4550	2000	10	1.502	0.296	125	0.0110	0.0119	W46
K2095ZD420	4200	2095	18200	1.66×10^6	400-500	4550	2000	10	1.502	0.296	125	0.0110	0.0119	W46
K2325TJ600	6000	2380	33000	5.45×10^6	1450-1800	11000	3000	10	1.260	0.410	125	0.0080	0.0085	W81
K2325TJ650	6500	2380	33000	5.45×10^6	1450-1800	11000	3000	10	1.260	0.410	125	0.0080	0.0085	W81
➤ K3745EA600	6000	3745	35400	6.26×10^6	1500-1800	14000	4000	10	1.320	0.270	125	0.0050	0.0054	W107
➤ K3745EA650	6500	3745	35400	6.26×10^6	1500-1800	14000	4000	10	1.320	0.270	125	0.0050	0.0054	W107
◇ K4005EA480	4800	4005	43200	9.33×10^6	1300-1600	8000	4000	10	1.359	0.216	125	0.0050	0.0054	W107
◇ K4005EA520	5200	4005	43200	9.33×10^6	1300-1600	8000	4000	10	1.359	0.216	125	0.0050	0.0054	W107
◇ K4215EA420	4200	4215	47000	11.0×10^6	1200-1500	4800	4000	10	1.224	0.201	125	0.0050	0.0054	W107
◇ K4215EA450	4500	4215	47000	11.0×10^6	1200-1500	4800	4000	10	1.224	0.201	125	0.0050	0.0054	W107

◇ New parts under development, please consult factory for more details.

Outlines on pages O-01...O-35



W13 Weight 1.7 kg



W46 Weight 1.2 kg



W77 Weight 550 g



W79 Weight 890 g



W80 Weight 1.2 kg



W81 Weight 1.2 kg



W82 Weight 1.65 kg







W107 Weight 1.6 kg

Fast Turn Off Thyristors

IXYS UK Westcode Ltd's „P“ series of fast switching thyristors have a regenerative gate structure to ensure low switching losses and high di/dt performance. „P“ series devices are suitable for existing inverters, DC chopper drives, UPS and Pulse Power applications. In addition to pressure contact technology these devices offer low reverse recovery charge values, low forward switching losses and high reliability. These devices are not recommended for new designs.

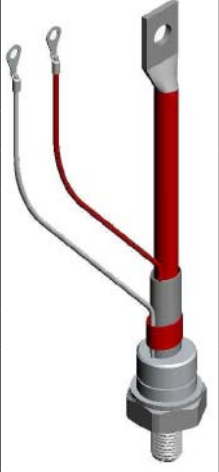
A new addition for 2019-20 is an M24 stud based assembly, with a current rating of 472A, voltage ratings up to 1600V and t_q starting at 25µs.

Stud Types

Part No.	V_{DRM}	I_{TAV}	I_{TSM}	I^2t	t_q	Typ. Reverse Recov. Charge			V_{TO}	r_T	R_{thJC}	Fig. No.	Package style Outlines on pages O-01...O-35
	V_{RRM}	$T_C = 55^\circ C$	10 ms ½ sine $V_R \leq 60\% V_{RRM}$		@ 200 V/µs	T_{JM}	@ I_{TM}	@ -di/dt	@ T_{JM}		180° sine		
○ Not for new design	V	A	A	A ² s	µs	µC	A	A/µs	V	mΩ	K/W		
○ P0128SH10C	1000	128	1700	19 x 10 ³	15	50	100	10	1.600	2.490	0.2300	W17	
○ P0128SH10D	1000	128	1700	19 x 10 ³	20	50	100	10	1.600	2.490	0.2300	W17	
○ P0128SH10E	1000	128	1700	19 x 10 ³	25	50	100	10	1.600	2.490	0.2300	W17	
○ P0128SH12C	1200	128	1700	19 x 10 ³	15	50	100	10	1.600	2.490	0.2300	W17	
○ P0128SH12D	1200	128	1700	19 x 10 ³	20	50	100	10	1.600	2.490	0.2300	W17	
○ P0128SH12E	1200	128	1700	19 x 10 ³	25	50	100	10	1.600	2.490	0.2300	W17	
○ P0128SJ10C	1000	128	1700	19 x 10 ³	15	50	100	10	1.600	2.490	0.2300	W16	
○ P0128SJ10D	1000	128	1700	19 x 10 ³	20	50	100	10	1.600	2.490	0.2300	W16	
○ P0128SJ10E	1000	128	1700	19 x 10 ³	25	50	100	10	1.600	2.490	0.2300	W16	
○ P0128SJ12C	1200	128	1700	19 x 10 ³	15	50	100	10	1.600	2.490	0.2300	W16	
○ P0128SJ12D	1200	128	1700	19 x 10 ³	20	50	100	10	1.600	2.490	0.2300	W16	
○ P0128SJ12E	1200	128	1700	19 x 10 ³	25	50	100	10	1.600	2.490	0.2300	W16	
R0472YC12EKER	1200	240	4000	80 x 10 ³	25	155	550	40	1.648	1.125	0.1249	W115	
R0472YC12FKER	1200	240	4000	80 x 10 ³	30	155	550	40	1.648	1.125	0.1249	W115	
R0472YC16EKER	1600	240	4000	80 x 10 ³	25	155	550	40	1.648	1.125	0.1249	W115	
R0472YC16FKER	1600	240	4000	80 x 10 ³	30	155	550	40	1.648	1.125	0.1249	W115	
○ P0248SC12D	1200	248	2700	36.5 x 10 ³	20	45	300	20	1.600	1.230	0.1200	W18	
○ P0248SC12E	1200	248	2700	36.5 x 10 ³	25	45	300	20	1.600	1.230	0.1200	W18	
○ P0273SC12D	1200	273	3250	52.8 x 10 ³	20	80	300	20	1.550	0.870	0.1200	W18	
○ P0273SC12E	1200	273	3250	52.8 x 10 ³	25	80	300	20	1.550	0.870	0.1200	W18	
○ P0273SC12F	1200	273	3250	52.8 x 10 ³	30	80	300	20	1.550	0.870	0.1200	W18	
○ P0306SC08A	800	306	4700	110 x 10 ³	10	50	300	20	1.400	0.670	0.1200	W18	
○ P0306SC08B	800	306	4700	110 x 10 ³	12	50	300	20	1.400	0.670	0.1200	W18	
○ P0306SC08C	800	306	4700	110 x 10 ³	15	50	300	20	1.400	0.670	0.1200	W18	
○ P0311SC12E	1200	311	3600	64.8 x 10 ³	25	55	300	20	1.170	0.920	0.1200	W18	
○ P0311SC12F	1200	311	3600	64.8 x 10 ³	30	55	300	20	1.170	0.920	0.1200	W18	
○ P0330SC04A	400	330	5000	125 x 10 ³	10	55	300	20	1.050	0.880	0.1200	W18	
○ P0330SC04C	400	330	5000	125 x 10 ³	15	55	300	20	1.050	0.880	0.1200	W18	
○ P0330SC06A	600	330	5000	125 x 10 ³	10	55	300	20	1.050	0.880	0.1200	W18	
○ P0330SC06C	600	330	5000	125 x 10 ³	15	55	300	20	1.050	0.880	0.1200	W18	
○ P0330SC08A	800	330	5000	125 x 10 ³	10	55	300	20	1.050	0.880	0.1200	W18	
○ P0330SC08C	800	330	5000	125 x 10 ³	15	55	300	20	1.050	0.880	0.1200	W18	
○ P0431SC04B	400	431	6500	211 x 10 ³	12	190	300	20	0.950	0.377	0.1200	W18	
○ P0431SC04C	400	431	6500	211 x 10 ³	15	190	300	20	0.950	0.377	0.1200	W18	
○ P0431SC06B	600	431	6500	211 x 10 ³	12	190	300	20	0.950	0.377	0.1200	W18	
○ P0431SC06C	600	431	6500	211 x 10 ³	15	190	300	20	0.950	0.377	0.1200	W18	

$T_{JM} = 125^\circ C$

W115 Weight 650 g

Fast Turn Off Thyristors

Capsule Types

Part No.	V _{DRM}	I _{TAV}	I _{TSM}	I ² t	t _q	Typ. Reverse Recovery Charge			V _{T0}	r _T	R _{thJC}	Fig. No.	Package style Outlines on pages O-01...O-35
	V _{RRM}	T _K = 55°C	10 ms ½ sine V _R - ≤ 60% V _{RRM}		@ 200 V/μs	T _{JM}			@ T _{JM}		d.c. 180° sine		
	V	A	A	A ² s	μs	Q _{rr} μC	@ I _{TM} A	@ -di/dt A/μs	V	mΩ	K/W		
○ P0295WC12D	1200	295	2700	36.5 x 10 ³	20	50	300	20	1.600	1.230	0.0950	W8	
○ P0295WC12E	1200	295	2700	36.5 x 10 ³	25	50	300	20	1.600	1.230	0.0950	W8	
○ P0327WC08C	800	327	3250	63.9 x 10 ³	15	45	300	20	1.550	0.870	0.0950	W8	
○ P0327WC08D	800	327	3250	63.9 x 10 ³	20	45	300	20	1.550	0.870	0.0950	W8	
○ P0327WC08E	800	327	3250	63.9 x 10 ³	25	45	300	20	1.550	0.870	0.0950	W8	
○ P0327WC08F	800	327	3250	63.9 x 10 ³	30	45	300	20	1.550	0.870	0.0950	W8	
○ P0327WC12C	1200	327	3250	63.9 x 10 ³	15	45	300	20	1.550	0.870	0.0950	W8	
○ P0327WC12D	1200	327	3250	63.9 x 10 ³	20	45	300	20	1.550	0.870	0.0950	W8	
○ P0327WC12E	1200	327	3250	63.9 x 10 ³	25	45	300	20	1.550	0.870	0.0950	W8	
○ P0327WC12F	1200	327	3250	63.9 x 10 ³	30	45	300	20	1.550	0.870	0.0950	W8	
○ P0366WC04A	400	366	4700	110 x 10 ³	10	25	300	20	1.400	0.670	0.0950	W8	
○ P0366WC04B	400	366	4700	110 x 10 ³	12	25	300	20	1.400	0.670	0.0950	W8	
○ P0366WC04C	400	366	4700	110 x 10 ³	15	25	300	20	1.400	0.670	0.0950	W8	
○ P0366WC06A	600	366	4700	110 x 10 ³	10	25	300	20	1.400	0.670	0.0950	W8	
○ P0366WC06B	600	366	4700	110 x 10 ³	12	25	300	20	1.400	0.670	0.0950	W8	
○ P0366WC06C	600	366	4700	110 x 10 ³	15	25	300	20	1.400	0.670	0.0950	W8	
○ P0366WC08A	800	366	4700	110 x 10 ³	10	25	300	20	1.400	0.670	0.0950	W8	
○ P0366WC08B	800	366	4700	110 x 10 ³	12	25	300	20	1.400	0.670	0.0950	W8	
○ P0366WC08C	800	366	4700	110 x 10 ³	15	25	300	20	1.400	0.670	0.0950	W8	
○ P0367WC12E	1200	367	3600	64.8 x 10 ³	25	50	300	20	1.170	0.920	0.0950	W8	
○ P0367WC12F	1200	367	3600	64.8 x 10 ³	30	50	300	20	1.170	0.920	0.0950	W8	
○ P0389WC04B	400	389	5000	125 x 10 ³	12	30	300	20	1.050	0.880	0.0950	W8	
○ P0389WC04C	400	389	5000	125 x 10 ³	15	30	300	20	1.050	0.880	0.0950	W8	
○ P0389WC08B	800	389	5000	125 x 10 ³	12	30	300	20	1.050	0.880	0.0950	W8	
○ P0389WC08C	800	389	5000	125 x 10 ³	15	30	300	20	1.050	0.880	0.0950	W8	
○ P0515WC04B	400	515	6500	211 x 10 ³	12	180	300	20	0.950	0.377	0.0950	W8	
○ P0515WC04C	400	515	6500	211 x 10 ³	15	180	300	20	0.950	0.377	0.0950	W8	
○ P0515WC04D	400	515	6500	211 x 10 ³	20	180	300	20	0.950	0.377	0.0950	W8	
○ P0515WC06B	600	515	6500	211 x 10 ³	12	180	300	20	0.950	0.377	0.0950	W8	
○ P0515WC06C	600	515	6500	211 x 10 ³	15	180	300	20	0.950	0.377	0.0950	W8	
○ P0515WC06D	600	515	6500	211 x 10 ³	20	180	300	20	0.950	0.377	0.0950	W8	
○ P0838LC06B	600	1110	12300	750 x 10 ³	12	160	800	50	1.200	0.280	0.0320	W10	
○ P0838LC06C	600	1110	12300	750 x 10 ³	15	160	800	50	1.200	0.280	0.0320	W10	
○ P0838LC08B	800	1110	12300	750 x 10 ³	12	160	800	50	1.200	0.280	0.0320	W10	
○ P0838LC08C	800	1110	12300	750 x 10 ³	15	160	800	50	1.200	0.280	0.0320	W10	
○ P0848YC04B	400	848	8750	383 x 10 ³	12	200	550	40	1.010	0.305	0.0500	W58	
○ P0848YC04C	400	848	8750	383 x 10 ³	15	200	550	40	1.010	0.305	0.0500	W58	
○ P0848YC06B	600	848	8750	383 x 10 ³	12	200	550	40	1.010	0.305	0.0500	W58	
○ P0848YC06C	600	848	8750	383 x 10 ³	15	200	550	40	1.010	0.305	0.0500	W58	
○ P1007LC08D	800	1007	9500	451 x 10 ³	20	400	800	50	1.509	0.265	0.0320	W10	
○ P1007LC08E	800	1007	9500	451 x 10 ³	25	400	800	50	1.509	0.265	0.0320	W10	
○ P1007LC08F	800	1007	9500	451 x 10 ³	30	400	800	50	1.509	0.265	0.0320	W10	
○ P1007LC12D	1200	1007	9500	451 x 10 ³	20	400	800	50	1.509	0.265	0.0320	W10	
○ P1007LC12E	1200	1007	9500	451 x 10 ³	25	400	800	50	1.509	0.265	0.0320	W10	
○ P1007LC12F	1200	1007	9500	451 x 10 ³	30	400	800	50	1.509	0.265	0.0320	W10	

T_{JM} = 125°C



W8 Weight 70 g



W10 Weight 340 g

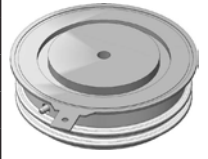

W58 Weight 90 g

Distributed Gate Thyristors

IXYS UK Westcode Ltd is recognised as the Worldwide leader in distributed gate technology. These devices are available with blocking voltages to 4.5kV and average currents in excess of 5kA, with tq ratings from 10µs. The unique distributed gate design and lifetime control features give these devices both high di/dt capability and fast, low recovery turn-off, while maintaining a low on-state voltage drop. Ideally suited to applications including: induction power supplies, high frequency inverters/converters, UPS and pulse power.

Capsule Types



Part No.	V _{DRM} V	V _{RRM} V	I _{TAV} A T _K = 55°C	I _{TSM} A	I ² t 10 ms ½ sine V _R - ≤ 60% V _{RRM} A ² s	t _q @ 200 V/µs µs	Typ. Reverse Recovery Charge			V _{TO} V	r _T @ T _{JM} mΩ	R _{thJK} 180° Sine K/W	Fig. No.	Package style Outlines on pages O-01...O-35
							Q _{rr} @ T _{JM} µC	@ I _{TM} A	@ -di/dt A/µs					
R0472YC12E	1200	1200	472	4300	92.5 x 10 ³	25	155	550	40	1.648	1.125	0.05000	W58	
R0472YC12F	1200	1200	472	4300	92.5 x 10 ³	30	155	550	40	1.648	1.125	0.05000	W58	
R0472YC16E	1600	1600	472	4300	92.5 x 10 ³	25	155	550	40	1.648	1.125	0.05000	W58	
R0472YC16F	1600	1600	472	4300	92.5 x 10 ³	30	155	550	40	1.648	1.125	0.05000	W58	
R0487YC12D	1200	1200	487	4300	92.5 x 10 ³	20	90	550	40	1.738	0.943	0.05000	W58	
R0487YC12E	1200	1200	487	4300	92.5 x 10 ³	25	90	550	40	1.738	0.943	0.05000	W58	
R0487YC14D	1400	1400	487	4300	92.5 x 10 ³	20	90	550	40	1.738	0.943	0.05000	W58	
R0487YC14E	1400	1400	487	4300	92.5 x 10 ³	25	90	550	40	1.738	0.943	0.05000	W58	
R0577YC12C	1200	1200	577	6000	180 x 10 ³	15	150	550	40	1.510	0.640	0.05000	W58	
R0577YC12D	1200	1200	577	6000	180 x 10 ³	20	150	550	40	1.510	0.640	0.05000	W58	
R0577YC12E	1200	1200	577	6000	180 x 10 ³	25	150	550	40	1.510	0.640	0.05000	W58	
R0633YC12D	1200	1200	633	6300	200 x 10 ³	20	125	550	40	1.250	0.614	0.05000	W58	
R0633YC12E	1200	1200	633	6300	200 x 10 ³	25	125	550	40	1.250	0.614	0.05000	W58	
R0633YC12F	1200	1200	633	6300	200 x 10 ³	30	125	550	40	1.250	0.614	0.05000	W58	
R0717LC14G	1400	1400	717	7050	248.5 x 10 ³	35	425	1000	60	1.752	0.732	0.03200	W10	
R0717LC14H	1400	1400	717	7050	248.5 x 10 ³	40	425	1000	60	1.752	0.732	0.03200	W10	
R0717LC16G	1600	1600	717	7050	248.5 x 10 ³	35	425	1000	60	1.752	0.732	0.03200	W10	
R0717LC16H	1600	1600	717	7050	248.5 x 10 ³	40	425	1000	60	1.752	0.732	0.03200	W10	
R0736LC20J	2000	2000	736	6800	231 x 10 ³	50	640	1000	60	1.842	0.619	0.03200	W10	
R0736LC20K	2000	2000	736	6800	231 x 10 ³	60	640	1000	60	1.842	0.619	0.03200	W10	
R0736LC22J	2200	2000	736	6800	231 x 10 ³	50	640	1000	60	1.842	0.619	0.03200	W10	
R0736LC22K	2200	2000	736	6800	231 x 10 ³	60	640	1000	60	1.842	0.619	0.03200	W10	
R0736LC25J	2500	2000	736	6800	231 x 10 ³	50	640	1000	60	1.842	0.619	0.03200	W10	
R0736LC25K	2500	2000	736	6800	231 x 10 ³	60	640	1000	60	1.842	0.619	0.03200	W10	
R0736LC25L	2500	2000	736	6800	231 x 10 ³	65	640	1000	60	1.842	0.619	0.03200	W10	
R0736LC25M	2500	2000	736	6800	231 x 10 ³	70	640	1000	60	1.842	0.619	0.03200	W10	
R0809LC10A	1000	1000	809	8000	320 x 10 ³	10	120	1000	60	2.100	0.300	0.03200	W10	
R0809LC10B	1000	1000	809	8000	320 x 10 ³	12	120	1000	60	2.100	0.300	0.03200	W10	
R0830LC12C	1200	1200	830	8500	361 x 10 ³	15	285	1000	60	1.900	0.357	0.03200	W10	
R0830LC12D	1200	1200	830	8500	361 x 10 ³	20	285	1000	60	1.900	0.357	0.03200	W10	
R0830LC12E	1200	1200	830	8500	361 x 10 ³	25	285	1000	60	1.900	0.357	0.03200	W10	
R0830LC12F	1200	1200	830	8500	361 x 10 ³	30	285	1000	60	1.900	0.357	0.03200	W10	
R0830LC14C	1400	1400	830	8500	361 x 10 ³	15	285	1000	60	1.900	0.357	0.03200	W10	
R0830LC14D	1400	1400	830	8500	361 x 10 ³	20	285	1000	60	1.900	0.357	0.03200	W10	
R0830LC14E	1400	1400	830	8500	361 x 10 ³	25	285	1000	60	1.900	0.357	0.03200	W10	
R0830LC14F	1400	1400	830	8500	361 x 10 ³	30	285	1000	60	1.900	0.357	0.03200	W10	
R0878LC18K	1800	1800	878	7500	281 x 10 ³	60	720	1000	60	1.447	0.480	0.03200	W10	
R0878LC18L	1800	1800	878	7500	281 x 10 ³	65	720	1000	60	1.447	0.480	0.03200	W10	
R0878LC18M	1800	1800	878	7500	281 x 10 ³	70	720	1000	60	1.447	0.480	0.03200	W10	
R0878LC20K	2000	1800	878	7500	281 x 10 ³	60	720	1000	60	1.447	0.480	0.03200	W10	
R0878LC20L	2000	1800	878	7500	281 x 10 ³	65	720	1000	60	1.447	0.480	0.03200	W10	
R0878LC20M	2000	1800	878	7500	281 x 10 ³	70	720	1000	60	1.447	0.480	0.03200	W10	
R0878LC21K	2100	1800	878	7500	281 x 10 ³	60	720	1000	60	1.447	0.480	0.03200	W10	
R0878LC21L	2100	1800	878	7500	281 x 10 ³	65	720	1000	60	1.447	0.480	0.03200	W10	
R0878LC21M	2100	1800	878	7500	281 x 10 ³	70	720	1000	60	1.447	0.480	0.03200	W10	
R0929LC12A	1200	1200	929	9000	405 x 10 ³	10	150	1000	60	1.549	0.350	0.03200	W10	
R0929LC12B	1200	1200	929	9000	405 x 10 ³	12	150	1000	60	1.549	0.350	0.03200	W10	
R0929LC12C	1200	1200	929	9000	405 x 10 ³	15	150	1000	60	1.549	0.350	0.03200	W10	
R0964LC10C	1000	1000	964	9400	442 x 10 ³	15	170	1000	60	1.530	0.309	0.03200	W10	
R0964LC10D	1000	1000	964	9400	442 x 10 ³	20	170	1000	60	1.530	0.309	0.03200	W10	
R0964LC10E	1000	1000	964	9400	442 x 10 ³	25	170	1000	60	1.530	0.309	0.03200	W10	
R0964LC12C	1200	1200	964	9400	442 x 10 ³	15	170	1000	60	1.530	0.309	0.03200	W10	
R0964LC12D	1200	1200	964	9400	442 x 10 ³	20	170	1000	60	1.530	0.309	0.03200	W10	
R0964LC12E	1200	1200	964	9400	442 x 10 ³	25	170	1000	60	1.530	0.309	0.03200	W10	

W10 Weight 340 g

W58 Weight 90 g



Distributed Gate Thyristors

Capsule Types

Part No.	V _{DRM}	V _{RRM}	I _{TAV}	I _{TSM}	I ² t	t _q	Typ. Reverse Recovery Charge			V _{TO}	r _T	R _{thJK}	Fig. No.	Package style
							@T _{JM}							
							Q _{rr}	@I _{TM}	@-di/dt					
	T _K = 55°C	10 ms ½ sine	@ 200 V/μs	V	mΩ	K/W								
○ Not for new design	V	V	A	A	A ² s	μs	μC	A	A/μs	V	mΩ	K/W		Outlines on pages O-01...O-35
➤ New	V	V	A	A	A ² s	μs	μC	A	A/μs	V	mΩ	K/W		
R0990LC08A	800	800	990	11000	605 x 10 ³	10	90	1000	60	1.350	0.350	0.03200	W10	
R0990LC08B	800	800	990	11000	605 x 10 ³	12	90	1000	60	1.350	0.350	0.03200	W10	
R0990LC08C	800	800	990	11000	605 x 10 ³	15	90	1000	60	1.350	0.350	0.03200	W10	
➤ R1045NC28L	2800	2800	1055	12500	781 x 10 ³	60	950	1000	60	1.640	0.430	0.02400	W11	 W10 Weight 340 g
➤ R1045NC28M	2800	2800	1055	12500	781 x 10 ³	70	950	1000	60	1.640	0.430	0.02400	W11	
➤ R1045NC32L	3200	3200	1055	12500	781 x 10 ³	60	950	1000	60	1.640	0.430	0.02400	W11	
➤ R1045NC32M	3200	3200	1055	12500	781 x 10 ³	70	950	1000	60	1.640	0.430	0.02400	W11	
R1124NC18J	1800	1800	1124	13500	0.91 x 10 ⁶	50	640	1000	60	1.540	0.379	0.02400	W11	
R1124NC18K	1800	1800	1124	13500	0.91 x 10 ⁶	60	640	1000	60	1.540	0.379	0.02400	W11	
R1124NC18L	1800	1800	1124	13500	0.91 x 10 ⁶	65	640	1000	60	1.540	0.379	0.02400	W11	
R1124NC18M	1800	1800	1124	13500	0.91 x 10 ⁶	70	640	1000	60	1.540	0.379	0.02400	W11	
R1124NC20J	2000	1800	1124	13500	0.91 x 10 ⁶	50	640	1000	60	1.540	0.379	0.02400	W11	
R1124NC20K	2000	1800	1124	13500	0.91 x 10 ⁶	60	640	1000	60	1.540	0.379	0.02400	W11	
R1124NC20L	2000	1800	1124	13500	0.91 x 10 ⁶	65	640	1000	60	1.540	0.379	0.02400	W11	
R1124NC20M	2000	1800	1124	13500	0.91 x 10 ⁶	70	640	1000	60	1.540	0.379	0.02400	W11	
R1124NC21J	2100	1800	1124	13500	0.91 x 10 ⁶	50	640	1000	60	1.540	0.379	0.02400	W11	
R1124NC21K	2100	1800	1124	13500	0.91 x 10 ⁶	60	640	1000	60	1.540	0.379	0.02400	W11	
R1124NC21L	2100	1800	1124	13500	0.91 x 10 ⁶	65	640	1000	60	1.540	0.379	0.02400	W11	
R1124NC21M	2100	1800	1124	13500	0.91 x 10 ⁶	70	640	1000	60	1.540	0.379	0.02400	W11	
R1127NC32P	3200	3200	1127	12800	819 x 10 ³	120	3500	1000	60	1.500	0.474	0.02200	W11	
R1127NC32R	3200	3200	1127	12800	819 x 10 ³	140	3500	1000	60	1.500	0.474	0.02200	W11	
R1127NC32S	3200	3200	1127	12800	819 x 10 ³	160	3500	1000	60	1.500	0.474	0.02200	W11	
R1127NC32T	3200	3200	1127	12800	819 x 10 ³	200	3500	1000	60	1.500	0.474	0.02200	W11	
R1127NC34R	3400	3400	1127	12800	819 x 10 ³	140	3500	1000	60	1.500	0.474	0.02200	W11	
R1127NC34S	3400	3400	1127	12800	819 x 10 ³	160	3500	1000	60	1.500	0.474	0.02200	W11	
R1127NC34T	3400	3400	1127	12800	819 x 10 ³	200	3500	1000	60	1.500	0.474	0.02200	W11	
R1127NC36R	3600	3600	1127	12800	819 x 10 ³	140	3500	1000	60	1.500	0.474	0.02200	W11	
R1127NC36S	3600	3600	1127	12800	819 x 10 ³	160	3500	1000	60	1.500	0.474	0.02200	W11	
R1127NC36T	3600	3600	1127	12800	819 x 10 ³	200	3500	1000	60	1.500	0.474	0.02200	W11	
R1158NC26N	2600	2600	1158	14500	1.05 x 10 ⁶	100	1600	1000	60	1.600	0.400	0.02200	W11	
R1158NC26P	2600	2600	1158	14500	1.05 x 10 ⁶	120	1600	1000	60	1.600	0.400	0.02200	W11	
R1158NC26T	2600	2600	1158	14500	1.05 x 10 ⁶	200	1600	1000	60	1.600	0.400	0.02200	W11	
R1178NC14E	1400	1400	1178	17000	1.45 x 10 ⁶	25	320	1000	60	1.600	0.300	0.02400	W11	
R1178NC14F	1400	1400	1178	17000	1.45 x 10 ⁶	30	320	1000	60	1.600	0.300	0.02400	W11	
R1178NC14G	1400	1400	1178	17000	1.45 x 10 ⁶	35	320	1000	60	1.600	0.300	0.02400	W11	
R1211NC12C	1200	1200	1211	17600	1.548 x 10 ⁶	15	230	1000	60	1.720	0.230	0.02400	W11	
R1211NC12D	1200	1200	1211	17600	1.548 x 10 ⁶	20	230	1000	60	1.720	0.230	0.02400	W11	
R1211NC12E	1200	1200	1211	17600	1.548 x 10 ⁶	25	230	1000	60	1.720	0.230	0.02400	W11	
R1271NC12B	1200	1200	1271	18000	1.62 x 10 ⁶	12	200	1000	60	1.547	0.237	0.02400	W11	
R1271NC12C	1200	1200	1271	18000	1.62 x 10 ⁶	15	200	1000	60	1.547	0.237	0.02400	W11	
R1271NC12D	1200	1200	1271	18000	1.62 x 10 ⁶	20	200	1000	60	1.547	0.237	0.02400	W11	
R1271NC12E	1200	1200	1271	18000	1.62 x 10 ⁶	25	200	1000	60	1.547	0.237	0.02400	W11	
R1275NC18L	1800	1800	1275	15500	1.20 x 10 ⁶	65	940	1000	60	1.207	0.342	0.02400	W11	
R1275NC18M	1800	1800	1275	15500	1.20 x 10 ⁶	70	940	1000	60	1.207	0.342	0.02400	W11	
R1275NC20L	2000	1800	1275	15500	1.20 x 10 ⁶	65	940	1000	60	1.207	0.342	0.02400	W11	
R1275NC20M	2000	1800	1275	15500	1.20 x 10 ⁶	70	940	1000	60	1.207	0.342	0.02400	W11	
R1275NC21L	2100	1800	1275	15500	1.20 x 10 ⁶	65	940	1000	60	1.207	0.342	0.02400	W11	
R1275NC21M	2100	1800	1275	15500	1.20 x 10 ⁶	70	940	1000	60	1.207	0.342	0.02400	W11	
○ R1279NC22J	2200	2200	1279	14800	1.10 x 10 ⁶	50	1250	1000	60	1.440	0.330	0.02200	W11	
○ R1279NC22K	2200	2200	1279	14800	1.10 x 10 ⁶	60	1250	1000	60	1.440	0.330	0.02200	W11	
○ R1279NC22L	2200	2200	1279	14800	1.10 x 10 ⁶	65	1250	1000	60	1.440	0.330	0.02200	W11	
○ R1279NC22M	2200	2200	1279	14800	1.10 x 10 ⁶	70	1250	1000	60	1.440	0.330	0.02200	W11	
○ R1279NC25J	2500	2500	1279	14800	1.10 x 10 ⁶	50	1250	1000	60	1.440	0.330	0.02200	W11	
○ R1279NC25K	2500	2500	1279	14800	1.10 x 10 ⁶	60	1250	1000	60	1.440	0.330	0.02200	W11	
○ R1279NC25L	2500	2500	1279	14800	1.10 x 10 ⁶	65	1250	1000	60	1.440	0.330	0.02200	W11	
○ R1279NC25M	2500	2500	1279	14800	1.10 x 10 ⁶	70	1250	1000	60	1.440	0.330	0.02200	W11	





Distributed Gate Thyristors

Capsule Types

Part No.	V _{DRM} V	V _{RRM} V	I _{TAV} A T _K = 55°C	I _{TSM} A	I ² t 10 ms ½ sine V _R - ≤ 60% V _{RRM} A ² s	t _q @ 200 V/μs μs	Typ. Reverse Recovery Charge			V _{TO} @ T _{JM} V		r _T mΩ	R _{thJK} 180° Sine K/W	Fig. No.	Package style Outlines on pages O-01...O-35
							Q _{rr} μC	@ T _{JM} @ I _{TM} A	@ -di/dt A/μs						
○ R1280NC21J	2100	2100	1280	14800	1.10 x 10 ⁶	50	1200	1000	60	1.440	0.330	0.02200	W11		
○ R1280NC21K	2100	2100	1280	14800	1.10 x 10 ⁶	60	1200	1000	60	1.440	0.330	0.02200	W11		
○ R1280NC21L	2100	2100	1280	14800	1.10 x 10 ⁶	65	1200	1000	60	1.440	0.330	0.02200	W11		
○ R1280NC21M	2100	2100	1280	14800	1.10 x 10 ⁶	70	1200	1000	60	1.440	0.330	0.02200	W11		
○ R1280NC22J	2200	2100	1280	14800	1.10 x 10 ⁶	50	1200	1000	60	1.440	0.330	0.02200	W11		
○ R1280NC22K	2200	2100	1280	14800	1.10 x 10 ⁶	60	1200	1000	60	1.440	0.330	0.02200	W11		
○ R1280NC22L	2200	2100	1280	14800	1.10 x 10 ⁶	65	1200	1000	60	1.440	0.330	0.02200	W11		
○ R1280NC22M	2200	2100	1280	14800	1.10 x 10 ⁶	70	1200	1000	60	1.440	0.330	0.02200	W11		
○ R1280NC25J	2500	2100	1280	14800	1.10 x 10 ⁶	50	1200	1000	60	1.440	0.330	0.02200	W11		
○ R1280NC25K	2500	2100	1280	14800	1.10 x 10 ⁶	60	1200	1000	60	1.440	0.330	0.02200	W11		
○ R1280NC25L	2500	2100	1280	14800	1.10 x 10 ⁶	65	1200	1000	60	1.440	0.330	0.02200	W11		
○ R1280NC25M	2500	2100	1280	14800	1.10 x 10 ⁶	70	1200	1000	60	1.440	0.330	0.02200	W11		
○ R1331NC10B	1000	1000	1331	18200	1.66 x 10 ⁶	12	200	1000	60	1.450	0.285	0.02200	W11	 W11 Weight 510 g	
○ R1331NC10C	1000	1000	1331	18200	1.66 x 10 ⁶	15	200	1000	60	1.450	0.285	0.02200	W11		
○ R1331NC10D	1000	1000	1331	18200	1.66 x 10 ⁶	20	200	1000	60	1.450	0.285	0.02200	W11		
○ R1331NC12B	1200	1200	1331	18200	1.66 x 10 ⁶	12	200	1000	60	1.450	0.285	0.02200	W11		
○ R1331NC12C	1200	1200	1331	18200	1.66 x 10 ⁶	15	200	1000	60	1.450	0.285	0.02200	W11		
○ R1331NC12D	1200	1200	1331	18200	1.66 x 10 ⁶	20	200	1000	60	1.450	0.285	0.02200	W11		
R1446NC12C	1200	1200	1446	19500	1.90 x 10 ⁶	15	300	1000	60	1.304	0.199	0.02400	W11		
R1446NC12D	1200	1200	1446	19500	1.90 x 10 ⁶	20	300	1000	60	1.304	0.199	0.02400	W11		
R1446NC12E	1200	1200	1446	19500	1.90 x 10 ⁶	25	300	1000	60	1.304	0.199	0.02400	W11		
R1446NC12F	1200	1200	1446	19500	1.90 x 10 ⁶	30	300	1000	60	1.304	0.199	0.02400	W11		
○ R1448NC14H	1400	1400	1448	15500	1.20 x 10 ⁶	40	950	1000	60	1.300	0.250	0.02200	W11		
○ R1448NC14J	1400	1400	1448	15500	1.20 x 10 ⁶	50	950	1000	60	1.300	0.250	0.02200	W11		
○ R1448NC18H	1800	1800	1448	15500	1.20 x 10 ⁶	40	950	1000	60	1.300	0.250	0.02200	W11		
○ R1448NC18J	1800	1800	1448	15500	1.20 x 10 ⁶	50	950	1000	60	1.300	0.250	0.02200	W11		
○ R1448NC20H	2000	2000	1448	15500	1.20 x 10 ⁶	40	950	1000	60	1.300	0.250	0.02200	W11		
○ R1448NC20J	2000	2000	1448	15500	1.20 x 10 ⁶	50	950	1000	60	1.300	0.250	0.02200	W11		
○ R1448NC20K	2000	2000	1448	15500	1.20 x 10 ⁶	60	950	1000	60	1.300	0.250	0.02200	W11		
○ R1448NC20L	2000	2000	1448	15500	1.20 x 10 ⁶	65	950	1000	60	1.300	0.250	0.02200	W11		
○ R1448NC20M	2000	2000	1448	15500	1.20 x 10 ⁶	70	950	1000	60	1.300	0.250	0.02200	W11		
R1605MC20E	2000	2000	1605	20700	2.14 x 10 ⁶	25	900	1000	60	2.100	0.200	0.01500	W70	 W70 Weight 550 g	
R1605MC20F	2000	2000	1605	20700	2.14 x 10 ⁶	30	900	1000	60	2.100	0.200	0.01500	W70		
R1605MC20G	2000	2000	1605	20700	2.14 x 10 ⁶	35	900	1000	60	2.100	0.200	0.01500	W70		
R1605MC20H	2000	2000	1605	20700	2.14 x 10 ⁶	40	900	1000	60	2.100	0.200	0.01500	W70		
R1605MC20J	2000	2000	1605	20700	2.14 x 10 ⁶	50	900	1000	60	2.100	0.200	0.01500	W70		
R1605MC22E	2200	2200	1605	20700	2.14 x 10 ⁶	25	900	1000	60	2.100	0.200	0.01500	W70		
R1605MC22F	2200	2200	1605	20700	2.14 x 10 ⁶	30	900	1000	60	2.100	0.200	0.01500	W70		
R1605MC22G	2200	2200	1605	20700	2.14 x 10 ⁶	35	900	1000	60	2.100	0.200	0.01500	W70		
R1605MC22H	2200	2200	1605	20700	2.14 x 10 ⁶	40	900	1000	60	2.100	0.200	0.01500	W70		
R1605MC22J	2200	2200	1605	20700	2.14 x 10 ⁶	50	900	1000	60	2.100	0.200	0.01500	W70		
R1700MC18E	1800	1800	1700	20000	2.0 x 10 ⁶	25	1400	1000	60	1.600	0.250	0.01500	W70		
R1700MC18F	1800	1800	1700	20000	2.0 x 10 ⁶	30	1400	1000	60	1.600	0.250	0.01500	W70		
R1700MC18G	1800	1800	1700	20000	2.0 x 10 ⁶	35	1400	1000	60	1.600	0.250	0.01500	W70		
R1700MC18H	1800	1800	1700	20000	2.0 x 10 ⁶	40	1400	1000	60	1.600	0.250	0.01500	W70		
R1700MC18J	1800	1800	1700	20000	2.0 x 10 ⁶	50	1400	1000	60	1.600	0.250	0.01500	W70		
R1700MC21E	2100	1800	1700	20000	2.0 x 10 ⁶	25	1400	1000	60	1.600	0.250	0.01500	W70		
R1700MC21F	2100	1800	1700	20000	2.0 x 10 ⁶	30	1400	1000	60	1.600	0.250	0.01500	W70		
R1700MC21G	2100	1800	1700	20000	2.0 x 10 ⁶	35	1400	1000	60	1.600	0.250	0.01500	W70		
R1700MC21H	2100	1800	1700	20000	2.0 x 10 ⁶	40	1400	1000	60	1.600	0.250	0.01500	W70		
R1700MC21J	2100	1800	1700	20000	2.0 x 10 ⁶	50	1400	1000	60	1.600	0.250	0.01500	W70		

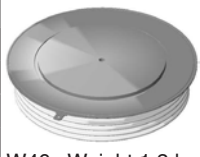
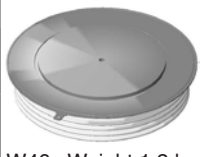
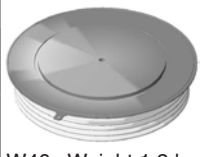
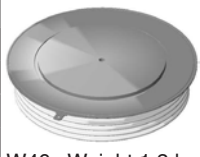
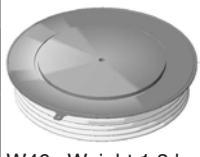
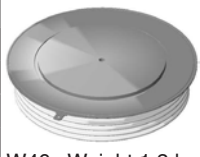
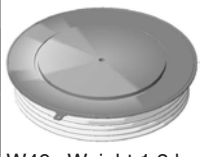
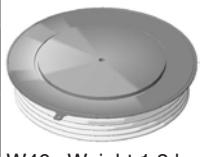
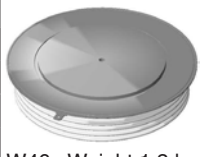
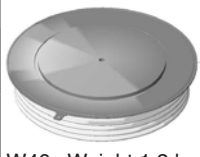
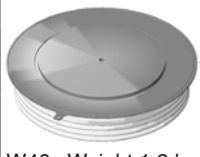

Distributed Gate Thyristors

Capsule Types

Part No.	V _{DRM}	V _{RRM}	I _{TAV}	I _{TSM}	I ² t	t _q	Typ. Reverse Recovery Charge			V _{TO}	r _T	R _{thJK}	Fig. No.	Package style
							Q _{rr}	@ T _{JM}	@ -di/dt					
➤ New	V	V	A	A	A ² s	μs	μC	A	A/μs	V	mΩ	K/W		Outlines on pages O-01...O-35
R1955MC14D	1400	1400	1955	26500	3.51×10 ⁶	20	1000	1000	60	1.460	0.910	0.01500	W70	
R1955MC14E	1400	1400	1955	26500	3.51×10 ⁶	25	1000	1000	60	1.460	0.910	0.01500	W70	
R1955MC14F	1400	1400	1955	26500	3.51×10 ⁶	30	1000	1000	60	1.460	0.910	0.01500	W70	
R1955MC16D	1600	1600	1955	26500	3.51 x 10 ⁶	20	1000	1000	60	1.460	0.910	0.01500	W70	
R1955MC16E	1600	1600	1955	26500	3.51 x 10 ⁶	25	1000	1000	60	1.460	0.910	0.01500	W70	
R1955MC16F	1600	1600	1955	26500	3.51 x 10 ⁶	30	1000	1000	60	1.460	0.910	0.01500	W70	
R2075MC12A	1200	1200	2075	29000	4.21 x 10 ⁶	10	300	1000	60	1.390	0.167	0.01500	W70	
R2075MC12B	1200	1200	2075	29000	4.21 x 10 ⁶	12	300	1000	60	1.390	0.167	0.01500	W70	
R2075MC12C	1200	1200	2075	29000	4.21 x 10 ⁶	15	300	1000	60	1.390	0.167	0.01500	W70	
➤ R2295HA22F	2200	2200	2295	30000	4.50 x 10 ⁶	30	875	1000	60	1.690	0.190	0.01100	W79	
➤ R2295HA22H	2200	2200	2295	30000	4.50 x 10 ⁶	40	875	1000	60	1.690	0.190	0.01100	W79	
R2475ZC28M	2800	2800	2475	31000	4.81 x 10 ⁶	70	3900	4000	60	1.504	0.174	0.01100	W13	W13 Weight 1.7 kg
R2475ZC28N	2800	2800	2475	31000	4.81 x 10 ⁶	100	3900	4000	60	1.504	0.174	0.01100	W13	
R2475ZC28R	2800	2800	2475	31000	4.81 x 10 ⁶	140	3900	4000	60	1.504	0.174	0.01100	W13	
R2475ZD28M	2800	2800	2475	31000	4.81 x 10 ⁶	70	3900	4000	60	1.504	0.174	0.01100	W46	
R2475ZD28N	2800	2800	2475	31000	4.81 x 10 ⁶	100	3900	4000	60	1.504	0.174	0.01100	W46	
R2475ZD28R	2800	2800	2475	31000	4.81 x 10 ⁶	140	3900	4000	60	1.504	0.174	0.01100	W46	
R2619ZC18J	1800	1800	2619	33800	5.71 x 10 ⁶	50	1850	4000	60	1.308	0.173	0.01100	W13	
R2619ZC18K	1800	1800	2619	33800	5.71 x 10 ⁶	60	1850	4000	60	1.308	0.173	0.01100	W13	
R2619ZC18L	1800	1800	2619	33800	5.71 x 10 ⁶	65	1850	4000	60	1.308	0.173	0.01100	W13	
R2619ZC20J	2000	2000	2619	33800	5.71 x 10 ⁶	50	1850	4000	60	1.308	0.173	0.01100	W13	
R2619ZC20K	2000	2000	2619	33800	5.71 x 10 ⁶	60	1850	4000	60	1.308	0.173	0.01100	W13	
R2619ZC20L	2000	2000	2619	33800	5.71 x 10 ⁶	65	1850	4000	60	1.308	0.173	0.01100	W13	
R2619ZC21J	2100	2100	2619	33800	5.71 x 10 ⁶	50	1850	4000	60	1.308	0.173	0.01100	W13	
R2619ZC21K	2100	2100	2619	33800	5.71 x 10 ⁶	60	1850	4000	60	1.308	0.173	0.01100	W13	
R2619ZC21L	2100	2100	2619	33800	5.71 x 10 ⁶	65	1850	4000	60	1.308	0.173	0.01100	W13	
R2619ZC25J	2500	2100	2619	33800	5.71 x 10 ⁶	50	1850	4000	60	1.308	0.173	0.01100	W13	W46 Weight 1.2 kg
R2619ZC25K	2500	2100	2619	33800	5.71 x 10 ⁶	60	1850	4000	60	1.308	0.173	0.01100	W13	
R2619ZC25L	2500	2100	2619	33800	5.71 x 10 ⁶	65	1850	4000	60	1.308	0.173	0.01100	W13	
R2619ZD18J	1800	1800	2619	33800	5.71 x 10 ⁶	50	1850	4000	60	1.308	0.173	0.01100	W46	
R2619ZD18K	1800	1800	2619	33800	5.71 x 10 ⁶	60	1850	4000	60	1.308	0.173	0.01100	W46	
R2619ZD18L	1800	1800	2619	33800	5.71 x 10 ⁶	65	1850	4000	60	1.308	0.173	0.01100	W46	
R2619ZD20J	2000	2000	2619	33800	5.71 x 10 ⁶	50	1850	4000	60	1.308	0.173	0.01100	W46	
R2619ZD20K	2000	2000	2619	33800	5.71 x 10 ⁶	60	1850	4000	60	1.308	0.173	0.01100	W46	
R2619ZD20L	2000	2000	2619	33800	5.71 x 10 ⁶	65	1850	4000	60	1.308	0.173	0.01100	W46	
R2619ZD21J	2100	2100	2619	33800	5.71 x 10 ⁶	50	1850	4000	60	1.308	0.173	0.01100	W46	
R2619ZD21K	2100	2100	2619	33800	5.71 x 10 ⁶	60	1850	4000	60	1.308	0.173	0.01100	W46	
R2619ZD21L	2100	2100	2619	33800	5.71 x 10 ⁶	65	1850	4000	60	1.308	0.173	0.01100	W46	
R2619ZD25J	2500	2100	2619	33800	5.71 x 10 ⁶	50	1850	4000	60	1.308	0.173	0.01100	W46	
R2619ZD25K	2500	2100	2619	33800	5.71 x 10 ⁶	60	1850	4000	60	1.308	0.173	0.01100	W46	
R2619ZD25L	2500	2100	2619	33800	5.71 x 10 ⁶	65	1850	4000	60	1.308	0.173	0.01100	W46	
R2620ZC22J	2200	2200	2620	33800	5.71 x 10 ⁶	50	2100	4000	60	1.500	0.143	0.01100	W13	
R2620ZC22K	2200	2200	2620	33800	5.71 x 10 ⁶	60	2100	4000	60	1.500	0.143	0.01100	W13	
R2620ZC22L	2200	2200	2620	33800	5.71 x 10 ⁶	65	2100	4000	60	1.500	0.143	0.01100	W13	
R2620ZC25J	2500	2500	2620	33800	5.71 x 10 ⁶	50	2100	4000	60	1.500	0.143	0.01100	W13	W70 Weight 550 g
R2620ZC25K	2500	2500	2620	33800	5.71 x 10 ⁶	60	2100	4000	60	1.500	0.143	0.01100	W13	
R2620ZC25L	2500	2500	2620	33800	5.71 x 10 ⁶	65	2100	4000	60	1.500	0.143	0.01100	W13	
R2620ZD22J	2200	2200	2620	33800	5.71 x 10 ⁶	50	2100	4000	60	1.500	0.143	0.01100	W46	
R2620ZD22K	2200	2200	2620	33800	5.71 x 10 ⁶	60	2100	4000	60	1.500	0.143	0.01100	W46	
R2620ZD22L	2200	2200	2620	33800	5.71 x 10 ⁶	65	2100	4000	60	1.500	0.143	0.01100	W46	
R2620ZD25J	2500	2500	2620	33800	5.71 x 10 ⁶	50	2100	4000	60	1.500	0.143	0.01100	W46	
R2620ZD25K	2500	2500	2620	33800	5.71 x 10 ⁶	60	2100	4000	60	1.500	0.143	0.01100	W46	
R2620ZD25L	2500	2500	2620	33800	5.71 x 10 ⁶	65	2100	4000	60	1.500	0.143	0.01100	W46	

Distributed Gate Thyristors

Capsule Types

Part No.	V _{DRM}	V _{RRM}	I _{TAV}	I _{TSM}	I ² t	t _q	Typ. Reverse Recovery Charge			V _{TO}	r _T	R _{thJK}	Fig. No.	Package style
							Q _{rr}	@ I _{TM}	@ -di/dt					
○ Not for new design ➤ New	V	V	A	A	A ² s	μs	μC	A	A/μs	V	mΩ	K/W		Outlines on pages O-01...O-35
R2714ZC14H	1400	1400	2714	35600	6.34 x 10 ⁶	40	1400	4000	60	1.250	0.163	0.01100	W13	  W13 Weight 1.7 kg
R2714ZC14J	1400	1400	2714	35600	6.34 x 10 ⁶	50	1400	4000	60	1.250	0.163	0.01100	W13	
R2714ZC14K	1400	1400	2714	35600	6.34 x 10 ⁶	60	1400	4000	60	1.250	0.163	0.01100	W13	
R2714ZC18H	1800	1800	2714	35600	6.34 x 10 ⁶	40	1400	4000	60	1.250	0.163	0.01100	W13	
R2714ZC18J	1800	1800	2714	35600	6.34 x 10 ⁶	50	1400	4000	60	1.250	0.163	0.01100	W13	
R2714ZC18K	1800	1800	2714	35600	6.34 x 10 ⁶	60	1400	4000	60	1.250	0.163	0.01100	W13	
R2714ZD14H	1400	1400	2714	35600	6.34 x 10 ⁶	40	1400	4000	60	1.250	0.163	0.01100	W46	
R2714ZD14J	1400	1400	2714	35600	6.34 x 10 ⁶	50	1400	4000	60	1.250	0.163	0.01100	W46	
R2714ZD14K	1400	1400	2714	35600	6.34 x 10 ⁶	60	1400	4000	60	1.250	0.163	0.01100	W46	
R2714ZD18H	1800	1800	2714	35600	6.34 x 10 ⁶	40	1400	4000	60	1.250	0.163	0.01100	W46	
R2714ZD18J	1800	1800	2714	35600	6.34 x 10 ⁶	50	1400	4000	60	1.250	0.163	0.01100	W46	
R2714ZD18K	1800	1800	2714	35600	6.34 x 10 ⁶	60	1400	4000	60	1.250	0.163	0.01100	W46	
○ R3047TC24K	2400	2400	3047	50000	12.5 x 10 ⁶	60	2100	4000	60	1.580	0.170	0.00800	W14	
○ R3047TC24M	2400	2400	3047	50000	12.5 x 10 ⁶	70	2100	4000	60	1.580	0.170	0.00800	W14	
○ R3047TC24N	2400	2400	3047	50000	12.5 x 10 ⁶	100	2100	4000	60	1.580	0.170	0.00800	W14	
○ R3047TC28K	2800	2800	3047	50000	12.5 x 10 ⁶	60	2100	4000	60	1.580	0.170	0.00800	W14	
○ R3047TC28M	2800	2800	3047	50000	12.5 x 10 ⁶	70	2100	4000	60	1.580	0.170	0.00800	W14	
○ R3047TC28N	2800	2800	3047	50000	12.5 x 10 ⁶	100	2100	4000	60	1.580	0.170	0.00800	W14	
➤ R3115TJ24J	2400	2400	3115	56000	15.68 x 10 ⁶	50	3350	2000	60	1.884	0.120	0.00800	W81	
➤ R3115TJ24K	2400	2400	3115	56000	15.68 x 10 ⁶	60	3350	2000	60	1.884	0.120	0.00800	W81	
➤ R3115TJ28J	2800	2800	3115	56000	15.68 x 10 ⁶	50	3350	2000	60	1.884	0.120	0.00800	W81	
➤ R3115TJ28K	2800	2800	3115	56000	15.68 x 10 ⁶	60	3350	2000	60	1.884	0.120	0.00800	W81	
R3370ZC12C	1200	1200	3370	43900	9.64 x 10 ⁶	15	600	4000	60	1.353	0.064	0.01100	W13	
R3370ZC12D	1200	1200	3370	43900	9.64 x 10 ⁶	20	600	4000	60	1.353	0.064	0.01100	W13	
R3370ZC12E	1200	1200	3370	43900	9.64 x 10 ⁶	25	600	4000	60	1.353	0.064	0.01100	W13	
R3370ZD12C	1200	1200	3370	43900	9.64 x 10 ⁶	15	600	4000	60	1.353	0.064	0.01100	W46	
R3370ZD12D	1200	1200	3370	43900	9.64 x 10 ⁶	20	600	4000	60	1.353	0.064	0.01100	W46	
R3370ZD12E	1200	1200	3370	43900	9.64 x 10 ⁶	25	600	4000	60	1.353	0.064	0.01100	W46	
○ R3559TC20K	2000	2000	3559	38900	7.57 x 10 ⁶	60	1750	4000	60	1.173	0.155	0.00800	W14	
○ R3559TC20M	2000	2000	3559	38900	7.57 x 10 ⁶	70	1750	4000	60	1.173	0.155	0.00800	W14	
○ R3559TC20N	2000	2000	3559	38900	7.57 x 10 ⁶	100	1750	4000	60	1.173	0.155	0.00800	W14	
○ R3968FC24K	2400	2400	4001	66000	21.78 x 10 ⁶	60	2600	4000	60	1.453	0.125	0.00650	W15	
○ R3968FC24M	2400	2400	4001	66000	21.78 x 10 ⁶	70	2600	4000	60	1.453	0.125	0.00650	W15	
○ R3968FC24N	2400	2400	4001	66000	21.78 x 10 ⁶	100	2600	4000	60	1.453	0.125	0.00650	W15	
○ R3968FC28K	2800	2800	4001	66000	21.78 x 10 ⁶	60	2600	4000	60	1.453	0.125	0.00650	W15	
○ R3968FC28M	2800	2800	4001	66000	21.78 x 10 ⁶	70	2600	4000	60	1.453	0.125	0.00650	W15	
○ R3968FC28N	2800	2800	4001	66000	21.78 x 10 ⁶	100	2600	4000	60	1.453	0.125	0.00650	W15	
➤ R4680EA24K	2400	2400	4680	67000	22.40 x 10 ⁶	60	3000	1000	60	1.509	0.128	0.00500	W107	
➤ R4680EA24L	2400	2400	4680	67000	22.40 x 10 ⁶	65	3000	1000	60	1.509	0.128	0.00500	W107	
➤ R4680EA24M	2400	2400	4680	67000	22.40 x 10 ⁶	70	3000	1000	60	1.509	0.128	0.00500	W107	
➤ R4680EA28K	2800	2800	4680	67000	22.40 x 10 ⁶	60	3000	1000	60	1.509	0.128	0.00500	W107	
➤ R4680EA28L	2800	2800	4680	67000	22.40 x 10 ⁶	65	3000	1000	60	1.509	0.128	0.00500	W107	
➤ R4680EA28M	2800	2800	4680	67000	22.40 x 10 ⁶	70	3000	1000	60	1.509	0.128	0.00500	W107	
➤ R5145FA42V	4200	4500	5145	66000	21.78 x 10 ⁶	250	12000	4000	60	1.659	0.107	0.00450	W118	
➤ R5145FA42W	4200	4500	5145	66000	21.78 x 10 ⁶	300	12000	4000	60	1.659	0.107	0.00450	W118	
➤ R5145FA45V	4500	4500	5145	66000	21.78 x 10 ⁶	250	12000	4000	60	1.659	0.107	0.00450	W118	
➤ R5145FA45W	4500	4500	5145	66000	21.78 x 10 ⁶	300	12000	4000	60	1.659	0.107	0.00450	W118	
➤ R5370EA18J	1800	1800	5370	70000	24.5 x 10 ⁶	50	3000	1000	60	1.661	0.071	0.00500	W107	
➤ R5370EA18K	1800	1800	5370	70000	24.5 x 10 ⁶	60	3000	1000	60	1.661	0.071	0.00500	W107	
➤ R5370EA22J	2200	2200	5370	70000	24.5 x 10 ⁶	50	3000	1000	60	1.661	0.071	0.00500	W107	
➤ R5370EA22K	2200	2200	5370	70000	24.5 x 10 ⁶	60	3000	1000	60	1.661	0.071	0.00500	W107	

W107 Weight 1.6 kg

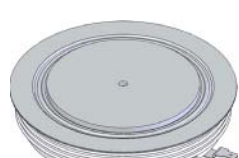
W81 Weight 1.2 kg

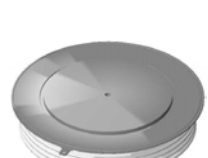
W46 Weight 1.2 kg

Distributed Gate Thyristors

Asymmetric Thyristors

These devices are available up to a voltage of 2800V. They exhibit very fast turn-on times and are capable of very high values of both critical di/dt and dv/dt. For the device type, they also exhibit high current ratings in excess of 1000A. Asymmetric construction optimizes the forward losses against the turn-off losses and gives the best performance in their voltage class.

Part No.	V_{DRM}	V_{RRM}	I_{TAV}	I_{TSM}	I^2t	t_{gd}	typ. t_q	$(di/dt)_{cr}$	$(dv/dt)_{cr}$	V_{TO}	r_T	T_{JM}	R_{thJK}	Fig. No.
	V	V	$T_K = 55^\circ C$ A	A	10 ms $\frac{1}{2}$ sine A^2s	25°C typ. μs	@ 200 V/ μs μC	@ T_{JM} A/ μs	@ T_{JM} V/ μs	@ T_{JM} V m Ω		°C	180° Sine K/W	
A0516YC240	2400	10	516	5700	151×10^3	0.5	55	2000	3000	1.630	0.850	125	0.0500	W58
A0516YC280	2800	10	516	5700	151×10^3	0.5	55	2000	3000	1.630	0.850	125	0.0500	W58
A1237NC240	2400	30	1237	18000	1.62×10^6	0.9	30	2000	3000	1.707	0.212	125	0.0240	W11
A1237NC280	2800	30	1237	18000	1.62×10^6	0.9	30	2000	3000	1.707	0.212	125	0.0240	W11

Outlines on pages O-01...O-35



W11 Weight 510 g

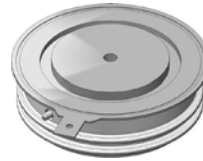

W58 Weight 90 g

Pulse Thyristors

IXYS UK Westcode Ltd are at the forefront of solid state pulsed power technology, offering custom solutions to complex pulsed power problems.

Standard Devices with voltage ratings to 2.5kV, pulsed currents to 150kA peak and di/dt capabilities to over 30kA/ μs are available. Please consult factory for other requirements for voltage ratings up to 4.5kV and pulsed current ratings >200kA

Part No.	V_{DRM}	V_{RRM}	V_{DC}	I_{PULSE}	$(di/dt)_{cr}$	V_{TO}	r_T	T_{JM}	R_{thJC}	Fig. No.	Package style
	$V_{GK} = 2 V$ V	V	$V_{GK} = 2 V$ V	kA	kA/ μs	@ T_{JM} V m Ω		°C	180° Sine K/W		
Y200CKC250	2500	2000	1500	20	5	1.216	2.20	125	0.065	W34	Outlines on pages O-01...O-35
Y500CNC250	2500	2000	1500	50	11	1.755	1.12	125	0.027	W36	



W34 Weight 120 g



W36 Weight 500 g

Gate Turn Off Thyristors

IXYS UK offers a broad range of high specification devices with voltage ratings to 4.5kV (2.8kV DC link) and controllable current ratings of up to 4kA are available to meet the toughest demands in applications such as traction propulsion and auxiliaries, AC industrial drives, FACT's and active VAr controllers. Offering both symmetrical devices for applications with a reverse blocking requirement e.g. current sourced inverters and asymmetric blocking devices for applications where no reverse blocking requirement exists e.g. voltage sourced inverters.

Gate Turn-off Thyristors are still the component of choice when it comes to very high power converters and we remain totally committed to this technology for the foreseeable future with an active program for continued product improvement.

Part No.	V _{DRM} V _{GK} = -2V V	V _{RRM} V	I _{TGQM} @ C _s		I _{TAV} T _K = 55°C A	I _{TSM} kA	I ² t 10 ms ½ sine V _R ≤ 10 V kA ² s	Typ. Switching Times		V _T I _T = I _{TGQM} V	T _{JM} °C	R _{thJK} 180° Sine K/W	Fig. No.
			A	µC				t _{gt} µs	t _{qs} µs				
➤ G1000NC45B	4500	18	1000	2.0	545	8.00	320 × 10 ³	3.5	15	4.0	125	0.0270	W36
G1000QC25B	2500	18	1000	1.0	615	8.00	320 × 10 ³	2.8	13	2.5	125	0.0380	W35
G1000QC45B	4500	18	1000	1.0	443	6.50	211 × 10 ³	3.4	14	4.0	125	0.0380	W35
G2000HF250	2500	18	2000	4.0	1030	16.00	1.28 × 10 ⁶	3.0	25	2.8	125	0.0220	W85
G2000HF450	4500	18	2000	4.0	890	13.70	938 × 10 ³	4.0	25	3.5	125	0.0220	W85
G2500HF250	2500	18	2500	6.0	1085	16.00	1.28 × 10 ⁶	3.0	25	3.1	125	0.0200	W85
G3000TF250	2500	18	3000	5.0	1690	30.00	4.5 × 10 ⁶	3.5	26	2.5	125	0.0120	W86
G3000TF450	4500	18	3000	6.0	1381	24.00	2.88 × 10 ⁶	4.0	22	4.0	125	0.0120	W86
➤ G4000EF250	2500	18	4000	6.0	2005	32.00	5.12 × 10 ⁶	4.5	28	3.0	125	0.0110	W104
G4000EF450	4500	18	4000	6.0	1480	26.00	3.38 × 10 ⁶	4.0	30	4.4	125	0.0110	W104
H0500KC200	2000	2000	500	1.0	280	3.00	45 × 10 ³	2.0	5	3.2	125	0.0650	W34
H0500KC20Y	2000	100	500	1.0	280	3.00	45 × 10 ³	2.0	5	3.2	125	0.0650	W34
H0500KC25D	2500	2000	500	1.0	280	3.00	45 × 10 ³	2.0	5	3.2	125	0.0650	W34
H0500KC25Y	2500	100	500	1.0	280	3.00	45 × 10 ³	2.0	5	3.2	125	0.0650	W34
H0700KC140	1400	1400	700	1.5	360	4.00	80 × 10 ³	3.0	5	2.8	125	0.0630	W34
H0700KC14Y	1400	100	700	1.5	360	4.00	80 × 10 ³	3.0	5	2.8	125	0.0630	W34
H0700KC17D	1700	1400	700	1.5	360	4.00	80 × 10 ³	3.0	5	2.8	125	0.0630	W34
H0700KC17Y	1700	100	700	1.5	360	4.00	80 × 10 ³	3.0	5	2.8	125	0.0630	W34
H1200NC200	2000	2000	1200	3.0	670	10.50	550 × 10 ³	3.0	12	3.3	125	0.0270	W36
H1200NC20Y	2000	100	1200	3.0	670	10.50	550 × 10 ³	3.0	12	3.3	125	0.0270	W36
H1200NC25D	2500	2000	1200	3.0	670	10.50	550 × 10 ³	3.0	12	3.3	125	0.0270	W36
H1200NC25Y	2500	100	1200	3.0	670	10.50	550 × 10 ³	3.0	12	3.3	125	0.0270	W36
S0300SR12Y	1200	100	480	1.0	215	3.50	61.2 × 10 ³	3.5	9	2.4	125	0.1300	W87
S0500YC20Y	2000	100	500	1.0	275	4.00	80 × 10 ³	3.5	10	2.5	125	0.0870	W93
S0500YC25Y	2500	100	500	1.0	275	4.00	80 × 10 ³	3.5	10	2.5	125	0.0870	W93
S0500KC200	2000	2000	500	1.0	330	4.00	80 × 10 ³	3.5	10	2.5	125	0.0650	W34
S0500KC20Y	2000	100	500	1.0	330	4.00	80 × 10 ³	3.5	10	2.5	125	0.0650	W34
S0500KC25D	2500	2000	500	1.0	330	4.00	80 × 10 ³	3.5	10	2.5	125	0.0650	W34
S0500KC25Y	2500	100	500	1.0	330	4.00	80 × 10 ³	3.5	10	2.5	125	0.0650	W34
S0700KC140	1400	1400	700	1.5	430	5.00	125 × 10 ³	3.0	10	2.2	125	0.0630	W34
S0700KC14Y	1400	100	700	1.5	430	5.00	125 × 10 ³	3.0	10	2.2	125	0.0630	W34
S0700KC17D	1700	1400	700	1.5	430	5.00	125 × 10 ³	3.0	10	2.2	125	0.0630	W34
S0700KC17Y	1700	100	700	1.5	430	5.00	125 × 10 ³	3.0	10	2.2	125	0.0630	W34
S1200NC200	2000	2000	1200	3.0	790	13.00	840 × 10 ³	4.5	19	2.7	125	0.0270	W36
S1200NC20Y	2000	100	1200	3.0	790	13.00	840 × 10 ³	4.5	19	2.7	125	0.0270	W36
S1200NC25D	2500	2000	1200	3.0	790	13.00	840 × 10 ³	4.5	19	2.7	125	0.0270	W36
S1200NC25Y	2500	100	1200	3.0	790	13.00	840 × 10 ³	4.5	19	2.7	125	0.0270	W36

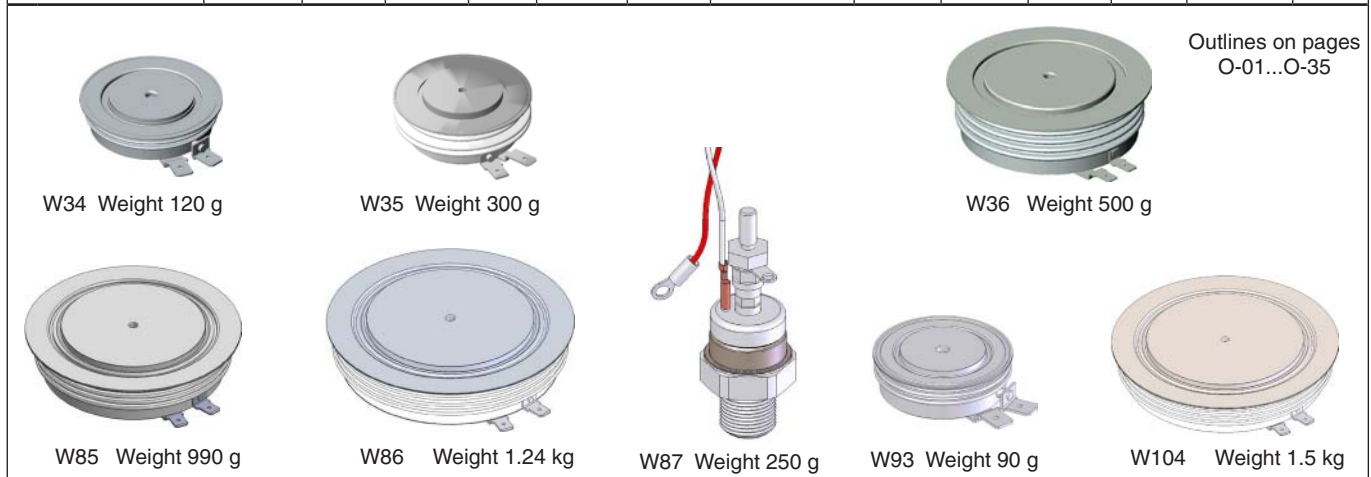

Insulated Gate Bi-polar Transistors

Capsule Types

As a pioneer of Press-Pack IGBT technology, we are able to offer a range of class leading devices with voltage ratings of 1.7kV (900V DC link), 2.5kV (1.25kV DC link), 4.5kV (2.8kV DC link) and 6.5kV (3.6kV DC link). The construction of these devices is totally free from wire and solder bonds which all but eliminates the problems of mechanical fatigue associated with conventional modules. Internal stray inductance in both the gate connections and emitter connections is vastly reduced when compared to conventional modules leading to improved ruggedness and short circuit behavior, which is further enhanced by direct cooling of the emitter side of the chip.

These devices are based on a state of the art soft punch through (SPT++) process, which yields exceptional values of $V_{CE(sat)}$ and soft switching behavior despite the high voltage ratings. The devices feature a positive temperature coefficient making them suitable for reliable parallel operation. Devices are available with or without integral anti-parallel diode; a range of complimentary High Power Sonic Diodes optimized for use with these IGBTs are available now with a new generation using improved technology in development. Please contact your representative for more information.

The press-pack IGBTs exhibit exceptional power cycling performance; typically an order of magnitude better than modules, making them highly suited to applications such as metals and traction drive systems where there are repeated cyclic power demands. Press-pack IGBTs have a stable short circuit failure mode which, as well as safety benefits, makes them an ideal choice for medium and high voltage applications where series connection is required. Stable short circuit failure mode allows for the design in of n+ redundancy without additional bypass switches and costly explosion proof enclosures. Typical examples include HVDC, FACTS, Active VAR controllers / compensators and medium voltage drives. In applications above 4MW press-pack IGBTs offer exceptional power density, far exceeding that achievable with comparable modules in multi-level / MMC based converters.

These PPIGBT's are largely backwardly compatible with standard 2.5kV and 4.5kV GTOs in many applications such as AC drives. This makes these parts a simple and economical path to upgrade or refurbish equipment that previously used GTOs, such as locomotives or medium voltage drives. They are suitable for all cooling options including direct liquid immersion. Complementary gate drives, mounting clamps and passive components available.

Part No.	V_{CES}	I_C	I_{CM}	$V_{CE(sat)}$ @ I_C	IGBT Switching		V_F $I_F = I_C$	Diode Recovery			T_{JM}	R_{thJK}		Fig. No.
					Typical E_{ON}	Typical E_{OFF}		Typical I_{rm}	Typical t_{rr}	Typical Q_r		IGBT	Diode	
➤ New	V	A	A	V	J	J	V	A	μs	μC	°C	K/W	K/W	
➤ T0600NC17A	1700	600	1200	3.0	0.29	0.50	2.25	300	0.5	175	125	0.0541	0.125	W40
➤ T0840NC17E	1700	840	1680	3.0	0.41	0.70	N/A	N/A	N/A	N/A	125	0.0386	N/A	W40
T0960VC17G	1700	960	1920	3.0	0.47	0.80	2.05	540	0.6	310	125	0.0338	0.0625	W67
➤ T1440VC17E	1700	1440	2880	3.0	0.70	1.20	N/A	N/A	N/A	N/A	125	0.0225	N/A	W67
➤ T1680TC17G	1700	1680	3360	3.0	0.82	1.40	2.05	945	0.5	545	125	0.0193	0.0357	W41
➤ T0140QC33G	3300	140	280	3.35	0.37	0.38	3.0	100	1.9	150	125	0.108	0.1728	W109
➤ T0285NC33E	3300	285	570	3.4	0.73	0.75	N/A	N/A	N/A	N/A	125	0.0546	N/A	W40
➤ T0425VC33G	3300	425	850	3.4	1.1	1.12	3.0	305	1.7	440	125	0.0364	0.0576	W67
➤ T0640VC33E	3300	640	1280	3.4	1.65	1.68	N/A	N/A	N/A	N/A	125	0.0243	N/A	W67
➤ T0710TC33A	3300	710	1420	3.4	1.83	1.87	3.3	455	1.5	655	125	0.0218	0.0432	W41
➤ T1000TC33E	3300	1000	2000	3.4	2.6	2.7	N/A	N/A	N/A	N/A	125	0.0156	N/A	W41
➤ T1000EC33G	3300	1000	2000	3.4	2.6	2.7	3.0	470	1.7	1040	125	0.0156	0.0247	W44
➤ T1500EC33E	3300	1500	3000	3.4	3.9	4.05	N/A	N/A	N/A	N/A	125	0.0104	N/A	W44
➤ T2000GC33G	3300	2000	4000	3.4	5.2	5.4	3.0	940	2.2	2070	125	0.0078	0.0123	W45

Outlines on pages O-01...O-35

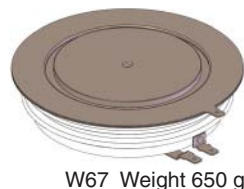
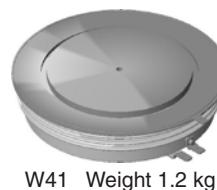

Insulated Gate Bi-polar Transistors

Capsule Types

Part No. ⊕ under development ➤ New	V_{CES} V	I_C A	I_{CM} A	$V_{CE(sat)}$ @ I_C V	IGBT Switching		V_F $I_F = I_C$ V	Diode Recovery			T_{JM} °C	R_{thJK}		Fig. No.
					Typical			I_{rm} A	t_{rr} μs	Q_r μC		IGBT	Diode	
					E_{ON} J	E_{OFF} J								
➤ T0115QC45G	4500	115	230	3.5	0.83	0.48	3.45	95	2.5	180	125	0.1080	0.1728	W109
T0240NB45E	4500	240	480	3.6	1.5	1.0	N/A	N/A	N/A	N/A	125	0.0546	N/A	W40
T0340VB45G	4500	340	680	3.5	2.2	1.3	3.45	220	3.2	500	125	0.0364	0.0576	W67
T0510VB45E	4500	510	1020	3.5	3.3	2.2	N/A	N/A	N/A	N/A	125	0.0243	N/A	W67
T0600TB45A	4500	600	1200	3.7	3.6	2.5	3.7	640	1.2	700	125	0.0218	0.0432	W41
T0800TB45E	4500	800	1600	3.5	5	3.5	N/A	N/A	N/A	N/A	125	0.0156	N/A	W41
T0800EB45G	4500	800	1600	3.5	5	3.5	3.5	550	1.7	1020	125	0.0156	0.0247	W44
T0900EB45A	4500	900	1800	3.6	5.4	3.8	3.9	800	1.6	1000	125	0.0146	0.0288	W44
T1200EB45E	4500	1200	2400	3.6	7	5.5	N/A	N/A	N/A	N/A	125	0.0104	N/A	W44
T1600GB45G	4500	1600	3200	3.5	12	8.7	3.45	1270	1.75	1960	125	0.0078	0.0123	W45
T1800GB45A	4500	1800	3600	3.6	11	10.5	3.9	1600	1.6	2000	125	0.0073	0.0115	W45
➤ T2000BB45G	4500	2000	4000	3.5	14	12.5	3.55	2050	1.6	2450	125	0.0064	0.0096	W110
T2400GB45E	4500	2400	4800	3.6	14	13	N/A	N/A	N/A	N/A	125	0.0052	N/A	W45
T2960BB45E	4500	3000	6000	3.6	11.5	17.5	N/A	N/A	N/A	N/A	125	0.0042	N/A	W110
T0258HF65G	6500	258	516	4.8	1.8	1.45	3.45	300	1.2	410	125	0.0328	0.0567	W95
T0385HF65E	6500	385	770	4.8	2.7	2.2	N/A	N/A	N/A	N/A	125	0.0219	N/A	W95
T0600AF65G	6500	600	1030	4.8	4.2	3.4	3.5	700	1.2	950	125	0.0141	0.0243	W98
T0900AF65E	6500	900	1800	4.8	6.3	5.1	N/A	N/A	N/A	N/A	125	0.0094	N/A	W98
T0900DF65A	6500	900	1800	4.8	6.3	5.1	3.4	1050	1.2	1450	125	0.0094	0.0155	W96
T1290BF65A	6500	1290	2580	4.8	9.0	7.3	3.6	1400	1.1	1900	125	0.0066	0.0122	W103
T1375DF65E	6500	1375	2750	4.8	9.6	7.8	N/A	N/A	N/A	N/A	125	0.0062	N/A	W96
T1890BF65E	6500	1890	3780	4.8	13.2	10.6	N/A	N/A	N/A	N/A	125	0.0045	N/A	W103

Outlines on pages O-01...O-35



W40 Weight 430 g

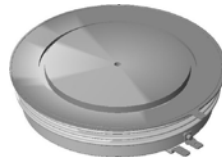

W41 Weight 1.2 kg



W44 Weight 1.2 kg



W45 Weight 2 kg

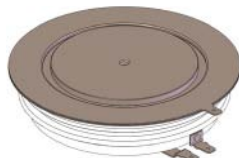

W67 Weight 650 g



W95 Weight 825 g

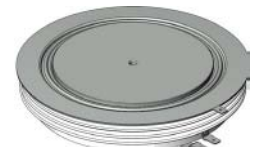

W96 Weight 1.5 kg



W98 Weight 1.8 kg

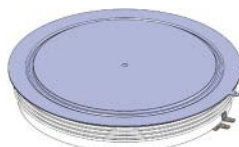

W103 Weight 3.2 kg



W109 Weight 360 g

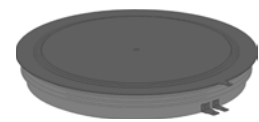

W110 Weight 2.8 kg

Insulated Gate Bi-polar Transistors

Module Types

Part No.	V_{CES}	I_C	I_{CM}	$V_{CE(sat)}$ @ I_C	IGBT Switching		V_F $I_F = I_C$	Diode Recovery				T_{JM}	R_{thJK}		Fig. No.
					Typical E_{ON} J	Typical E_{OFF} J		Typical I_{rm} A	Typical t_{rr} μs	Typical Q_r μC	Typical E_{rec} J		IGBT K/W	Diode K/W	
➤ New	V	A	A	V	J	J	V	A	μs	μC	J	$^{\circ}C$	K/W	K/W	
➤ MTE1200AD45AA	4500	1200	2400	3.40	7.70	7.00	3.30	1700	0.60	710	2.30	125	0.0075	0.0133	W125

W125 Weight 1.35 kg



Press-Pack IGBT Gate Drive Units

The C044BG400 IGBT Gate Driver is a low power consumption driver with on board VCE desaturation detection for high reliability application. The driver features a fibre-optic communication interface for drive, status and switching feedback signals. A fully supervised DC/DC converter with EMI filtering, low coupling capacitance and high partial discharge level is integrated into the board. The high voltage collector sense and gate interface are implemented on a separate card to allow close coupling to the IGBT. A range of pre-configured boards is available to complement IXYS UK's range of press-pack IGBTs – other applications on request.

Gate Drive Part Number	IGBT Type
C0044BG400SCB	T0600NC17A
C0044BG400SCA	T0840NC17E
C0044BG400SCC	T0960VC17G
C0044BG400SCD	T1440VC17E
C0044BG400SCE	T1680TC17G
C0044BG400SCF	T0140QC33G
C0044BG400SCG	T0285NC33E
C0044BG400SCH	T0425VC33G
C0044BG400SCJ	T0640VC33E
C0044BG400SCK	T0710TC33A
C0044BG400SCM	T1000EC33G
C0044BG400SCL	T1000TC33E
C0044BG400SCN	T1500EC33E
C0044BG400SCS	T2000GC33G
C0044BG400SCR	T0115QC45G
C0044BG400SBL	T0240NB45E
C0044BG400SBQ	T0340VB45G
C0044BG400SBE	T0510VB45E
C0044BG400SBM	T0600TB45A
C0044BG400SBG	T0800EB45G
C0044BG400SBN	T0800TB45E
C0044BG400SBP	T0900EB45A
C0044BG400SBR	T1200EB45E
C0044BG400SBJ	T1600GB45G
C0044BG400SBS	T1800GB45A
C0044BG400SBZ	T2000BB45G
C0044BG400SBT	T2400GB45E
C0044BG400SBW	T2960BB45E



FEATURES

- High reliability topology
- Designed for ultra low power consumption
- Built in DC/DC-converter with soft start
- Integrated input filter for low EMI
- Separate low impedance path for parasitic EMI currents
- PD-Voltage levels available up to 11 kV on request.
- Low impedance from gate to emitter at start-up and power fail
- Monitoring of all secondary supply voltages
- Monitoring of IGBT switching status (VCE-de-sat detection)
- Soft switch-OFF at $V_{CE-de-sat}$ fault condition
- Fiber-optic links for switching commands and status control
- Low light protection for input signal
- Short-pulse suppression. configurable
- Balanced propagation delay time
- Gate Current up to 44 A
- Optional gate-speed-up capacitors

APPLICATION

- Large and medium drives
- Renewable generation.
- Utilities scale converters

Dual Thyristor Modules

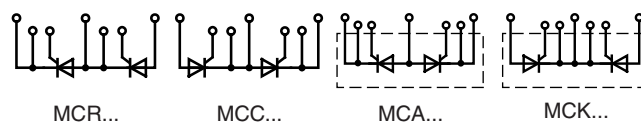

IXYS UK Westcode Ltd. has UL Certification for most modules (Underwriters Laboratories Inc). See the UL Listing.

Part No.	V_{RRM}	I_{TAV}	@ T_c	I_{TRMS}	I_{TSM}	V_{TO}	r_T	T_{VJM}	per Die		Fig. No.
	V_{DRM}								R_{thJC}	R_{thCH}	
	V	A	°C	A	A	V	mΩ	°C	K/W	K/W	
MCC160-30io3	3000	170	85	385	3650	1.200	2.300	125	0.110	0.0400	W102
MCC160-36io3	3600	170	85	385	3650	1.200	2.300	125	0.110	0.0400	W102
MCC220-28io3	2800	235	85	543	5000	0.900	1.100	125	0.110	0.0400	W102
MCC265-24io3	2400	280	85	655	6900	0.800	0.700	125	0.110	0.0400	W102
MCC320-30io2	3000	327	85	765	5000	1.150	0.800	125	0.062	0.0200	W74
MCC320-36io2	3600	327	85	765	5000	1.150	0.800	125	0.062	0.0200	W74
MCC325-14io3	1400	345	85	785	7650	0.750	0.500	125	0.110	0.0400	W102
MCC325-18io3	1800	345	85	785	7650	0.750	0.500	125	0.110	0.0400	W102
MCC380-28io2	2800	395	85	620	8100	1.000	0.650	125	0.062	0.0200	W74
MCC431-20io2	2000	429	85	1020	10900	1.000	0.410	125	0.062	0.0200	W74
MCC431-22io2	2200	429	85	1020	10900	1.000	0.410	125	0.062	0.0200	W74
MCC431-24io2	2400	429	85	1020	10900	1.000	0.410	125	0.062	0.0200	W74
MCC500-14io1	1400	500	89	1294	16500	0.850	0.270	125	0.062	0.0200	W63
MCC500-18io1	1800	500	89	1294	16500	0.850	0.270	125	0.062	0.0200	W63
MCC500-22io1	2200	500	80	1071	14000	0.880	0.460	125	0.062	0.0200	W63
MCK500-14io1	1400	500	89	1294	16500	0.850	0.270	125	0.062	0.0200	W63
MCK500-18io1	1800	500	89	1294	16500	0.850	0.270	125	0.062	0.0200	W63
MCK500-22io1	2200	500	80	1071	14000	0.880	0.460	125	0.062	0.0200	W63
MCA500-14io1	1400	500	89	1294	16500	0.850	0.270	125	0.062	0.0200	W63
MCA500-18io1	1800	500	89	1294	16500	0.850	0.270	125	0.062	0.0200	W63
MCA500-22io1	2200	500	80	1071	14000	0.880	0.460	125	0.062	0.0200	W63
MCC501-12io2	1200	503	85	1195	14500	0.850	0.300	125	0.062	0.0200	W74
MCC501-14io2	1400	503	85	1195	14500	0.850	0.300	125	0.062	0.0200	W74
MCC501-16io2	1600	503	85	1195	14500	0.850	0.300	125	0.062	0.0200	W74
MCC501-18io2	1800	503	85	1195	14500	0.850	0.300	125	0.062	0.0200	W74
MCC550-12io1	1200	550	85	1318	18000	0.839	0.244	125	0.062	0.0200	W63
MCC550-16io1	1600	550	85	1318	18000	0.839	0.244	125	0.062	0.0200	W63
MCK550-12io1	1200	550	85	1318	18000	0.839	0.244	125	0.062	0.0200	W63
MCK550-16io1	1600	550	85	1318	18000	0.839	0.244	125	0.062	0.0200	W63
MCA550-12io1	1200	550	85	1318	18000	0.839	0.244	125	0.062	0.0200	W63
MCA550-16io1	1600	550	85	1318	18000	0.839	0.244	125	0.062	0.0200	W63
MCC552-12io2	1200	550	85	1300	15800	0.770	0.259	125	0.062	0.0200	W74
MCC552-14io2	1400	550	85	1300	15800	0.770	0.259	125	0.062	0.0200	W74
MCC552-16io2	1600	550	85	1300	15800	0.770	0.259	125	0.062	0.0200	W74
MCC500-30io7	3000	500	85	1181	16200	1.079	0.422	125	0.050	0.0160	W88
MCC500-36io7	3600	500	85	1181	16200	1.079	0.422	125	0.050	0.0160	W88
MCR500-30io7	3000	500	85	1181	16200	1.079	0.422	125	0.050	0.0160	W88
MCR500-36io7	3600	500	85	1181	16200	1.079	0.422	125	0.050	0.0160	W88
MCC580-28io7	2800	581	85	1372	18900	0.926	0.313	125	0.050	0.0160	W88
MCR580-28io7	2800	581	85	1372	18900	0.926	0.313	125	0.050	0.0160	W88
MCC650-24io7	2400	646	85	1542	22100	0.874	0.227	125	0.050	0.0160	W88
MCR650-24io7	2400	646	85	1542	22100	0.874	0.227	125	0.050	0.0160	W88
MCC720-14io7	1400	719	85	1633	25200	0.823	0.241	130	0.050	0.0160	W88
MCC720-18io7	1800	719	85	1633	25200	0.823	0.241	130	0.050	0.0160	W88
MCR720-14io7	1400	719	85	1633	25200	0.823	0.241	130	0.050	0.0160	W88
MCR720-18io7	1800	719	85	1633	25200	0.823	0.241	130	0.050	0.0160	W88

Single Thyristor Modules

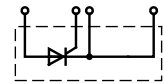

MCO

Part No.	V_{RRM}	I_{TAV}	@ T_C	I_{TRMS}	I_{TSM} 125°C 10ms	V_{T0}	r_T	T_{VJM}	per Die		Fig. No.
	V_{DRM}								R_{thJC}	R_{thCH}	
➤ New	V	A	°C	A	A	V	mΩ	°C	K/W	K/W	
MCO560-30io1	3000	560	85	879	18900	1.050	0.470	125	0.042	0.0100	W73
MCO560-36io1	3600	560	85	879	18900	1.050	0.470	125	0.042	0.0100	W73
MCO635-28io1	2800	635	85	1880	20700	0.950	0.350	125	0.042	0.0100	W73
MCO741-22io1	2200	765	85	2110	29000	0.850	0.277	125	0.042	0.0100	W73
MCO801-14io1	1400	830	85	2335	30000	0.800	0.240	130	0.042	0.0100	W73
MCO801-18io1	1800	830	85	2335	30000	0.800	0.240	130	0.042	0.0100	W73
➤ N4340TJ180MBR	1800	1110	85	3500	55000	0.886	0.105	125	0.031	0.0035	W116
➤ N4340TJ220MBR	2200	1110	85	3500	55000	0.886	0.105	125	0.031	0.0035	W116

Outlines on pages O-01...O-35

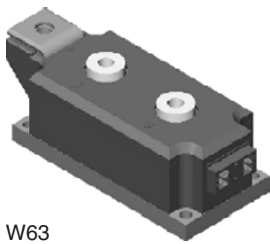

W63

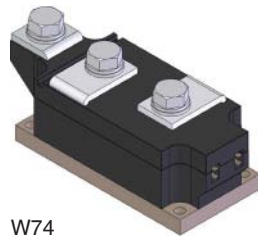

W74

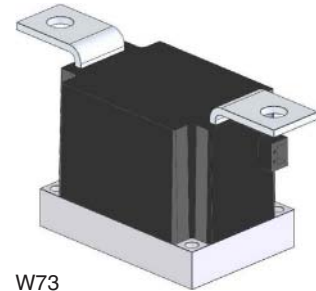

W73

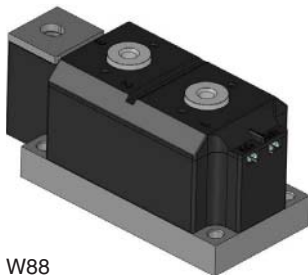

W88

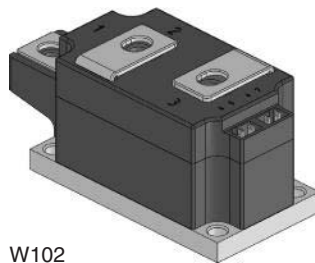

W102

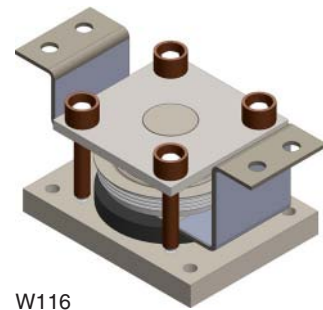

W116

Thyristor / Diode Modules

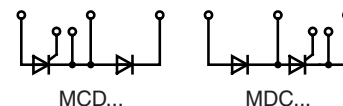

IXYS UK Westcode Ltd. has UL Certification for most modules (Underwriters Laboratories Inc). See the UL Listing.

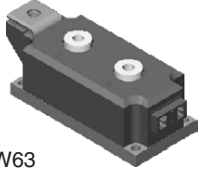
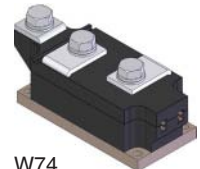
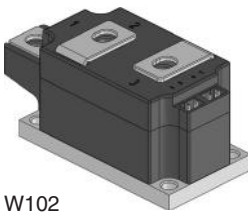
Part No.	V_{RRM}	I_{TAV}	@ T_C	I_{TRMS}	I_{TSM} 125°C 10 ms	V_{TO}	r_T	T_{VJM}	per Die		Fig. No.	Package style Outline drawings on page O-01...O-35
	V_{DRM}								R_{thJC}	R_{thCH}		
	V	A	°C	A	A	V	mΩ	°C	K/W	K/W		
MCD160-30io3	3000	170	85	385	3650	1.200	2.300	125	0.110	0.0400	W102	 W63
MCD160-36io3	3600	170	85	385	3650	1.200	2.300	125	0.110	0.0400	W102	
MDC160-30io3	3000	170	85	385	3650	1.200	2.300	125	0.110	0.0400	W102	
MDC160-36io3	3600	170	85	385	3650	1.200	2.300	125	0.110	0.0400	W102	
MCD220-28io3	2800	235	85	543	5000	0.900	1.100	125	0.110	0.0400	W102	
MDC220-28io3	2800	235	85	543	5000	0.900	1.100	125	0.110	0.0400	W102	
MCD265-24io3	2400	280	85	655	6900	0.800	0.700	125	0.110	0.0400	W102	
MDC265-24io3	2400	280	85	655	6900	0.800	0.700	125	0.110	0.0400	W102	
MCD320-30io2	3000	327	85	765	5000	1.150	0.800	125	0.065	0.0200	W74	
MCD320-36io2	3600	327	85	765	5000	1.150	0.800	125	0.065	0.0200	W74	
MDC320-30io2	3000	327	85	765	5000	1.150	0.800	125	0.065	0.0200	W74	
MDC320-36io2	3600	327	85	765	5000	1.150	0.800	125	0.065	0.0200	W74	
MCD325-14io3	1400	345	85	785	7650	0.750	0.500	125	0.110	0.0400	W102	 W74
MCD325-18io3	1800	345	85	785	7650	0.750	0.500	125	0.110	0.0400	W102	
MDC325-14io3	1400	345	85	785	7650	0.750	0.500	125	0.110	0.0400	W102	
MDC325-18io3	1800	345	85	785	7650	0.750	0.500	125	0.110	0.0400	W102	
MCD380-28io2	2800	395	85	620	8100	1.000	0.650	125	0.062	0.0200	W74	
MDC380-28io2	2800	395	85	620	8100	1.000	0.650	125	0.062	0.0200	W74	
MCD431-20io2	2000	429	85	1020	10900	1.000	0.410	125	0.062	0.0200	W74	
MCD431-22io2	2200	429	85	1020	10900	1.000	0.410	125	0.062	0.0200	W74	
MCD431-24io2	2400	429	85	1020	10900	1.000	0.410	125	0.062	0.0200	W74	
MDC431-20io2	2000	429	85	1020	10900	1.000	0.410	125	0.062	0.0200	W74	
MDC431-22io2	2200	429	85	1020	10900	1.000	0.410	125	0.062	0.0200	W74	
MDC431-24io2	2400	429	85	1020	10900	1.000	0.410	125	0.062	0.0200	W74	
MCD500-14io1	1400	500	89	1294	16500	0.820	0.270	125	0.062	0.0200	W63	 W102
MCD500-18io1	1800	500	89	1294	16500	0.820	0.270	125	0.062	0.0200	W63	
MCD500-22io1	2200	500	80	1071	14000	0.880	0.460	125	0.062	0.0200	W63	
MDC500-14io1	1400	500	89	1294	16500	0.820	0.270	125	0.062	0.0200	W63	
MDC500-18io1	1800	500	89	1294	16500	0.820	0.270	125	0.062	0.0200	W63	
MDC500-22io1	2200	500	80	1071	14000	0.880	0.460	125	0.062	0.0200	W63	
MCD501-12io2	1200	503	85	1195	14500	0.850	0.300	125	0.062	0.0200	W74	
MCD501-14io2	1400	503	85	1195	14500	0.850	0.300	125	0.062	0.0200	W74	
MCD501-16io2	1600	503	85	1195	14500	0.850	0.300	125	0.062	0.0200	W74	
MCD501-18io2	1800	503	85	1195	14500	0.850	0.300	125	0.062	0.0200	W74	
MDC501-12io2	1200	503	85	1195	14500	0.850	0.300	125	0.062	0.0200	W74	
MDC501-14io2	1400	503	85	1195	14500	0.850	0.300	125	0.062	0.0200	W74	
MDC501-16io2	1600	503	85	1195	14500	0.850	0.300	125	0.062	0.0200	W74	
MDC501-18io2	1800	503	85	1195	14500	0.850	0.300	125	0.062	0.0200	W74	
MCD550-12io1	1200	550	85	1318	18000	0.839	0.244	125	0.062	0.0200	W63	
MCD550-16io1	1600	550	85	1318	18000	0.839	0.244	125	0.062	0.0200	W63	

Thyristor / Diode Modules

IXYS UK Westcode Ltd. has UL Certification for most modules (Underwriters Laboratories Inc). See the UL Listing.

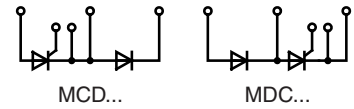

Part No.	V_{RRM}	I_{TAV}	$@ T_C$	I_{TRMS}	I_{TSM}	V_{TO}	r_T	T_{VJM}	R_{thJC}	R_{thCH}	Fig. No.	Package style Outline drawings on page O-01...O-35
	V_{DRM}		$^{\circ}C$		125 $^{\circ}C$ 10 ms		$m\Omega$	$^{\circ}C$	per Die			
	V	A		A	A	V			K/W	K/W		
MDC550-12io1	1200	550	85	1318	18000	0.839	0.244	125	0.062	0.0200	W63	
MDC550-16io1	1600	550	85	1318	18000	0.839	0.244	125	0.062	0.0200	W63	
MCD552-12io2	1200	550	85	1300	15800	0.770	0.259	125	0.062	0.0200	W74	
MCD552-14io2	1400	550	85	1300	15800	0.770	0.259	125	0.062	0.0200	W74	
MCD552-16io2	1600	550	85	1300	15800	0.770	0.259	125	0.062	0.0200	W74	
MDC552-12io2	1200	550	85	1300	15800	0.770	0.259	125	0.062	0.0200	W74	
MDC552-14io2	1400	550	85	1300	15800	0.770	0.259	125	0.062	0.0200	W74	
MDC552-16io2	1600	550	85	1300	15800	0.770	0.259	125	0.062	0.0200	W74	
MCD500-30io7	3000	500	85	1181	16200	1.079	0.422	125	0.050	0.0160	W88	
MCD500-36io7	3600	500	85	1181	16200	1.079	0.422	125	0.050	0.0160	W88	
MDC500-30io7	3000	500	85	1181	16200	1.079	0.422	125	0.050	0.0160	W88	
MDC500-36io7	3600	500	85	1181	16200	1.079	0.422	125	0.050	0.0160	W88	
MCD580-28io7	2800	581	85	1372	18900	0.926	0.313	125	0.050	0.0160	W88	
MDC580-28io7	2800	581	85	1372	18900	0.926	0.313	125	0.050	0.0160	W88	
MCD650-24io7	2400	646	85	1542	22100	0.874	0.227	125	0.050	0.0160	W88	
MDC650-24io7	2400	646	85	1542	22100	0.874	0.227	125	0.050	0.0160	W88	
MCD720-14io7	1400	719	85	1633	25200	0.823	0.241	125	0.050	0.0160	W88	
MCD720-18io7	1800	719	85	1633	25200	0.823	0.241	125	0.050	0.0160	W88	
MDC720-14io7	1400	719	85	1633	25200	0.823	0.241	125	0.050	0.0160	W88	
MDC720-18io7	1800	719	85	1633	25200	0.823	0.241	125	0.050	0.0160	W88	

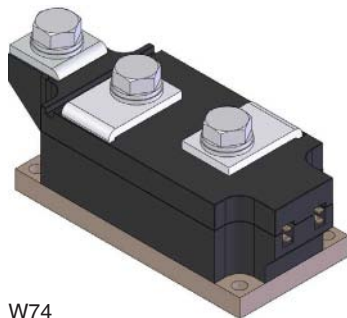

W74

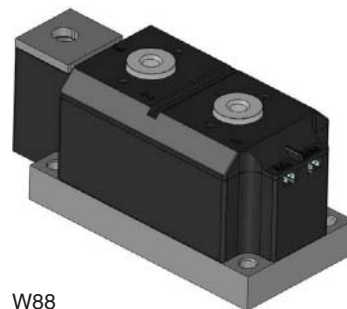

W88

Dual Diode Modules

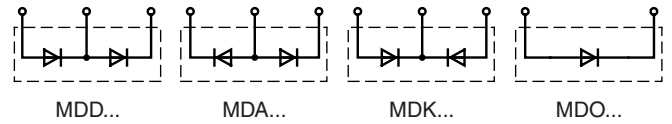

IXYS UK Westcode Ltd. has UL Certification for most modules (Underwriters Laboratories Inc). See the UL Listing.

Part No.	V_{RRM}	I_{FAV}	$@ T_C$	I_{FRMS}	I_{FSM}	V_{TO}	r_T	T_{VJM}	R_{thJC}	R_{thCK}	Fig. No.
	V	A	°C	A	150°C 10 ms A	V	mΩ	°C	per Die K/W K/W		
MDD275-30N3	3000	290	85	580	4500	0.90	1.570	150	0.110	0.0400	W102
MDD275-36N3	3600	290	85	580	4500	0.90	1.570	150	0.110	0.0400	W102
MDA275-30N3	3000	290	85	580	4500	0.90	1.570	150	0.110	0.0400	W102
MDA275-36N3	3600	290	85	580	4500	0.90	1.570	150	0.110	0.0400	W102
MDK275-30N3	3000	290	85	580	4500	0.90	1.570	150	0.110	0.0400	W102
MDK275-36N3	3600	290	85	580	4500	0.90	1.570	150	0.110	0.0400	W102
MDD410-24N3	2400	440	85	910	7800	0.85	0.450	150	0.110	0.0400	W102
MDD410-28N3	2800	440	85	910	7800	0.85	0.450	150	0.110	0.0400	W102
MDA410-24N3	2400	440	85	910	7800	0.85	0.450	150	0.110	0.0400	W102
MDA410-28N3	2800	440	85	910	7800	0.85	0.450	150	0.110	0.0400	W102
MDK410-24N3	2400	440	85	910	7800	0.85	0.450	150	0.110	0.0400	W102
MDK410-28N3	2800	440	85	910	7800	0.85	0.450	150	0.110	0.0400	W102
MDD510-14N3	1400	545	85	1135	10900	0.75	0.250	150	0.110	0.0400	W102
MDD510-18N3	1800	545	85	1135	10900	0.75	0.250	150	0.110	0.0400	W102
MDA510-14N3	1400	545	85	1135	10900	0.75	0.250	150	0.110	0.0400	W102
MDA510-18N3	1800	545	85	1135	10900	0.75	0.250	150	0.110	0.0400	W102
MDK510-14N3	1400	545	85	1135	10900	0.75	0.250	150	0.110	0.0400	W102
MDK510-18N3	1800	545	85	1135	10900	0.75	0.250	150	0.110	0.0400	W102
MDD600-14N1	1400	600	111	1818	21800	0.75	0.200	150	0.062	0.0200	W63
MDD600-18N1	1800	600	111	1818	21800	0.75	0.200	150	0.062	0.0200	W63
MDD600-22N1	2200	600	111	1818	21800	0.75	0.200	150	0.062	0.0200	W63
MDA600-14N1	1400	600	111	1818	21800	0.75	0.200	150	0.062	0.0200	W63
MDA600-18N1	1800	600	111	1818	21800	0.75	0.200	150	0.062	0.0200	W63
MDA600-22N1	2200	600	111	1818	21800	0.75	0.200	150	0.062	0.0200	W63
MDK600-14N1	1400	600	111	1818	21800	0.75	0.200	150	0.062	0.0200	W63
MDK600-18N1	1800	600	111	1818	21800	0.75	0.200	150	0.062	0.0200	W63
MDK600-22N1	2200	600	111	1818	21800	0.75	0.200	150	0.062	0.0200	W63
MDD630-30N2	3000	630	85	1275	11700	0.80	0.500	150	0.062	0.0200	W74
MDD630-36N2	3600	630	85	1275	11700	0.80	0.500	150	0.062	0.0200	W74
MDA630-30N2	3000	630	85	1275	11700	0.80	0.500	150	0.062	0.0200	W74
MDA630-36N2	3600	630	85	1275	11700	0.80	0.500	150	0.062	0.0200	W74
MDK630-30N2	3000	630	85	1275	11700	0.80	0.500	150	0.062	0.0200	W74
MDK630-36N2	3600	630	85	1275	11700	0.80	0.500	150	0.062	0.0200	W74
MDD 710-22N2	2200	708	85	1440	12750	0.80	0.350	150	0.062	0.0200	W74
MDD 710-26N2	2600	708	85	1440	12750	0.80	0.350	150	0.062	0.0200	W74
MDA 710-22N2	2200	708	85	1440	12750	0.80	0.350	150	0.062	0.0200	W74
MDA 710-26N2	2600	708	85	1440	12750	0.80	0.350	150	0.062	0.0200	W74
MDK 710-22N2	2200	708	85	1440	12750	0.80	0.350	150	0.062	0.0200	W74
MDK 710-26N2	2600	708	85	1440	12750	0.80	0.350	150	0.062	0.0200	W74
MDD 810-12N2	1200	807	85	1661	17250	0.78	0.230	150	0.062	0.0200	W74
MDD 810-16N2	1600	807	85	1661	17250	0.78	0.230	150	0.062	0.0200	W74
MDD 810-18N2	1800	807	85	1661	17250	0.78	0.230	150	0.062	0.0200	W74
MDA 810-12N2	1200	807	85	1661	17250	0.78	0.230	150	0.062	0.0200	W74
MDA 810-16N2	1600	807	85	1661	17250	0.78	0.230	150	0.062	0.0200	W74
MDA 810-18N2	1800	807	85	1661	17250	0.78	0.230	150	0.062	0.0200	W74

Dual Diode Modules

IXYS UK Westcode Ltd. has UL Certification for most modules (Underwriters Laboratories Inc). See the UL Listing.

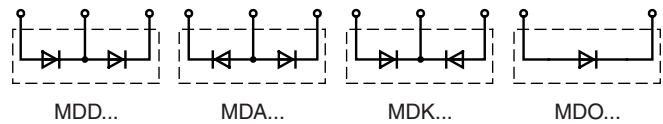

Part No.	V_{RRM}	I_{FAV}	$@ T_C$	I_{FRMS}	I_{FSM}	V_{T0}	r_T	T_{VJM}	R_{thJC} R_{thCK}		Fig. No.
	V	A	°C	A	150°C 10 ms A	V	mΩ	°C	per Die K/W K/W		
MDK 810-12N2	1200	807	85	1661	17250	0.78	0.230	150	0.062	0.0200	W74
MDK 810-16N2	1600	807	85	1661	17250	0.78	0.230	150	0.062	0.0200	W74
MDK 810-18N2	1800	807	85	1661	17250	0.78	0.230	150	0.062	0.0200	W74
MDD1080-18N7	1800	1080	85	2235	29100	0.78	0.157	150	0.050	0.0160	W88
MDD1080-24N7	2400	1080	85	2235	29100	0.78	0.157	150	0.050	0.0160	W88
MDD1080-28N7	2800	1080	85	2235	29100	0.78	0.157	150	0.050	0.0160	W88
MDA1080-18N7	1800	1080	85	2235	29100	0.78	0.157	150	0.050	0.0160	W88
MDA1080-24N7	2400	1080	85	2235	29100	0.78	0.157	150	0.050	0.0160	W88
MDA1080-28N7	2800	1080	85	2235	29100	0.78	0.157	150	0.050	0.0160	W88
MDK1080-18N7	1800	1080	85	2235	29100	0.78	0.157	150	0.050	0.0160	W88
MDK1080-24N7	2400	1080	85	2235	29100	0.78	0.157	150	0.050	0.0160	W88
MDK1080-28N7	2800	1080	85	2235	29100	0.78	0.157	150	0.050	0.0160	W88

Outlines on pages O-01...O-35

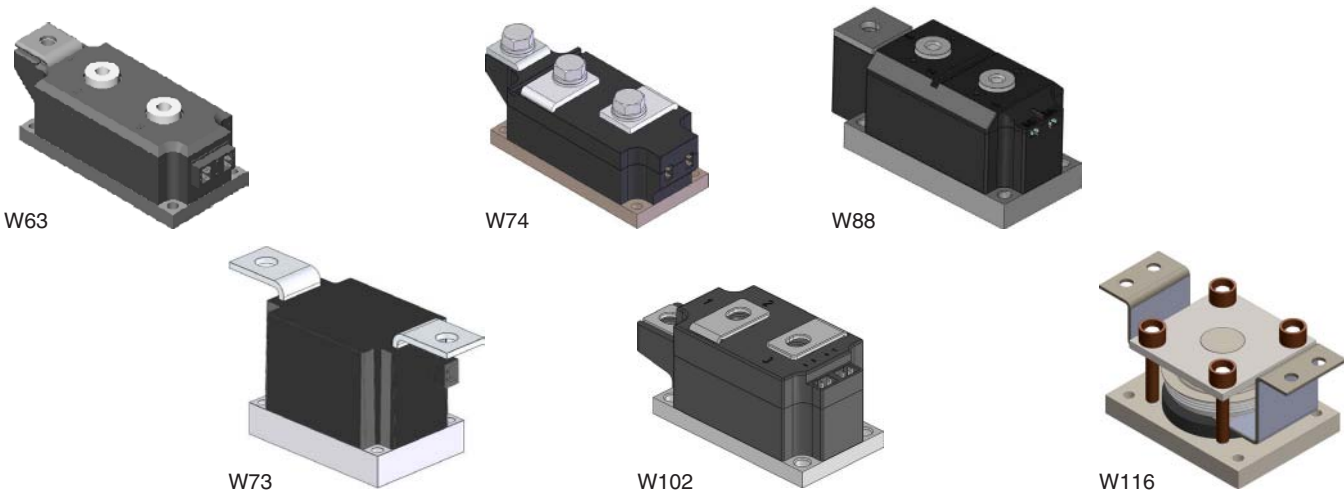

Single Diode Modules

IXYS UK Westcode Ltd. has UL Certification for most modules (Underwriters Laboratories Inc).

Part No.	V_{RRM}	I_{FAV}	$@ T_C$	I_{FRMS}	I_{FSM}	V_{T0}	r_T	T_{VJM}	R_{thJC} R_{thCK}		Fig. No.
	V	A	°C	A	150°C 10 ms A	V	mΩ	°C	per Die K/W K/W		
➤ New *											
MDO1120-24N1	2400	1189	85	1869	32400	0.80	0.170	150	0.042	0.0100	W73
MDO1120-28N1	2800	1189	85	1869	32400	0.80	0.170	150	0.042	0.0100	W73
MDO1201-14N1	1400	1520	85	3665	36000	0.80	0.100	160	0.042	0.0100	W73
MDO1201-18N1	1800	1520	85	3665	36000	0.80	0.100	160	0.042	0.0100	W73
MDO1201-22N1	2200	1520	85	3665	36000	0.80	0.100	160	0.042	0.0100	W73
➤ W8570TJ180MBR	1800	2830	85	6435	70200	0.69	0.050	175	0.031	0.0035	W116
➤ W8570TJ220MBR	2200	2830	85	6435	70200	0.69	0.050	175	0.031	0.0035	W116
➤ W9830TJ120MBR	1200	3345	85	7280	72000	0.67	0.043	190	0.031	0.0035	W116
➤ W9830TJ150MBR	1500	3345	85	7280	72000	0.67	0.043	190	0.031	0.0035	W116

Water Cooled Dual Diode Modules

IXYS UK's range of water cooled modules feature a direct cooled base, with no extra interface to the die allowing for more efficient cooling giving an enhanced average current rating.

IXYS UK Westcode Ltd has UL Certification for most modules (Underwriters Laboratories Inc).
See the UL Listing.

Part No.	V_{RRM}	I_{FAV}	@ T_C	I_{FRMS}	I_{FSM}	V_{TO}	r_T	T_{VJM}	R_{thJW}	Fig. No.	Package style Outline drawings on page O-01...O-35
	V	A	°C	A	A	V	mΩ	°C	per Die K/W		
MDD950-14N1W	1400	950	45	1773	21800	0.75	0.200	150	0.090	W64	
MDD950-18N1W	1800	950	45	1773	21800	0.75	0.200	150	0.090	W64	
MDD950-22N1W	2200	950	45	1773	21800	0.75	0.200	150	0.090	W64	
MDA950-14N1W	1400	950	45	1773	21800	0.75	0.200	150	0.090	W64	
MDA950-18N1W	1800	950	45	1773	21800	0.75	0.200	150	0.090	W64	
MDA950-22N1W	2200	950	45	1773	21800	0.75	0.200	150	0.090	W64	
MDK950-14N1W	1400	950	45	1773	21800	0.75	0.200	150	0.090	W64	
MDK950-18N1W	1800	950	45	1773	21800	0.75	0.200	150	0.090	W64	
MDK950-22N1W	2200	950	45	1773	21800	0.75	0.200	150	0.090	W64	



W64

Water Cooled Thyristor/Diode Modules

Part No.	V_{RRM}	I_{TAV}	@ T_C	I_{TRMS}	I_{TSM}	V_{TO}	r_T	T_{VJM}	R_{thJW}	Fig. No.
	V_{DRM}	A	°C	A	A	V	mΩ	°C	per Die K/W	
MCD600-22io1W	2200	600	40	1116	16500	0.88	0.460	125	0.090	W64
MDC600-22io1W	2200	600	40	1116	16500	0.88	0.460	125	0.090	W64
MCD700-14io1W	1400	700	42	1331	16500	0.85	0.270	125	0.090	W64
MCD700-18io1W	1800	700	42	1331	16500	0.85	0.270	125	0.090	W64
MDC700-14io1W	1400	700	42	1331	16500	0.85	0.270	125	0.090	W64
MDC700-18io1W	1800	700	42	1331	16500	0.85	0.270	125	0.090	W64

Water Cooled Dual Thyristor Modules

Part No.	V_{RRM}	I_{TAV}	@ T_C	I_{TRMS}	I_{TSM}	V_{TO}	r_T	T_{VJM}	R_{thJW}	Fig. No.
	V_{DRM}	A	°C	A	A	V	mΩ	°C	per Die K/W	
MCA600-22io1W	2200	600	40	1116	16500	0.88	0.460	125	0.090	W64
MCC600-22io1W	2200	600	40	1116	16500	0.88	0.460	125	0.090	W64
MCK600-22io1W	2200	600	40	1116	16500	0.88	0.460	125	0.090	W64
MCC700-14io1W	1400	700	42	1331	16500	0.85	0.270	125	0.090	W64
MCC700-18io1W	1800	700	42	1331	16500	0.85	0.270	125	0.090	W64
MCA700-14io1W	1400	700	42	1331	16500	0.85	0.270	125	0.090	W64
MCA700-18io1W	1800	700	42	1331	16500	0.85	0.270	125	0.090	W64
MCK700-14io1W	1400	700	42	1331	16500	0.85	0.270	125	0.090	W64
MCK700-18io1W	1800	700	42	1331	16500	0.85	0.270	125	0.090	W64

Power Semiconductor Assemblies From IXYS UK

Power Semiconductor Assemblies

With over 80 years of experience, our dedicated team of talented design engineers can deliver a wide variety of industry leading solutions ranging from simple standard sub-assemblies to complicated multi-megawatt power systems.

IXYS UK's power electronics assemblies group has been an integral part of our core business since the early 1920's when we began production of the first commercially available solid state rectifiers.

Our dedicated team of highly experienced specialists are on hand to provide our customers with first class support on everything from a simple air-cooled rectifier to a highly integrated custom power converter.

Using the latest 3D modelling and simulation techniques, we can significantly reduce the cycle time from concept to fully developed design, minimising risk and identifying opportunity for optimisation early in the project.

With double digit growth in the preceding 5 years, in 2010 we moved into a new 300m² dedicated production facility complemented by a well-equipped power lab. These new facilities, supported by an expanded team of engineers and technicians form the foundations for continued investment and growth in this strategic area of our business.

Standard Assemblies

IXYS UK's standard assemblies also include the new press-pack IGBT 3-level inverters. 3 separate designs are available, a totally independent 3.3kV system, a 6.6kV system and a 10kV system. The 6.6kV and 10kV systems are based on the combination of 2 IGBT stacks and 1 diode stack. Each system benefits from direct water cooling to provide highly effective heat dissipation away from the devices and pre-loaded disc spring clamping to evenly distribute the applied force across the entire surface area of the device.

Also designed into each system is an integrated snubber circuit design and an isolated clamping rod system to limit the occurrence of eddy currents within the unit.

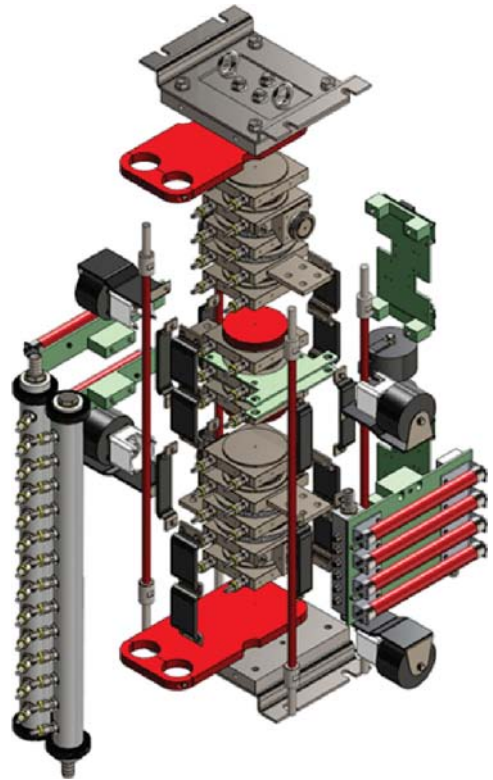

Pulsed Power

As a pioneer in the development of solid state pulsed power components and systems, we are able to deliver anything from discrete components to fully integrated energy transfer switches. With systems successfully delivering voltage ratings of over 50kV and pulsed currents up to 140kA, we have a wealth of experience at your disposal. Our modular design solutions based on either pulse thyristor or press-pack IGBT technology and integrating control and protection functions provide you with a flexible 'black-box' approach to energy transfer problems.

We are involved with pulsed power on a global basis, working with prestigious research organisations such as CERN, Switzerland as well as medium voltage manufacture for emerging commercial applications such as laser supplies, PUV and PEF sterilisation, magnetisation and metal forming.

Power Semiconductor Assemblies From IXYS UK

Traction Applications

With over 40 years of experience, our dedicated team of design engineers can deliver solutions to a whole range of design problems, ranging from simple trackside rectifiers to complex propulsion converters.

IXYS UK power electronic assemblies group pioneered the early development of solid state converters for traction systems in the late 1950's as part of the Westinghouse brake & signal company. Over the years we have gained an enviable reputation within the rail sector as a solution provider.

Using our experience and broad network of contacts within the industry, we are able to offer assistance in tackling issues such as; component obsolescence, improving power equipment reliability, contract maintenance of power modules, refurbishment of power electronics, upgrades to existing systems and, of course, subcontract manufacture for new projects.

Working systematically to the highest international standards, we can give your equipment a new lease of life and help protect your investment in these valuable assets.

Component obsolescence is becoming a significant problem for the rail sector as equipment design life invariably exceeds that of the modern power electronics components. Our highly skilled team of engineers are able to re-engineer older equipment to incorporate the latest technology whilst maintaining compatibility.

As equipment reached half-life, many of the major power components will reach the end of their useful life resulting in a sharp decline in equipment reliability and availability. In these circumstances we can offer a full overhaul and refurbishment program for your power electronics, from engineering analysis, test and measurement through to delivery and validation of refurbished equipment.

For larger projects such as fleet wide refits, we are able to work within a consortium of specialist international companies to ensure you have the right skills on hand to deliver turnkey solutions to your requirements. This may include system analysis, project management, risk assessment and safety case.

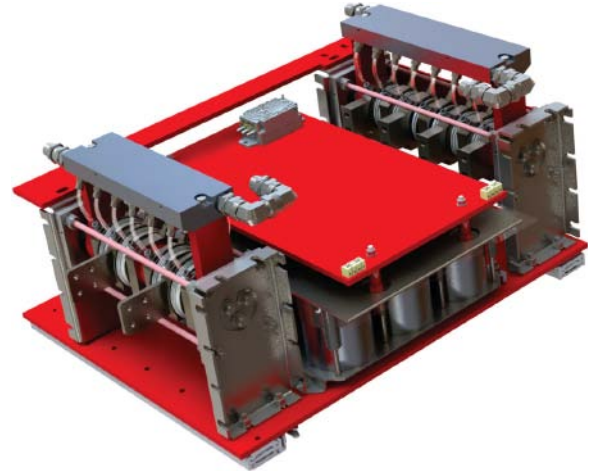

Custom assemblies – our design philosophy

From concept through development and manufacture to after sales support, we believe strongly in working closely with our customer every step of the way – extending our philosophy of teamwork beyond our own organisation.

We understand that good communication and close collaboration help us provide the very best service to our customers.

Using the latest 3D modelling techniques we can visualise concepts and check form, fit and function with virtual prototypes. Also, utilising advanced software packages, IXYS UK can carry out simulation modelling, allowing us to model pressure drops through coolers/manifolds and heat flows through heatsinks.

Whether finding solutions to complex engineering problems or simply manufacturing to your designs, you will find IXYS UK offers outstanding value for money, excellent quality and first class customer service.

By working closely together from the very start of a project we aim to provide the best solutions on time and in budget.

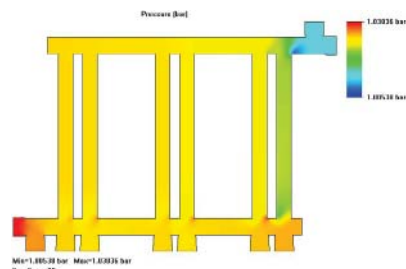
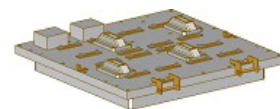
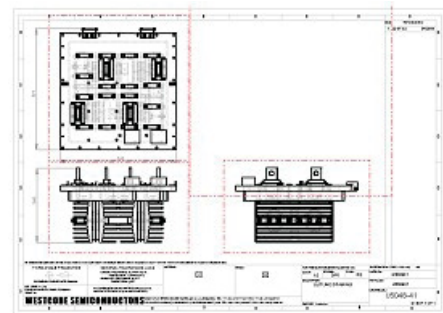

Power Semiconductor Assemblies From IXYS UK

Silicon Assemblies

A wide range of units are available, incorporating international standard outline silicon semiconductors. IXYS UK products have gained a worldwide reputation for quality in military, industrial and domestic applications.

Standard extruded aluminium heatsink profiles are used for mounting discrete semiconductor devices in various configurations, for example:

- Single-phase diode bridges with current ratings from 70 to 5710 Amps DC
- Single-phase half or fully controlled bridges from 35 to 2200 Amps DC
- Three-phase diode bridges with current ratings from 100 to 7190 Amps DC
- Three-phase half or fully controlled bridges from 45 to 3790 Amps DC
- Hexaphase single way diode assemblies from 200 to 14380 Amps DC
- Hexaphase single way thyristor assemblies from 90 to 7580 Amps DC
- AC regulators, single and three-phase from 40 to 2940 Amps RMS

Included in our standard range are solid-state, water-cooled AC regulators for resistance welding, with ratings from 315 to 3020 Amps RMS.

Also available are water cooled, single and three-phase assemblies from 1200 to 6000 Amps RMS.

All the above ranges are suitable for 440VRMS, 50Hz mains operation.

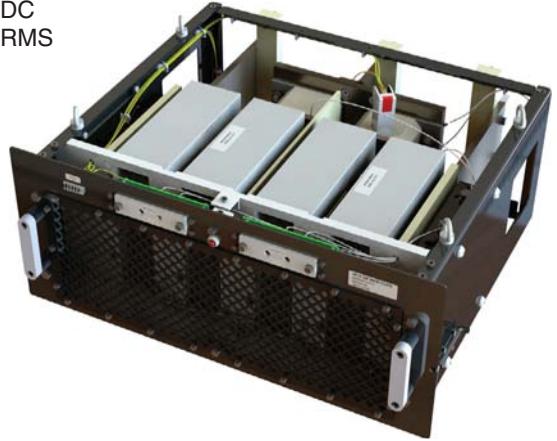

Beyond Semiconductors

Our flexible manufacturing facility is able to readily adapt to our customer's needs. In addition to power semiconductor assembly, we can offer complementary sub-assemblies to our customer's requirements, such as fuse panels and capacitor banks as well as contract manufacture to your designs.

Application and engineering support

Our highly experienced technical team is on hand to provide our customers with first class support for everything from the application of our range of discrete devices to the design and development of complex systems. We can help you from concept through design to manufacture and test, working closely with you every step of the way.

Components

To complement our range of power semiconductors and assemblies IXYS UK can offer a range of supporting components including:

- Heatsinks
- Coolers
- Mounting clamps
- Ultra-rapid semiconductor protection fuses
- Capacitors
 - Snubbers
 - Rectification
 - Specialist DC link
- Gate drive units



Westack - Modular Solutions

Single phase diode bridges										Approx. total loss $2x I_{DC}$ @ 25°C			
Assembly Part Number	I_{DC} amps Air Forced 2.5m/s			I_{FSM} amps	I_{TSM} amps	I^2t A ² s	Dimensions mm			Mass kg	Device Type and Quantity	Heat Sink Type	
	$T_a = 25^\circ C$	$T_a = 35^\circ C$	$T_a = 45^\circ C$				Fig.	W	H				D
SXB1375B	1375	1303	1230	19500		1.9×10^6	1	382	325	405	20	W2058LC (4)	B(2x83.1x180)
SXB2096B	2096	1987	1874	33000		5.45×10^6	1	382	325	405	20	W3270NC (4)	B(2x83.1x180)
SXB3442B	3442	3277	3109	53000		13.5×10^6	2	382	593	405	40	W5696VC (4)	B(2x180)
SXB4264B	4264	4051	3835	72000		22.5×10^6	2	382	593	405	40	W8405ZC (4)	B(2x180)

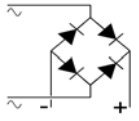

Three phase diode bridges										Approx. total loss $2.5x I_{DC}$ @ 25°C			
Assembly Part Number	I_{DC} amps Air Forced 2.5m/s			I_{FSM} amps	I_{TSM} amps	I^2t A ² s	Dimensions mm			Mass kg	Device Type and Quantity	Heat Sink Type	
	$T_a = 25^\circ C$	$T_a = 35^\circ C$	$T_a = 45^\circ C$				Fig.	W	H				D
SXB1920G	1920	1822	1721	19500		1.9×10^6	3	548	325	405	30	W2058LC (6)	B(2x83.1x180)
SXB2939G	2939	2788	2634	33000		5.45×10^6	3	548	325	405	30	W3270NC (6)	B(2x83.1x180)
SXB4869G	4869	4640	4407	53000		13.5×10^6	4	548	593	405	60	W5696VC (6)	B(2x180)
SXB5993G	5993	5701	5402	72000		22.5×10^6	4	548	593	405	60	W8405ZC (6)	B(2x180)

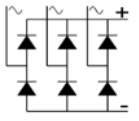

Six phase diode, single way with IPT										Approx. total loss $1.25x I_{DC}$ @ 25°C			
Assembly Part Number	I_{DC} amps Air Forced 2.5m/s			I_{FSM} amps	I_{TSM} amps	I^2t A ² s	Dimensions mm			Mass kg	Device Type and Quantity	Heat Sink Type	
	$T_a = 25^\circ C$	$T_a = 35^\circ C$	$T_a = 45^\circ C$				Fig.	W	H				D
SXB3840HEX	3840	3644	3442	19500		1.9×10^6	5	548	325	395	30	W2058LC (6)	B(2x83.1x180)
SXB5877HEX	5877	5576	5268	33000		5.45×10^6	5	548	325	395	30	W3270NC (6)	B(2x83.1x180)
SXB9737HEX	9737	9281	8813	53000		13.5×10^6	6	548	593	395	60	W5696VC (6)	B(2x180)
SXB11987HEX	11987	11401	10804	72000		22.5×10^6	6	548	593	395	60	W8405ZC (6)	B(2x180)

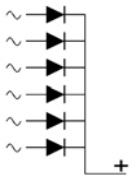

Six phase thyristor, single way with IPT										Approx. total loss $1.5x I_{DC}$ @ 25°C			
Assembly Part Number	I_{DC} amps Air Forced 2.5m/s			I_{FSM} amps	I_{TSM} amps	I^2t A ² s	Dimensions mm			Mass kg	Device Type and Quantity	Heat Sink Type	
	$T_a = 25^\circ C$	$T_a = 35^\circ C$	$T_a = 45^\circ C$				Fig.	W	H				D
SXB3529HEXT	3529	3244	2949	29600		4.38×10^6	5	548	325	395	30	N1802LC (6)	B(2x83.1x180)
SXB4649HEXT	4649	4270	3878	37000		6.85×10^6	6	548	593	395	60	N2500VC (6)	B(2x180)
SXB6240HEXT	6240	5714	5173	64000		20.5×10^6	6	548	593	395	60	N4085ZC (6)	B(2x180)

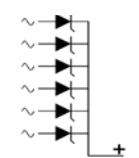

Single phase fully controlled bridges										Approx. total loss $2.5x I_{DC}$ @ 25°C			
Assembly Part Number	I_{DC} amps Air Forced 2.5m/s			I_{FSM} amps	I_{TSM} amps	I^2t A ² s	Dimensions mm			Mass kg	Device Type and Quantity	Heat Sink Type	
	$T_a = 25^\circ C$	$T_a = 35^\circ C$	$T_a = 45^\circ C$				Fig.	W	H				D
SXB1265FB	1265	1161	1054	29600		4.38×10^6	1	382	325	405	20	N1802NC (4)	B(2x83.1x180)
SXB1645FB	1645	1508	1367	37000		6.85×10^6	2	382	593	405	40	N2500VC (4)	B(2x180)
SXB2167FB	2167	1981	1790	64000		20.5×10^6	2	382	593	405	40	N4085ZC (4)	B(2x180)

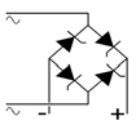

Three phase fully controlled bridges										Approx. total loss $3x I_{DC}$ @ 25°C			
Assembly Part Number	I_{DC} amps Air Forced 2.5m/s			I_{FSM} amps	I_{TSM} amps	I^2t A ² s	Dimensions mm			Mass kg	Device Type and Quantity	Heat Sink Type	
	$T_a = 25^\circ C$	$T_a = 35^\circ C$	$T_a = 45^\circ C$				Fig.	W	H				D
SXB1764FG	1764	1622	1475	29600		4.38×10^6	3	548	325	405	30	N1802NC (6)	B(2x83.1x180)
SXB2324FG	2324	2135	1939	37000		6.85×10^6	4	548	593	405	60	N2500VC (6)	B(2x180)
SXB3120FG	3120	2857	2586	64000		20.5×10^6	4	548	593	405	60	N4085ZC (6)	B(2x180)

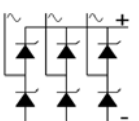

Westack - Modular Solutions

Cooling for each module section is provided by the use of a low noise 115/230 V ac fan which is protected against overloading by an integral thermal cut-out.

Surge suppression and fusing provides reliable and safe operation. Surge suppression (protecting the devices from voltage transients) and high speed fuses (to protect against short circuit) are available. Contact IXYS UK for details.

All plastic components are UL recognised and meet the requirements of the European Union Directive 2002/95/EC covering the restricted use of certain hazardous substances in electrical and electronic equipment.

Using ISO 9001 ensures that our products consistently meet customer's requirements, and that quality is consistently improved.

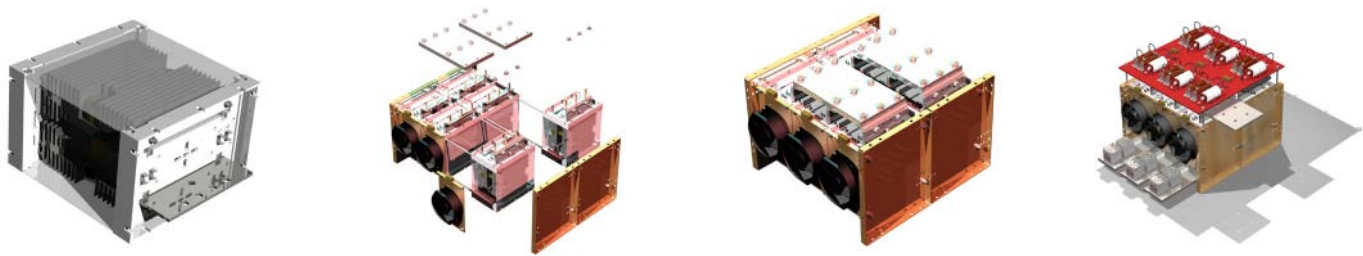

Westack - Modular Solutions are available in 6 standard configurations. others by request.

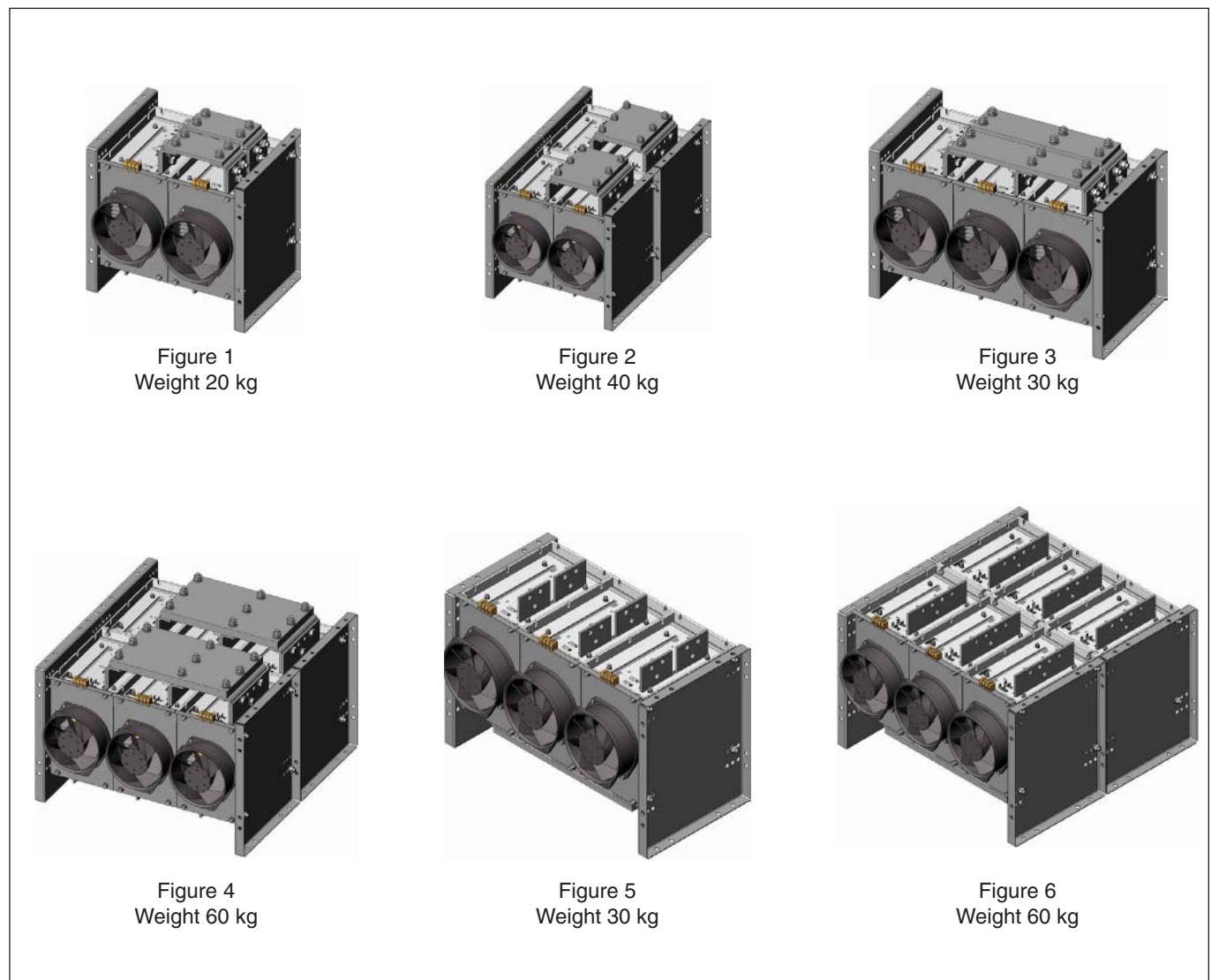

WestackLITE - Modular Solutions

A simple but highly efficient range of stacks incorporating the new **WESPACK** range of phase control thyristors.

Currently available in 3 standard configurations:

AC voltage regulators

Single-phase bridges

Three-phase bridges

These stacks can easily be modified to meet individual customer requirements.

Fully dimensioned drawings are available upon request from the Chippenham Factory.

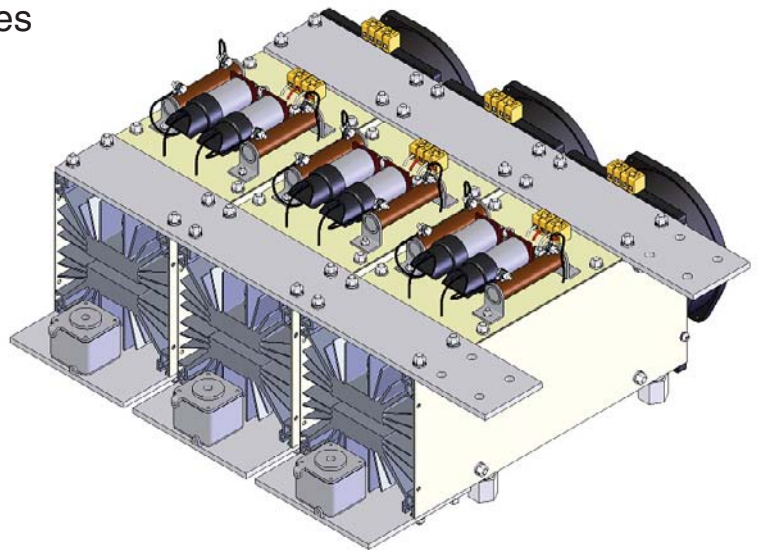

Features and Benefits

WESPACK devices provide the maximum power rating for weight and volume without compromising on quality and reliability.



Cooling is provided by means of a low noise dual voltage (230V/115V) ac fan that is protected against overloading by an integral thermal cut-out.

Surge suppression and fusing can be added to protect the devices from voltage transients and short circuits.

WestackLITE - Modular Solutions

AC regulators										Approx. total loss $1.3x I_{RMS}$			
Assembly Part Number	I _{DC} amps Air Forced 5m/s			I _{FSM} amps I _{TSM} amps	I ² t A ² s	Dimensions mm				Mass kg	Device Type and Quantity	Heat Sink Type	
	T _a = 25°C	T _a = 35°C	T _a = 45°C			Fig.	W	H	D				
SXC1195FR	1195	1098	997	19100	1.82x10 ⁶	1	168	415	212	10	N1806QK (2)	(2x150. 1x330)	
SXC1464FR	1464	1348	1227	32400	5.25x10 ⁶	1	168	415	212	10	N2367MK (2)	(2x150. 1x330)	
SXC1788FR	1788	1636	1480	50900	12.95x10 ⁶	1	168	415	212	10	N3904HK (2)	(2x150. 1x330)	

Single phase fully controlled bridges										Approx. total loss $2.5x I_{DC}$			
Assembly Part Number	I _{DC} amps Air Forced 2.5m/s			I _{FSM} amps I _{TSM} amps	I ² t A ² s	Dimensions mm				Mass kg	Device Type and Quantity	Heat Sink Type	
	T _a = 25°C	T _a = 35°C	T _a = 45°C			Fig.	W	H	D				
SXC1076FB	1076	988	897	19100	1.82x10 ⁶	2	330	415	212	20	N1806QK (4)	(2x150. 1x330)	
SXC1318FB	1318	1213	1104	32400	5.25x10 ⁶	2	330	415	212	20	N2367MK (4)	(2x150. 1x330)	
SXC1609FB	1609	1473	1332	50900	12.95x10 ⁶	2	330	415	212	20	N3904HK (4)	(2x150. 1x330)	

Three phase fully controlled bridges										Approx. total loss $3x I_{DC}$			
Assembly Part Number	I _{DC} amps Air Forced 2.5m/s			I _{FSM} amps I _{TSM} amps	I ² t A ² s	Dimensions mm				Mass kg	Device Type and Quantity	Heat Sink Type	
	T _a = 25°C	T _a = 35°C	T _a = 45°C			Fig.	W	H	D				
SXC1517FG	1517	1396	1270	19100	1.82x10 ⁶	3	492	415	212	30	N1806QK (6)	(2x150. 1x330)	
SXC1871FG	1871	1725	1573	32400	5.25x10 ⁶	3	492	415	212	30	N2367MK (6)	(2x150. 1x330)	
SXC2319FG	2319	2125	1926	50900	12.95x10 ⁶	3	492	415	212	30	N3904HK (6)	(2x150. 1x330)	

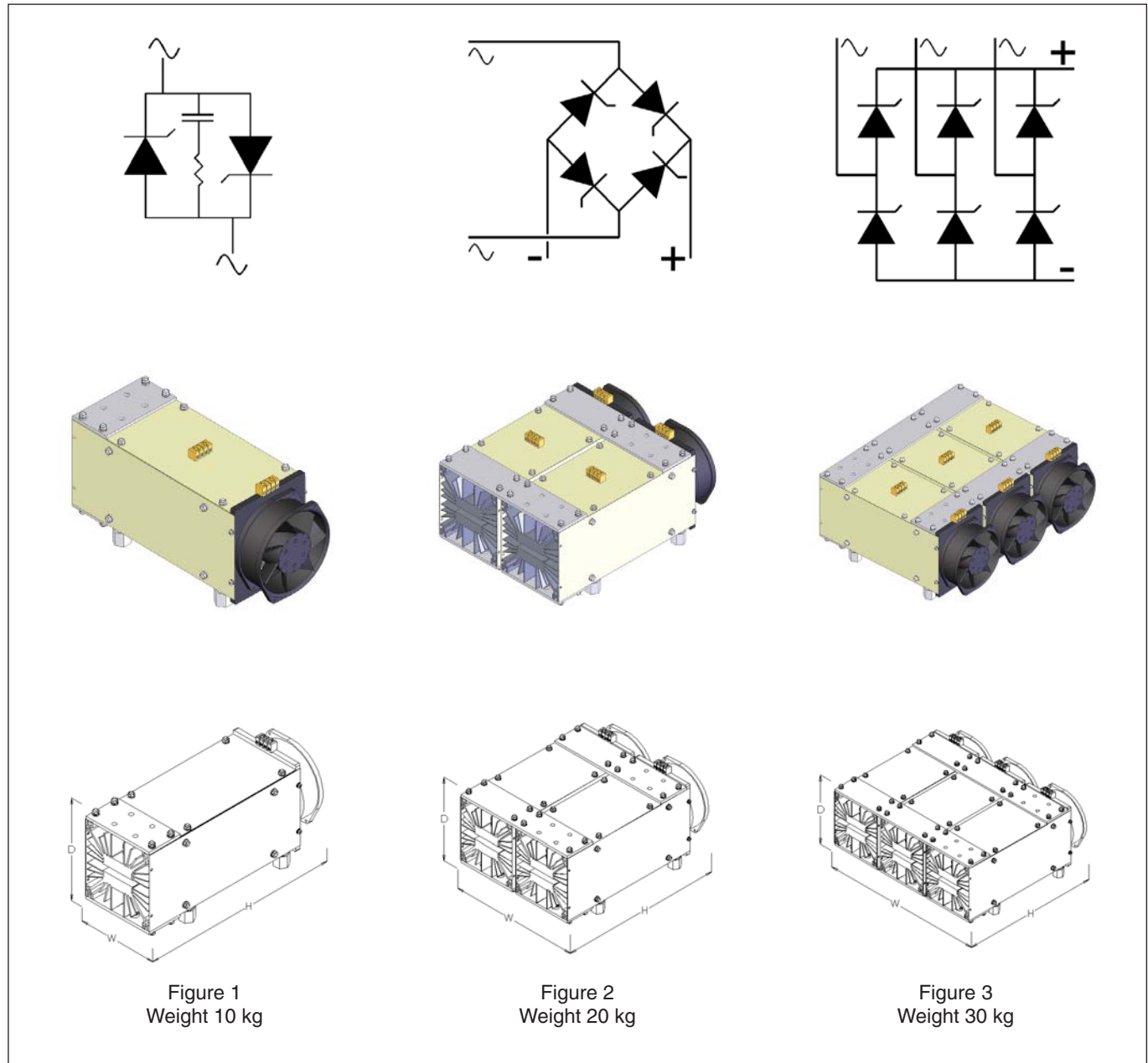

Power Semiconductor Accessories

As part of our continuing commitment to meet our customers' demands, we offer a range of products to support our high power semiconductor devices and our silicon assembly business.

The following pages show a selection of accessories available to our customers, from heatsinks and coolers, to bar or box clamps, to mounting grease!

Part No.	Old Part Number	Accessory
XSGSCX13		Press Pack Semiconductor Mounting Grease, supplied in 1kg tins
XST1000M08P	PTFE1000M8	M8 PTFE tube x 1m length insulation
XST1000M10P	PTFE1000M10	M10 PTFE tube x 1m length insulation
XST1000M12P	PTFE1000M12	M12 PTFE tube x 1m length insulation
XST1000M16P	PTFE1000M16	M16 PTFE tube x 1m length insulation
L0001YC600XXX	n/a	30mm diameter electrode Insulator Capsule
L0001QC600XXX	n/a	38mm diameter electrode Insulator Capsule
L0001NC600XXX	n/a	47mm diameter electrode Insulator Capsule
L0001HC600XXX	n/a	66mm diameter electrode Insulator Capsule
L0001ZF600XXX	n/a	73mm diameter electrode Insulator Capsule
L0001TC600XXX	n/a	75mm diameter electrode Insulator Capsule

Part No.	Old Part Number	Accessory	Type
XSL200D8WRC	U9948	200mm long single Co-Axial cable, Red / White, M5 ring terminal for Ø75 IGBT & below	IGBT
XSL200D8WRCP	U9947	200mm long double Co-Axial cable, Red / White, M5 ring terminal for Ø85 IGBT & above	IGBT
XSL220C2WRT		220mm long twisted pair, Silicone sleeve cable 16/0.2, Red / White, M4 ring terminal	Thyristor
XSL300C2WRP	U9900	300mm long pair, Silicone sleeve cable 16/0.2, Red / White, M4 ring terminal	Thyristor
XSL300C2WS	U9900 (Gate Only)	300mm long gate wire, Silicone sleeve cable 16/0.2, White, M4 ring terminal	Thyristor
XSL350C2WRP	U9723	350mm long pair, Silicone sleeve cable 16/0.2, Red / White, M4 ring terminal	Thyristor
XSL400C2WRP	U9860	400mm long pair, Silicone sleeve cable 16/0.2, Red / White, M4 ring terminal	Thyristor
XSL500C2WRP	U9855	500mm long pair, Silicone sleeve cable 16/0.2, Red / White, M4 ring terminal	Thyristor
XSL600C2WRP	U9775	600mm long pair, Silicone sleeve cable 16/0.2, Red / White, M4 ring terminal	Thyristor
XSL1000C2WRP	U9734/U9801/U9849	1000mm long pair, Silicone sleeve cable 16/0.2, Red / White, M4 ring terminal	Thyristor
XSL1000C2WRT	U9952	1000mm long twisted pair, Silicone sleeve cable 16/0.2, Red / White, M4 ring terminal	Thyristor
XSL1100C2WRT	U9779	1100mm long twisted pair, Silicone sleeve cable 16/0.2, Red / White, M4 ring terminal	Thyristor

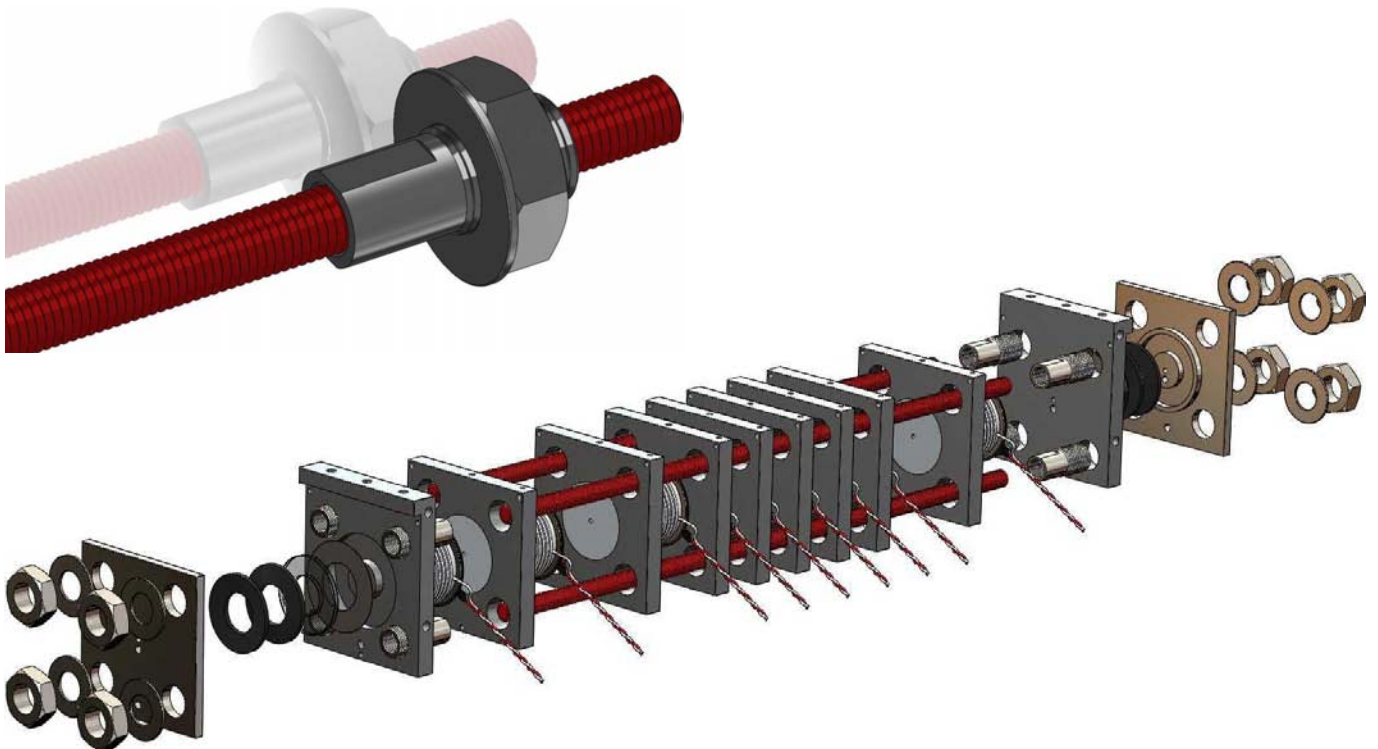

We can supply discrete parts, kits of parts or complete assemblies to satisfy your requirements. Please contact the Chippenham Factory for further information.

Standard Bar Clamps

Type Part No.	Fixing Centres mm	Rod Size	Outline	Capsule Device		T _{J Max.} °C	Outline No.
				Mounting Surface Diameter mm	Nominal Thickness mm		
XK0450DA056M XK0450DT056M XK0450SA056M	65	M8	DO-200AA/TO-200AB	19.0	13.8	190	WC2 WC3 WC1
XK0550DA056M XK0550SA056M	65	M8	GTO	29.5	16	190	WC5 WC4
XK0900DA056M * XK0900DT056M * XK0900SA056M	65	M8	Diode/Thyristor	25.1	14.6	190	WC7 WC8 WC6
XK0600DA074M XK0600SA074M	89	M10	Press-Pack IGBTs	47.0	27	190	WC10 WC9
XK1000DA074M XK1000SA074M	89	M10	Press-Pack IGBTs	47.0	27	190	WC12 WC11
XK1100DA076M	89	M10	DO-200AB/TO-200AC	34.0	26.2	190	WC13
XK1130DA076M XK1130DT076M XK1130SA076M	89	M10	DO-200AB/TO-200AC	34.0	26.2	190 190 190	WC15 WC16 WC14
XK1800DA076M XK1800DT076M XK1800SA076M	89	M10	Wespack PCT	38.0	14	190	WC18 WC19 WC17
XK2100DA076M XK2100DA076ML XK2100SA076M XK2100SA076ML	89	M10	GTO	47.0	27	190 125 190 125	WC21 WC20
XK2140DA076M * XK2140DA076ML * XK2140DT076M * XK2140DT076ML * XK2140SA076M XK2140SA076ML	89	M10	DO-200/Thyristor	47.0	26.8	190 125 190 125 190 125	WC23 WC24 WC22
XK2700DA076M XK2700DT076M XK2700SA076M	89	M10	Wespack PCT	50.0	14	190	WC26 WC27 WC25
XK2000DA114M XK2000SA114M	132	M12	Press-Pack IGBTs	75.0	26	190	WC29 WC28
XK2500DA114M XK2500SA114M	132	M12	Press-Pack IGBTs	75.0	26	190	WC31 WC30
XK2500DA116M XK2500DA116ML XK2500SA116M XK2500SA116ML	132	M12	GTO	63.0	26	190 125 190 125	WC33 WC32
XK3000DA116M * XK3000DA116ML * XK3000SA116M XK3000SA116ML	132	M12	DO-200AD/Thyristor	63.0	33	190 125 190 125	WC35 WC34
XK3500DA116M XK3500DA116ML XK3500SA116M XK3500SA116ML	132	M12	GTO	75.0	26	190 125 190 125	WC37 WC36

Standard Bar Clamps

Type Part No.	Fixing Centres mm	Rod Size	Outline	Capsule Device		T _{J Max.}	Outline No.
				Mounting Surface Diameter mm	Nominal Thickness mm		
XK4000DA116M *	132	M12	Diode/Thyristor	73.0	36.8	190	WC39
XK4000DA116ML *						125	
XK4000SA116M						190	WC38
XK4000SA116ML						125	
XK5000DA128M	146	M16	GTO	75.0	26	190	WC40
XK5000DA128ML						125	
XK7000DA128M	146	M16	Diode/Thyristor	75.0	26.6	190	WC41
XK7000DA128ML						125	
XK3060DA140ML	154	M12	Press-Pack IGBTs	85.1	26	125	WC43
XK3060SA140ML						125	WC42
XK9000SA160M	180	M16	Thyristor	99.3	35.8	190	WC44
XK9000SA160ML						125	
XK9000DA160M	180	M16	Thyristor	99.3	35.8	190	WC45
XK9000DA160ML						125	
XK6120DA180ML	196	M16	Press-Pack IGBTs	125.0	26	125	WC46
XK6120SA180ML						125	WC47
XK8000DA180ML	196	M16	Press-Pack IGBTs	132.0	26	125	WC67
XK8000SA180ML						125	WC68

* Not for new design. For new replacement part see page 177

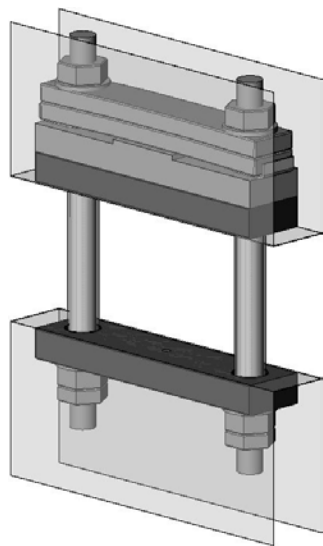

WC 18

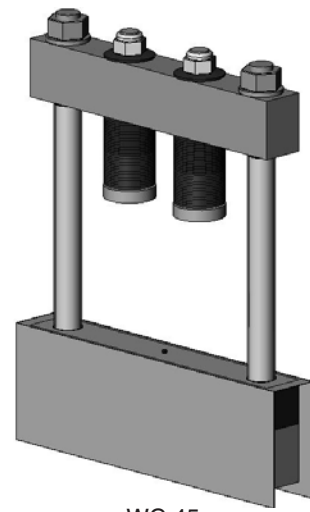

WC 45

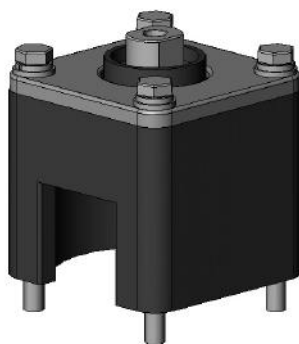

WC 50

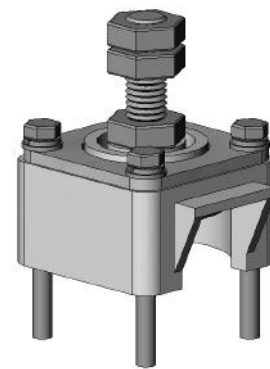

WC 48/49

Bar Clamps - new range!

Range	Part number	#### = Force kgf	Max cell dia mm	T _J MAX. °C	xxx = max Z - dim range mm	Outline
XSK042	XSK####DA042xxx	0500/0900	42	190	025-076*	WC58
	XSK####DT042xxx	0500/0900	42	190	025-076*	WC59
	XSK####DF042xxx	0500/0900	42	190	025-076*	WC60
XSK054	XSK####DA054xxx	0900	54	190	025-076*	WC58
	XSK####DT054xxx	0900	54	190	025-076*	WC59
	XSK####DF054xxx	0900	54	190	025-076*	WC60
XSK056	XSK####DA056xxx	0500/0900	56	190	038-120*	WC58
	XSK####DT056xxx	0500/0900	56	190	038-120*	WC59
	XSK####DF056xxx	0500/0900	56	190	038-120*	WC60
	XSK####DA056xxx	1500	56	190	038-120*	WC58/SP
	XSK####DT056xxx	1500	56	190	038-120*	WC59/SP
	XSK####DF056xxx	1500	56	190	038-120*	WC60/SP
XSK065	XSK####DA065xxx	0500/0900	65	190	038-120*	WC58
	XSK####DT065xxx	0500/0900	65	190	038-120*	WC59
	XSK####DF065xxx	0500/0900	65	190	038-120*	WC60
	XSK####DA065xxx	1500	65	190	038-120*	WC58/SP
	XSK####DT065xxx	1500	65	190	038-120*	WC59/SP
	XSK####DF065xxx	1500	65	190	038-120*	WC60/SP
XSK075	XSK####DA075xxx	0900/1500	75	190	038-120*	WC58
	XSK####DT075xxx	0900/1500	75	190	038-120*	WC59
	XSK####DF075xxx	0900/1500	75	190	038-120*	WC60
	XSK####DA075xxx	2200	75	190	038-120*	WC61
	XSK####DT075xxx	2200	75	190	038-120*	WC62
	XSK####DF075xxx	2200	75	190	038-120*	WC63
XSK087	XSK####DA087xxx	1500/2200	87	190	038-120*	WC61
	XSK####DT087xxx	1500/2200	87	190	038-120*	WC62
	XSK####DF087xxx	1500/2200	87	190	038-120*	WC63
	XSK####DA087xxx	3000	87	190	038-120*	WC61/SP
	XSK####DT087xxx	3000	87	190	038-120*	WC62/SP
	XSK####DF087xxx	3000	87	190	038-120*	WC63/SP
XSK103	XSK####DA103xxx	2200	103	190	038-120*	WC58/SP
	XSK####DF103xxx	2200	103	190	038-120*	WC60/SP
	XSK####DA103xxx	3200	103	190	038-120*	WC61/SP
	XSK####DF103xxx	3200	103	190	038-120*	WC63/SP
	XSK####DA103xxx	4000	103	190	038-120*	WC61/SP
	XSK####DF103xxx	4000	103	190	038-120*	WC63/SP
XSK112	XSK####DA112xxx	2800/3200/3800/4500	112	190	038-120*	WC61/SP
	XSK####DF112xxx	2800/3200/3800/4500	112	190	038-120*	WC63/SP
XSK120	XSK####DA120xxx	3800/4500/5000	120	190	050-120*	WC61/SP
	XSK####DF120xxx	3800/4500/5000	120	190	050-120*	WC63/SP
XSK126	XSK####DA126xxx	3800/4500/5000	126	190	050-120*	WC61/SP
	XSK####DF126xxx	3800/4500/5000	126	190	050-120*	WC63/SP
XSK160	XSK####DA160xxx	8000/9000	160	190	050-120*	WC61/SP
	XSK####DF160xxx	8000/9000	160	190	050-120*	WC63/SP

Bar Clamps - new range!

Range	A	A1	B	C	C1	D	E	F	G	H	Fixing
XSK042	69.85	74.89	54.00	15.88	21.04	42.00	8.64	PCF	PCF	12.70	M6
XSK054	82.55	86.04	65.00	15.88	21.04	54.00	8.62	34.93	PCF	12.70	M6
XSK056	95.25	-	70.00	25.40	-	56.00	12.19	PCF	PCF	9.53	M8
XSK065	104.39	-	79.00	25.40	-	65.00	12.19	PCF	PCF	12.70	M8
XSK075	112.78	-	89.00	25.40	-	75.00	12.19	PCF	PCF	12.70	M8
XSK087	127.00	-	102.00	25.40	-	87.00	12.19	PCF	PCF	19.05	M8
XSK103 (2200/3200)	144.78	-	118.00	25.40	36.00	103.00	12.19	PCF	PCF	19.05	M8
XSK103 (4000)	144.78	154.11	118.00	25.40	36.00	103.00	16.56	PCF	PCF	19.05	M10
XSK112	165.02	-	132.00	25.40	36.00	112.00	16.56	PCF	PCF	25.40	M10
XSK120	172.72	-	140.00	25.40	36.00	120.00	16.56	PCF	PCF	25.40	M10
XSK126	181.1	-	146	25.4	36	126	16.56	PCF	PCF	25.4	M10
XSK160	216.07	-	180	38.1	-	160	16.56	PCF	PCF	38.1	M12

Notes: PCF = Dimension is dependent on clamp force and cell height. Please consult factory.

"A1" dimension only shown where "A1" is larger than "A".

"C1" dimension only shown where "C1" is larger than "C".

All dimensions in mm.

Outline drawings
on O-01...O-35



WC 58



WC 60



WC 62



WC 59



WC 61



WC 63

Bar Clamps for WESPACK™ and GTO range

Part No.	Rod Size & Length mm	Insulator Size & Length mm	Fixing centres	Electrode Diameter	Clamp Forces	„Z“ mm	„D“ mm	Fig. No.
XSK1500DA076038	M8 x 90	M8 x 60	89.0	32	10kN to 20kN	38	27.5	WC51
XSK1500DA076076	M8 x 130	M8 x 95				76	62.5	
XSK1500DA076101	M8 x 160	M8 x 120				101	87.6	
XSK2000DA076038	M8 x 95	M8 x 60	89.0	38	13kN to 20kN	38	25.9	WC52
XSK2000DA076076	M8 x 130	M8 x 95				76	61.0	
XSK2000DA076101	M8 x 160	M8 x 120				101	85.9	
XSK3000DA076038	M8 x 100	M8 x 65	89.0	50	25kN to 31kN	38	26.2	WC53
XSK3000DA076076	M8 x 130	M8 x 100				76	56.1	
XSK3000DA076101	M8 x 160	M8 x 125				101	86.1	
XSK3400DA076038	M8 x 100	M8 x 65	89.0	50	27kN to 34kN	38	24.6	WC54
XSK3400DA076076	M8 x 140	M8 x 105				76	64.5	
XSK3400DA076101	M8 x 160	M8 x 130				101	89.7	
XSK3800DA116M076	M10 x 150	M12 x 100	132.0	66	32kN to 38kN	76	59.7	WC55
XSK3800DA116M101	M10 x 180	M12 x 125				101	84.6	
XSK4400DA116M076	M10 x 150	M12 x 105	132.0	68	36kN to 44kN	76	63.0	WC56
XSK4400DA116M101	M10 x 180	M12 x 130				101	87.9	
XSK6000DA116M076	M10 x 150	M12 x 105	132.0	75	50kN to 60kN	76	59.9	WC57
XSK6000DA116M101	M10 x 180	M12 x 130				101	84.8	

Note: 1 Kgf = 9.8 Newtons
 $T_{MAX} = 190^{\circ}C$

Outline drawings are available from pages O-01...O-35



WC51

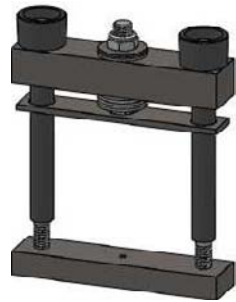

WC52

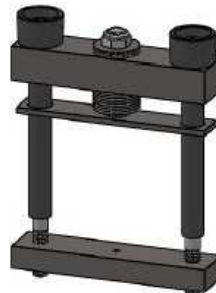

WC53

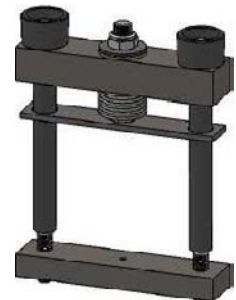

WC54

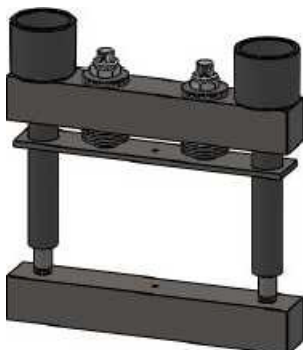

WC55

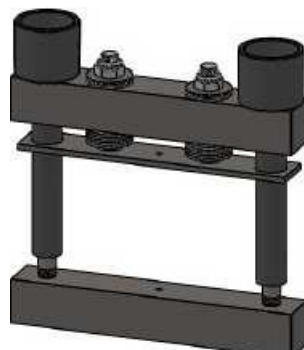

WC56

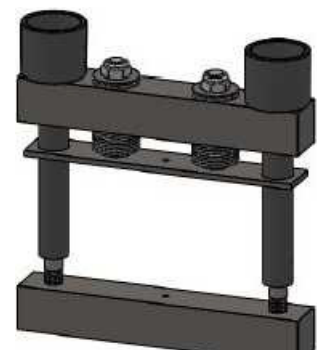

WC57

Box Clamps

Part No.	Moulded Box Style	Fixing Centres mm	Rod Size	Capsule Device			Outline Ref.
				Outline	Mounting Surface Ø mm	Nominal Thickness mm	
XK0450BA019M XK0450BB019M	Injection Compression	50 PCD	M5x50 Bolts	W1 / W8 / W90	19.0	13.8	WC48
XK0450BA025M XK0450BB025M	Injection Compression	50 PCD	M5x50 Bolts	W2 / W58	25.1	14.6	WC49
XK1000BA025M	Injection	50 PCD	M5x50 Bolts	W91	25.1	14.0	WC49
XK1500BA034M	Injection	70 PCD	M6x50 Bolts	W4 / W10 / W92	34.0	26.2	WC50

Note: 1 Kgf = 9.8 Newtons

Outline drawings are available from pages O-01...O-35

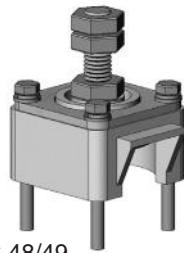

WC 48/49

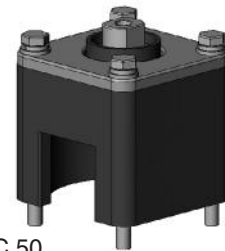

WC 50

Heatsinks

Part No.	Weight Kg/m	Periphery mm	Area mm ²	Fig.
XSFGxxxxAN	8.1	1059	2979	WH1
XSFGAxxxxAN	15.6	1682	5867	WH2
XSFHxxxxAN	12.7	1684	4655	WH3
XSFTxxxxAN	20	2065	7573	WH4
XSFTBxxxxAN	29	2467	10905	WH5
XSFTCxxxxAN	28	2544	10561	WH6
XSFLPxxxxAN	30	6620	11172	WH7
XSF46xxxxAN	20	2822	7411	WH8
XSF30xxxxAN	Dimensions 125mm x 125mm x 4 vanes			

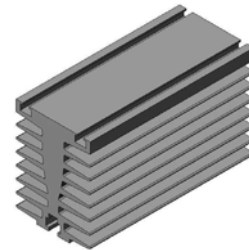

WH1

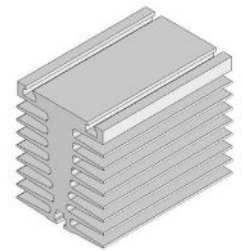

WH2

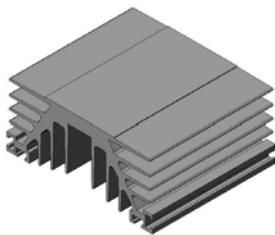

WH3

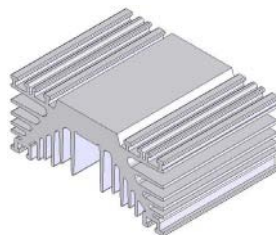

WH4

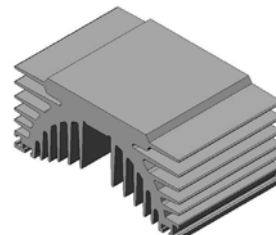

WH5

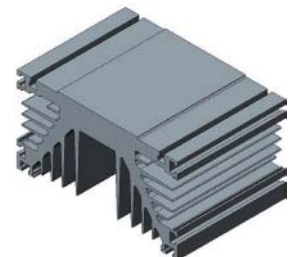

WH6

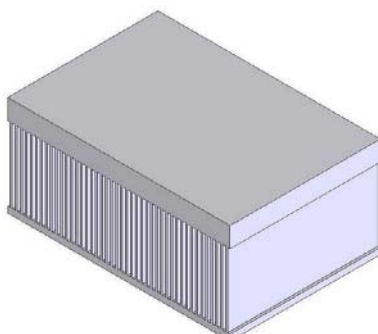

WH7

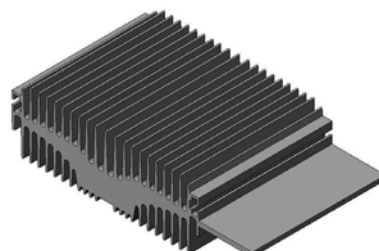

WH8

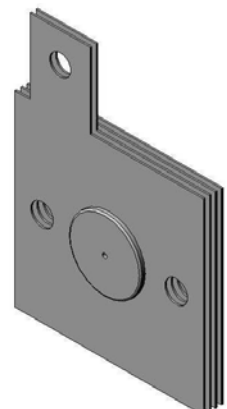

WH9

Coolers

Part No.	Weight kg	Cooler Thickness mm	Busbar Thickness mm	Description	Fig. No.
XW076NC16A	0.418	16	N/A	47mm WC Cu	WCL2
XW076NC16B		16		47mm WC Cu with Busbar (10mm Hose)	WCL1
XW076NC16BS		16		47mm WC Cu with Busbar + spirol pins fitted (10mm Hose)	WCL1
XW076NC16BT	0.612	16	6.4	47mm WC Cu with Busbar + thermostat hole (10mm Hose)	WCL1
XW076NC16C		16		47mm WC Cu with Busbar (½" Hose)	WCL1
XW076NC16CT		16		47mm WC Cu with Busbar + thermostat hole (½" Hose)	WCL1
XW076NC16R	0.581	16	6.35	47mm WC Cu reversed with Busbar	WCL12
XW076NC16W	0.400	16	N/A	47mm WC Cu reversed	WCL13
XW116ZC20A	1.300	20	N/A	73mm WC Cu	WCL4
XW116ZC20B	1.750	20	10	73mm WC Cu with Busbar	WCL3
XW116ZC20C	2.120	20	10	73mm WC Cu with alt. Busbar	WCL5
XW116ZC20R	1.672	20	10	73mm WC Cu reversed with Busbar	WCL14
XW116ZC20W	1.119	20	N/A	73mm WC Cu reversed	WCL15
XW127EC25A	1.650	25	N/A	85mm WC Cu Helix	WCL16
XW127EC25B	2.200	25	8	85mm WC Cu with Busbar Helix	WCL17
XW127EA25A	0.500	25	N/A	85mm WC Al Helix	WCL16
XW127EA25B	0.650	25	8	85mm WC Al with Busbar Helix	WCL17
XW160FC25A	3.620	25	N/A	100mm WC Cu	WCL6
XW160FC25B	4.520	25	10	100mm WC Cu with Busbar	WCL7
XW180GC34A	4.920	34	N/A	125mm WC Cu Helix	WCL11
XW180GC34B	5.950	34	10	125mm WC Cu with Busbar Helix	WCL10
XW180GA34A	1.500	34	N/A	125mm WC Al Helix	WCL11
XW180GA34B	1.800	34	10	125mm WC Al with Busbar Helix	WCL10
XW180BA34E	1.550	34	N/A	132mm WC Al Helix	WCL19
XW180BA34F	1.850	34	10	132mm WC Al with Busbar Helix	WCL20
XW270QA25A	2.941	25	N/A	270 x 190mm WC Al Cold Plate	WCL9



WCL2



WCL4

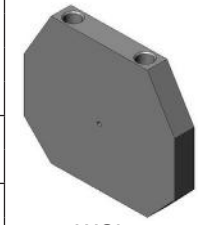

WCL8

Outlines on pages O-01...O-35



WCL1



WCL3



WCL5

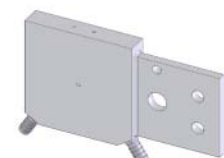

WCL6

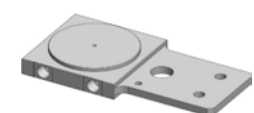

WCL7

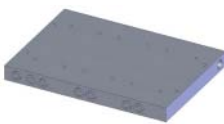

WCL9 -WS65

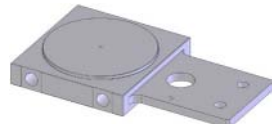

WCL10



WCL11

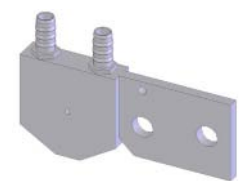

WCL12 -WS71-1

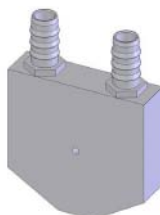

WCL13 -WS71-2

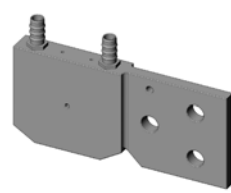

WCL14 -WS72-1

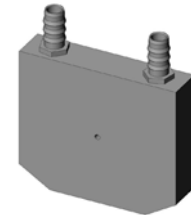

WCL15 -WS72-2

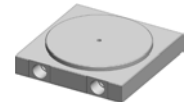

WCL16

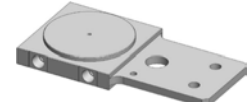

WCL17



WCL18

Part No.	Cooler Accessories
XSNM12H10S	M12 Cooler Connection, 10mm Hose & Stainless Steel material
XSNM12H12S	M12 Cooler Connection, 12mm Hose & Stainless Steel material

Power Semiconductor Chips

Littelfuse IXYS offers a wide range of power semiconductor dies for a multitude of applications.

Bipolar Chips	V_{RRM} / V_{DRM} V	$I_{F(AV)M} / I_{T(AV)M}$ A	t_{rr} ns
Schottky Diodes	8 - 200	5 - 300	-
HiPerFRED™ (Low Leakage)	200 - 1200	10 - 150	30 - 40
Sonic™ Fast Recovery Diodes	600 - 1800	5 - 150	30 - 60
FRED™ (Low Forward Voltage Drop)	200 - 1200	10 - 150	40 - 60
Semi-Fast Diodes	1200 - 1600	15 - 60	60 - 100
Rectifier Diodes	1200 - 2200	10 - 400	-
Phase Control Thyristors	800 - 2200	5 - 300	-

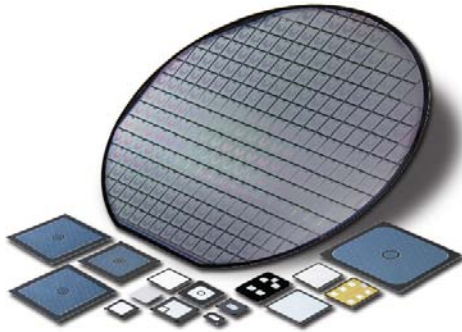

Mode of Shipment:

- in wafer form, unsawn, electrically tested, rejects are inked
- sawn wafer on foil, electrically tested, rejects are inked
- known good die in tray (Waffle Pack)
- customized die sizes / geometry on request

For chip sales please see:

<https://www.littelfuse.com/products/power-semiconductors>

Direct Copper Bonded Ceramic Substrates

DCB Ceramic Substrates (Al₂O₃)

Littelfuse IXYS manufactures Direct Copper Bonded substrates on aluminum oxide (Al₂O₃) base. DCB ceramic substrates form the basis for new product ideas and electronic developments with a high degree of integration.

- carriers for semiconductor chips and connection clips
- circuits similar to that on a PC board
- electrical isolator for separating „current paths“ from „heat paths“
- transfer medium for heat dissipation from active parts into heat sink

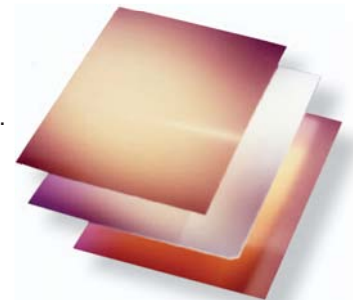

Standard bonded DCB panel dimensions are:

Unclad aluminum oxide ceramic			
Al ₂ O ₃ content		> 96	%
dimensions		138x210, 138x190.5, 115x165*	mm
usable area	max.	130x200, 130x180, 107x156*	mm
thickness		0.63, 0.38, 0.25	mm
arc through voltage		10	kV
thermal conductivity		> 24	W/m · K
Conduction layers - both sides			
copper thickness		0.5, 0.3 (< 0.3 on request)	mm
conductor width	min.	0.5, 0.3 +/- 0.2	mm
conductor spacing	min.	0.4 +/- 0.2	mm
spacing conductor/edge of ceramic	min.	0.35 +/- 0.2	mm
surface finishes available		bare copper; nickel plated; nickel + gold plated	
peel-off resistance (90° peel test)		>6	N/mm
DCB ceramic substrate			
application temperature range		-55...+850	°C
resistant to hydrogen	max.	400	°C
thermal expansion coefficient	to typ.	7.4 x 10 ⁻⁶	K ⁻¹

- DCB parts are available as:
- bonded plate
 - bonded and patterned plate
 - prelasered, unbroken plate
 - individuale substrates
 - customer specific substrates on request



* = (for 0.25 mm thk.)

Application Notes Highlights

further information and downloads see www.ixys.com

Power Factor Correction	
IXAN0001	3-Phase PFC using Vienna Rectifier Approach and Modular Construction for Improved Overall Performance, Efficiency and Reliability
IXAN0002	Single and Three-Phase Rectifiers with Active Power Factor Correction for Enhanced Mains Power Quality
IXAN0003	Rectifiers with Power Factor Correction
IXAN0004	Design and Experimental Investigation of a Three-Phase, High Power Density, High Efficiency, Unity Power Factor PWM (VIENNA) Rectifier Employing a Novel Integrated Power Semiconductor Module
IXAN0005	Status of the Techniques of Three-Phase Rectifier Systems with Low Effects on the Mains
MOSFETs and IGBTs Drivers	
IXAN0012	MOSFET/IGBT Drivers - Theory and Applications
IXAN0011	Driving Your MOSFETs Wild to Obtain Greater Efficiencies, Power Densities and Lower Overall Cost
BiMOSFETs Applications	
IXAN0013	Capacitor Charge/Discharge Circuits, utilizing High Voltage IGBTs and ZCS Resonant Mode Techniques
IXAN0014	Comparative Performance of BiMOSFETs in Fly-back Converter Circuits
IXAN0015	Use of BiMOSFETs in Modern Radar Transmitters
IXAN0016	IXBH40N160 BiMOSFET Developed for High Voltage and High Frequency Applications
IXAN0017	New 1600V BiMOSFET Transistors Open Up New Applications
Automotive Applications	
IXAN0018	A High Current Dual Inline Packaged Trench MOSFET Three Phase Full Bridge as Contribution to Automotive System Integration
IXAN0019	High Power TrenchMOSFETs Solutions in Automotive Designs
IXAN0020	Power Electronic Supply for Automotive Starter Generator
IXAN0021	New Trench Power MOSFETs in Isolated Packages
Isolation Techniques, Mounting, Soldering and Cooling	
IXAN0022	Capitalizing on the Advantages of ISOPLUS Products
IXAN0023	General Mounting Instructions
IXAN0025	ISOPLUS-The Revolution in Discrete Isolation Technique
IXAN0026	Combining the Features of Modules and Discretes in a New Power Semiconductor Packages
IXAN0028	The Revolution in Discrete Isolation Technique
IXAN0030	Surface Mount Soldering Recommendations for TO-263 and TO-268 case styles
IXAN0031	New ISOPLU247 Power Package Features 2500V Internal Isolation Revolutionary Approach Improves Thermal Conductance and Reliability
IXAN0071	The SMPD Package and its Mounting Instructions
Power Modules	
IXAN0034	Recommended Use of the Integrated NTC Thermistor Temperature Sensor in IXYS Power Modules
IXAN0035	Mounting Instructions for _A7, _E7, _A8 and _E8 Module Series
IXAN0036	Investigations on Electromagnetic Compatibility of Power Semiconductor Modules Integrated in a Module
IXAN0037	Power Cycle Capability of solder contact DCB-Modules
FREDs and Schottky Diodes	
IXAN0042	Is the Lowest Forward Voltage Drop Schottky Diode Always the Best Choice?
IXAN0043	Input Rectifiers with Semifast Diodes for DC link.
IXAN0044	Characteristics and Applications of Fast Recovery Epitaxial Diodes.
IXAN0060	Optimized Ultra Fast Diodes for Switching Applications
Power MOSFETs	
IXAN0057	Series Operation of MOSFET and IGBT Switches
IXAN0061	Power MOSFET Basics
IXAN0062	IXYS Power MOSFET Products
IXAN0063	Application note on Depletion-mode
IXAN0064	IXYS P-Channel MOSFET
IXAN0065	IXYS Power MOSFET Datasheet Parameters Definition
IXAN0068	Linear Power MOSFETS Basic and Application
IXAN0069	Synchronous DC to DC Converter Design
IGBTs	
IXAN0063	IGBTs
IXAN0070	Drive with the IXYS XPT IGBT
IXAN0072	Discrete 600V GenX3 XPT IGBTs

Dimensions in mm and inches (1 mm = 0.0394")

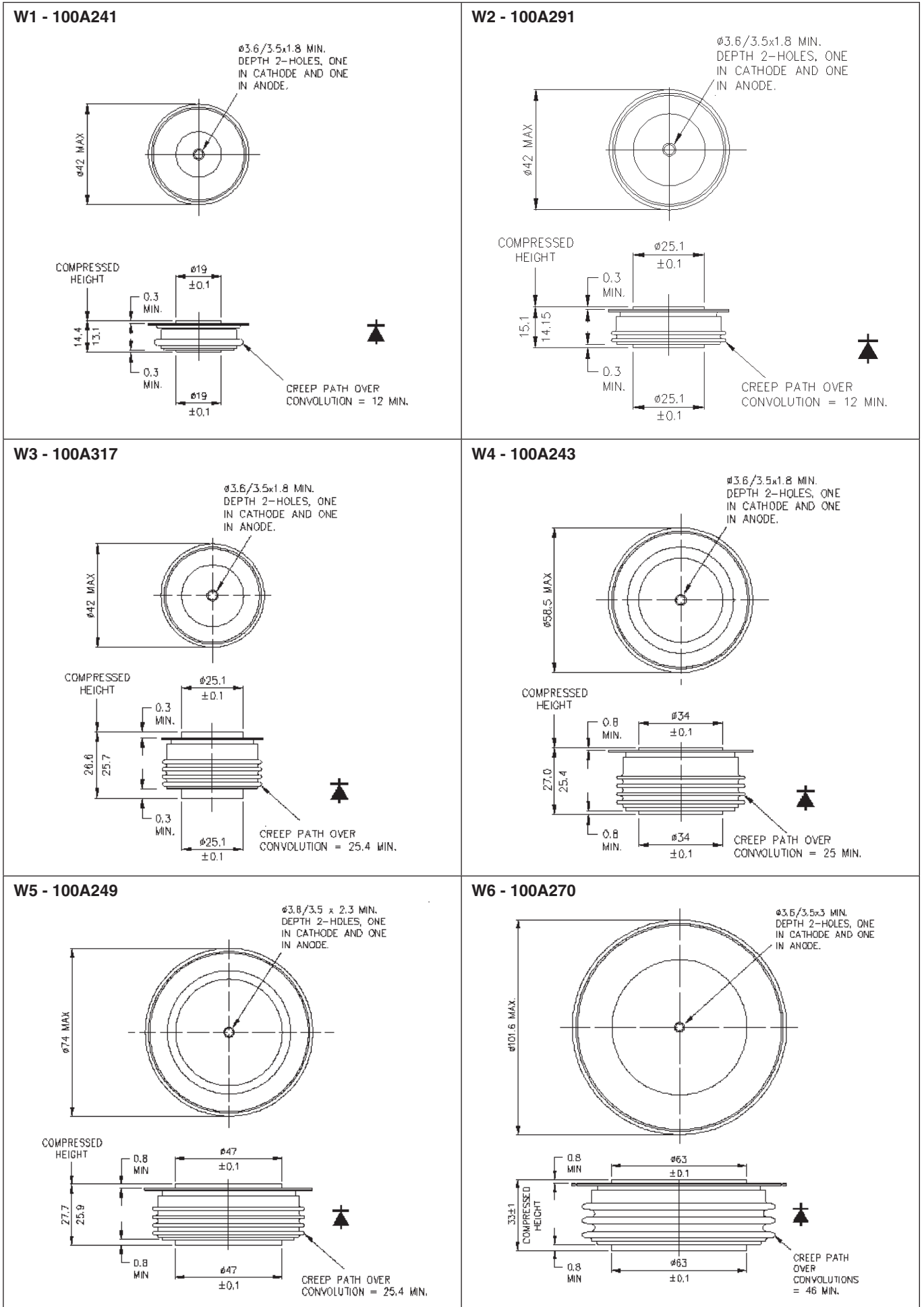

Dimensions in mm and inches (1 mm = 0.0394")

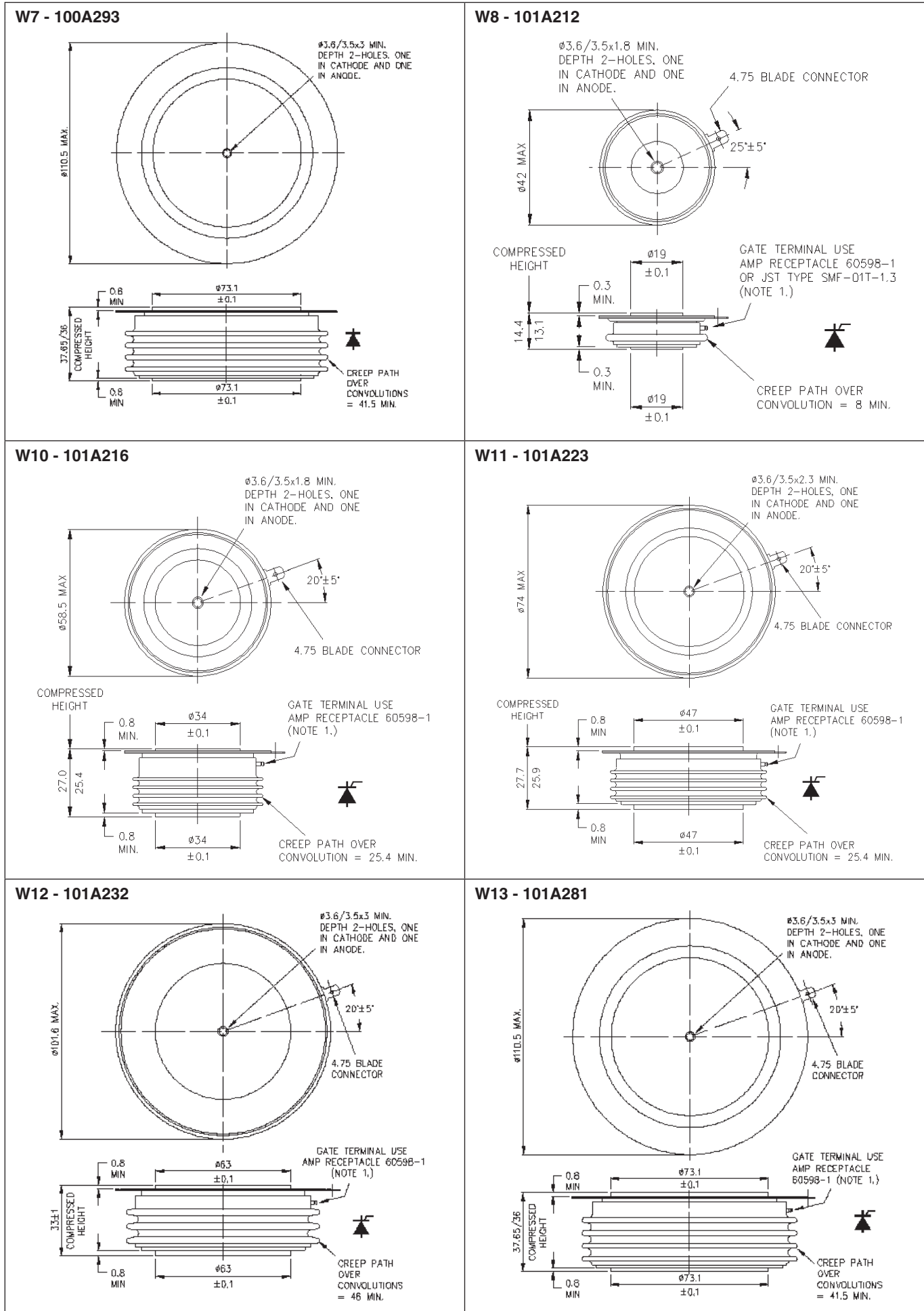

Dimensions in mm and inches (1 mm = 0.0394")

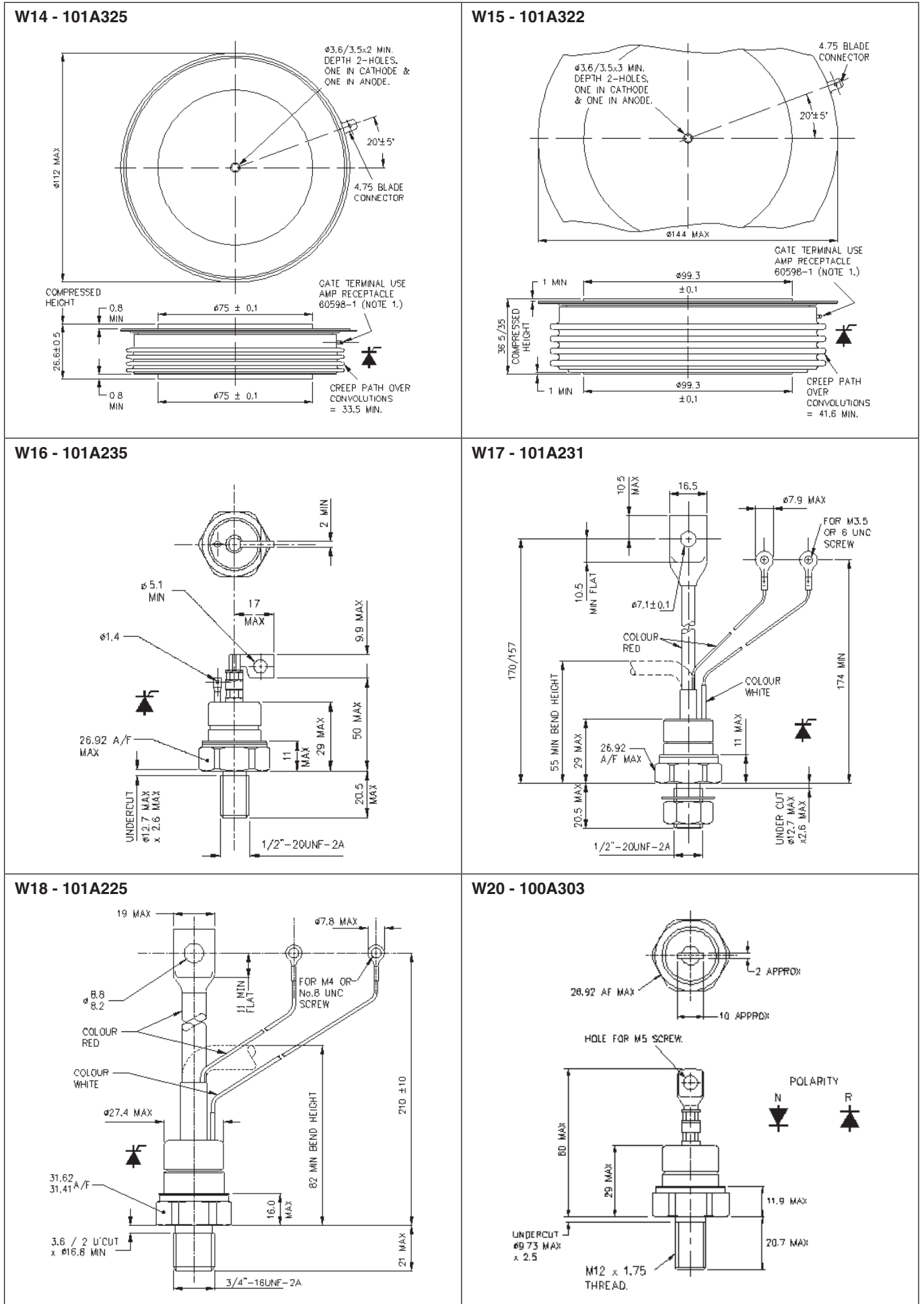

Dimensions in mm and inches (1 mm = 0.0394")

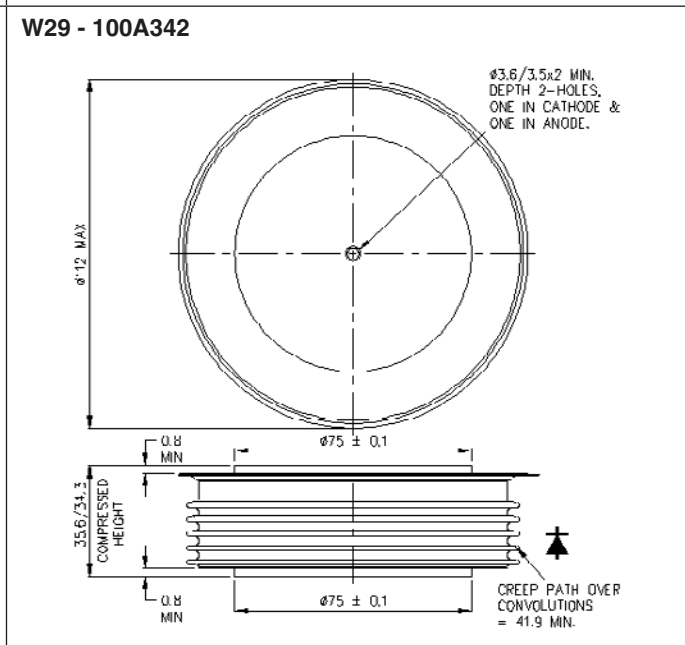
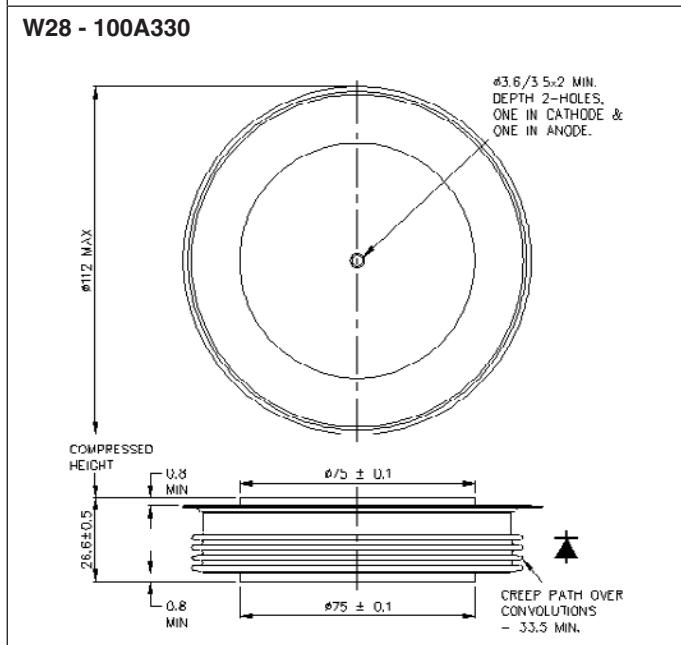
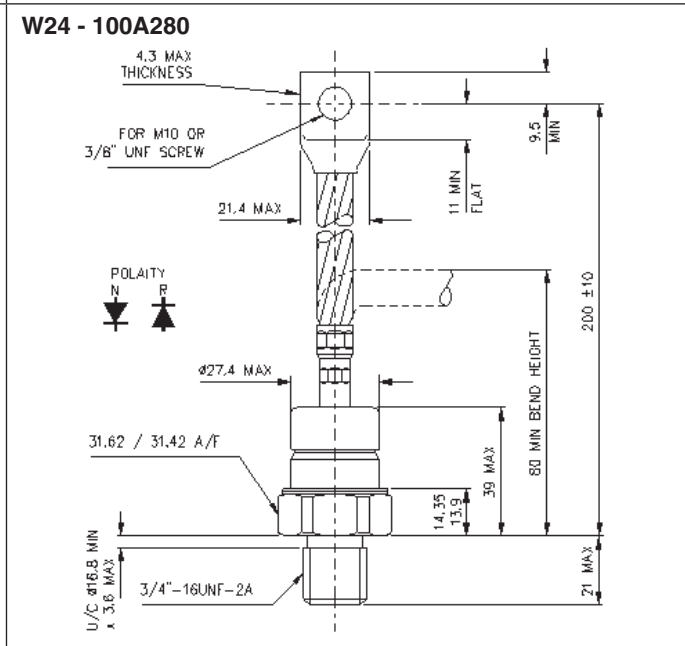
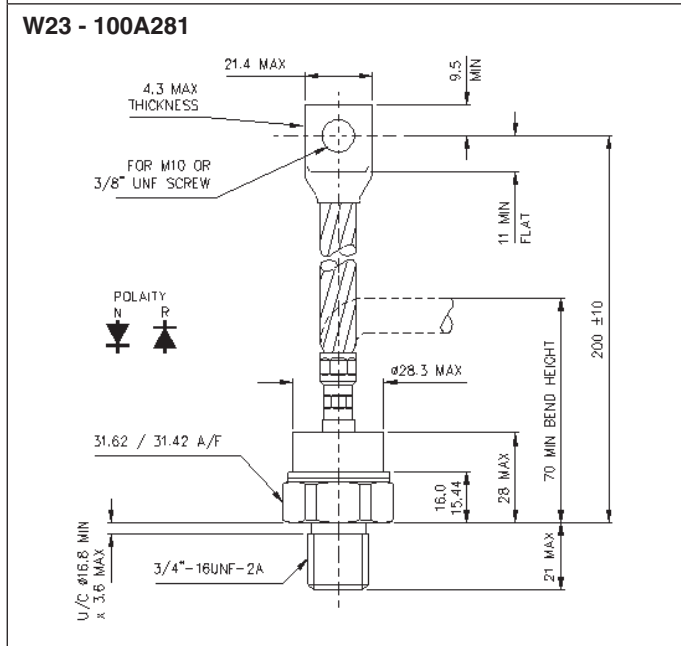
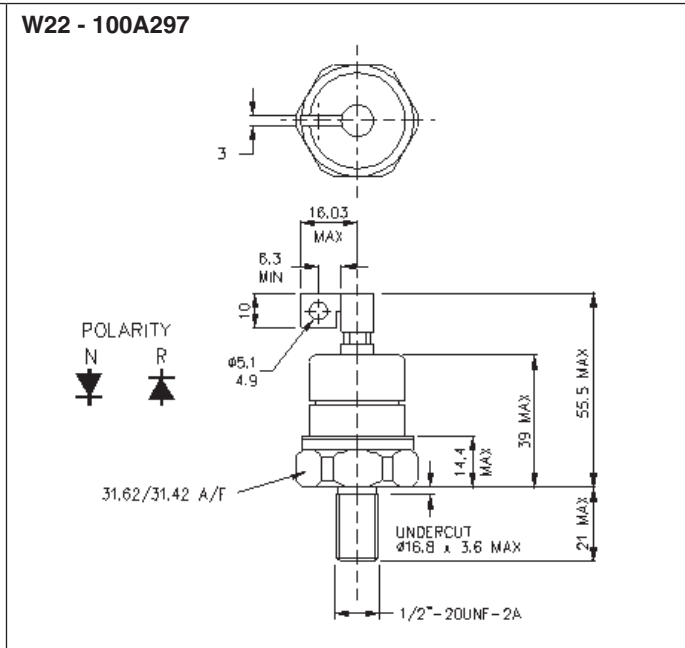
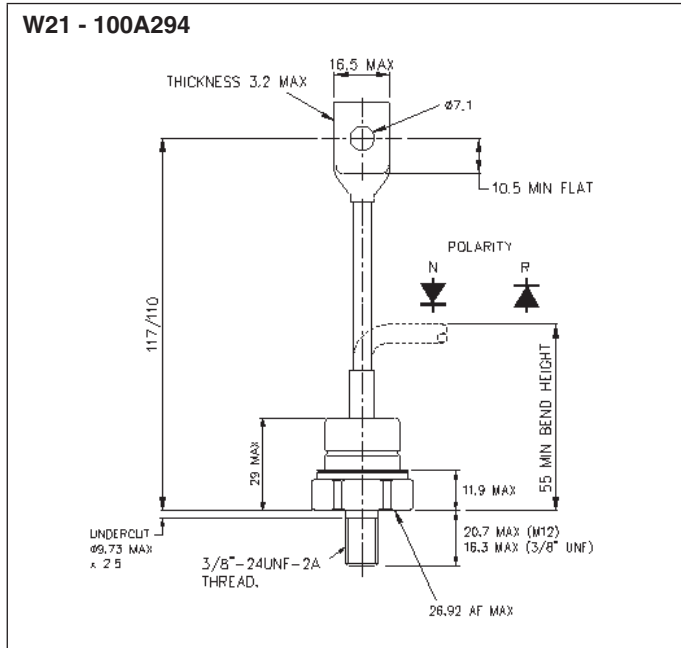

Dimensions in mm and inches (1 mm = 0.0394")

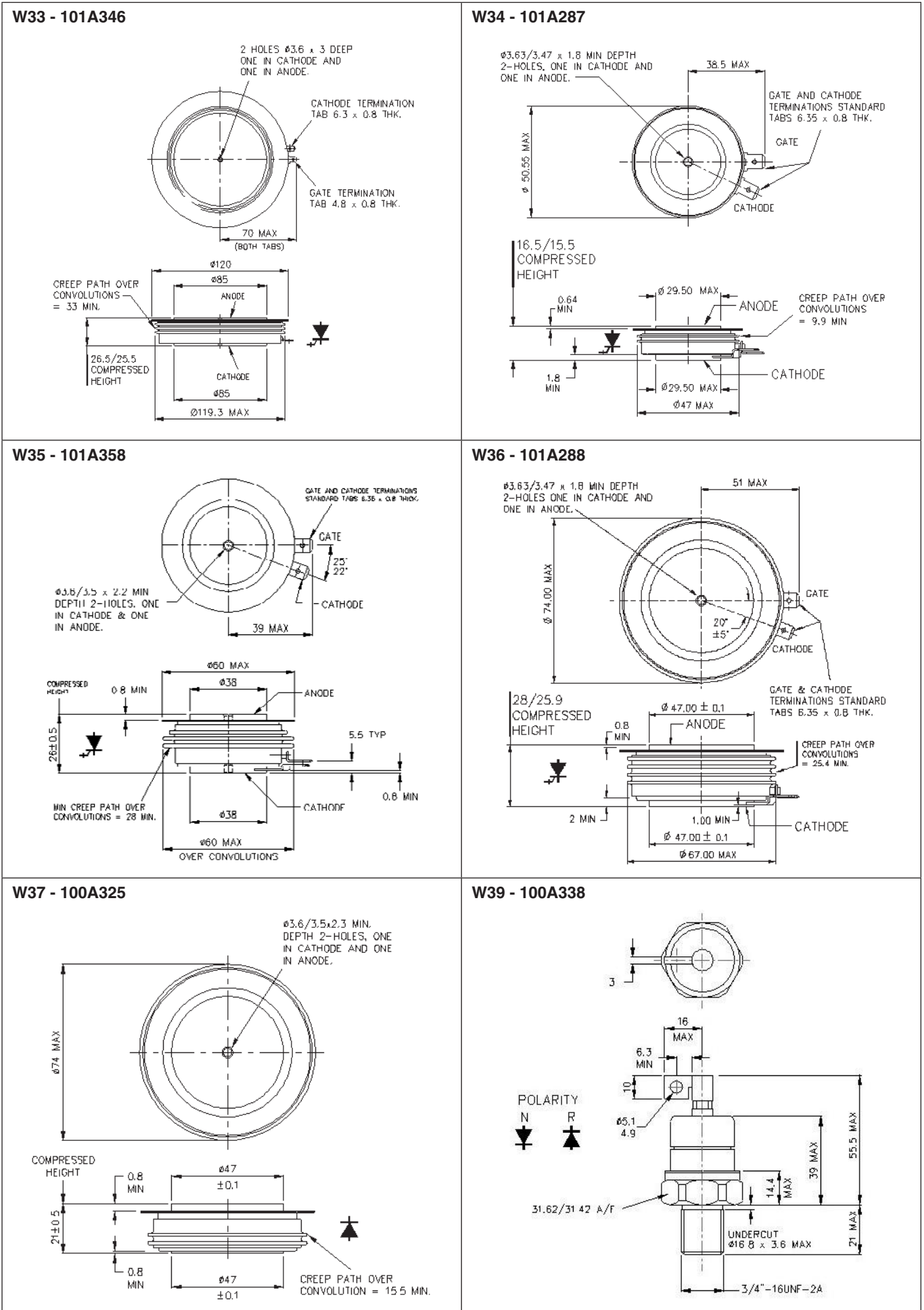

Dimensions in mm and inches (1 mm = 0.0394")

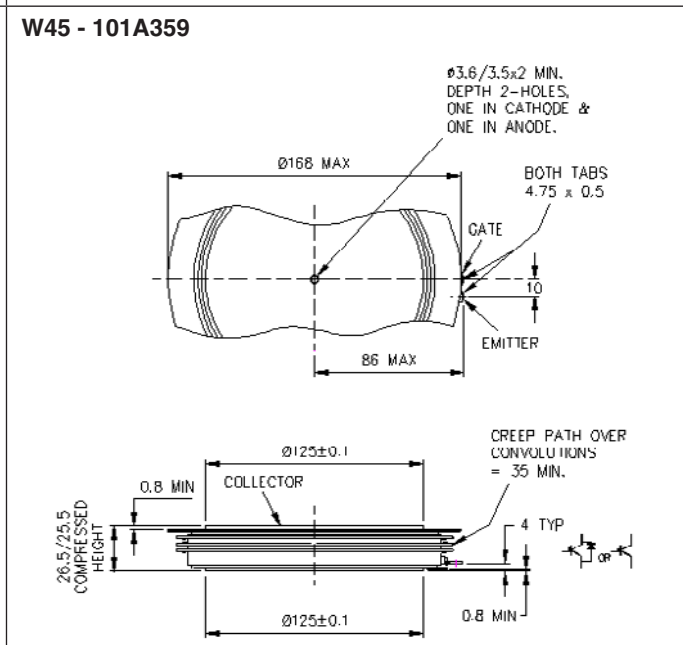
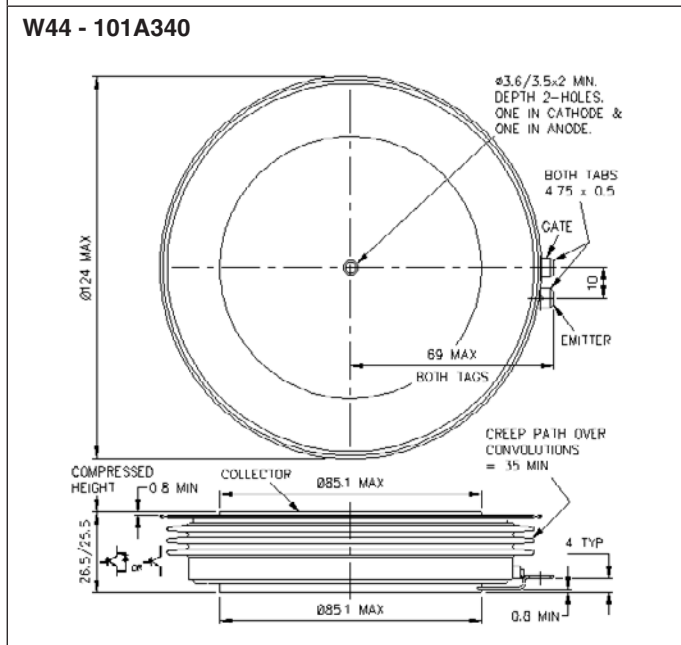
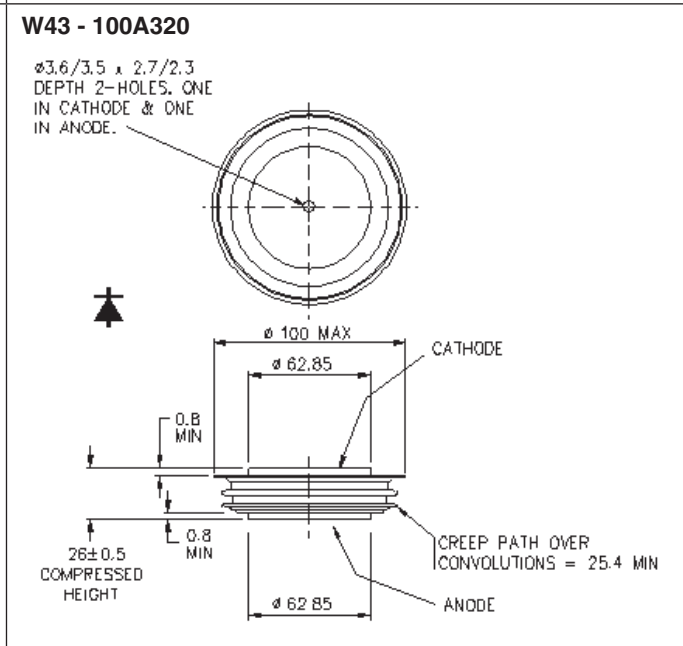
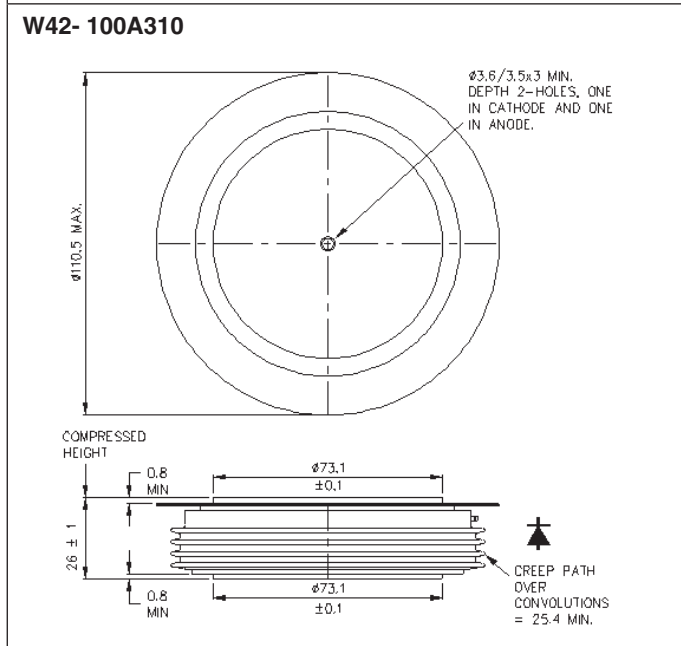
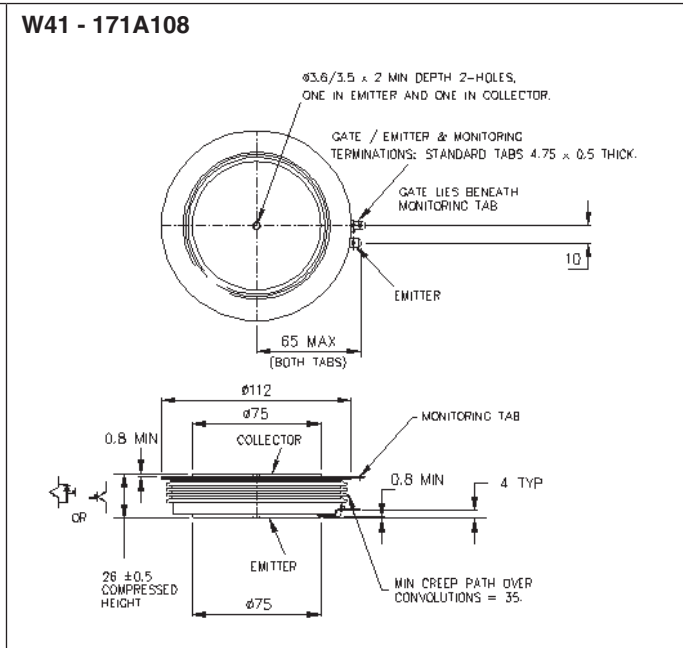
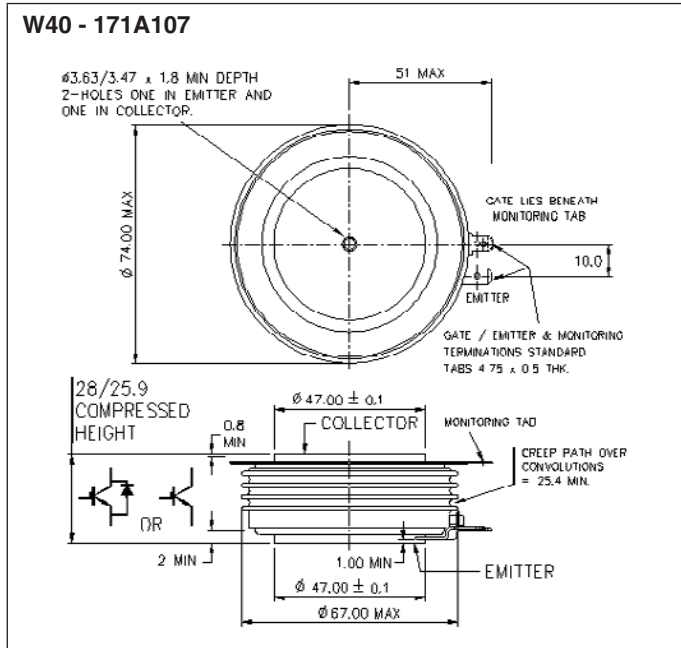

Dimensions in mm and inches (1 mm = 0.0394")

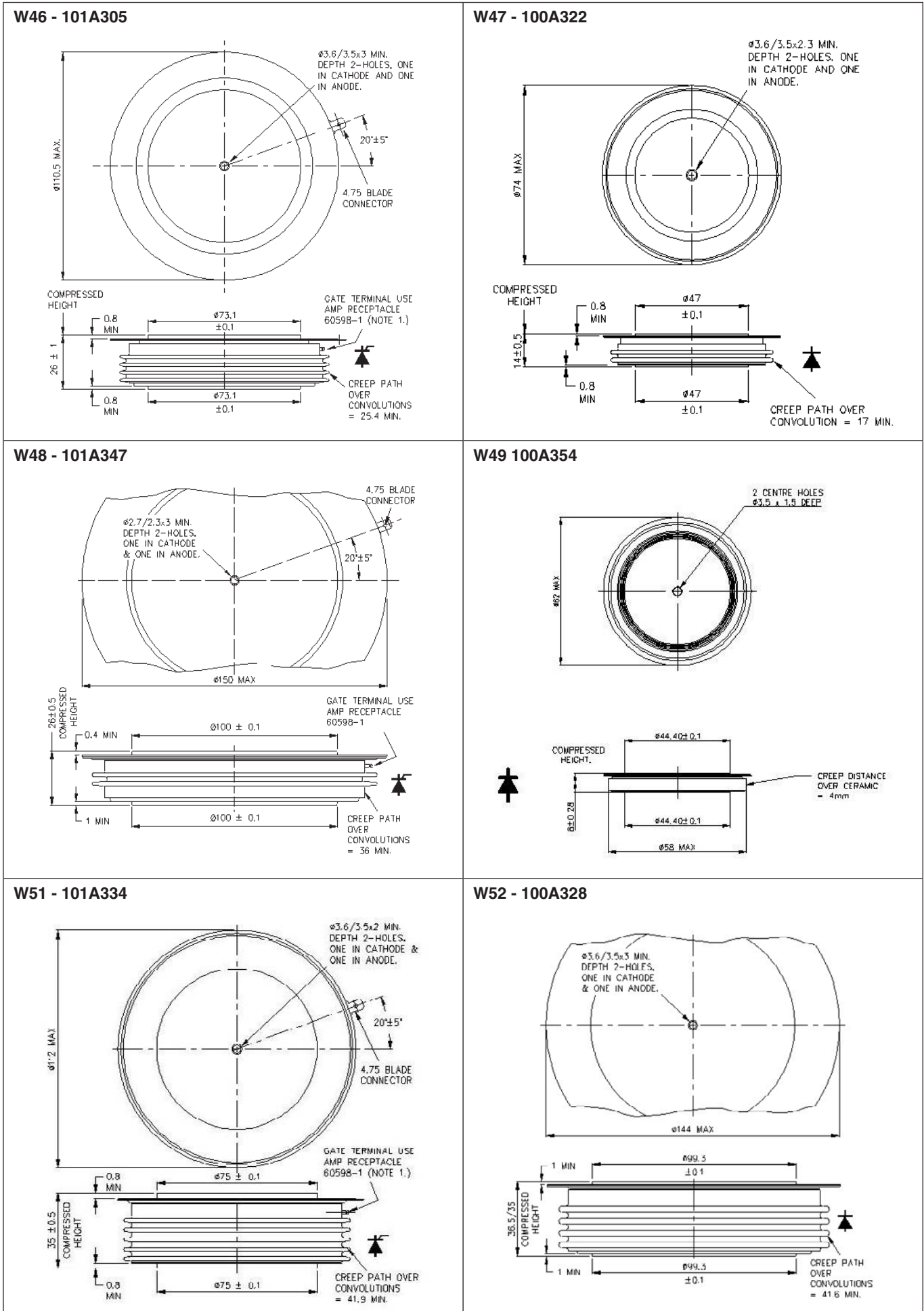

Dimensions in mm and inches (1 mm = 0.0394")

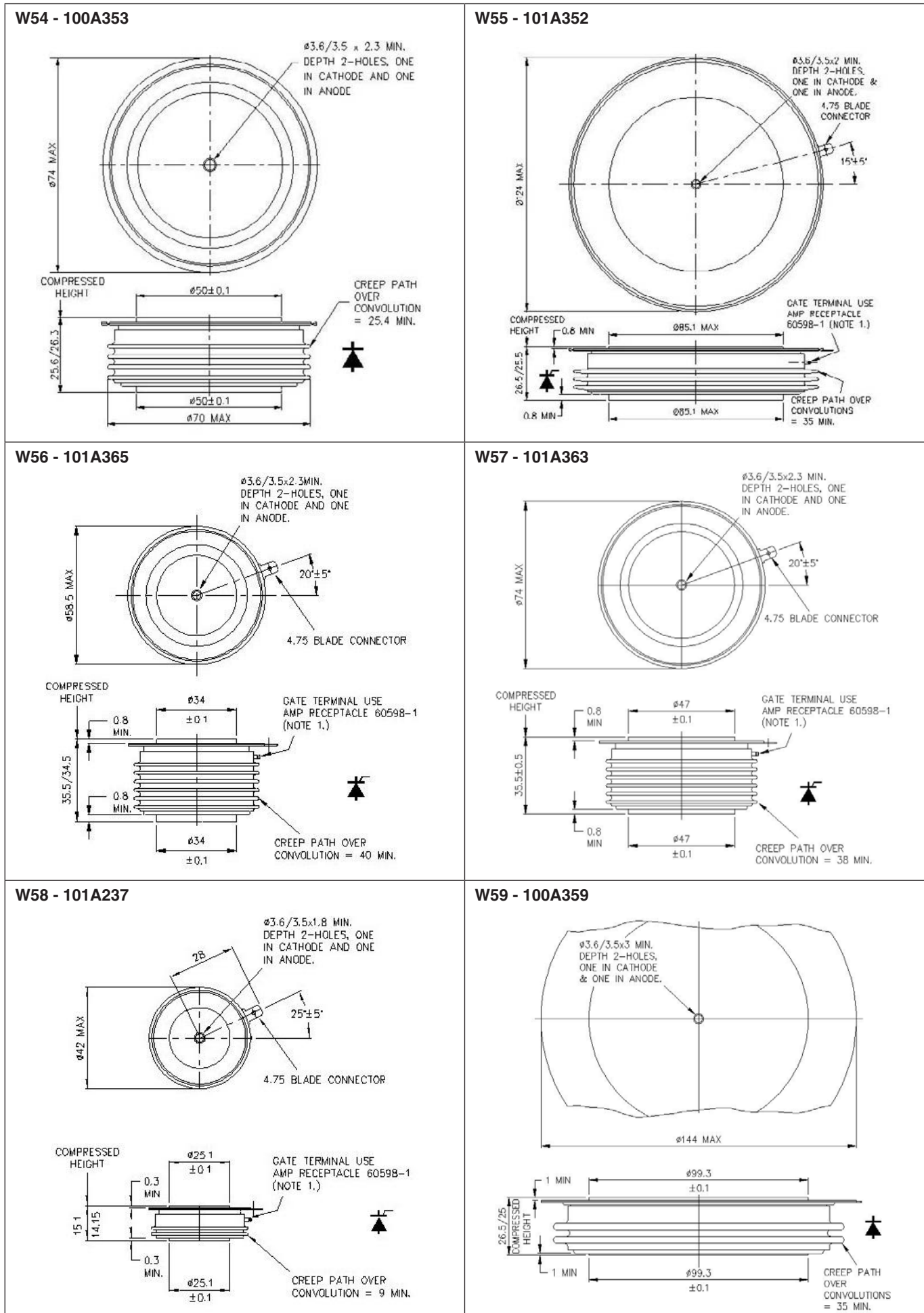

Dimensions in mm and inches (1 mm = 0.0394")

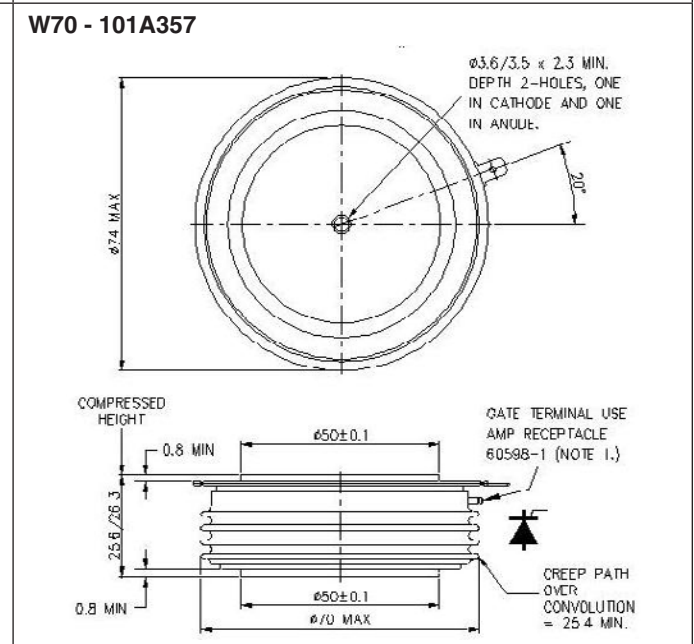
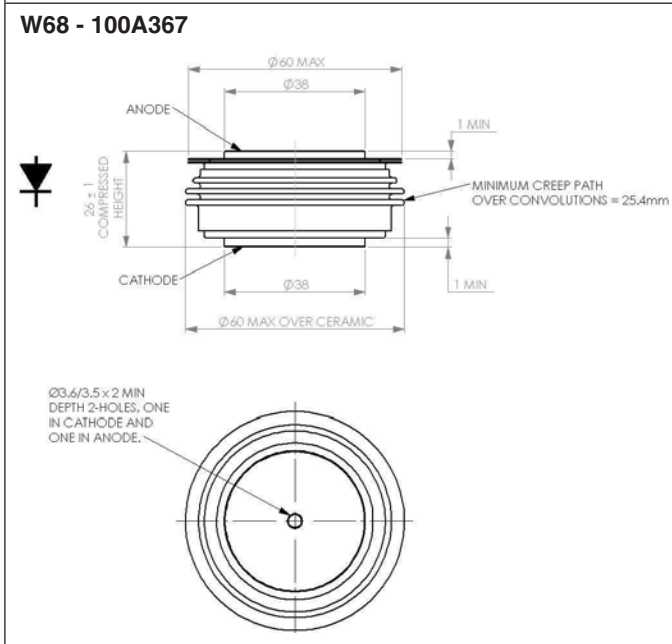
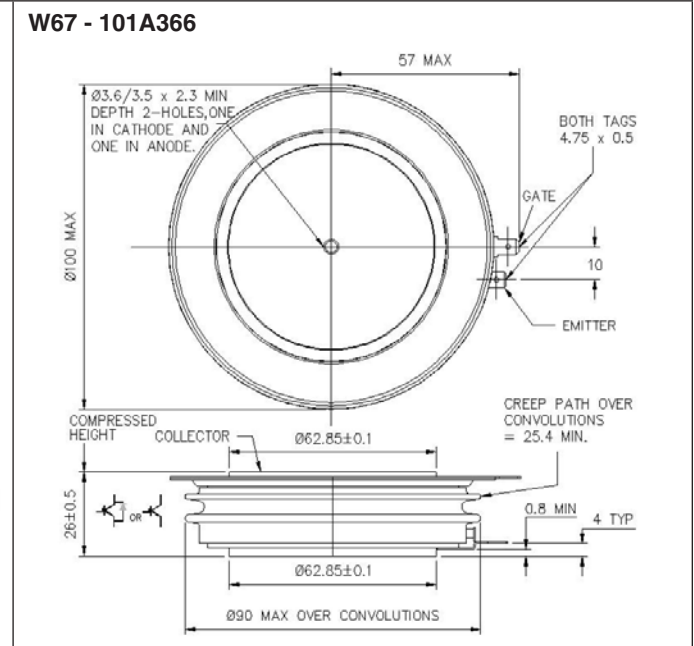
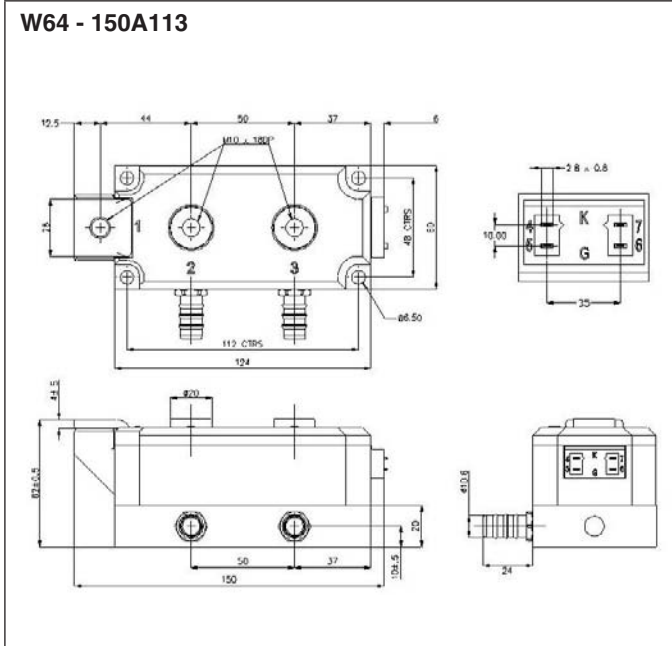
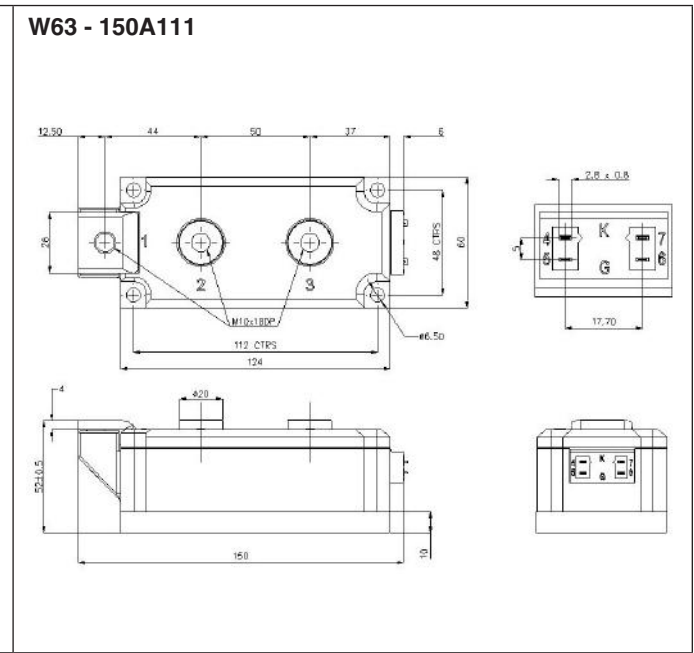
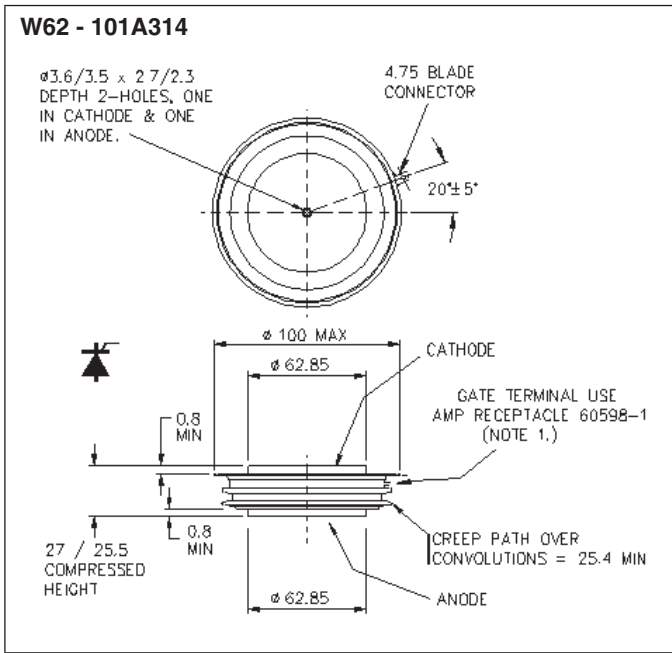

Dimensions in mm and inches (1 mm = 0.0394")

W71 - 101A375

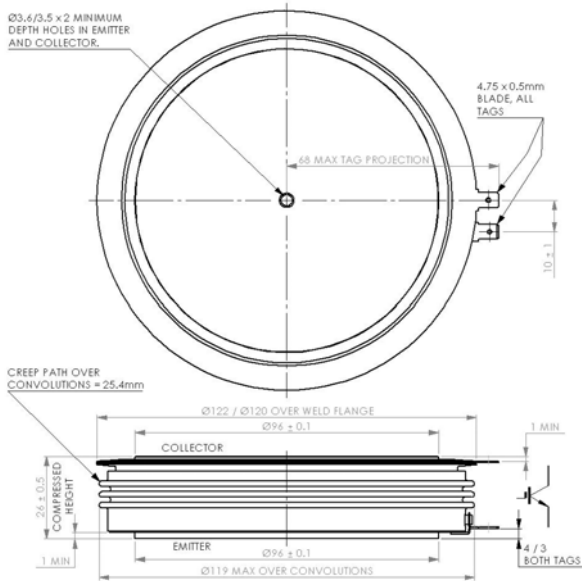

W73 - 150A122

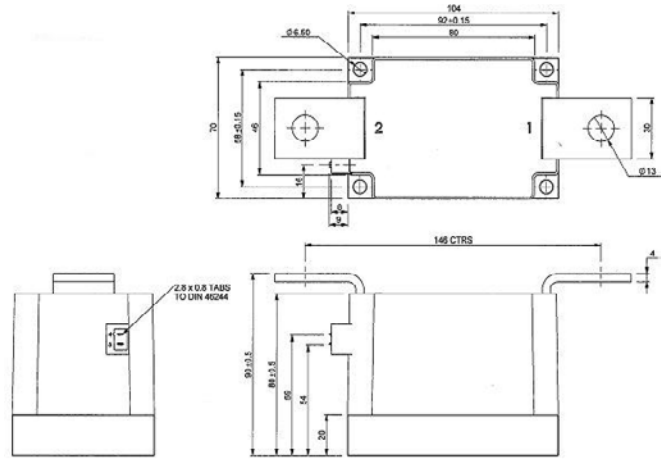

W74 - 150A123

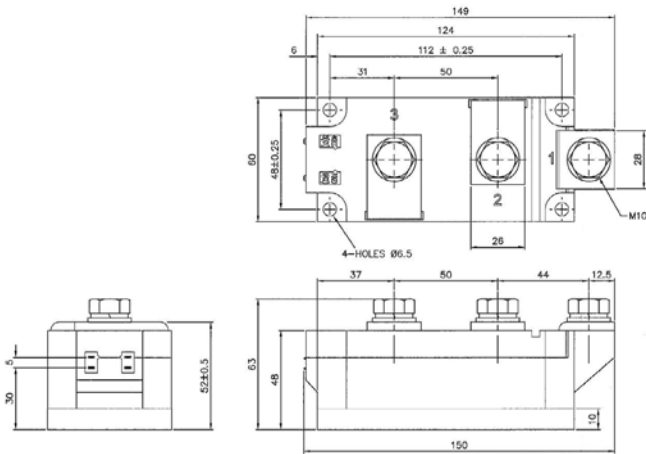

W75 - 101A377

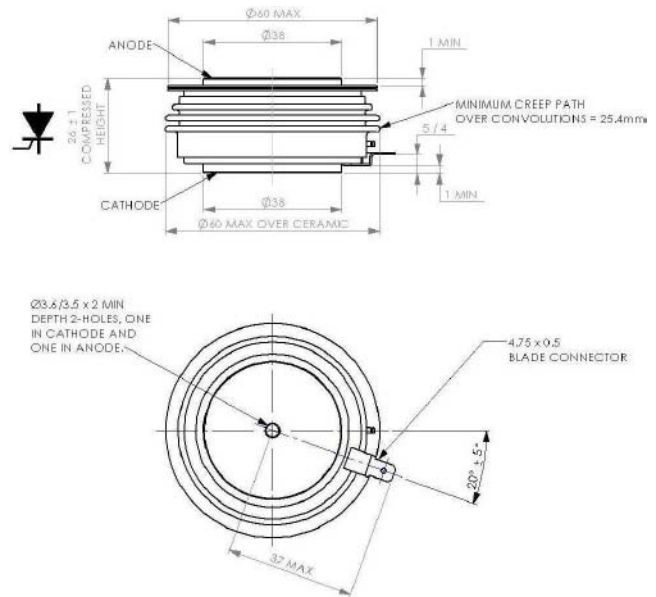

W76 - 101A392

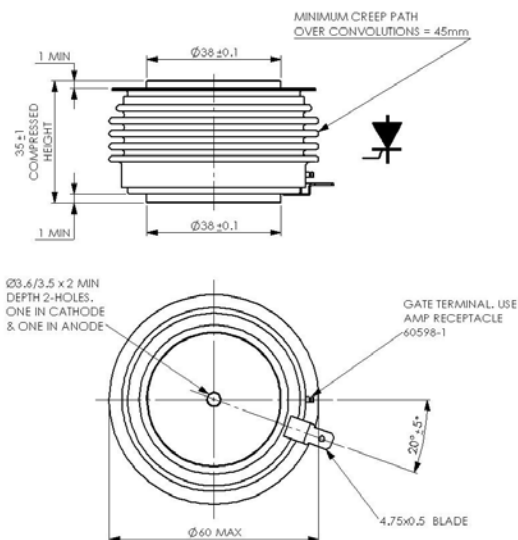

W77 - 101A372

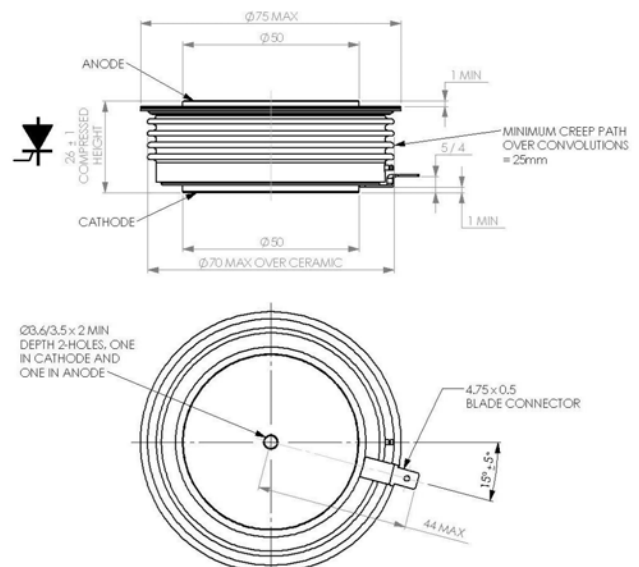

Dimensions in mm and inches (1 mm = 0.0394")

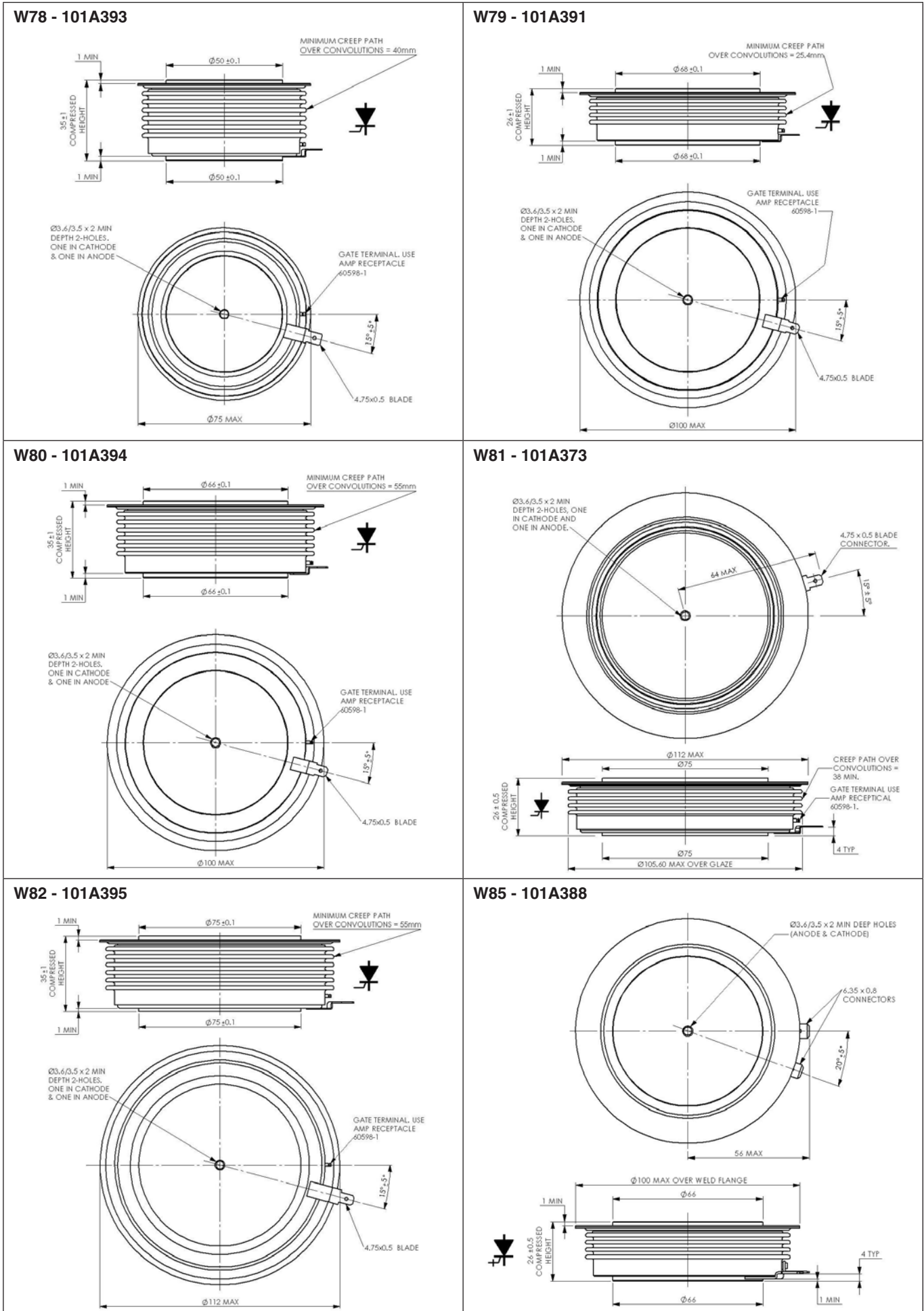

Dimensions in mm and inches (1 mm = 0.0394")

W86 - 101A316

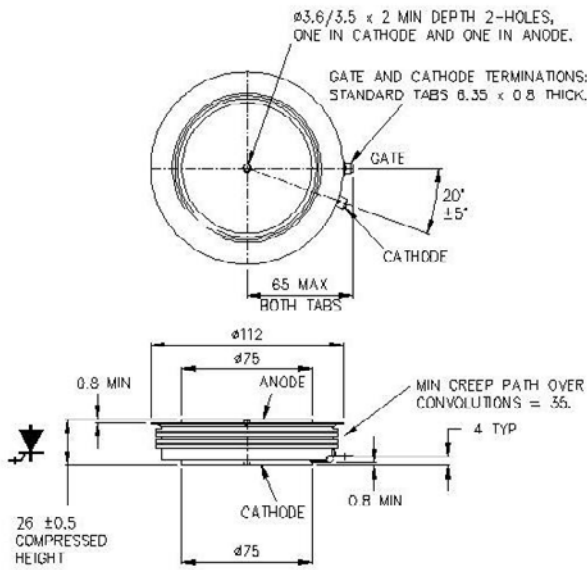

W87 101A376

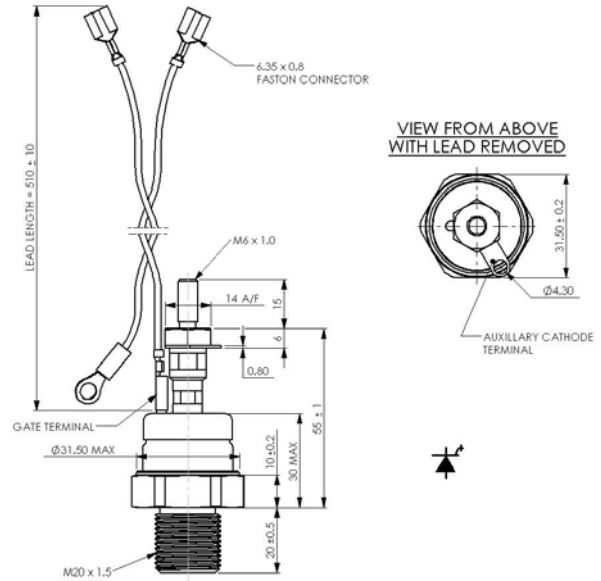

W88 - 150A124

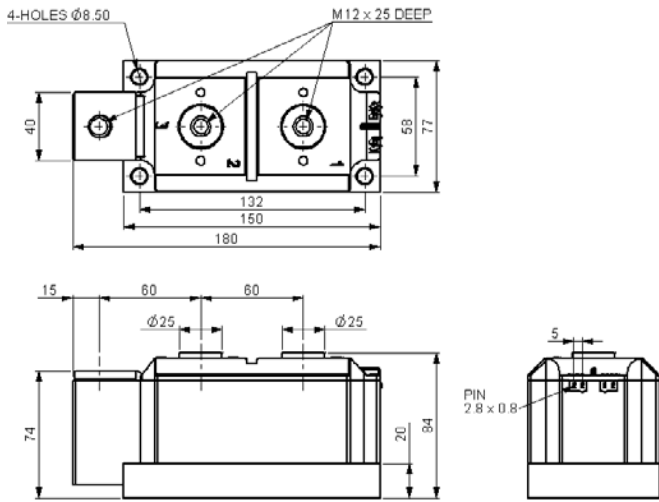

W89 - 100A368

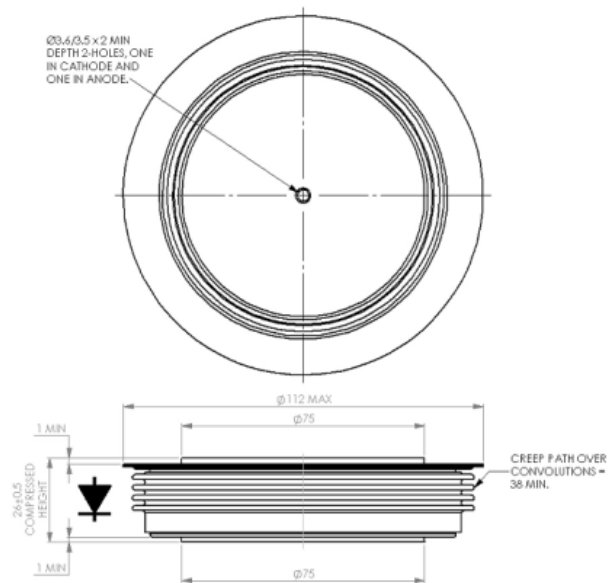

W90 - 101A405

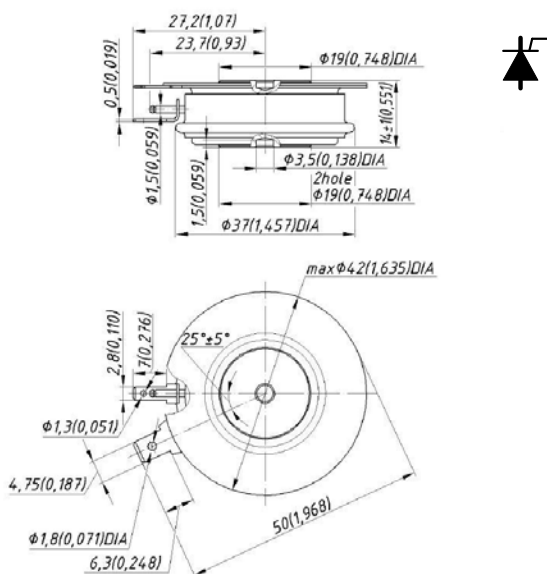

W91 - 101A406

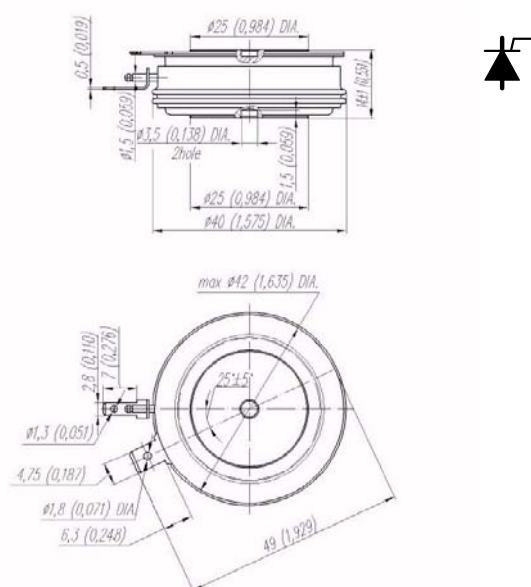

Dimensions in mm and inches (1 mm = 0.0394")

W92 - 101A407

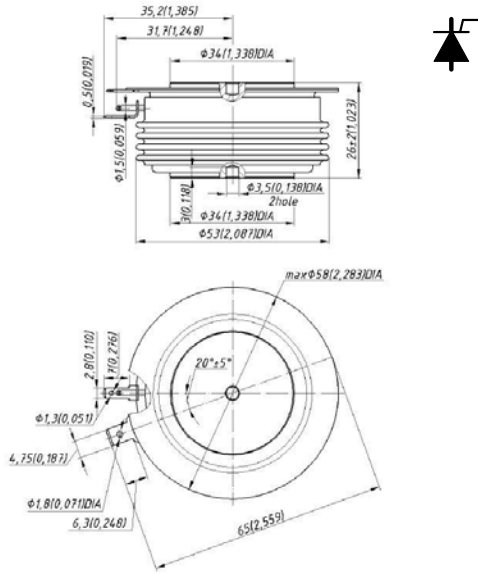

W93 - 101A404

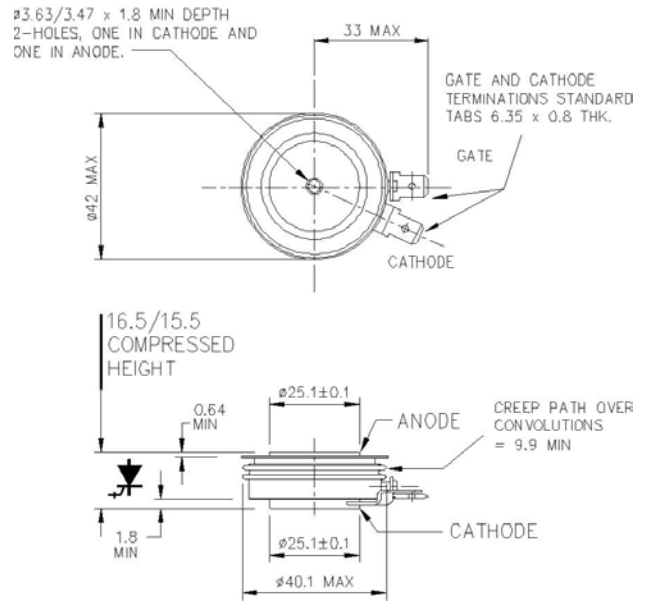

W94 - 100A372

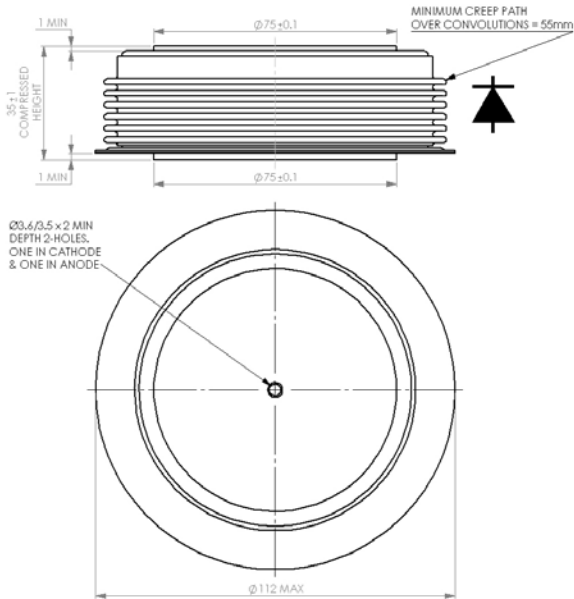

W95 - 101A403

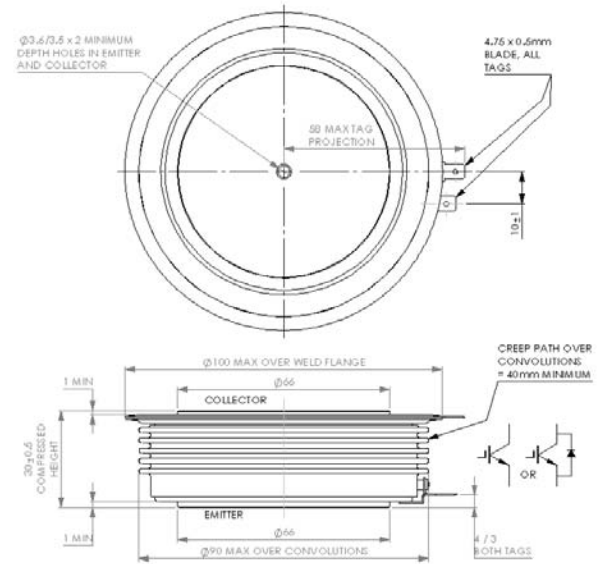

W96 - 101A409

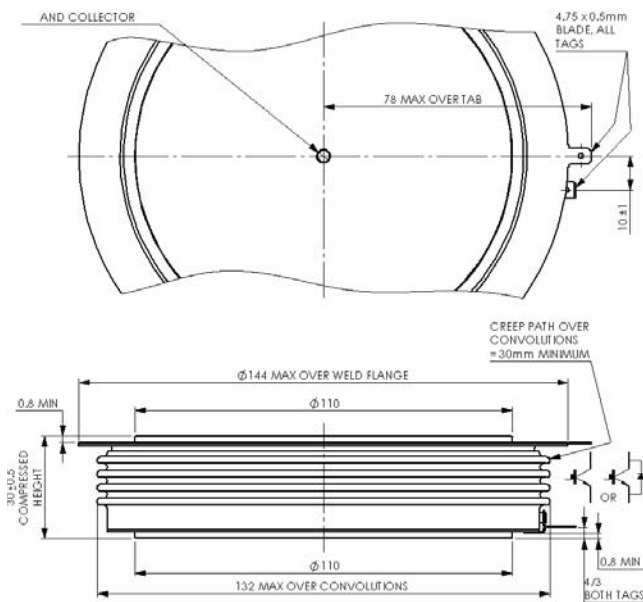

W97 - 100A379

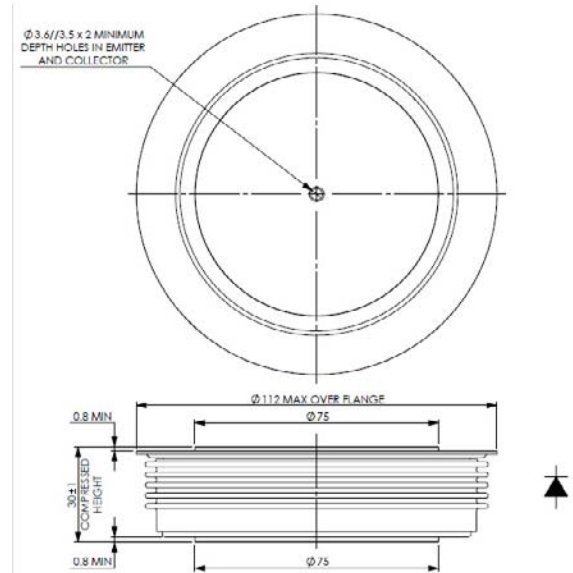

Dimensions in mm and inches (1 mm = 0.0394")

W98 - 101A413

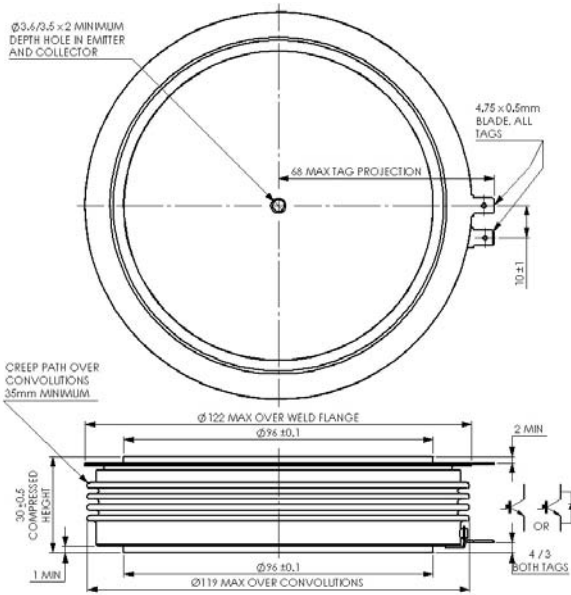

W99 - 100A383

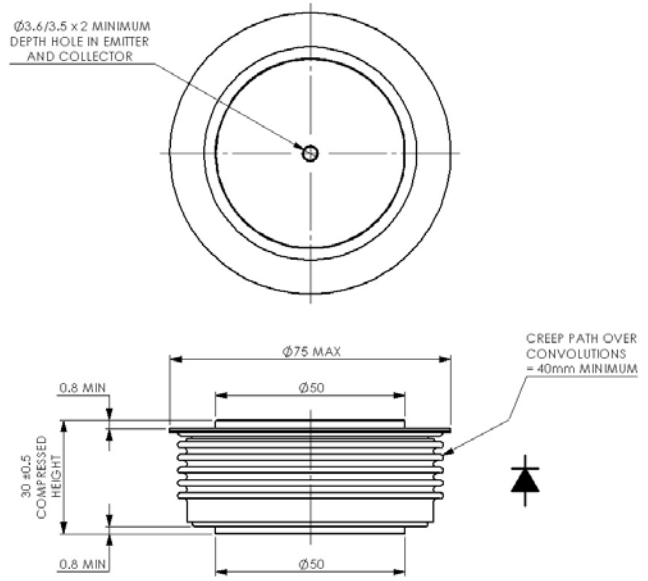

W100 - 100A384

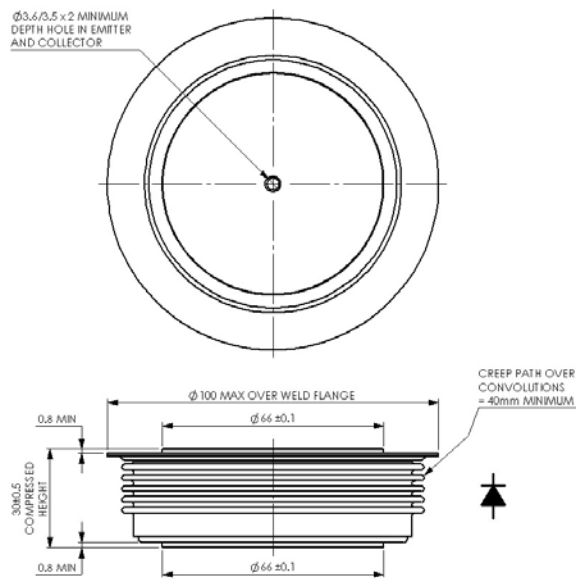

W101 - 100A380

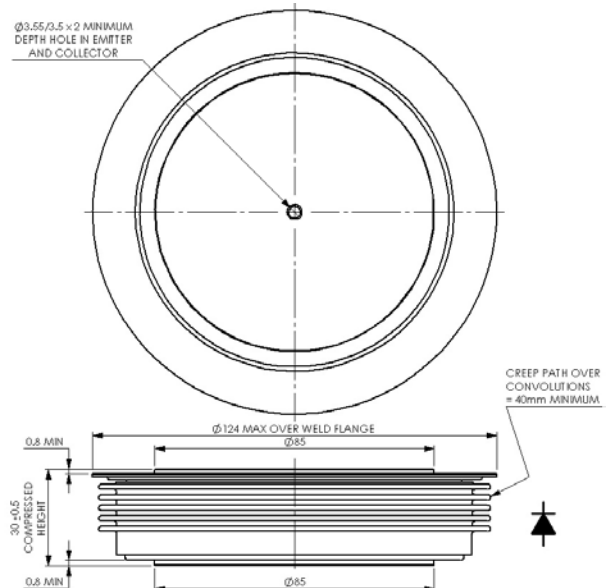

W102 - 150A125

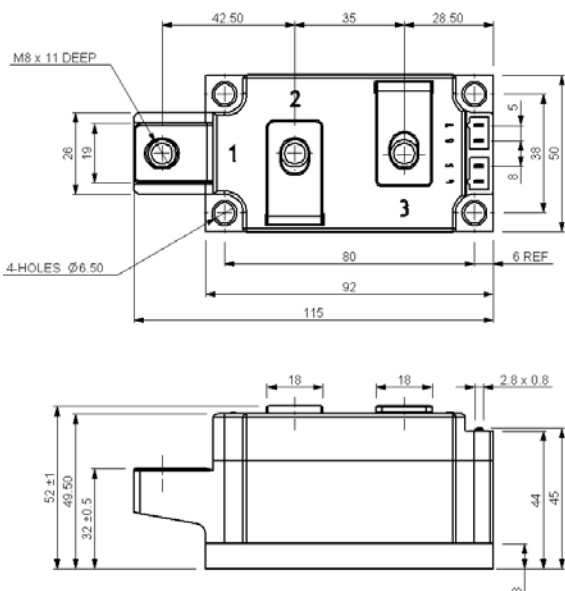

W103 - 101A401

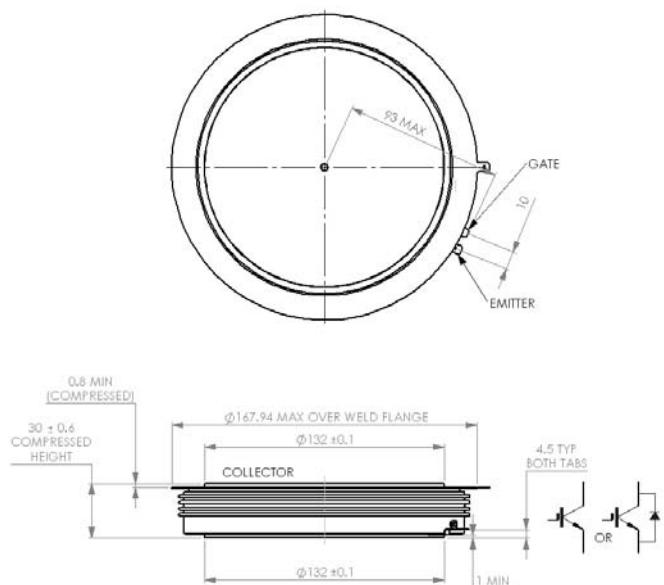

Dimensions in mm and inches (1 mm = 0.0394")

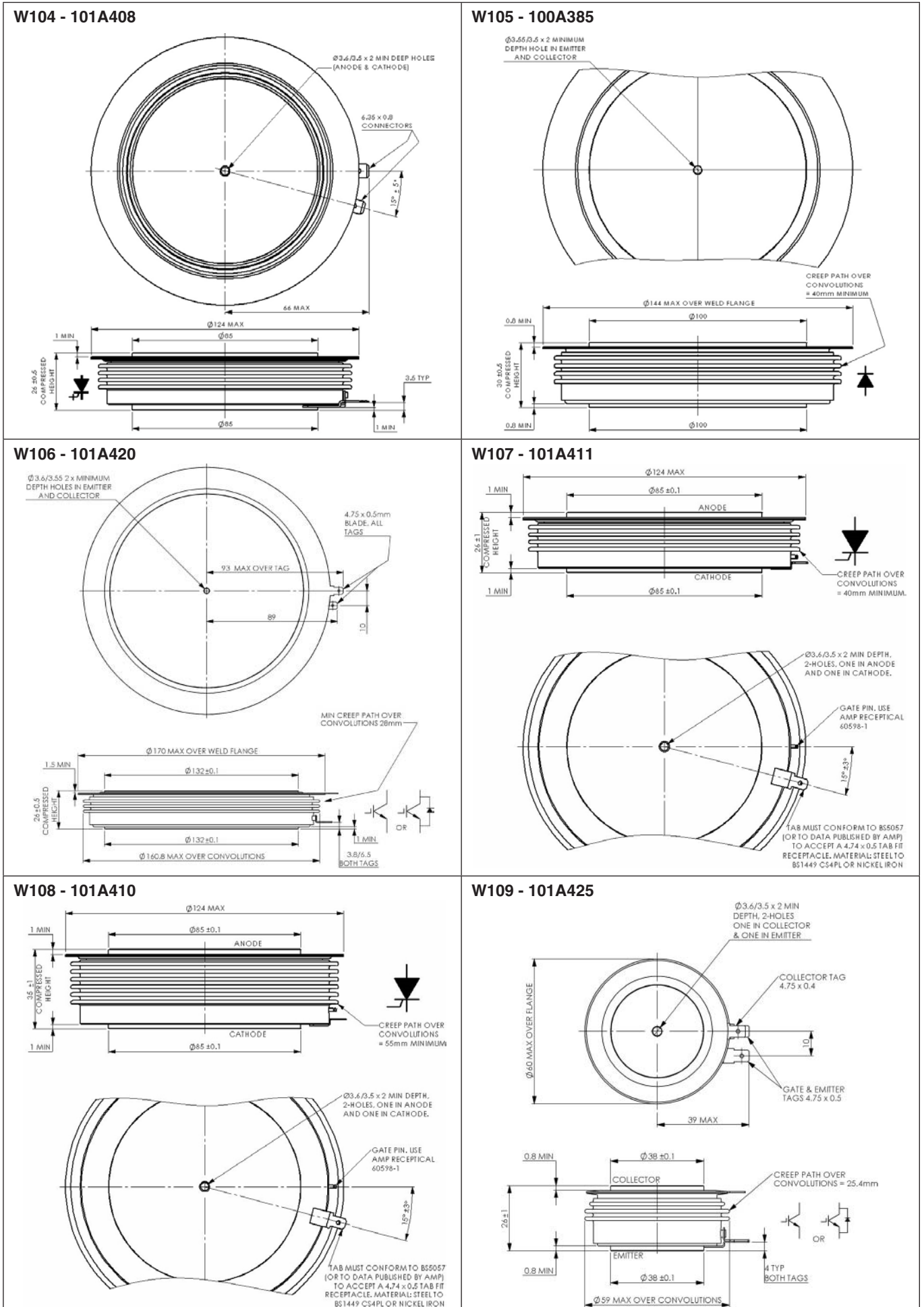

Dimensions in mm and inches (1 mm = 0.0394")

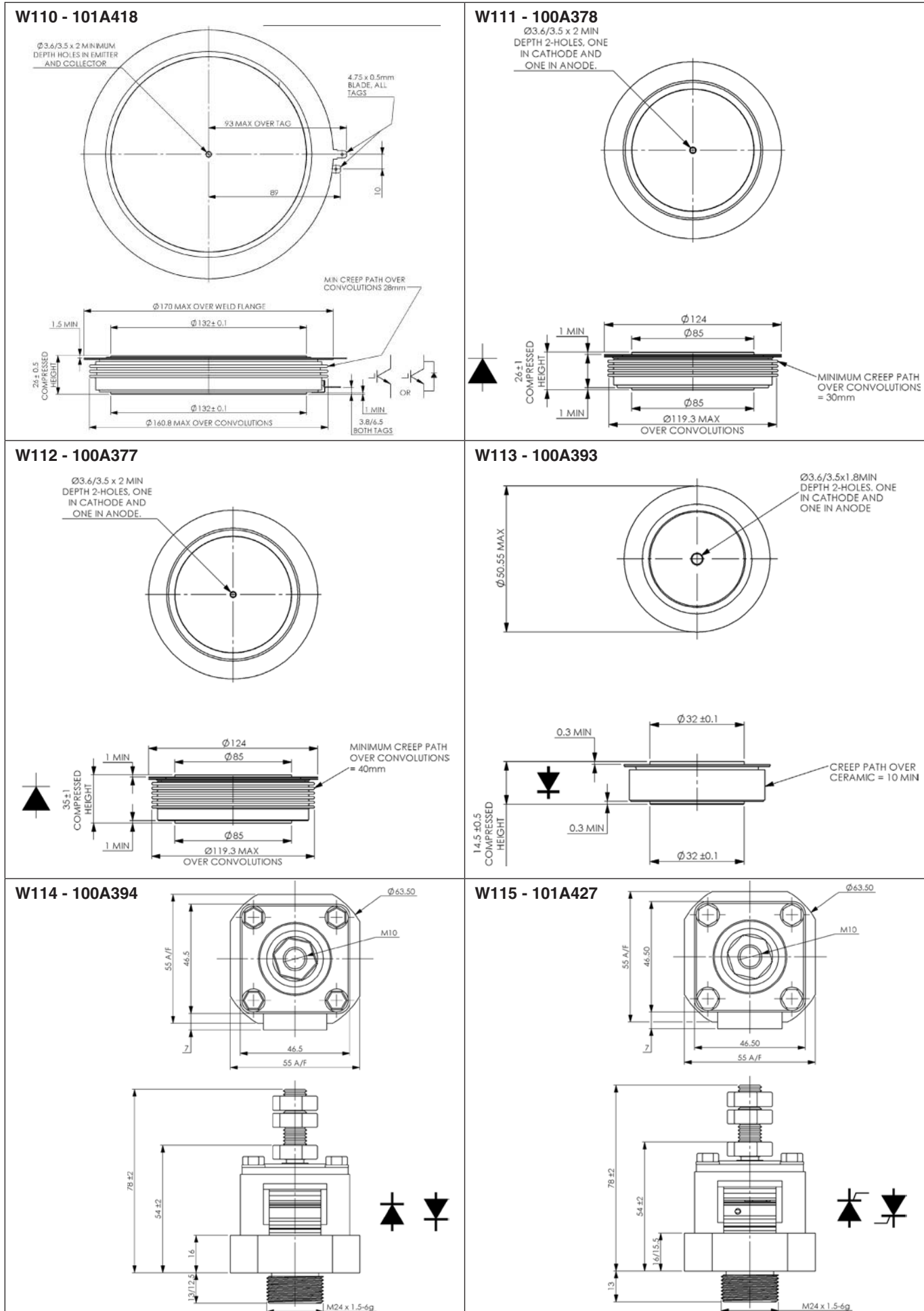

Dimensions in mm and inches (1 mm = 0.0394")

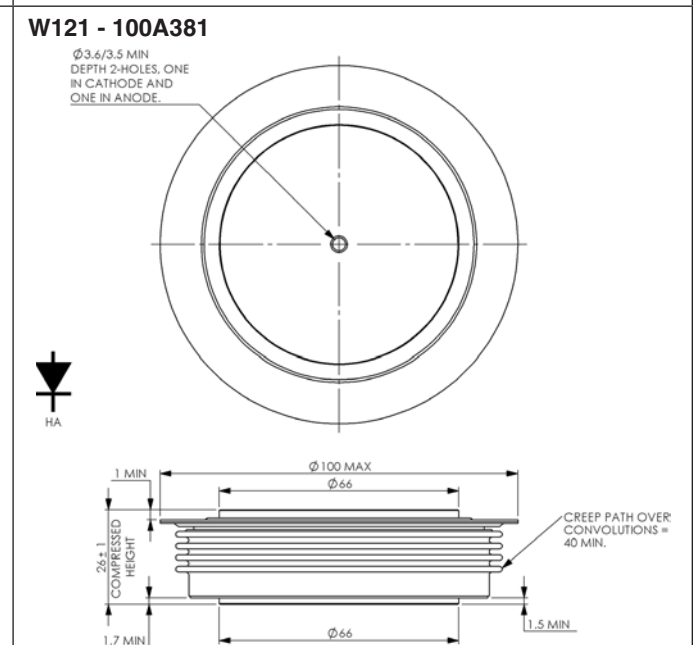
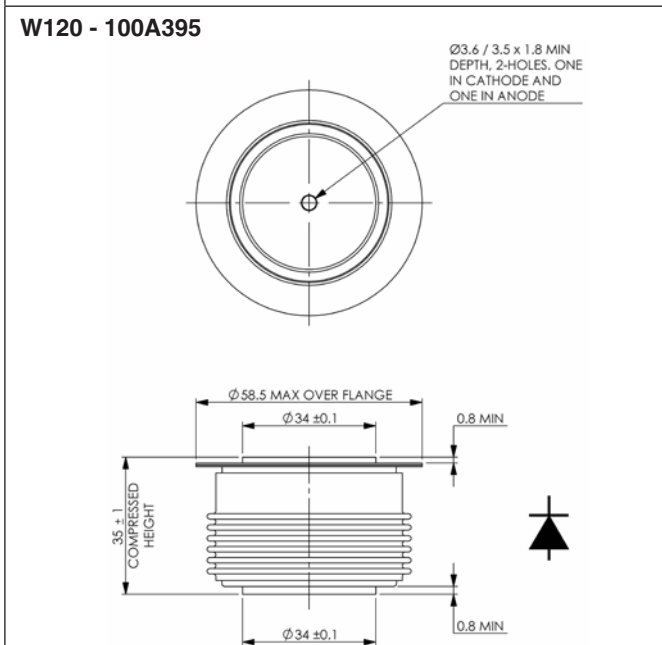
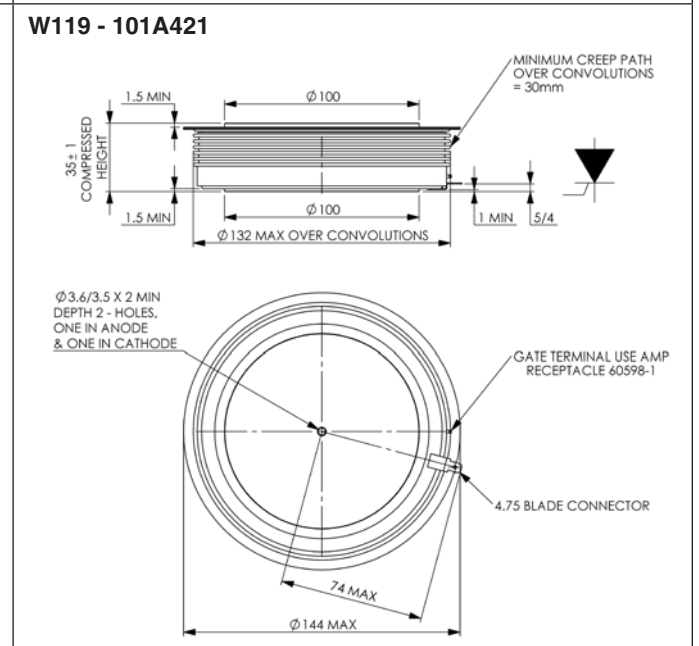
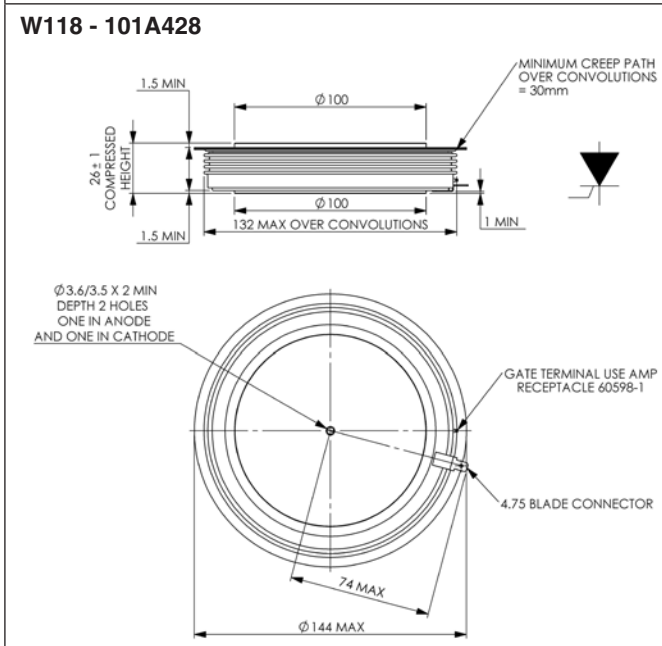
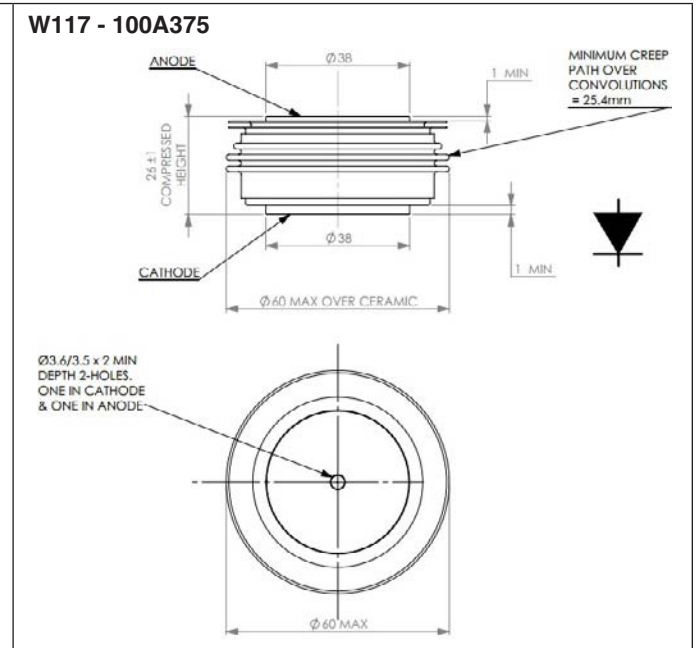
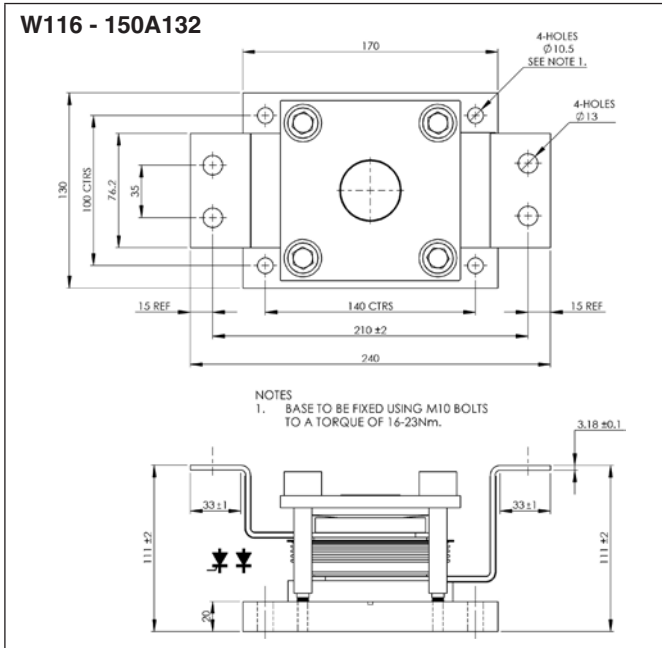

Dimensions in mm and inches (1 mm = 0.0394")

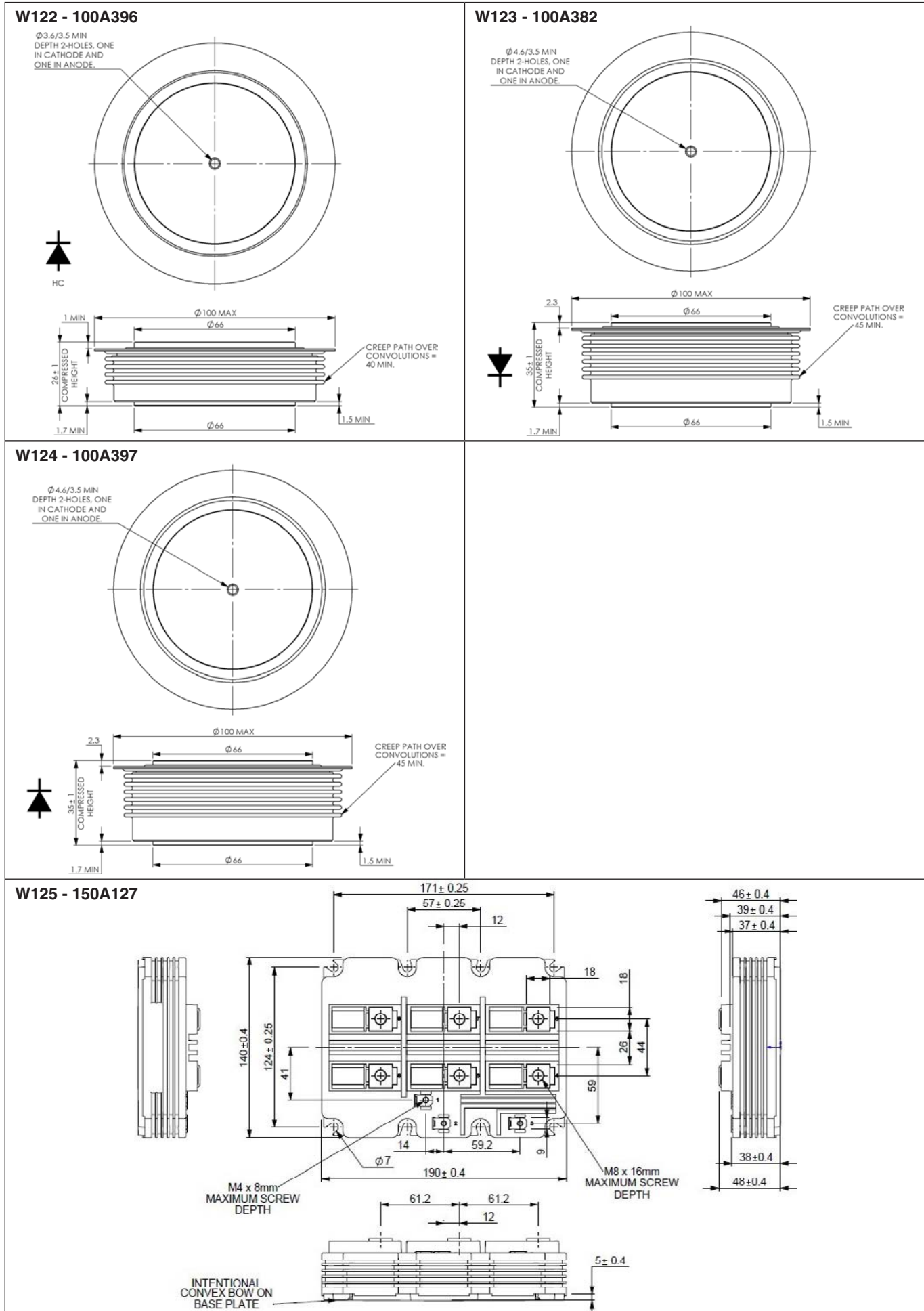

Dimensions in mm and inches (1 mm = 0.0394")

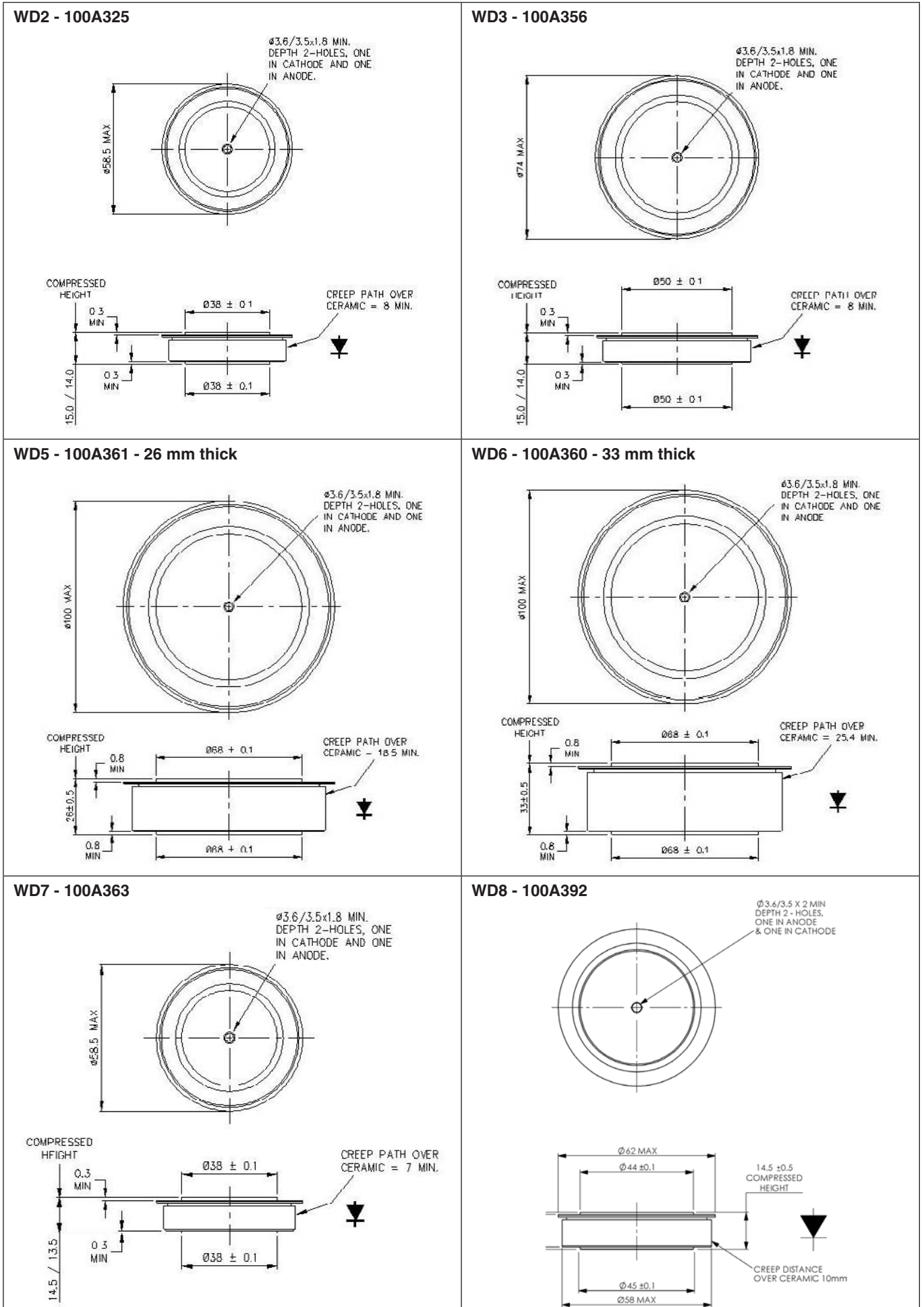

Dimensions in mm and inches (1 mm = 0.0394")

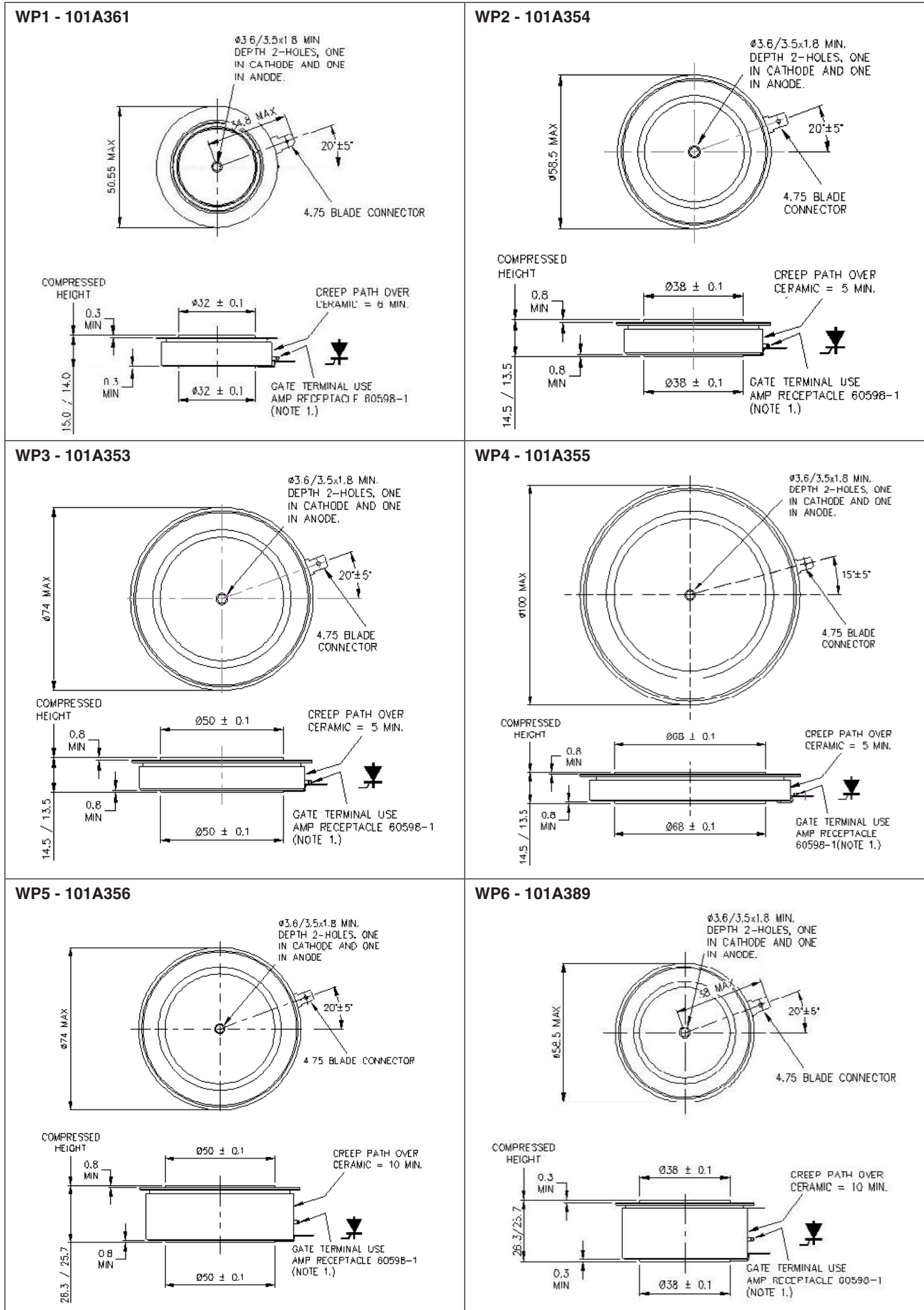

Dimensions in mm and inches (1 mm = 0.0394")

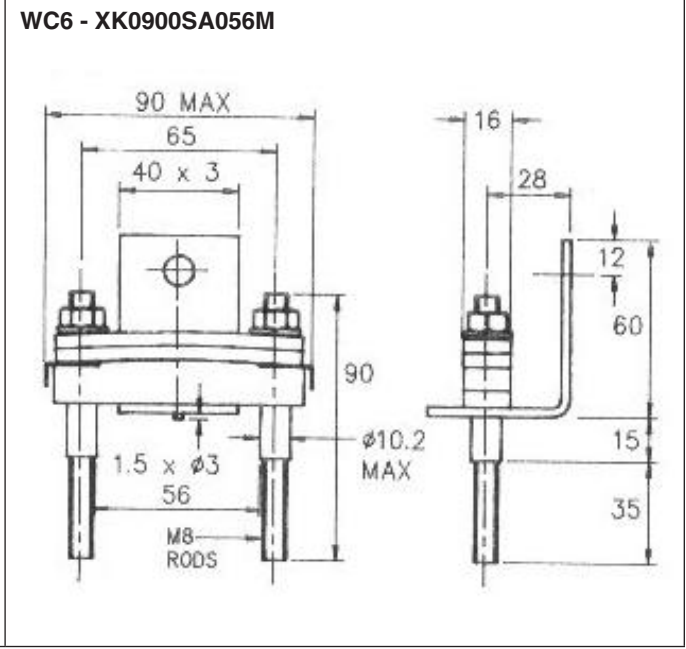
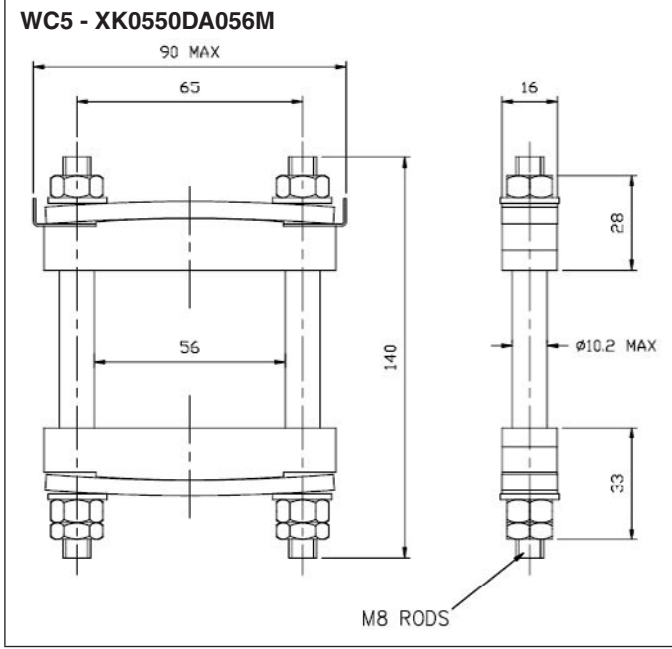
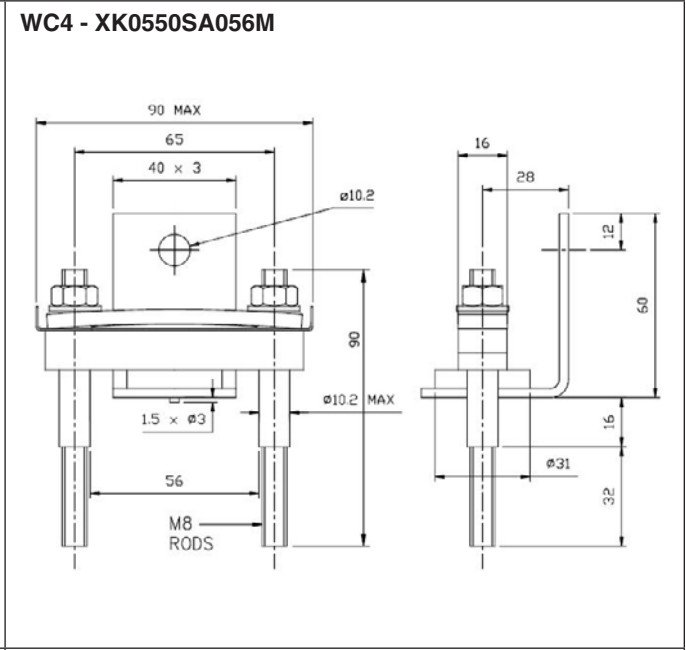
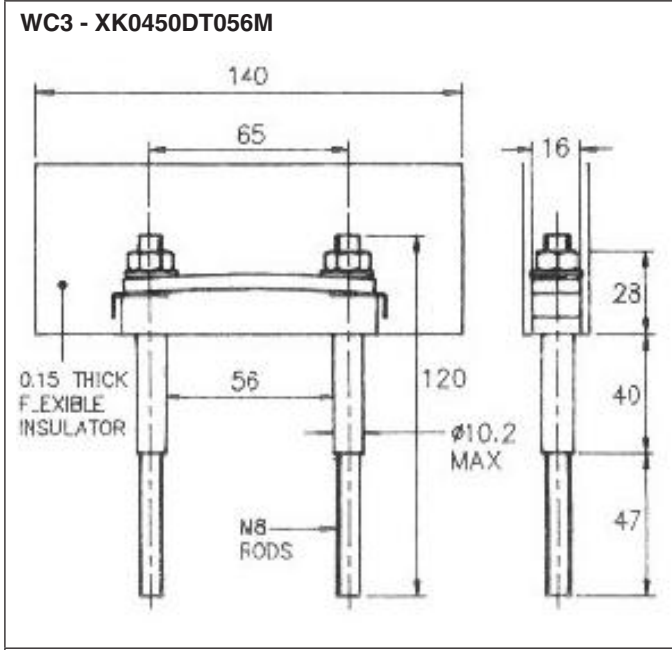
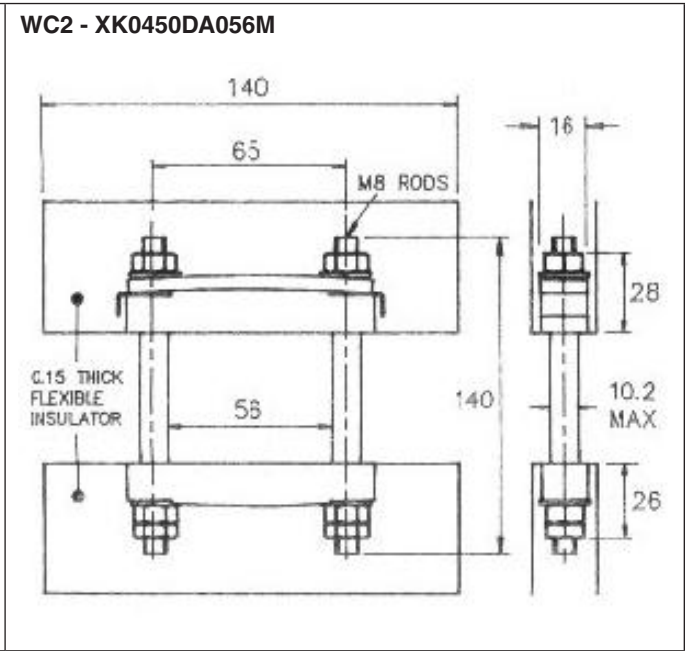
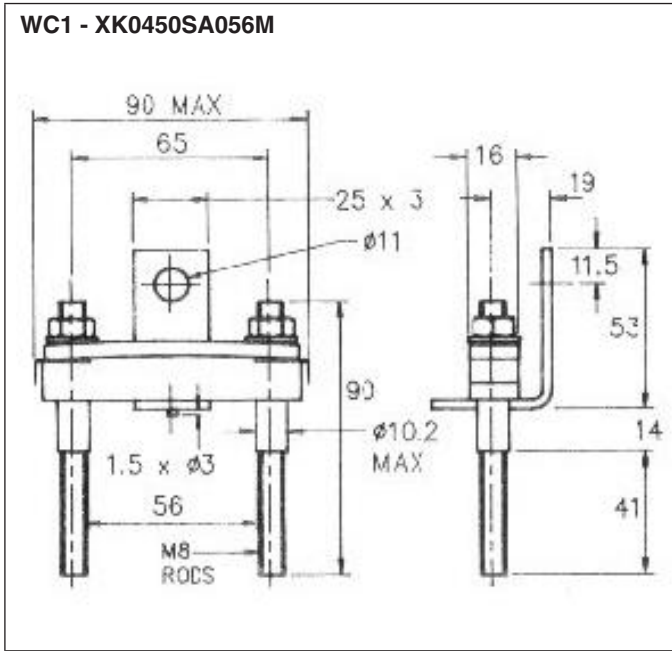

Dimensions in mm and inches (1 mm = 0.0394")

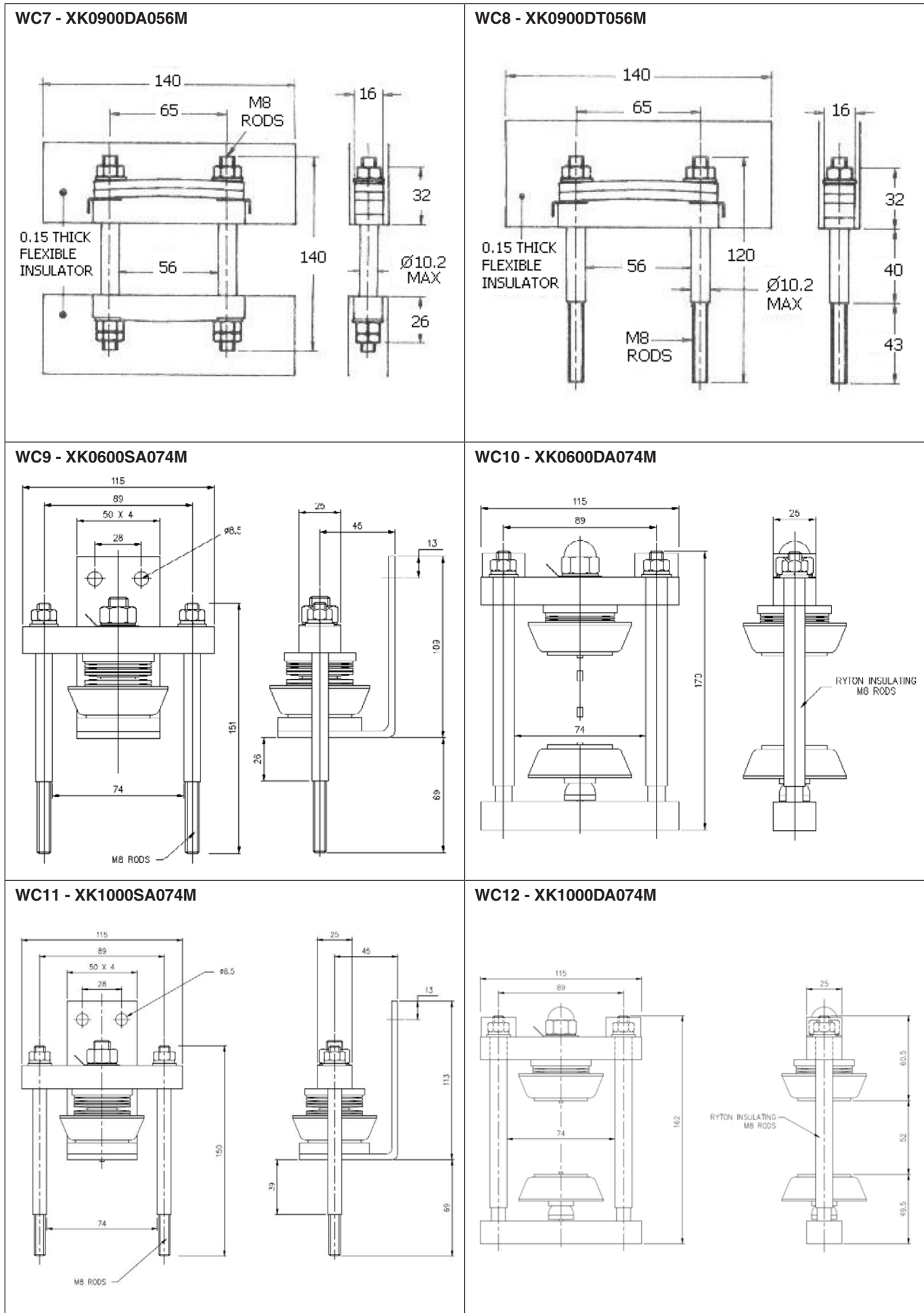

Dimensions in mm and inches (1 mm = 0.0394")

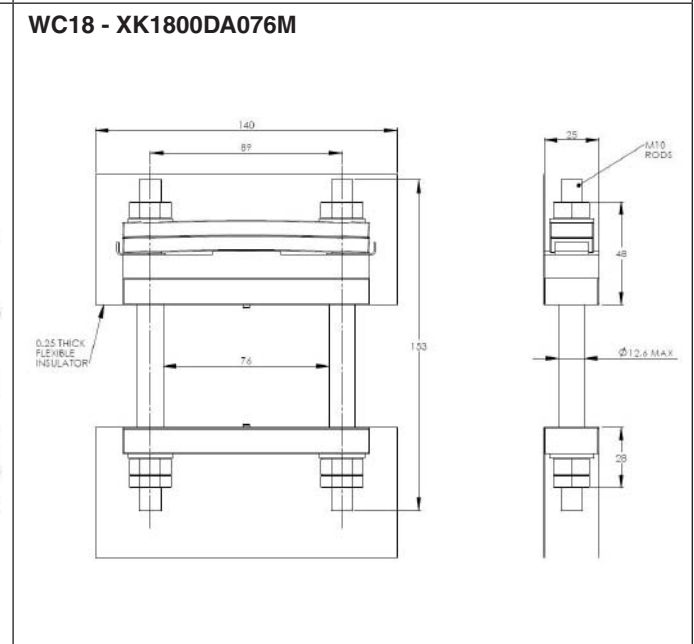
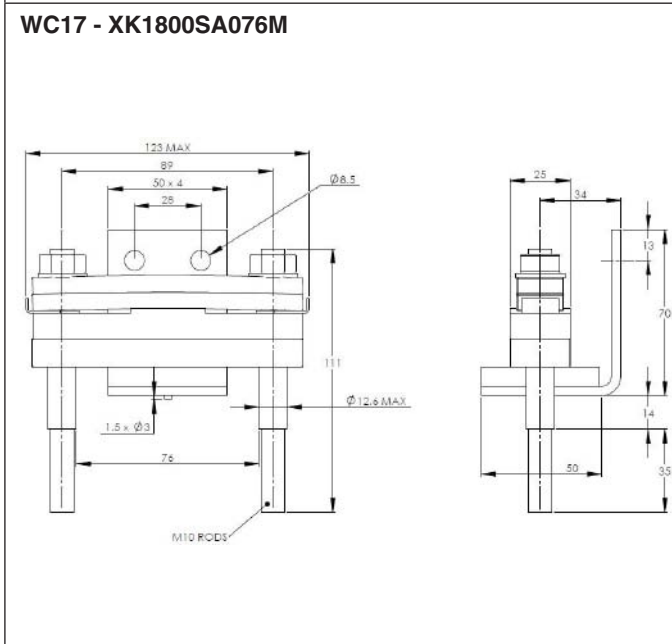
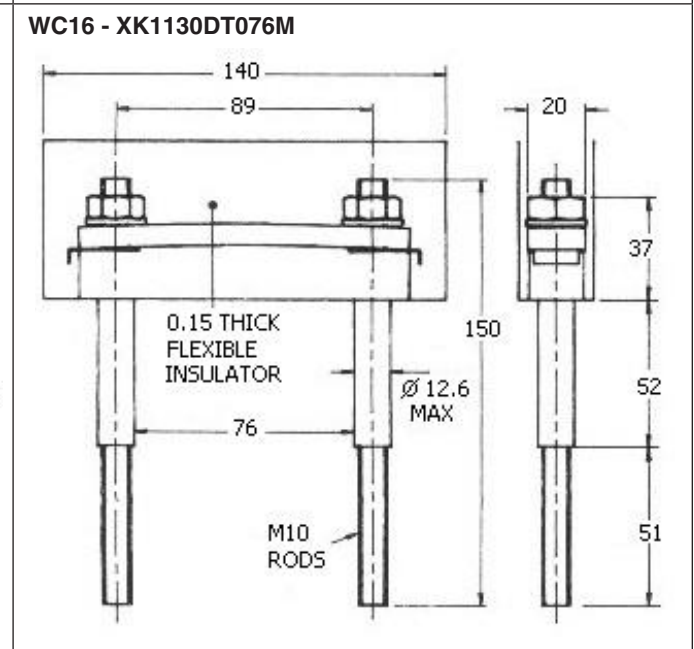
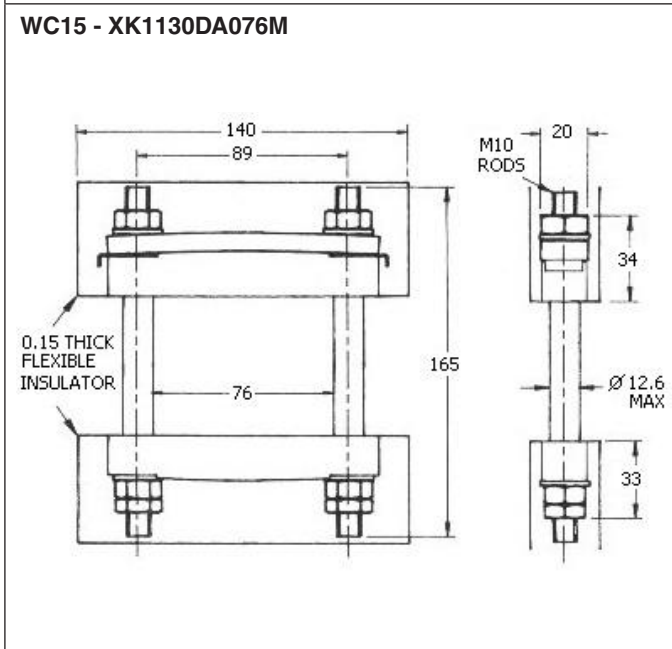
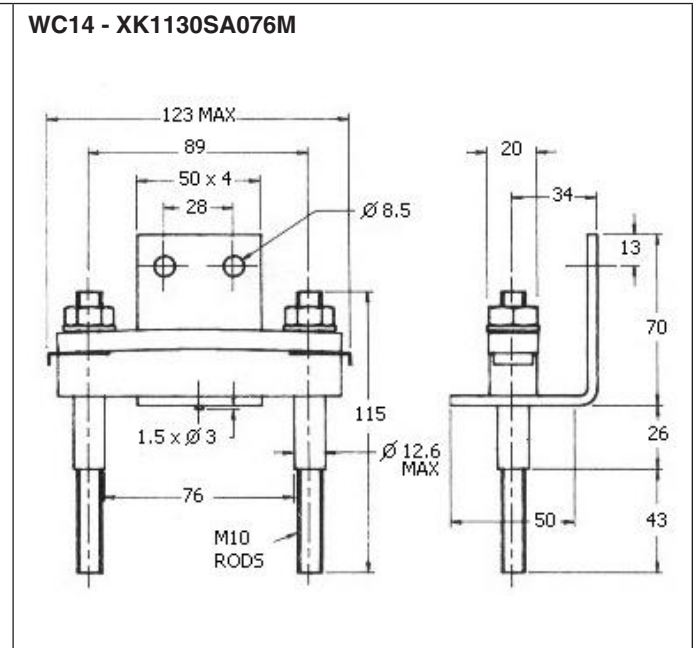
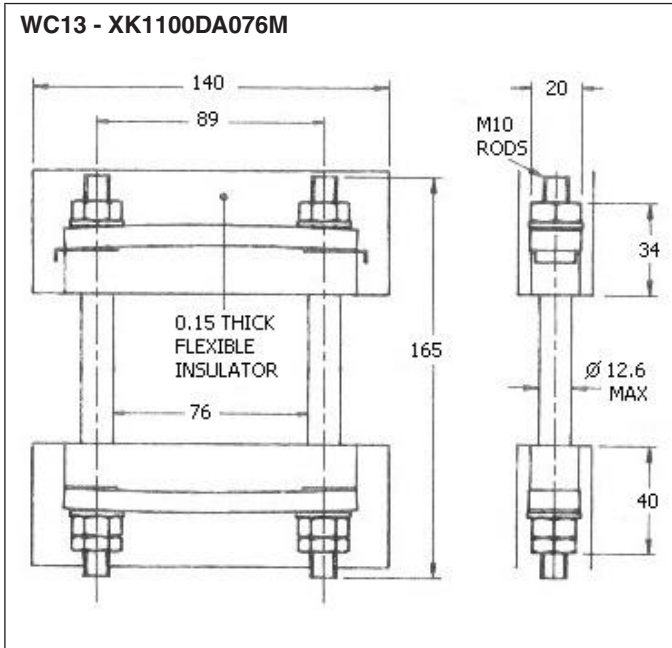

Dimensions in mm and inches (1 mm = 0.0394")

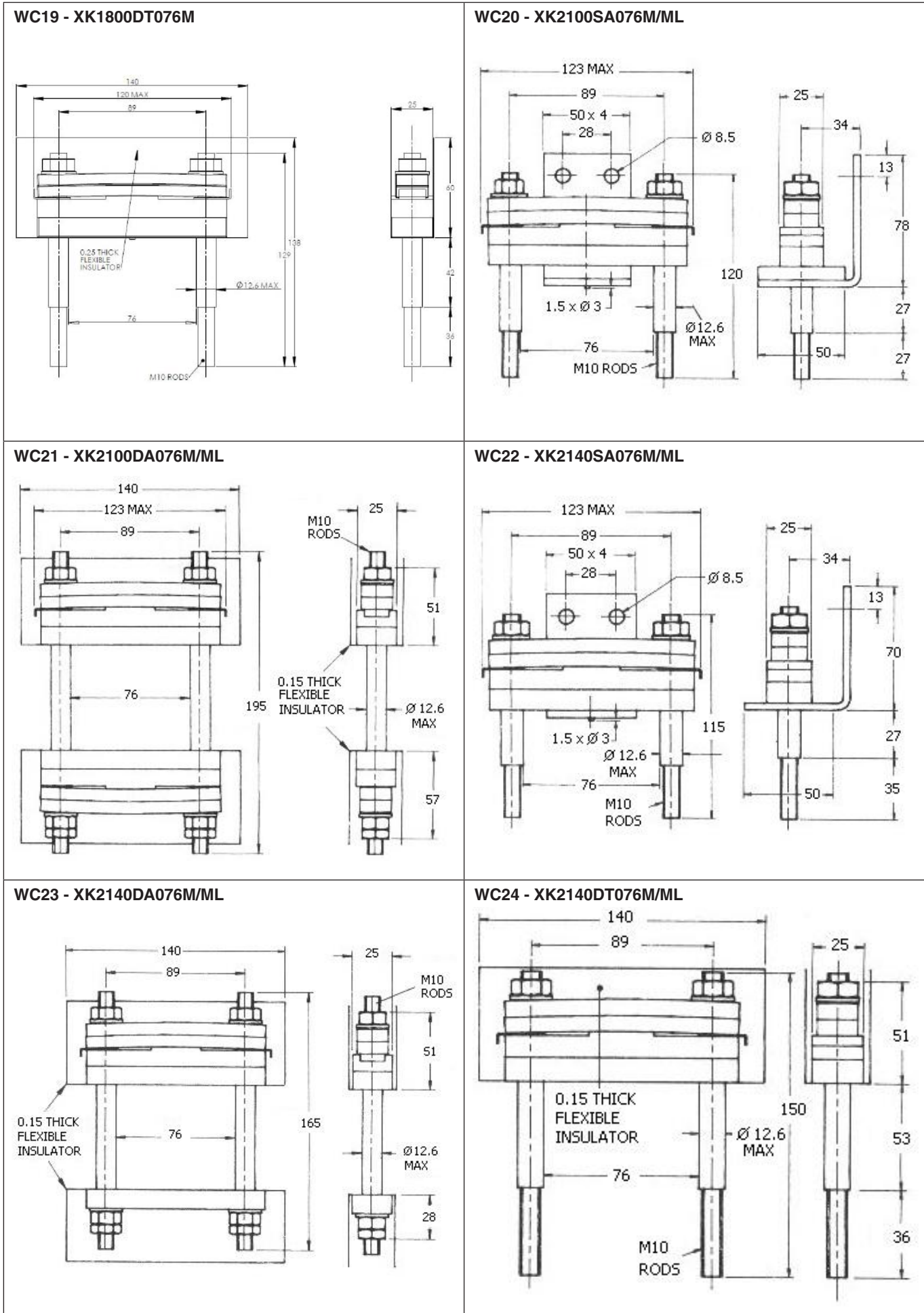

Dimensions in mm and inches (1 mm = 0.0394")

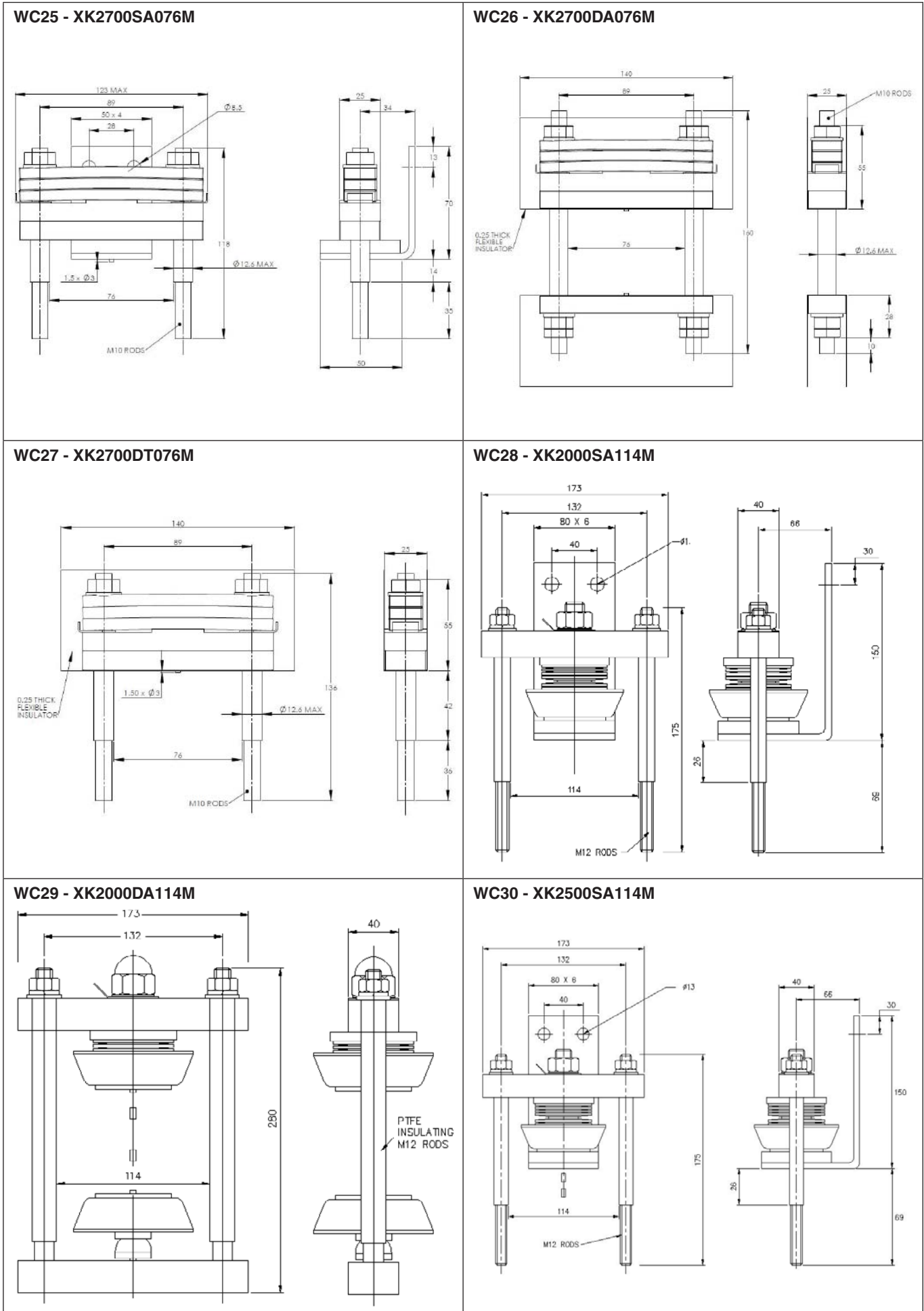

Dimensions in mm and inches (1 mm = 0.0394")

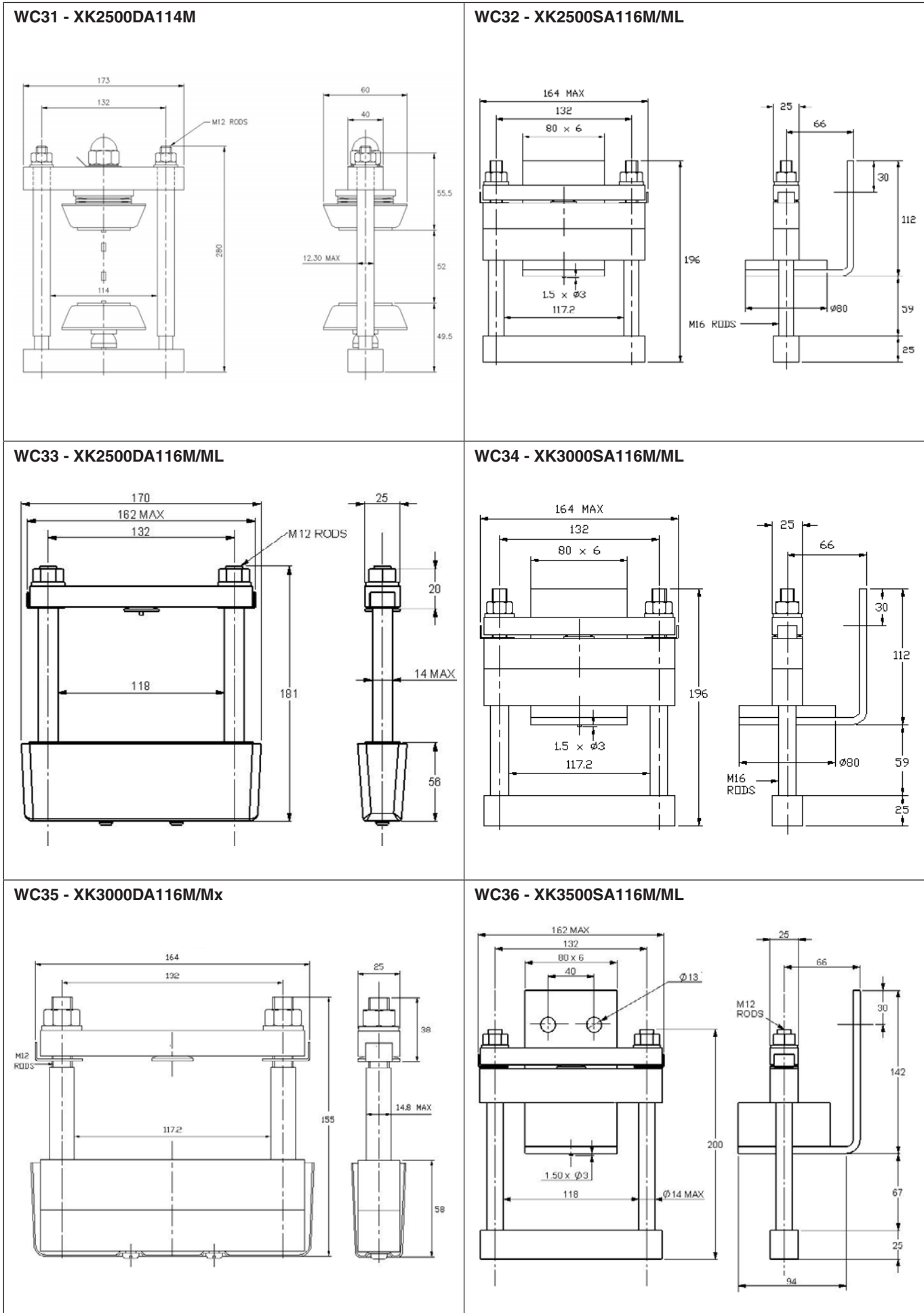

Dimensions in mm and inches (1 mm = 0.0394")

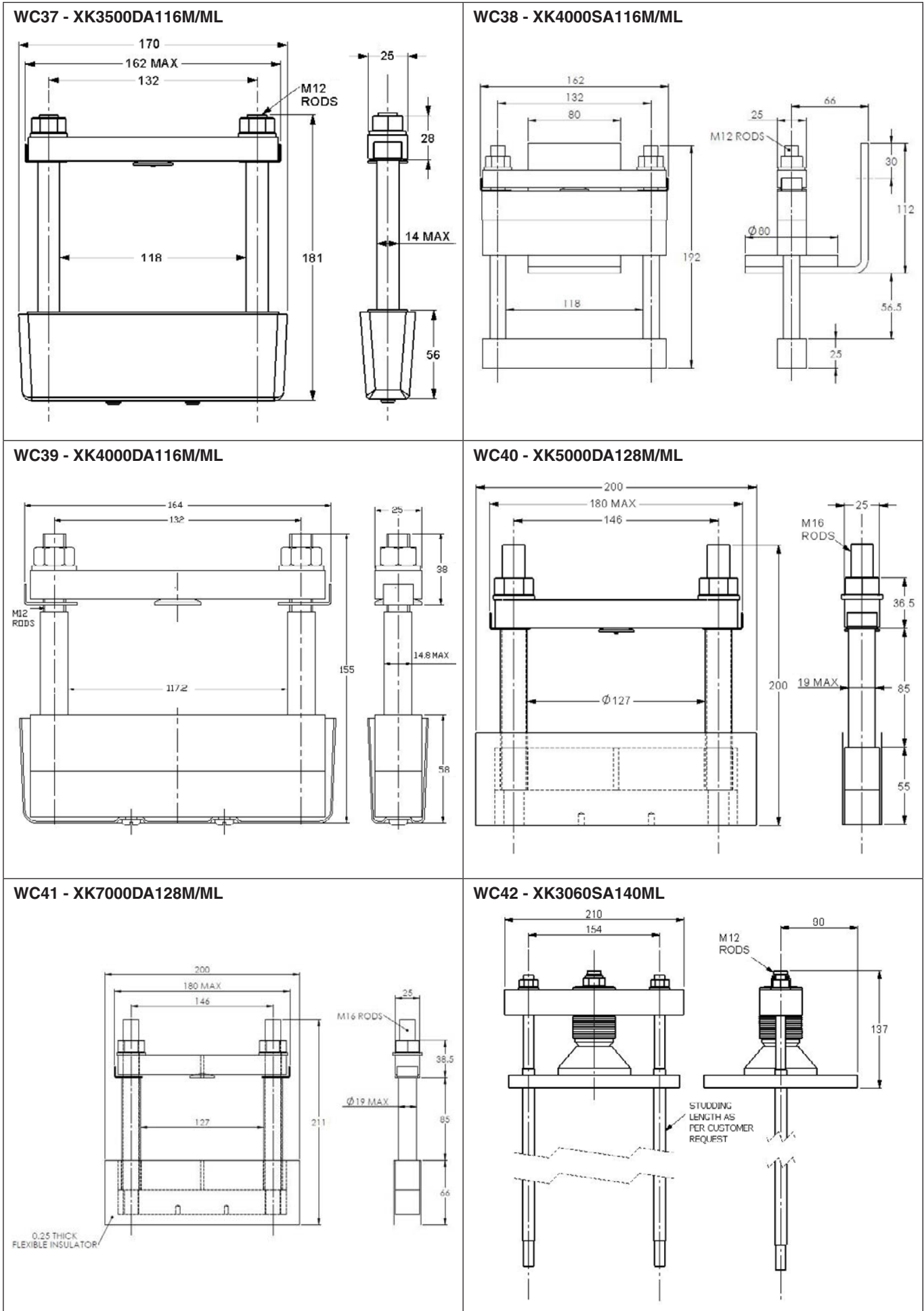

Dimensions in mm and inches (1 mm = 0.0394")

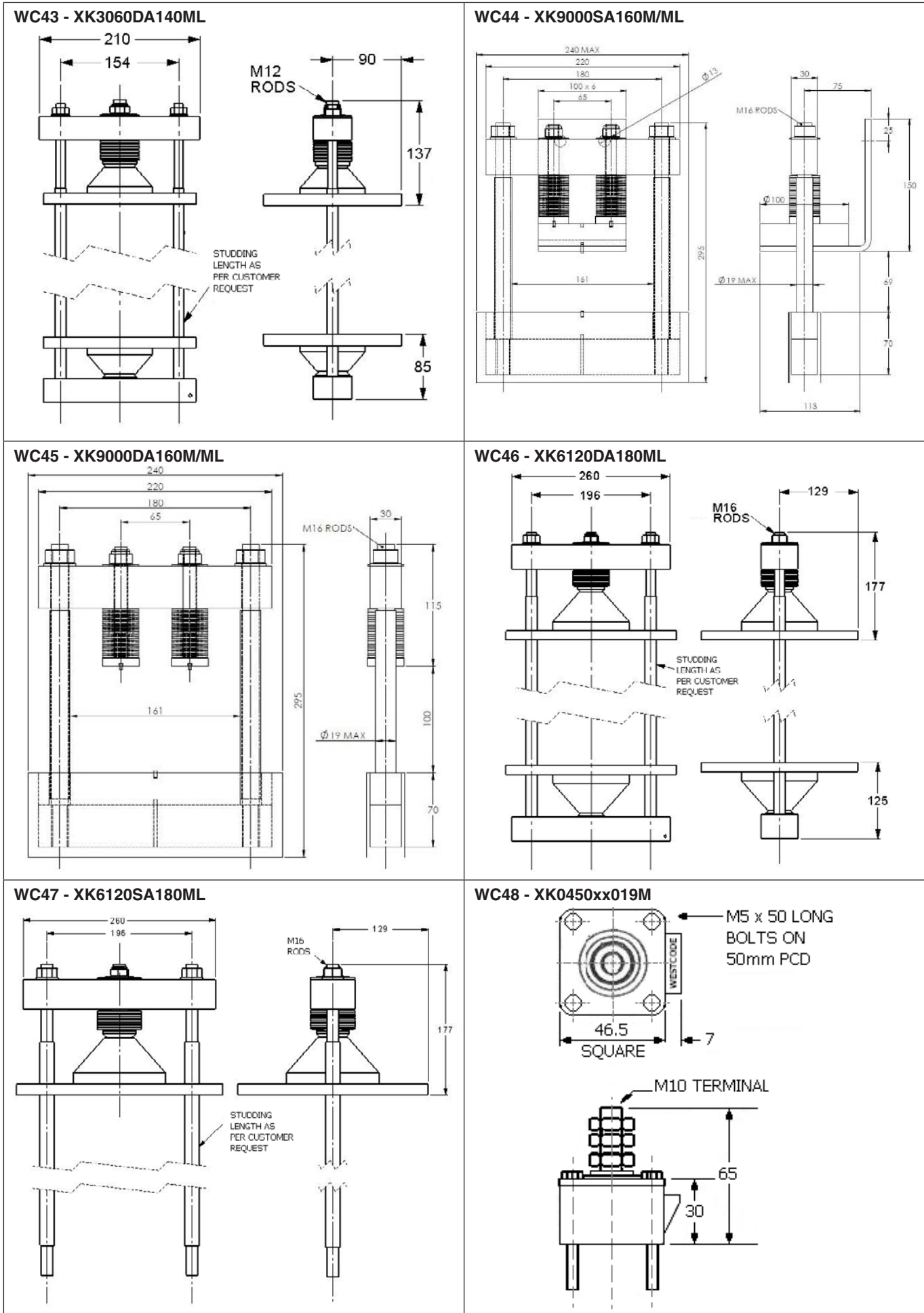

Dimensions in mm and inches (1 mm = 0.0394")

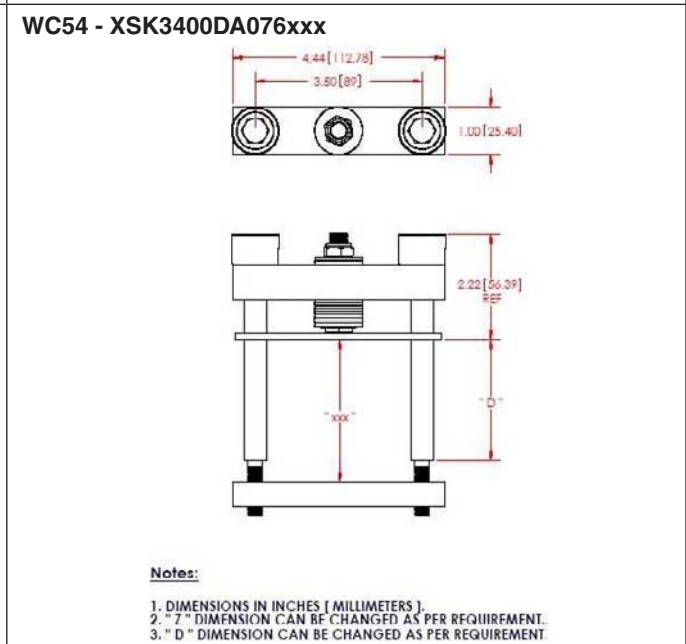
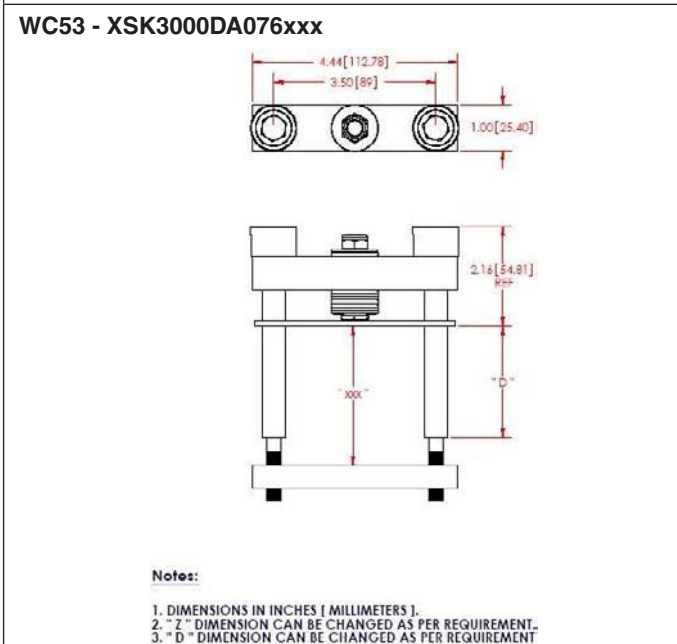
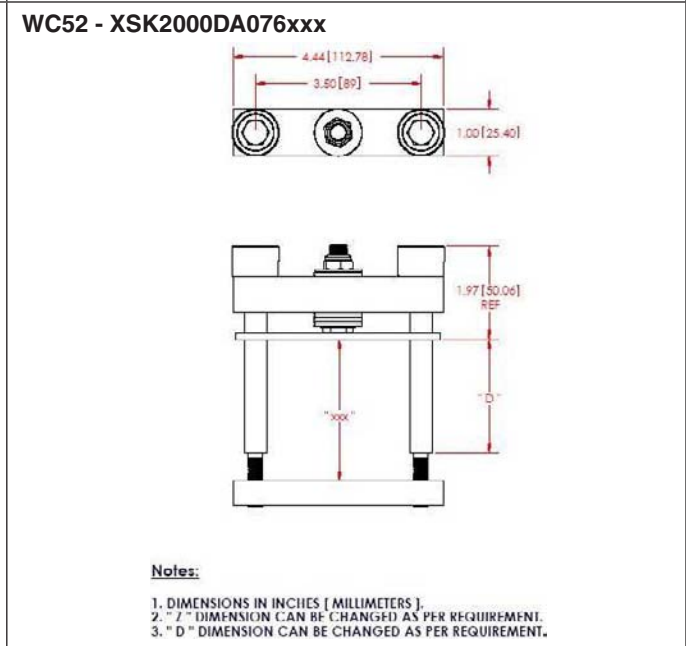
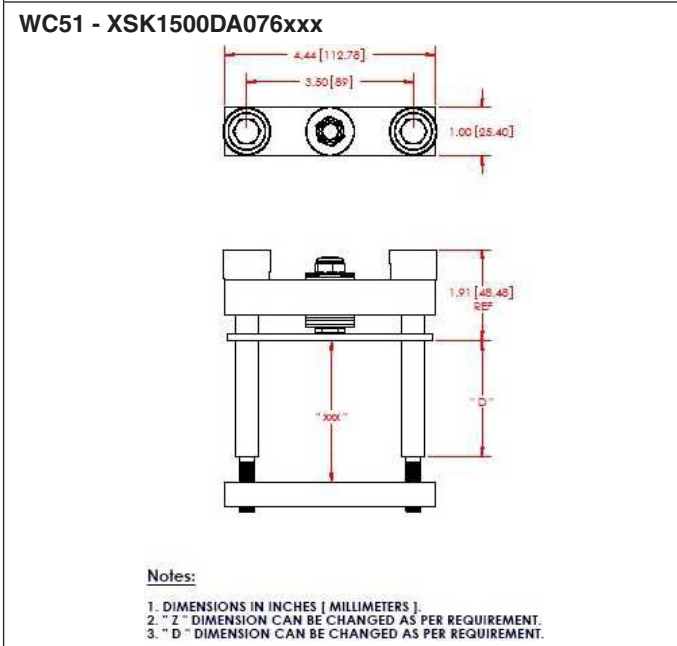
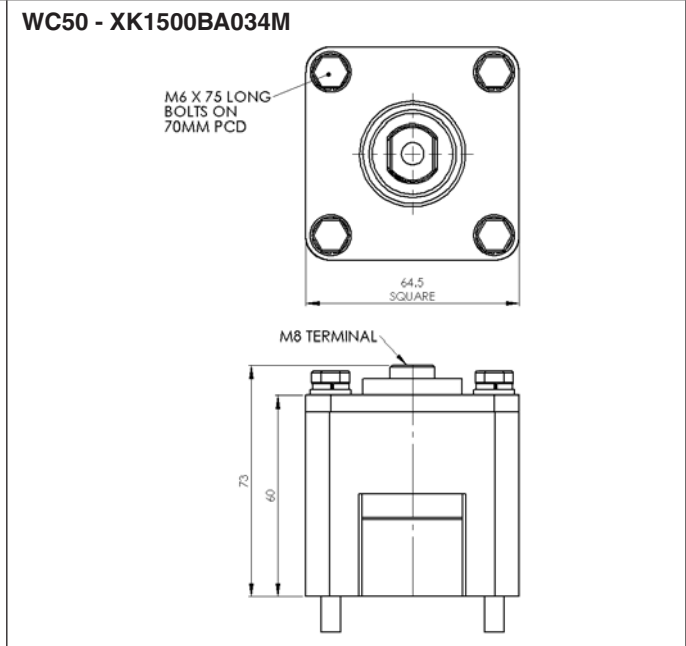
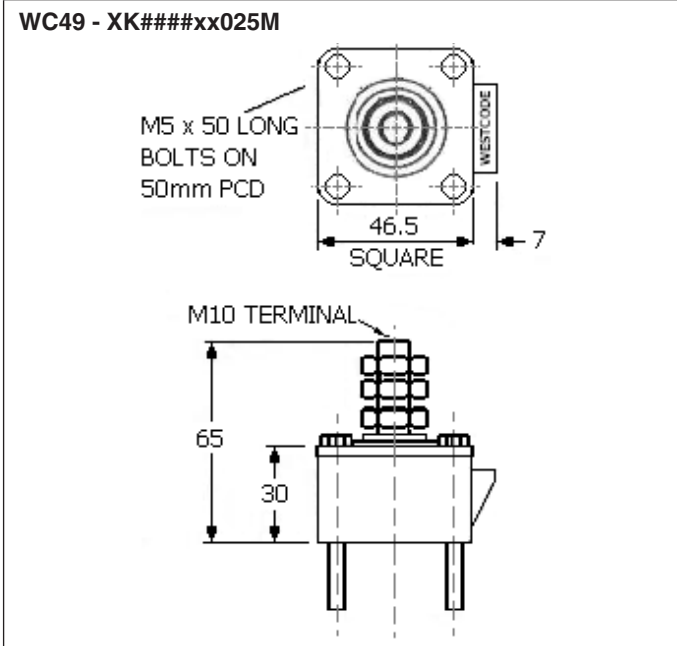

Dimensions in mm and inches (1 mm = 0.0394")

WC55 - SK3800DA116Mxxx

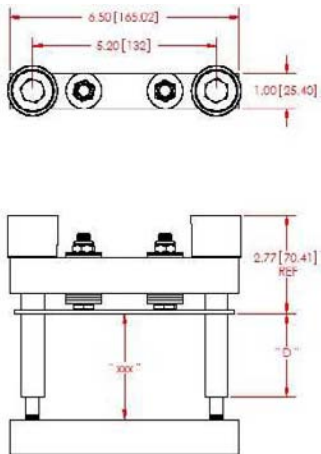

Notes:

1. DIMENSIONS IN INCHES [MILLIMETERS].
2. " Z " DIMENSION CAN BE CHANGED AS PER REQUIREMENT.
3. " D " DIMENSION CAN BE CHANGED AS PER REQUIREMENT

WC56 - XSK4400DA116Mxxx

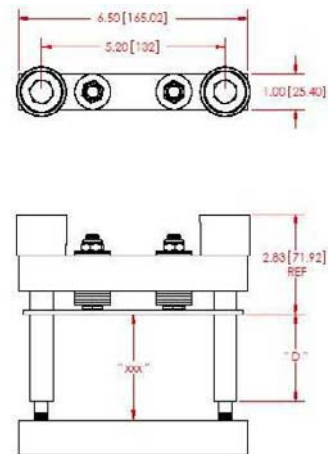

Notes:

1. DIMENSIONS IN INCHES [MILLIMETERS].
2. " Z " DIMENSION CAN BE CHANGED AS PER REQUIREMENT.
3. " D " DIMENSION CAN BE CHANGED AS PER REQUIREMENT.

WC57 - XSK6000DA116Mxxx

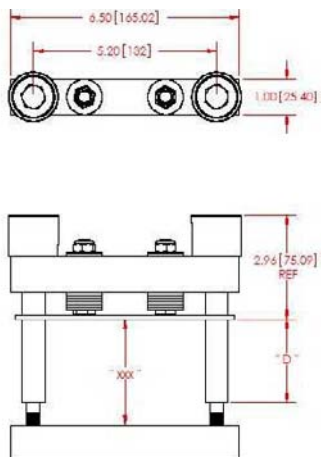

Notes:

1. DIMENSIONS IN INCHES [MILLIMETERS].
2. " Z " DIMENSION CAN BE CHANGED AS PER REQUIREMENT.
3. " D " DIMENSION CAN BE CHANGED AS PER REQUIREMENT

WC58- DA

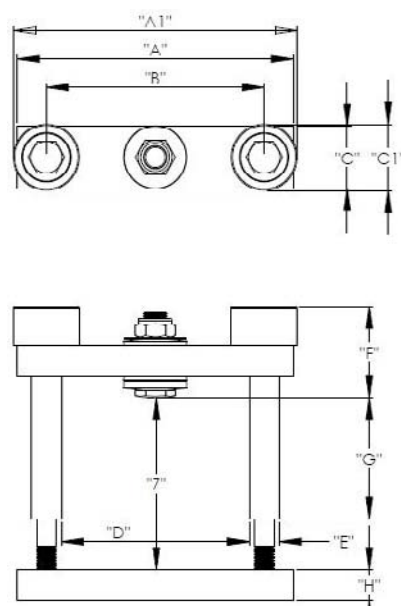

WC59 - DT

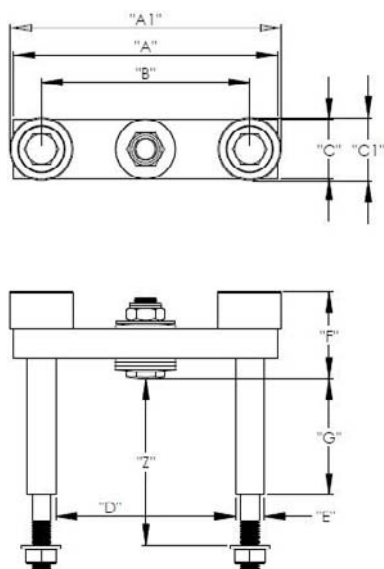

WC60 - DF

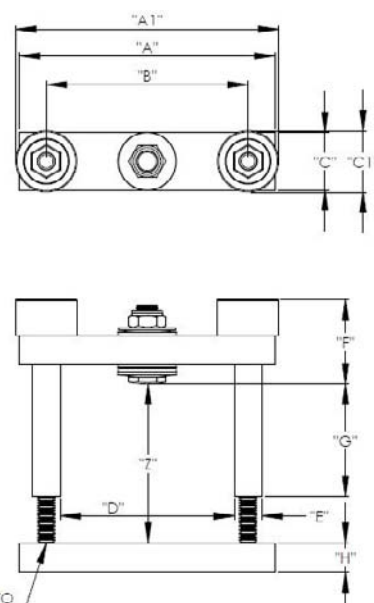

Dimensions in mm and inches (1 mm = 0.0394")

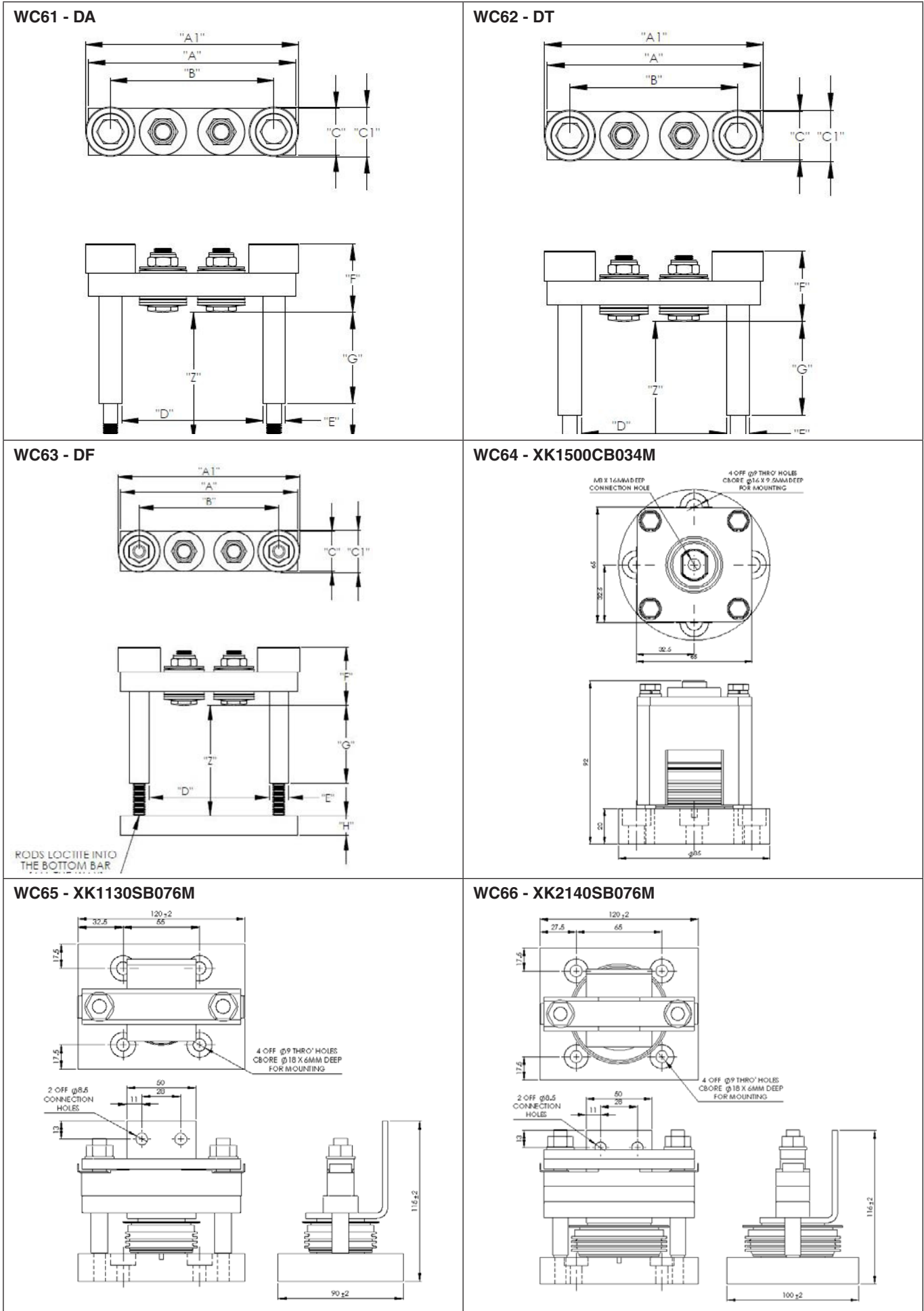

Outline drawings

Dimensions in mm and inches (1 mm = 0.0394")

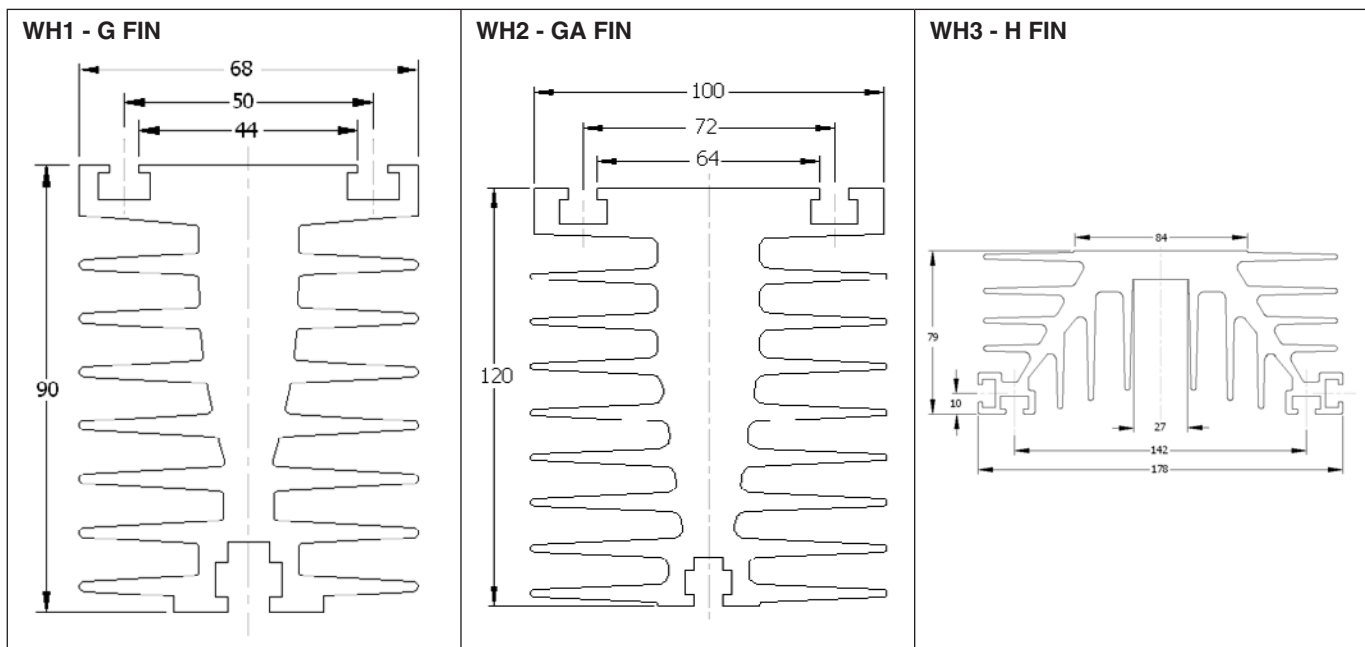
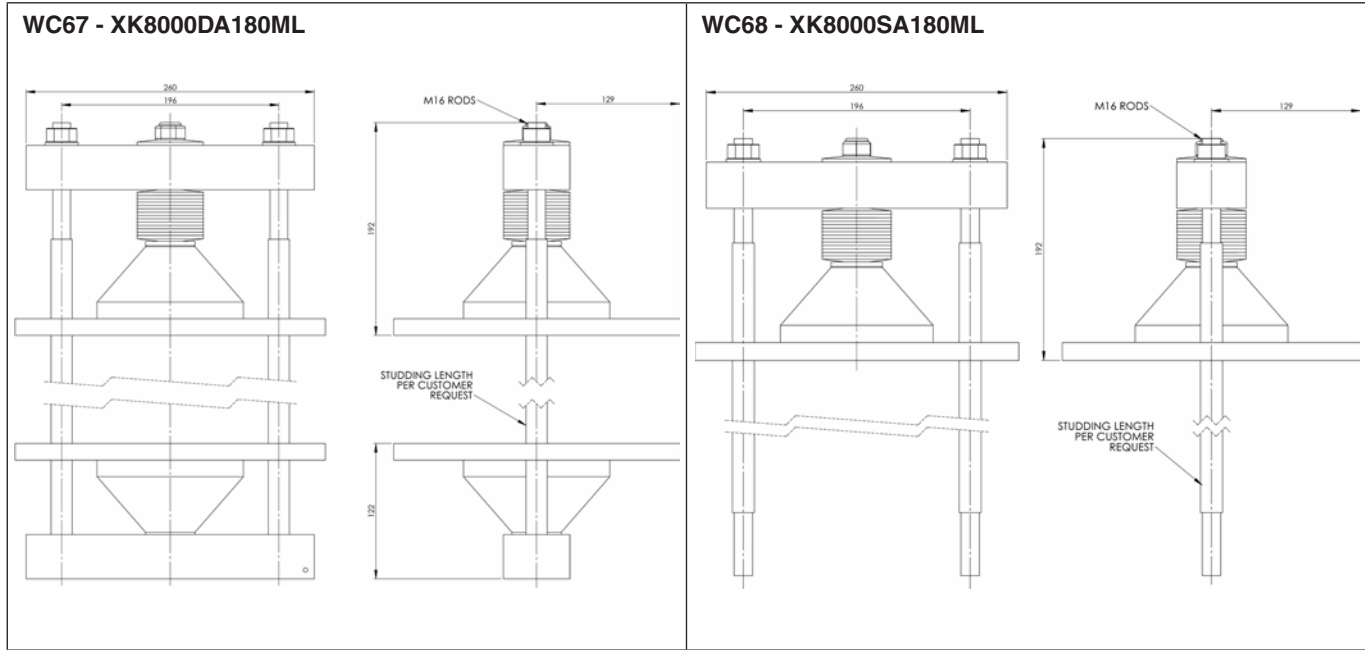

Dimensions in mm and inches (1 mm = 0.0394")

<p>WH4 - T FIN</p>	<p>WH5 - TB FIN</p>	<p>WH6 - TC FIN</p>
<p>WH7 - LP100</p>	<p>WH8 - WS46</p>	<p>WH9 - WS30 - COPPER</p>
<p>WCL1 - LK COOLER</p> <p>Nozzles suitable for 10mm hose</p>	<p>WCL2 - LKA COOLER</p> <p>Nozzels suitable for 10mm Hose</p>	<p>WCL3 - LKB COOLER</p> <p>Nozzels suitable for 12mm Hose</p>

Dimensions in mm and inches (1 mm = 0.0394")

<p>WCL4 - LKC COOLER</p> <p>Nozzels suitable for 12mm Hose</p>	<p>WCL5 - LKD COOLER</p> <p>Nozzle suitable for 12mm hose</p>	<p>WCL6 - LKE COOLER</p> <p>Nozzels suitable for 12mm hose</p>
<p>WCL7 - LKF</p> <p>Nozzels suitable for 12mm hose</p>	<p>WCL8 - WS27</p>	<p>WCL9 - WS65 COOLER</p>
<p>WCL10 - WS69 COOLER</p>	<p>WCL11 - WS70 COOLER</p>	<p>WCL12 - WS71-1 COOLER</p>

Dimensions in mm and inches (1 mm = 0.0394")

<p>WCL13 - WS71-2 COOLER</p> <p>Nozzle suitable for 10mm hose</p> <p>30.1</p> <p>60.2</p>	<p>WCL14 - WS72-1 COOLER</p> <p>Nozzle suitable for 12mm hose</p> <p>46</p> <p>175</p> <p>64</p> <p>26</p> <p>60</p> <p>85</p> <p>90</p>	<p>WCL15 - WS72-2 COOLER</p> <p>Nozzle suitable for 12mm hose</p> <p>40</p> <p>90</p>
<p>WCL16 - XW127ExxxA</p> <p>23</p> <p>54</p> <p>20</p> <p>4</p> <p>25</p> <p>4</p> <p>2 OFF 1/4" BSPP x 18mm DEEP</p> <p>100</p> <p>50</p> <p>98.7</p> <p>100</p> <p>50</p>	<p>WCL17 - XW127ExxxB</p> <p>23</p> <p>54</p> <p>30</p> <p>4</p> <p>31</p> <p>4</p> <p>2 OFF 1/4" BSPP x 18mm DEEP</p> <p>100</p> <p>50</p> <p>98.7</p> <p>25</p> <p>25</p> <p>18</p> <p>18</p> <p>71</p> <p>208</p> <p>322</p> <p>2 HOLE Ø11</p>	<p>WCL18 - XW180GN25A</p> <p>115</p> <p>55</p> <p>15</p> <p>100</p>
<p>WCL19 - XW180BxxxE</p> <p>26</p> <p>90</p> <p>25</p> <p>34</p> <p>4</p> <p>4</p> <p>2 OFF 3/8" BSPP X34MM DEEP</p> <p>142</p> <p>71</p> <p>73.50</p> <p>147</p> <p>Ø134</p>	<p>WCL20 - XW180BxxxF</p> <p>26</p> <p>90</p> <p>25</p> <p>34</p> <p>4</p> <p>10</p> <p>2 OFF 3/8" BSPP X34MM DEEP</p> <p>242</p> <p>71</p> <p>142</p> <p>Ø134</p> <p>13.50</p> <p>20</p> <p>40</p> <p>80</p> <p>40</p> <p>20</p>	

Dimensions in mm and inches (1 mm = 0.0394")

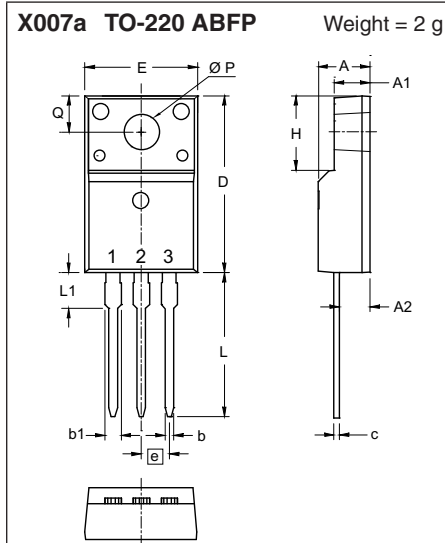

Dim.	Millimeters		Inches	
	min	max	min	max
A	4.50	4.90	0.177	0.193
A1	2.34	2.74	0.092	0.108
A2	2.56	2.96	0.101	0.117
b	0.70	0.90	0.028	0.035
b1	1.27	1.47	0.050	0.058
c	0.45	0.60	0.018	0.024
D	15.67	16.07	0.617	0.633
E	9.96	10.36	0.392	0.408
e	2.54 BSC		0.100 BSC	
H	6.48	6.88	0.255	0.271
L	12.68	13.28	0.499	0.523
L1	3.03	3.43	0.119	0.135
Ø P	3.08	3.28	0.121	0.129
Q	3.20	3.40	0.126	0.134

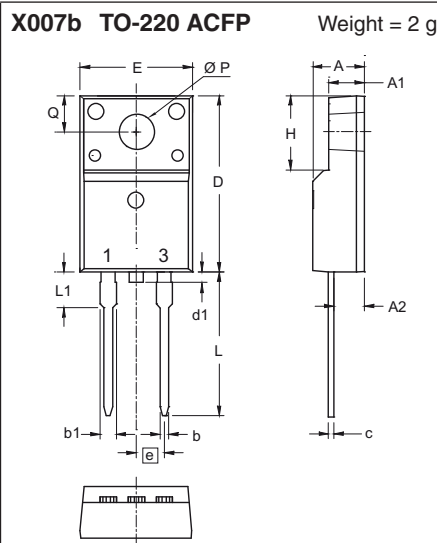

Dim.	Millimeters		Inches	
	min	max	min	max
A	4.50	4.90	0.177	0.193
A1	2.34	2.74	0.092	0.108
A2	2.56	2.96	0.101	0.117
b	0.70	0.90	0.028	0.035
b1	1.27	1.47	0.050	0.058
c	0.45	0.60	0.018	0.024
D	15.67	16.07	0.617	0.633
d1	0.00	1.10	0.000	0.043
E	9.96	10.36	0.392	0.408
e	2.54 BSC		0.100 BSC	
H	6.48	6.88	0.255	0.271
L	12.68	13.28	0.499	0.523
L1	3.03	3.43	0.119	0.135
Ø P	3.08	3.28	0.121	0.129
Q	3.20	3.40	0.126	0.134

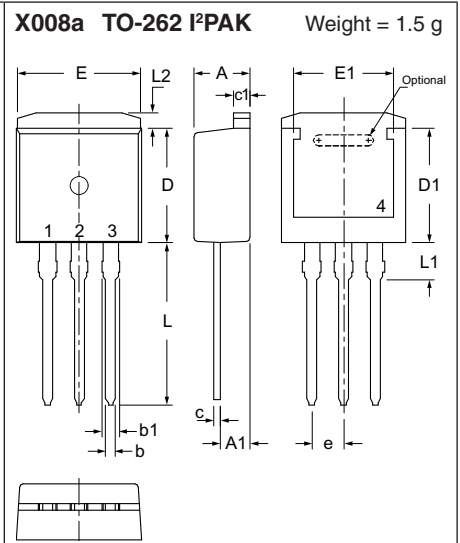

Dim.	Millimeters		Inches	
	min	max	min	max
A	4.30	4.70	0.169	0.185
A1	2.20	2.60	0.087	0.102
b	0.70	0.90	0.028	0.035
b1	1.37	1.57	0.054	0.062
c	0.45	0.60	0.018	0.024
c1	1.25	1.40	0.049	0.055
D	9.00	9.40	0.355	0.370
D1	7.20		0.284	
E	9.70	9.90	0.382	0.390
E1	7.00		0.276	
e	2.54 BSC		0.100 BSC	
L	12.88	13.28	0.507	0.523
L1	3.00	-	0.118	-
L2	1.00	1.40	0.039	0.055

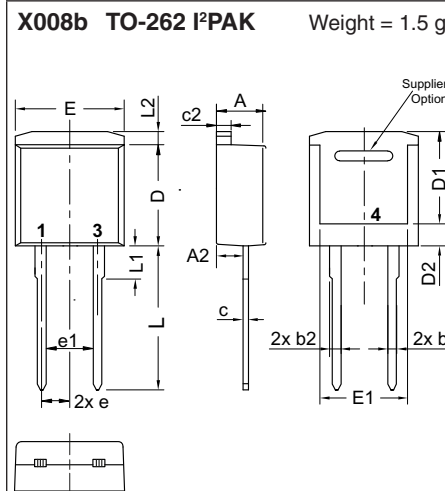

Dim.	Millimeters		Inches	
	min	max	min	max
A	4.06	4.83	0.160	0.190
A2	2.41		0.095	
b	0.51	0.99	0.020	0.039
b2	1.14	1.40	0.045	0.055
c	0.40	0.74	0.016	0.029
c2	1.14	1.40	0.045	0.055
D	8.38	9.40	0.330	0.370
D1	8.00	8.89	0.315	0.350
D2	2.5		0.098	
E	9.65	10.41	0.380	0.410
E1	6.22	8.50	0.245	0.335
e	2.54 BSC		0.100 BSC	
e1	4.28		0.169	
L	13.00	13.60	0.512	0.535
L1	2.90	3.10	0.114	0.122
L2	1.02	1.68	0.040	0.066

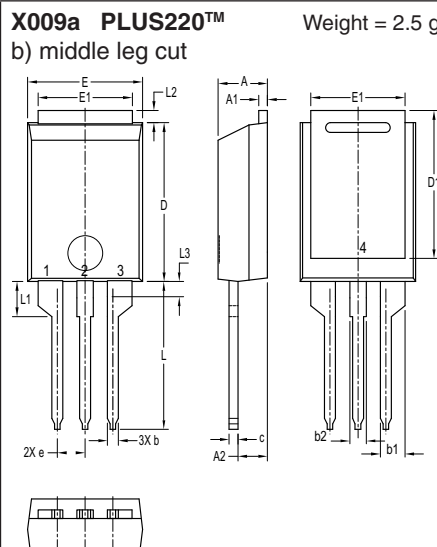

Dim.	Millimeters		Inches	
	min	max	min	max
A	4.30	4.70	0.169	0.185
A1	0.70	0.90	0.028	0.035
A2	2.50	3.00	0.098	0.118
b	0.90	1.20	0.035	0.047
b1	2.03	2.41	0.080	0.095
b2	1.37	1.63	0.054	0.064
c	0.70	0.90	0.028	0.035
D	14.00	15.00	0.551	0.591
D1	13.00	13.70	0.512	0.539
E	10.00	11.00	0.394	0.433
E1	8.40	8.80	0.331	0.346
e	2.54 BSC		0.100 BSC	
L	13.00	14.00	0.512	0.551
L1	3.00	3.50	0.118	0.138
L2	0.90	1.30	0.035	0.051
L3	1.20	1.50	0.047	0.059

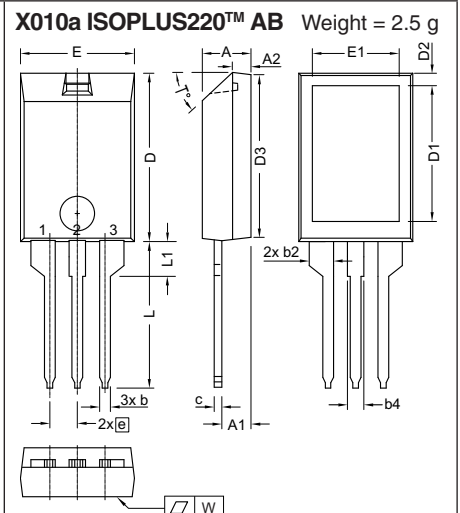

Dim.	Millimeters		Inches	
	min	max	min	max
A	4.00	5.00	0.157	0.197
A1	2.50	3.00	0.098	0.118
A2	1.60	1.80	0.063	0.071
b	0.90	1.30	0.035	0.051
b2	2.35	2.55	0.093	0.100
b4	1.25	1.65	0.049	0.065
c	0.70	1.00	0.028	0.039
D	15.00	16.00	0.591	0.630
D1	12.00	13.00	0.472	0.512
D2	1.10	1.50	0.043	0.059
D3	14.90	15.50	0.587	0.610
E	10.00	11.00	0.394	0.433
E1	7.50	8.50	0.295	0.335
e	2.54 BSC		0.100 BSC	
L	13.00	14.50	0.512	0.571
L1	3.00	3.50	0.118	0.138
T°	42.5	47.5	-	-
W	-	0.10	-	0.004

Dimensions in mm and inches (1 mm = 0.0394")

X010b ISOPLUS220™ AC Weight = 2.5 g

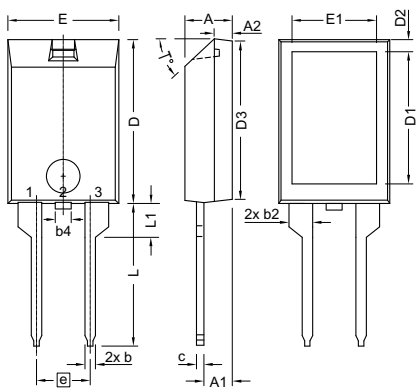

Dim.	Millimeters		Inches	
	min	max	min	max
A	4.00	5.00	0.157	0.197
A1	2.50	3.00	0.098	0.118
A2	1.60	1.80	0.063	0.071
b	0.90	1.30	0.035	0.051
b2	1.25	1.65	0.049	0.065
b4	2.35	2.55	0.093	0.100
c	0.70	1.00	0.028	0.039
D	15.00	16.00	0.591	0.630
D1	12.00	13.00	0.472	0.512
D2	1.10	1.50	0.043	0.059
D3	14.90	15.50	0.587	0.610
E	10.00	11.00	0.394	0.433
E1	7.50	8.50	0.295	0.335
e	5.08 BSC		0.200 BSC	
L	13.00	14.50	0.512	0.571
L1	3.00	3.50	0.118	0.138
T°	42.5	47.5		
W	-	0.10	-	0.004

X011a TO-263 AA (D²PAK) Weight = 1.5 g

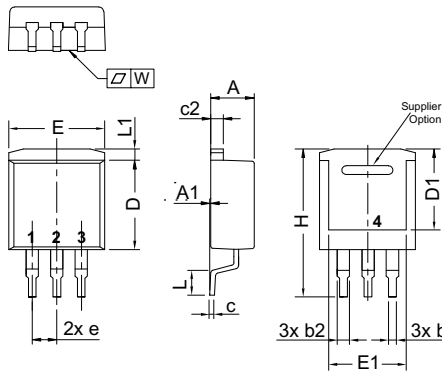

Dim.	Millimeters		Inches	
	min	max	min	max
A	4.06	4.83	0.160	0.190
A1	typ. 0.10		typ. 0.004	
b	0.51	0.99	0.020	0.039
b2	1.14	1.40	0.045	0.055
c	0.40	0.74	0.016	0.029
c2	1.14	1.40	0.045	0.055
D	8.38	9.40	0.330	0.370
D1	8.00	8.89	0.315	0.350
E	9.65	10.41	0.380	0.410
E1	6.22	8.13	0.245	0.320
e	2.54 BSC		0.100 BSC	
H	14.61	15.88	0.575	0.625
L	1.78	2.79	0.070	0.110
L1	1.02	1.68	0.040	0.066
W	typ. 0.02	0.040	typ. 0.0008	0.002

X011b TO-263 AB (D²PAK) Weight = 1.5 g

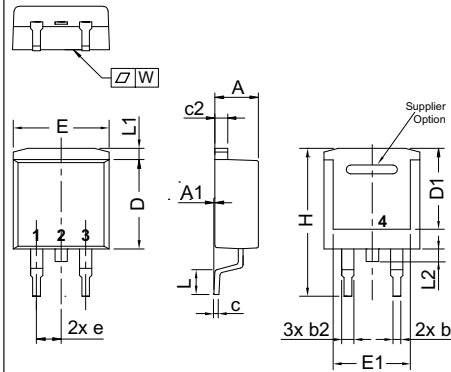

Dim.	Millimeters		Inches	
	min	max	min	max
A	4.06	4.83	0.160	0.190
A1	typ. 0.10		typ. 0.004	
b	0.51	0.99	0.020	0.039
b2	1.14	1.40	0.045	0.055
c	0.40	0.74	0.016	0.029
c2	1.14	1.40	0.045	0.055
D	8.38	9.40	0.330	0.370
D1	8.00	8.89	0.315	0.350
E	9.65	10.41	0.380	0.410
E1	6.22	8.13	0.245	0.320
e	2.54 BSC		0.100 BSC	
H	14.61	15.88	0.575	0.625
L	1.78	2.79	0.070	0.110
L1	1.02	1.68	0.040	0.066
W	typ. 0.02	0.040	typ. 0.0008	0.002

X011c TO-263 AB (D²PAK HV) Weight = 1.5 g

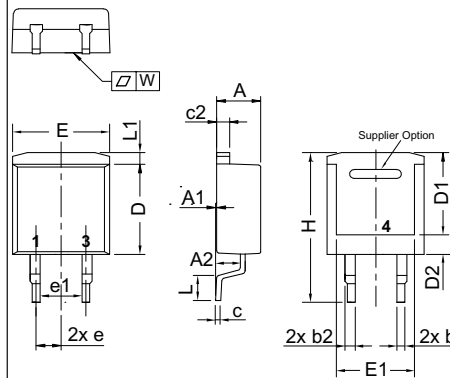

Dim.	Millimeters		Inches	
	min	max	min	max
A	4.06	4.83	0.160	0.190
A1	typ. 0.10		typ. 0.004	
A2	2.41		0.095	
b	0.51	0.99	0.020	0.039
b2	1.14	1.40	0.045	0.055
c	0.40	0.74	0.016	0.029
c2	1.14	1.40	0.045	0.055
D	8.38	9.40	0.330	0.370
D1	8.00	8.89	0.315	0.350
D2	2.5		0.098	
E	9.65	10.41	0.380	0.410
E1	6.22	8.50	0.245	0.335
e	2.54 BSC		0.100 BSC	
e1	4.28		0.169	
H	14.61	15.88	0.575	0.625
L	1.78	2.79	0.070	0.110
L2	1.02	1.68	0.040	0.066
W	typ. 0.02	0.040	typ. 0.0008	0.002

X012a TO-263 (5) Weight = 1.5 g

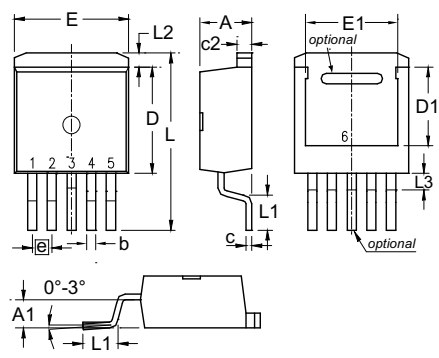

Dim.	Millimeters		Inches	
	min	max	min	max
A	4.20	4.80	0.160	0.190
A1	2.10	2.70	0.083	0.106
b	0.60	0.99	0.024	0.039
c	0.40	0.70	0.016	0.028
c2	1.20	1.40	0.047	0.055
D	8.80	9.50	0.346	0.374
D1	6.60	7.20	0.260	0.283
E	9.65	10.30	0.380	0.406
E1	7.50	8.20	0.295	0.323
e	1.70 BSC		0.067 BSC	
L	14.80	15.80	0.583	0.622
L1	2.24	2.84	0.088	0.112
L2	1.00	1.40	0.039	0.067
L3	1.20	1.70	0.047	0.067

X012b TO-263 (7) c) middle leg cut Weight = 2.5 g

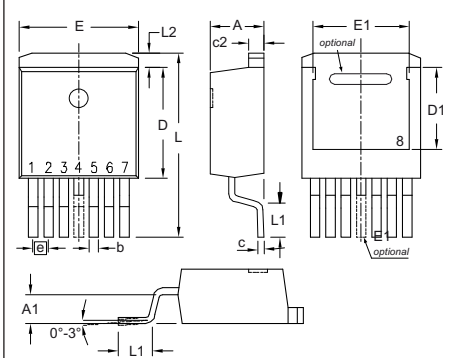

Dim.	Millimeters		Inches	
	min	max	min	max
A	4.20	4.60	0.165	0.181
A1	2.45	2.75	0.096	0.108
b	0.65	0.90	0.026	0.035
c	0.40	0.60	0.016	0.024
c2	1.14	1.40	0.045	0.055
D	8.38	8.64	0.330	0.340
D1	6.10	6.35	0.240	0.250
E	10.00	10.30	0.394	0.406
E1	7.34	8.00	0.290	0.315
e	1.27 BSC		0.050 BSC	
L	14.73	15.75	0.580	0.620
L1	2.24	2.84	0.088	0.112
L2	1.35	1.55	0.053	0.061

Dimensions in mm and inches (1 mm = 0.0394")

X013 PLUS220™ (SMD) Weight = 2 g

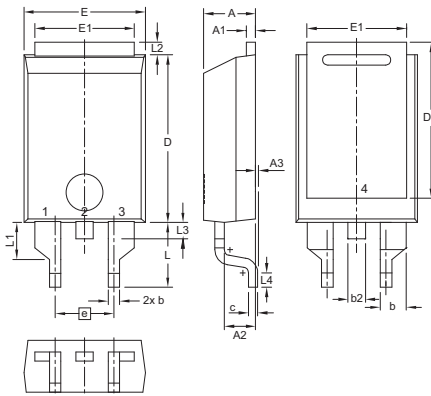

Dim.	Millimeters		Inches	
	min	max	min	max
A	4.30	4.70	0.169	0.185
A1	0.70	0.90	0.028	0.035
A2	2.50	3.00	0.098	0.118
A3	0.00	0.25	0.000	0.010
b	0.90	1.20	0.035	0.047
b1	2.03	2.41	0.080	0.095
b2	1.37	1.63	0.054	0.064
c	0.70	0.90	0.028	0.035
D	14.00	15.00	0.551	0.591
D1	13.00	13.70	0.512	0.539
E	10.00	11.00	0.394	0.433
E1	8.40	8.80	0.331	0.346
e	5.08 BSC		0.200 BSC	
L	5.30	5.80	0.209	0.228
L1	3.00	3.50	0.118	0.138
L2	0.90	1.30	0.035	0.051
L3	1.20	1.50	0.047	0.059
L4	1.00	1.50	0.039	0.059

X014a TO-247 AD Weight = 6 g

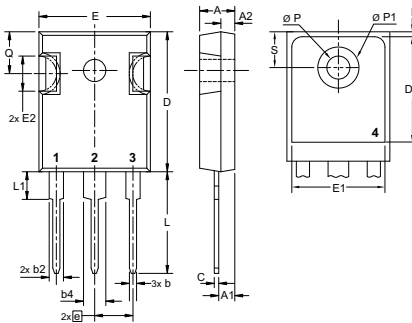

Dim.	Millimeters		Inches	
	min	max	min	max
A	4.70	5.30	0.185	0.209
A1	2.21	2.59	0.087	0.102
A2	1.50	2.49	0.059	0.098
b	0.99	1.40	0.039	0.055
b2	1.65	2.39	0.065	0.094
b4	2.59	3.43	0.102	0.135
c	0.38	0.89	0.015	0.035
D	20.79	21.45	0.819	0.845
D1	13.07	-	0.515	-
D2	0.51	1.35	0.020	0.053
E	15.48	16.24	0.610	0.640
E1	13.45	-	0.53	-
E2	4.31	5.48	0.170	0.216
e	5.45 BSC		0.215 BSC	
L	19.80	20.30	0.078	0.800
L1	-	4.49	-	0.177
Ø P	3.55	3.65	0.140	0.144
Ø P1	-	7.39	-	0.290
Q	5.38	6.19	0.212	0.244
S	6.14 BSC		0.242 BSC	

X014b TO-247 AD Weight = 6 g

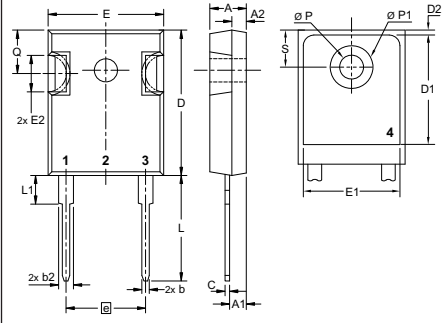

Dim.	Millimeters		Inches	
	min	max	min	max
A	4.70	5.30	0.185	0.209
A1	2.21	2.59	0.087	0.102
A2	1.50	2.49	0.059	0.098
b	0.99	1.40	0.039	0.055
b2	1.65	2.39	0.065	0.094
b4	2.59	3.43	0.102	0.135
c	0.38	0.89	0.015	0.035
D	20.79	21.45	0.819	0.845
D1	13.07	-	0.515	-
D2	0.51	1.35	0.020	0.053
E	15.48	16.24	0.610	0.640
E1	13.45	-	0.530	-
E2	4.31	5.48	0.170	0.216
e	10.90 BSC		0.430 BSC	
L	19.80	20.30	0.078	0.800
L1	-	4.49	-	0.177
Ø P	3.55	3.65	0.140	0.144
Ø P1	-	7.39	-	0.290
Q	5.38	6.19	0.212	0.244
S	6.14 BSC		0.242 BSC	

X014c TO-247 AD Weight = 6 g

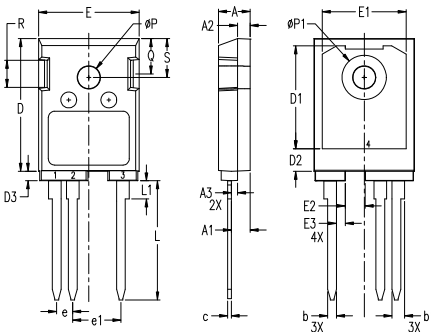

Dim.	Millimeters		Inches	
	min	max	min	max
A	4.90	5.10	0.193	0.201
A1	2.90	3.10	0.114	0.122
A2	1.90	2.10	0.075	0.083
A3	0.90	1.10	0.035	0.043
b	1.35	1.50	0.053	0.059
b1	1.90	2.10	0.075	0.083
c	0.55	0.75	0.022	0.030
D	20.80	21.40	0.819	0.843
D1	16.20	16.40	0.638	0.646
D2	3.40	3.70	0.134	0.146
D3	1.40	1.60	0.055	0.063
E	15.80	16.20	0.622	0.638
E1	13.20	13.40	0.520	0.528
E2	3.00	3.20	0.118	0.126
E3	1.30	1.50	0.051	0.059
e	2.54 BSC		0.100 BSC	
e1	7.62 BSC		0.300 BSC	
L	18.60	19.00	0.732	0.748
L1	2.70	3.00	0.106	0.118
Ø P	3.50	3.60	0.138	0.142
Ø P1	6.90	7.10	0.272	0.280
Q	5.50	5.70	0.216	0.224
R	4.20	4.30	0.165	0.169
S	6.10	6.30	0.240	0.248

X015a PLUS247™ Weight = 7 g

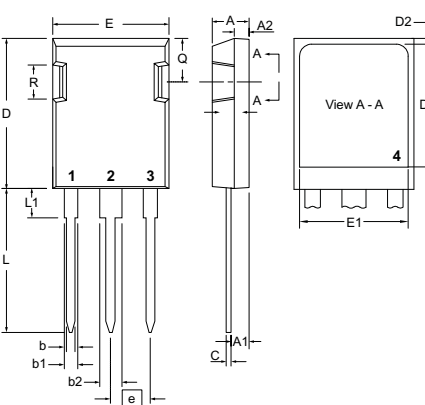

Dim.	Millimeters		Inches	
	min	max	min	max
A	4.83	5.21	0.190	0.205
A1	2.29	2.54	0.090	0.100
A2	1.91	2.16	0.075	0.085
b	1.14	1.40	0.045	0.055
b1	1.90	2.10	0.075	0.084
b2	2.92	3.12	0.115	0.123
C	0.60	0.80	0.024	0.031
D	20.80	21.34	0.819	0.840
E	15.75	16.13	0.620	0.635
e	5.45 BSC		0.215 BSC	
L	19.80	20.30	0.078	0.800
L1	3.80	4.30	0.150	0.170
Q	5.60	6.20	0.220	0.244
R	4.32	4.83	0.170	0.190

X015c PLUS247™ Weight = 7 g

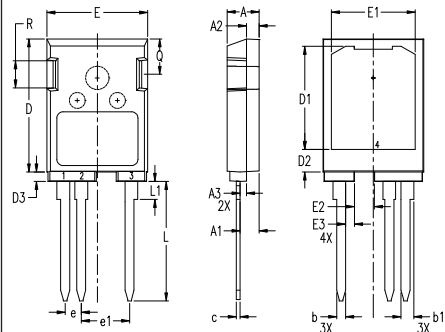

Dim.	Millimeters		Inches	
	min	max	min	max
A	4.90	5.10	0.193	0.201
A1	2.90	3.10	0.114	0.122
A2	1.90	2.10	0.075	0.083
A3	0.90	1.10	0.035	0.043
b	1.35	1.50	0.053	0.059
b1	1.90	2.10	0.075	0.083
c	0.55	0.75	0.022	0.030
D	20.80	21.40	0.819	0.843
D1	16.20	16.40	0.638	0.646
D2	3.40	3.70	0.134	0.146
D3	1.40	1.60	0.055	0.063
E	15.80	16.20	0.622	0.638
E1	13.20	13.40	0.520	0.528
E2	3.00	3.20	0.118	0.126
E3	1.30	1.50	0.051	0.059
e	2.54 BSC		0.100 BSC	
e1	7.62 BSC		0.300 BSC	
L	18.60	19.00	0.732	0.748
L1	2.70	3.00	0.106	0.118
Q	5.50	5.70	0.216	0.224
R	4.20	4.30	0.165	0.169

Dimensions in mm and inches (1 mm = 0.0394")

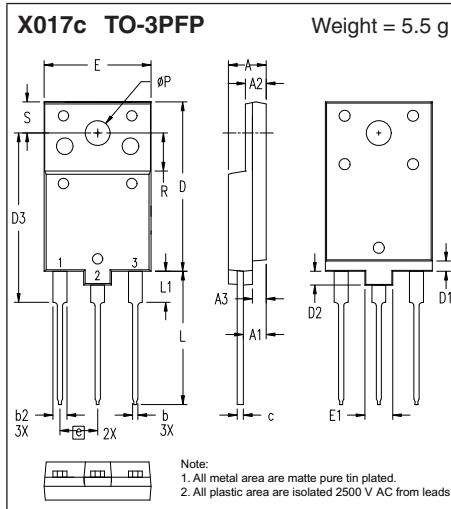

Dim.	Millimeters		Inches	
	min	max	min	max
A	5.40	5.80	0.213	0.228
A1	3.10	3.50	0.122	0.138
A2	2.90	3.30	0.114	0.130
A3	1.90	2.30	0.075	0.091
b	0.65	0.95	0.026	0.037
b2	1.90	2.30	0.075	0.091
c	0.80	1.10	0.031	0.043
D	24.30	24.70	0.957	0.972
D1	1.30	1.70	0.051	0.067
D2	1.80	2.2	0.071	0.087
E	15.40	15.80	0.606	0.622
E1	3.90	4.30	0.154	0.169
e	5.45 BSC		0.215 BSC	
L	19.00	19.50	0.748	0.768
L1	4.30	4.70	0.169	0.185
Ø P	3.40	3.80	0.134	0.150
R	5.30	5.70	0.209	0.224
S	4.30	4.70	0.169	0.185

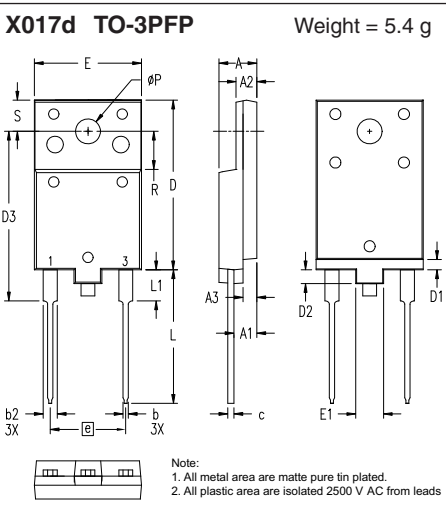

Dim.	Millimeters		Inches	
	min	max	min	max
A	5.40	5.80	0.213	0.228
A1	3.10	3.50	0.122	0.138
A2	2.90	3.30	0.114	0.130
A3	1.90	2.30	0.075	0.091
b	0.65	0.95	0.026	0.037
b2	1.90	2.30	0.075	0.091
c	0.80	1.10	0.031	0.043
D	24.30	24.70	0.957	0.972
D1	1.30	1.70	0.051	0.067
D2	1.80	2.2	0.071	0.087
E	15.40	15.80	0.606	0.622
E1	3.90	4.30	0.154	0.169
e	10.9 BSC		0.430 BSC	
L	19.00	19.50	0.748	0.768
L1	4.30	4.70	0.169	0.185
Ø P	3.40	3.80	0.134	0.150
R	5.30	5.70	0.209	0.224
S	4.30	4.70	0.169	0.185

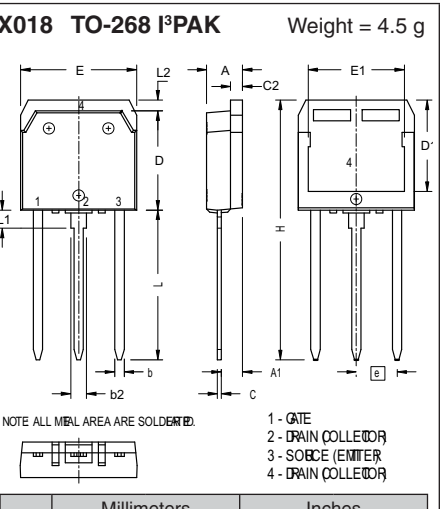

Dim.	Millimeters		Inches	
	min	max	min	max
A	4.90	5.10	0.193	0.201
A1	2.70	2.90	0.106	0.114
b	1.15	1.45	0.045	0.057
b2	1.90	2.10	0.075	0.083
C	0.40	0.65	0.016	0.026
C 2	1.45	1.60	0.057	0.063
D	13.80	14.00	0.543	0.551
D1	12.40	12.70	0.488	0.500
E	15.85	16.05	0.624	0.632
E1	13.30	13.60	0.524	0.535
e	5.45 BSC		0.215 BSC	
H	34.67	35.43	1.365	1.395
L	19.81	20.32	0.780	0.800
L1	2.00	2.30	0.079	0.091
L2	1.00	1.15	0.039	0.045

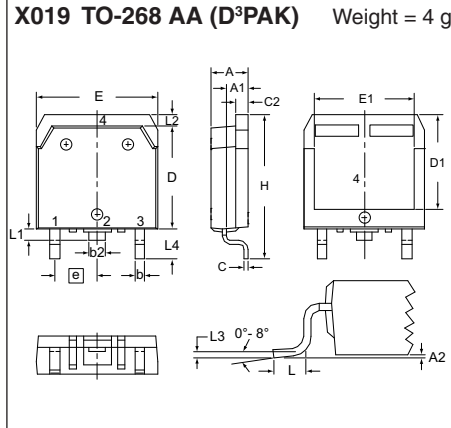

Dim.	Millimeters		Inches	
	min	max	min	max
A	4.90	5.10	0.193	0.201
A1	2.70	2.90	0.106	0.114
A2	0.02	0.25	0.001	0.100
b	1.15	1.45	0.045	0.057
b2	1.90	2.10	0.075	0.083
C	0.40	0.65	0.016	0.026
C 2	1.45	1.60	0.057	0.063
D	13.80	14.00	0.543	0.551
D1	12.40	12.70	0.488	0.500
E	15.85	16.05	0.624	0.632
E1	13.30	13.60	0.524	0.535
e	5.45 BSC		0.215 BSC	
H	18.70	19.10	0.736	0.752
L	2.40	2.70	0.094	0.106
L1	1.20	1.40	0.047	0.055
L2	1.00	1.15	0.039	0.045
L3	2.54 BSC		0.100 BSC	
L4	3.80	4.10	0.150	0.161

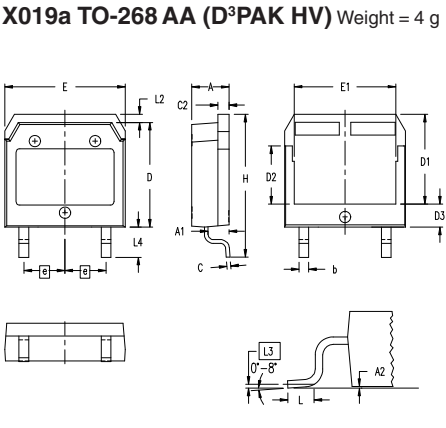

Dim.	Millimeters		Inches	
	min	max	min	max
A	4.90	5.10	0.193	0.201
A1	2.70	2.90	0.106	0.114
A2	0.02	0.25	0.001	0.100
b	1.15	1.45	0.045	0.057
C	0.40	0.65	0.016	0.026
C 2	1.45	1.60	0.057	0.063
D	13.80	14.00	0.543	0.551
D1	11.80	12.10	0.465	0.476
D2	7.50	7.80	0.295	0.307
D3	2.90	3.20	0.114	0.126
E	15.85	16.05	0.624	0.632
E1	13.30	13.60	0.524	0.535
e	5.45 BSC		0.215 BSC	
H	18.70	19.10	0.736	0.752
L	1.70	2.00	0.067	0.079
L2	1.00	1.15	0.039	0.045
L3	0.25 BSC		0.010 BSC	
L4	3.80	4.10	0.150	0.161

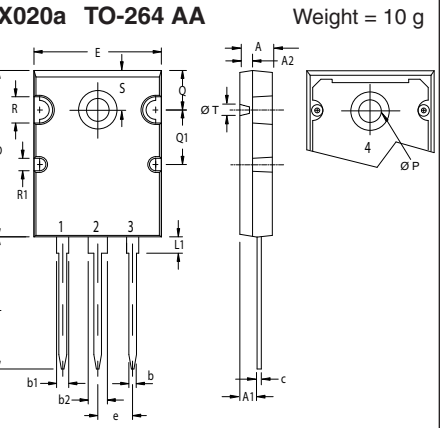

Dim.	Millimeters		Inches	
	min	max	min	max
A	4.82	5.13	0.190	0.202
A1	2.54	2.89	0.100	0.114
A2	2.00	2.10	0.079	0.083
b	1.12	1.42	0.044	0.056
b2	2.90	3.09	0.114	0.122
c	0.53	0.83	0.021	0.033
D	25.91	26.16	1.020	1.030
E	19.81	19.96	0.780	0.786
e	5.45 BSC		0.215 BSC	
J	0.00	0.25	0.000	0.010
K	0.00	0.25	0.000	0.010
L	20.32	20.83	0.800	0.820
L1	2.29	2.59	0.090	0.102
P	3.17	2.66	0.125	0.144
Q	6.07	6.27	0.239	0.247
Q1	8.38	8.69	0.330	0.342
R	3.81	4.32	0.150	0.170
R1	1.78	2.29	0.070	0.090
S	6.04	6.30	0.238	0.248
T	1.57	1.83	0.062	0.072

Dimensions in mm and inches (1 mm = 0.0394")

X021a PLUS264™ Weight = 10 g

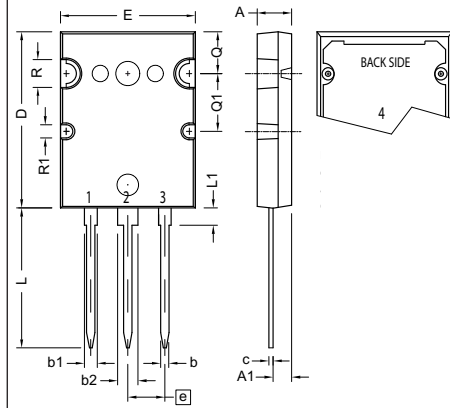

Dim.	Millimeters		Inches	
	min	max	min	max
A	4.70	5.31	0.185	0.209
A1	2.59	3.00	0.102	0.118
b	0.94	1.40	0.037	0.055
b1	2.21	2.59	0.087	0.102
b2	2.79	3.20	0.110	0.126
c	0.43	0.74	0.017	0.029
D	25.58	26.59	1.007	1.047
E	19.30	20.29	0.760	0.799
e	5.45 BSC		0.215 BSC	
L	19.79	21.39	0.779	0.842
L1	2.21	2.59	0.087	0.102
Q	6.10	6.50	0.240	0.256
Q1	8.38	8.79	0.330	0.346
Ø R	3.94	4.75	0.155	0.187
ØR1	2.16	2.36	0.085	0.093

X022a ISOPLUS264™ Weight = 7.5 g

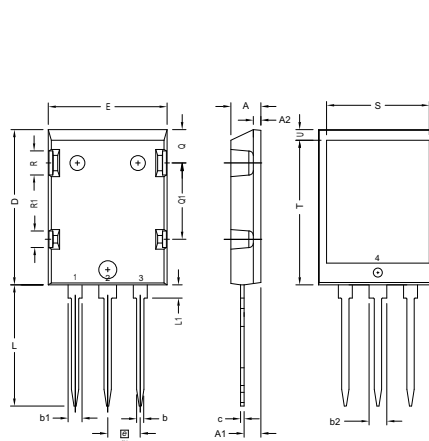

Dim.	Millimeters		Inches	
	min	max	min	max
A	4.83	5.21	0.190	0.205
A1	2.59	3.00	0.102	0.118
A2	1.17	1.40	0.046	0.055
b	1.14	1.40	0.045	0.055
b1	1.60	1.83	0.063	0.072
b2	2.54	2.79	0.100	0.110
b3	1.47	1.73	0.058	0.068
c	0.51	0.74	0.020	0.029
D	25.91	26.42	1.020	1.040
E	19.56	20.29	0.770	0.799
e	3.81 BSC		0.150 BSC	
L	19.81	21.83	0.780	0.820
L1	2.03	2.59	0.080	0.102
Q	5.33	5.97	0.210	0.235
Q1	12.45	13.03	0.490	0.513
R	3.81	4.57	0.150	0.180
R1	2.54	3.30	0.100	0.130
S	16.97	17.53	0.668	0.690
T	20.34	20.85	0.801	0.821
U	1.65	2.03	0.065	0.080

X022 ISOPLUS264™ Weight = 7.5 g

- c) 5 pin
- d) 3 (sym) w/o pin 2 & 4
- e) 3 (HV) w/o pin 3 & 4
- f) 2 (HV) w/o pin 2 & 3 & 4

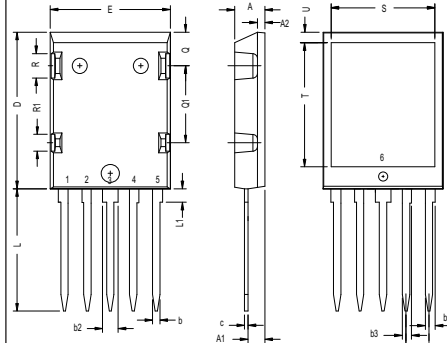

Dim.	Millimeters		Inches	
	min	max	min	max
A	4.83	5.21	0.190	0.205
A1	2.59	3.00	0.102	0.118
A2	1.17	1.40	0.046	0.055
b	1.14	1.40	0.045	0.055
b1	1.60	1.83	0.063	0.072
b2	2.54	2.79	0.100	0.110
b3	1.47	1.73	0.058	0.068
c	0.51	0.74	0.020	0.029
D	25.91	26.42	1.020	1.040
E	19.56	20.29	0.770	0.799
e	3.81 BSC		0.150 BSC	
L	19.81	21.83	0.780	0.820
L1	2.03	2.59	0.080	0.102
Q	5.33	5.97	0.210	0.235
Q1	12.45	13.03	0.490	0.513
R	3.81	4.57	0.150	0.180
R1	2.54	3.30	0.100	0.130
S	16.97	17.53	0.668	0.690
T	20.34	20.85	0.801	0.821
U	1.65	2.03	0.065	0.080

X024a ISOPLUS i4-PAC™ Weight = 6 g

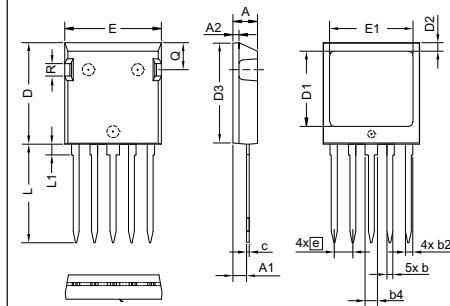

Dim.	Millimeters		Inches	
	min	max	min	max
A	4.83	5.21	0.190	0.205
A1	2.59	3.00	0.102	0.118
A2	1.17	2.16	0.046	0.085
b	1.14	1.40	0.045	0.055
b2	1.47	1.73	0.058	0.068
b4	2.54	2.79	0.100	0.110
c	0.51	0.74	0.020	0.029
D	20.80	21.34	0.819	0.840
D1	14.99	15.75	0.590	0.620
D2	1.65	2.03	0.065	0.080
D3	20.30	20.70	0.799	0.815
E	19.56	20.29	0.770	0.799
E1	16.76	17.53	0.660	0.690
e	3.81 BSC		0.150 BSC	
L	19.81	21.34	0.780	0.840
L1	2.11	2.59	0.083	0.102
Q	5.33	6.20	0.210	0.244
R	2.54	4.57	0.100	0.180
W	-	0.10	-	0.004

X024b ISOPLUS i4-PAC™ Weight = 5.5 g

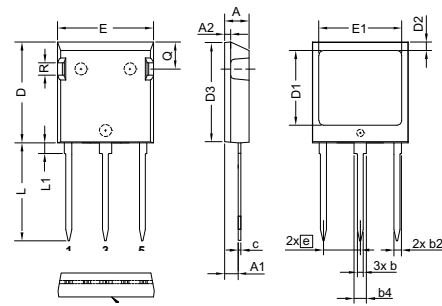

Dim.	Millimeters		Inches	
	min	max	min	max
A	4.83	5.21	0.190	0.205
A1	2.59	3.00	0.102	0.118
A2	1.17	2.16	0.046	0.085
b	1.14	1.40	0.045	0.055
b2	1.47	1.73	0.058	0.068
b4	2.54	2.79	0.100	0.110
c	0.51	0.74	0.020	0.029
D	20.80	21.34	0.819	0.840
D1	14.99	15.75	0.590	0.620
D2	1.65	2.03	0.065	0.080
D3	20.30	20.70	0.799	0.815
E	19.56	20.29	0.770	0.799
E1	16.76	17.53	0.660	0.690
e	7.62 BSC		0.300 BSC	
L	19.81	21.34	0.780	0.840
L1	2.11	2.59	0.083	0.102
Q	5.33	6.20	0.210	0.244
R	2.54	4.57	0.100	0.180
W	-	0.10	-	0.004

X024c ISOPLUS i4-PAC™ Weight = 5.5 g

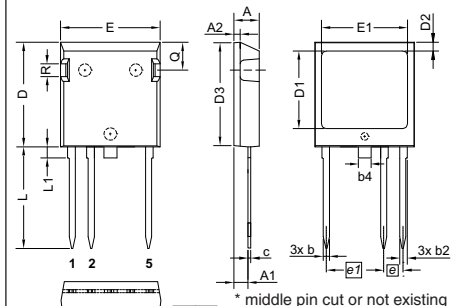

Dim.	Millimeters		Inches	
	min	max	min	max
A	4.83	5.21	0.190	0.205
A1	2.59	3.00	0.102	0.118
A2	1.17	2.16	0.046	0.085
b	1.14	1.40	0.045	0.055
b2	1.47	1.73	0.058	0.068
b4*	2.54	2.79	0.100	0.110
c	0.51	0.74	0.020	0.029
D	20.80	21.34	0.819	0.840
D1	14.99	15.75	0.590	0.620
D2	1.65	2.03	0.065	0.080
D3	20.30	20.70	0.799	0.815
E	19.56	20.29	0.770	0.799
E1	16.76	17.53	0.660	0.690
e	3.81 BSC		0.150 BSC	
e1	11.43 BSC		0.450 BSC	
L	19.81	21.34	0.780	0.840
L1	2.11	2.59	0.083	0.102
Q	5.33	6.20	0.210	0.244
R	2.54	4.57	0.100	0.180
W	-	0.10	-	0.004

* middle pin cut or not existing depending on assembly line

Dimensions in mm and inches (1 mm = 0.0394")

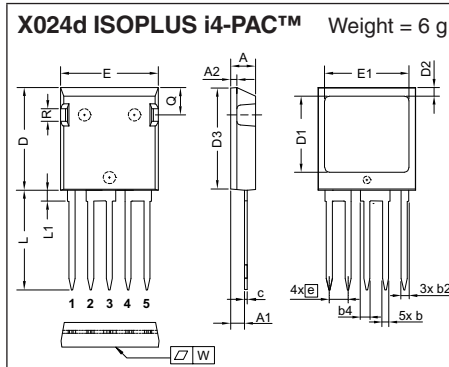

Dim.	Millimeters		Inches	
	min	max	min	max
A	4.83	5.21	0.190	0.205
A1	2.59	3.00	0.102	0.118
A2	1.17	2.16	0.046	0.085
b	1.14	1.40	0.045	0.055
b2	1.47	1.73	0.058	0.068
c	0.51	0.74	0.020	0.029
D	20.80	21.34	0.819	0.840
D1	14.99	15.75	0.590	0.620
D2	1.65	2.03	0.065	0.080
D3	20.30	20.70	0.799	0.815
E	19.56	20.29	0.770	0.799
E1	16.76	17.53	0.660	0.690
e	3.81 BSC		0.150 BSC	
L	19.81	21.34	0.780	0.840
L1	2.11	2.59	0.083	0.102
Q	5.33	6.20	0.210	0.244
R	2.54	4.57	0.100	0.180
W	-	0.10	-	0.004

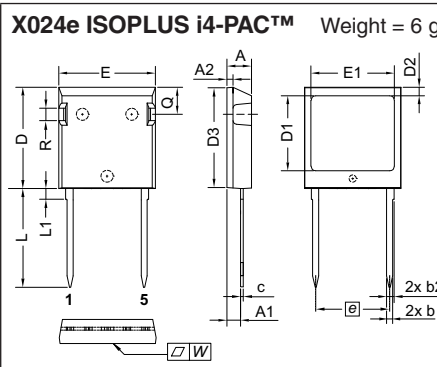

Dim.	Millimeters		Inches	
	min	max	min	max
A	4.83	5.21	0.190	0.205
A1	2.59	3.00	0.102	0.118
A2	1.17	2.16	0.046	0.085
b	1.14	1.40	0.045	0.055
b2	1.47	1.73	0.058	0.068
c	0.51	0.74	0.020	0.029
D	20.80	21.34	0.819	0.840
D1	14.99	15.75	0.590	0.620
D2	1.65	2.03	0.065	0.080
D3	20.30	20.70	0.799	0.815
E	19.56	20.29	0.770	0.799
E1	16.76	17.53	0.660	0.690
e	15.24 BSC		0.600 BSC	
L	19.81	21.34	0.780	0.840
L1	2.11	2.59	0.083	0.102
Q	5.33	6.20	0.210	0.244
R	2.54	4.57	0.100	0.180
W	-	0.10	-	0.004

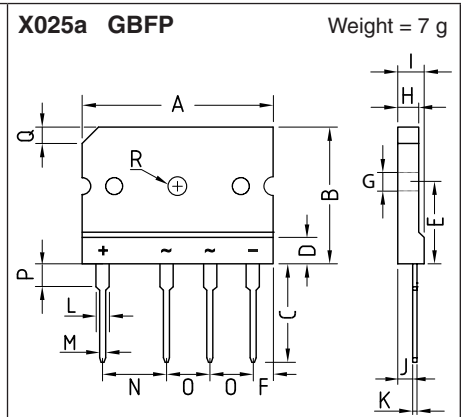

Dim.	Millimeters		Inches	
	min	max	min	max
A	29.70	30.30	1.170	1.194
B	19.70	20.30	0.776	0.800
C	17.00	18.00	0.670	0.709
D	4.70	4.90	0.185	0.193
E	10.80	11.20	0.426	0.441
F	2.30	2.70	0.091	0.106
G	3.10	3.40	0.122	0.134
H	3.40	3.80	0.134	0.150
I	4.40	4.80	0.173	0.189
J	2.50	2.90	0.099	0.114
K	0.60	0.80	0.024	0.032
L	2.00	2.40	0.079	0.095
M	0.90	1.10	0.035	0.043
N	9.80	10.20	0.386	0.402
O	7.30	7.70	0.288	0.303
P	3.80	4.20	0.150	0.165
Q	(3.0) x 45°		(0.118) x 45°	
Ø R	3.1	3.4	0.122	0.134

X025b GUPF

Weight = 8.5 g

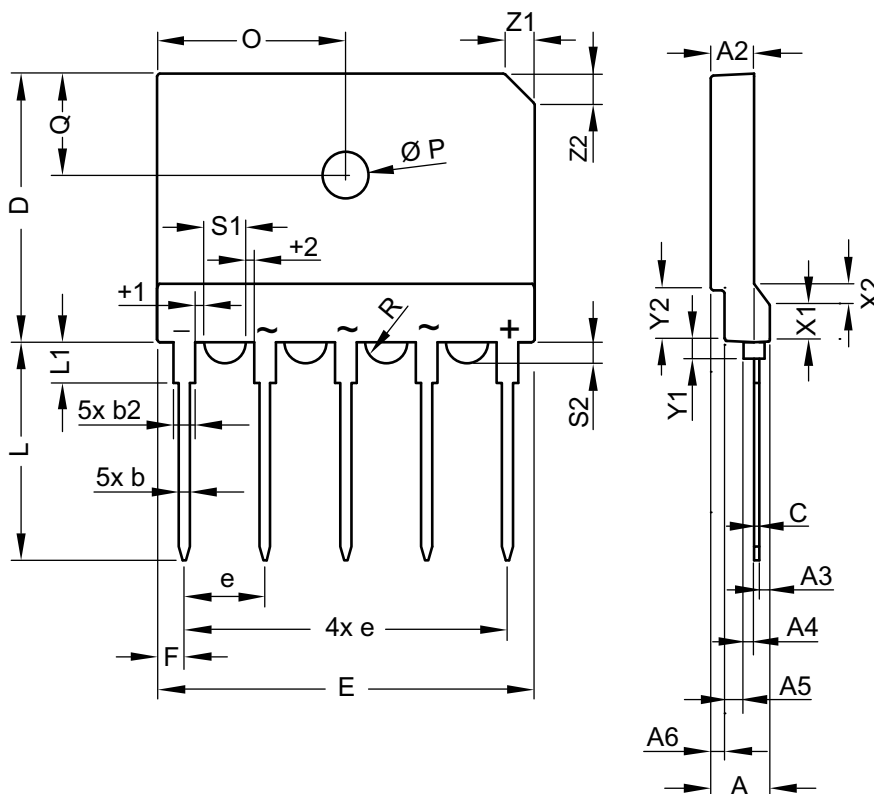

Dim.	Millimeters			Inches		
	min	typ.	max	min	typ.	max
A	5.40	5.50	5.60	0.213	0.217	0.221
A2	3.90	4.00	4.10	0.154	0.158	0.162
A3	0.95	1.00	1.10	0.037	0.039	0.043
A4	0.95	1.00	1.05	0.037	0.039	0.041
A5	1.60	1.70	1.80	0.063	0.067	0.071
A6	1.25	1.30	1.35	0.049	0.051	0.053
b	0.95	1.00	1.05	0.037	0.039	0.041
b2	1.95	2.00	2.05	0.077	0.079	0.081
C	0.45	0.50	0.55	0.018	0.020	0.022
D	24.80	25.00	25.20	0.977	0.985	0.993
E	34.70	35.00	35.30	1.367	1.379	1.391
e	BSC 7.50		BSC 0.296			
F	2.40	2.50	2.60	0.095	0.099	0.102
L	2.30	20.40	2.50	0.091	0.804	0.099
L1	3.70	3.75	3.80	0.146	0.148	0.150
O	17.40	17.50	17.60	0.686	0.690	0.693
Ø P	4.10	4.20	4.30	0.162	0.165	0.169
Q	9.20	9.30	9.40	0.362	0.366	0.370
½ R	-	1.77	-	-	0.070	-
s1	3.45	3.50	3.55	0.136	0.138	0.140
s2	1.45	1.50	1.55	0.057	0.059	0.061
t1	0.95	1.00	1.05	0.037	0.039	0.041
t2	0.95	1.00	1.05	0.037	0.039	0.041
x1	3.20	3.30	3.40	0.126	0.130	0.134
x2	1.90	2.00	2.10	0.075	0.079	0.083
y1	1.60	1.65	1.70	0.063	0.065	0.067
y2	4.65	4.70	4.75	0.183	0.185	0.187
z1	2.80	2.90	3.00	0.110	0.114	0.118

Dimensions in mm and inches (1 mm = 0.0394")

X026c ISOPLUS™-DIL (SMD) Weight = 13 g

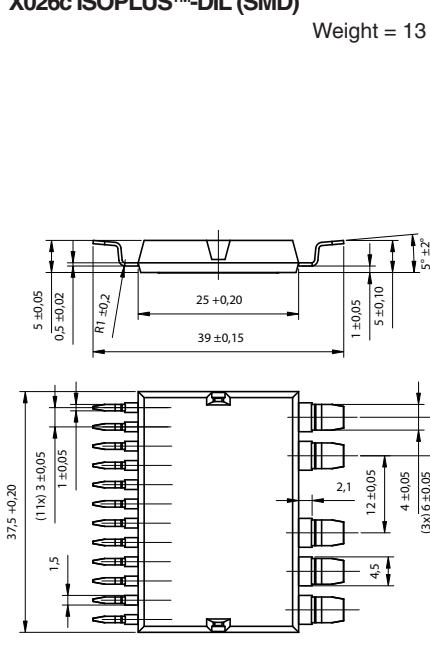

Technical drawing showing side and top views of the X026c ISOPLUS™-DIL (SMD) component. Dimensions include: 5 ±0.05, 0.5 ±0.02, R1 ±0.2, 25 ±0.20, 39 ±0.15, 1 ±0.05, 5 ±0.10, 5° ±2', 37.5 ±0.20, 1 ±0.05, 1.5, 2.1, 12 ±0.05, 4 ±0.05, (3X) 6 ±0.05.

X026d ISOPLUS™-DIL (SMD) Weight = 13 g

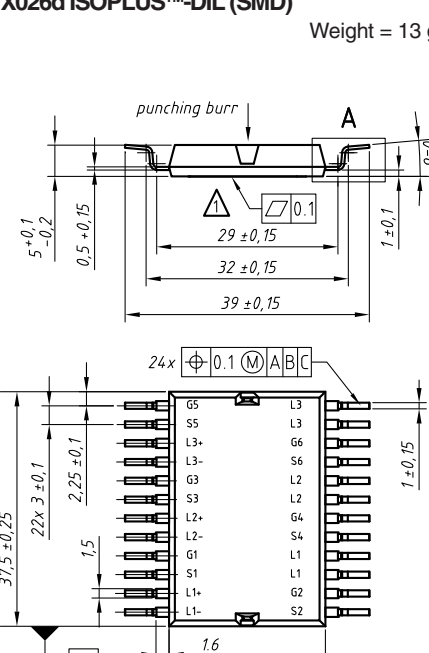

Technical drawing showing side and top views of the X026d ISOPLUS™-DIL (SMD) component. Dimensions include: 5 ±0.1, 0.5 ±0.15, 29 ±0.15, 32 ±0.15, 39 ±0.15, 1 ±0.1, 6.8 ±0, 37.5 ±0.25, 22x 3 ±0.1, 2.25 ±0.1, 1.5, 1.6, 25 ±0.25, 1 ±0.15, 3.5 ±0.02, 3.55 ±0.02 / -0.15. Detail A shows a SEATING PLANE.

X027a SOT-227 B miniBLOC Weight = 29 g
X027b SOT-227 UI miniBLOC

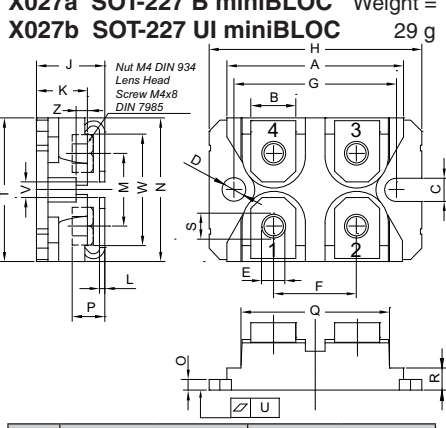

Technical drawing showing side and top views of the X027a and X027b miniBLOC components. Dimensions include: J, K, Z, H, A, G, B, 4, 3, 2, D, E, F, L, M, N, P, Q, R, U, V, W, X, Y, Z.

Dim.	Millimeters		Inches	
	min	max	min	max
A	31.50	31.88	1.240	1.255
B	7.80	8.20	0.307	0.323
C	4.09	4.29	0.161	0.169
D	4.09	4.29	0.161	0.169
E	4.09	4.29	0.161	0.169
F	14.91	15.11	0.587	0.595
G	30.12	30.30	1.186	1.193
H	37.80	38.23	1.488	1.505
J	11.68	12.22	0.460	0.481
K	8.92	9.60	0.351	0.378
L	0.74	0.84	0.029	0.033
M	12.50	13.10	0.492	0.516
N	25.15	25.42	0.990	1.001
O	1.95	2.13	0.077	0.084
P	4.95	6.20	0.195	0.244
Q	26.54	26.90	1.045	1.059
R	3.94	4.42	0.155	0.174
S	4.55	4.85	0.179	0.191
T	24.59	25.25	0.968	0.994
U	-0.05	0.10	-0.002	0.004
V	3.20	5.50	0.126	0.217
W	19.81	21.08	0.780	0.830
Z	2.50	2.70	0.098	0.106

X028 ISOPLUS227™ Weight = 19 g

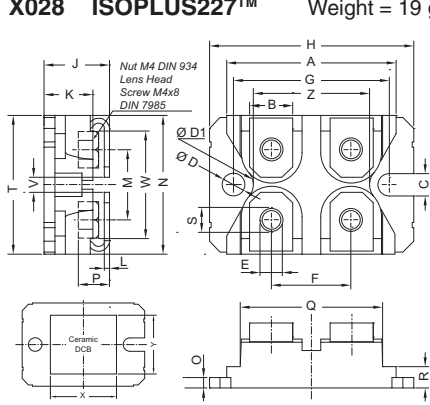

Technical drawing showing side and top views of the X028 ISOPLUS227™ component. Dimensions include: J, K, H, A, G, B, Z, D1, ØD, ØD, T, V, W, X, Y, Z, P, L, M, N, O, Q, R.

Dim.	Millimeter		Inches	
	min	max	min	max
A	31.50	32.26	1.240	1.270
B	7.87	8.38	0.310	0.330
C	3.94	4.19	0.155	0.165
D	3.94	4.19	0.155	0.165
D1	3.81	3.98	0.150	0.157
E	4.06	4.27	0.160	0.168
F	14.91	15.11	0.587	0.595
G	30.12	30.30	1.186	1.193
H	37.80	38.23	1.489	1.505
J	11.81	12.22	0.465	0.481
K	9.40	9.65	0.370	0.380
L	0.76	0.84	0.030	0.033
M	12.60	12.85	0.496	0.506
N	25.15	25.42	0.990	1.001
O	2.54	2.64	0.100	0.105
P	4.95	5.97	0.195	0.235
Q	26.54	26.90	1.045	1.059
R	4.06	4.32	0.160	0.170
S	4.72	4.85	0.186	0.191
T	24.59	25.07	0.968	0.987
U	-0.03	0.05	-0.001	0.002
V	3.30	4.06	0.130	0.160
W	19.81	21.08	0.780	0.830
X	19.56	20.57	0.770	0.810
Y	17.27	18.29	0.680	0.720
Z	22.48	22.66	0.885	0.892

X030a SMPD-B Weight = 8.5 g

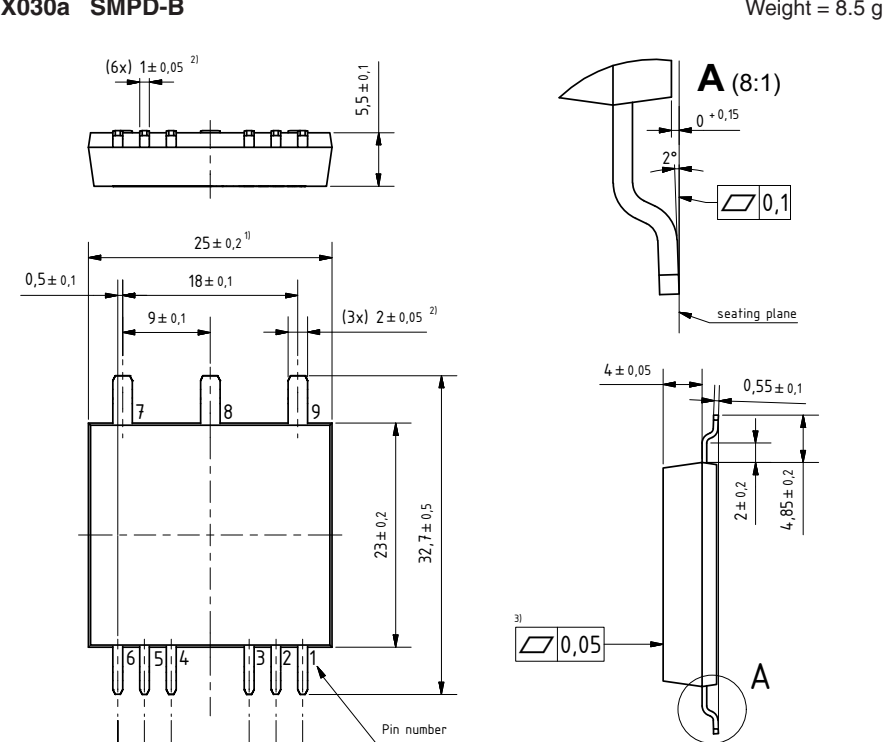

Technical drawing showing side and top views of the X030a SMPD-B component. Dimensions include: (6x) 1 ±0.05²⁾, 5.5 ±0.1, 25 ±0.2¹⁾, 18 ±0.1, 9 ±0.1, (3x) 2 ±0.05²⁾, 23 ±0.2, 32.7 ±0.5, 7, 8, 9, 2.75 ±0.1, 5.5 ±0.1, 13.5 ±0.1, 16.25 ±0.1, 19 ±0.1, 4 ±0.05, 0.55 ±0.1, 2 ±0.2, 4.65 ±0.2, 0 ±0.15, 2°, 0.1, seating plane, 0.05, Pin number.

Notes:

- 1) protrusion may add 0.2 mm max. on each side
- 2) additional max. 0.05 mm per side by punching misalignment or overlap of dam bar or bending compression
- 3) DCB area 10 to 50 µm convex; position of DCB area in relation to plastic rim: ±25 µm (measured 2 mm from Cu rim)
- 4) terminal plating: 2 - 6 µm Ni + 10 - 25 µm Sn (galv.) cutting edges may be partially free of plating

Dimensions in mm and inches (1 mm = 0.0394")

X031...* SMPD-X * See data sheet for pin arrangement

Weight = 8.5 g*

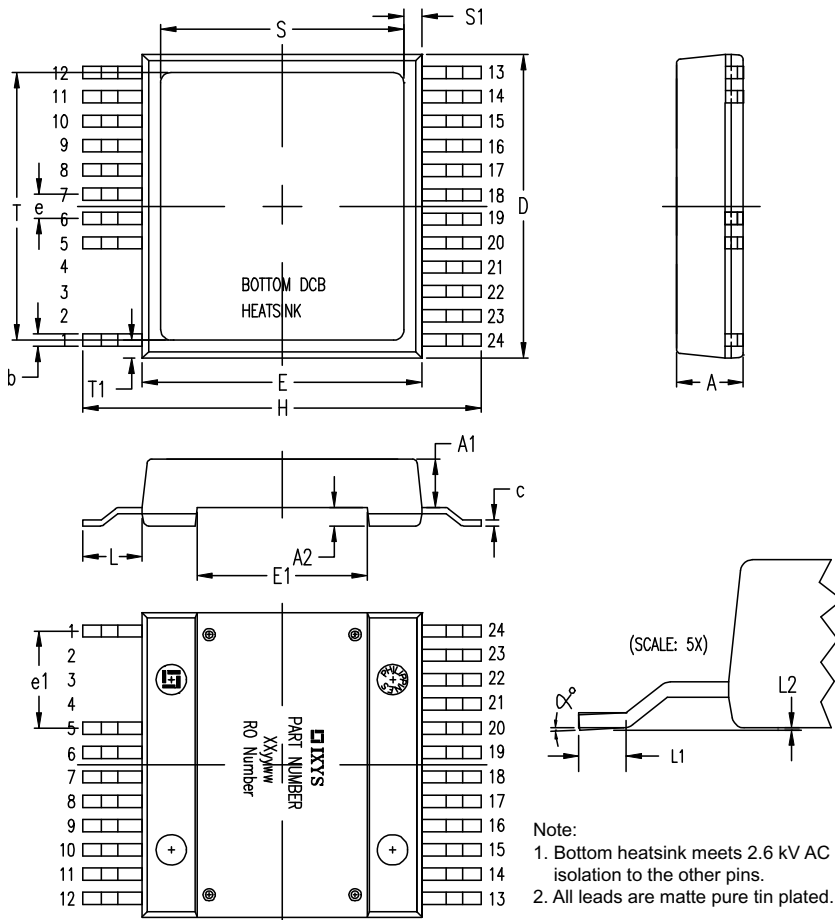

Dim.	Millimeters		Inches	
	min	max	min	max
A	5.30	5.70	0.209	0.224
A1	3.90	4.10	0.154	0.161
A2	1.40	1.60	0.055	0.063
b	0.90	1.15	0.035	0.045
c	0.45	0.65	0.018	0.026
D	24.80	25.25	0.976	0.994
E	22.80	23.25	0.898	0.915
E1	13.80	14.20	0.543	0.559
e	2.00	BSC	0.079	BSC
e1	8.00	BSC	0.315	BSC
H	32.30	33.30	1.272	1.311
L	4.60	5.30	0.181	0.209
L1	1.30	1.70	0.051	0.067
L2	0.00	0.15	0.000	0.006
S	18.85	20.12	0.742	0.792
S1	1.45	2.08	0.057	0.082
T	20.90	22.17	0.823	0.873
T1	1.42	2.03	0.056	0.080
a	4°	-	4°	-

Note:
1. Bottom heatsink meets 2.6 kV AC isolation to the other pins.
2. All leads are matte pure tin plated.

X032... MiniSMPD * See data sheet for pin arrangement

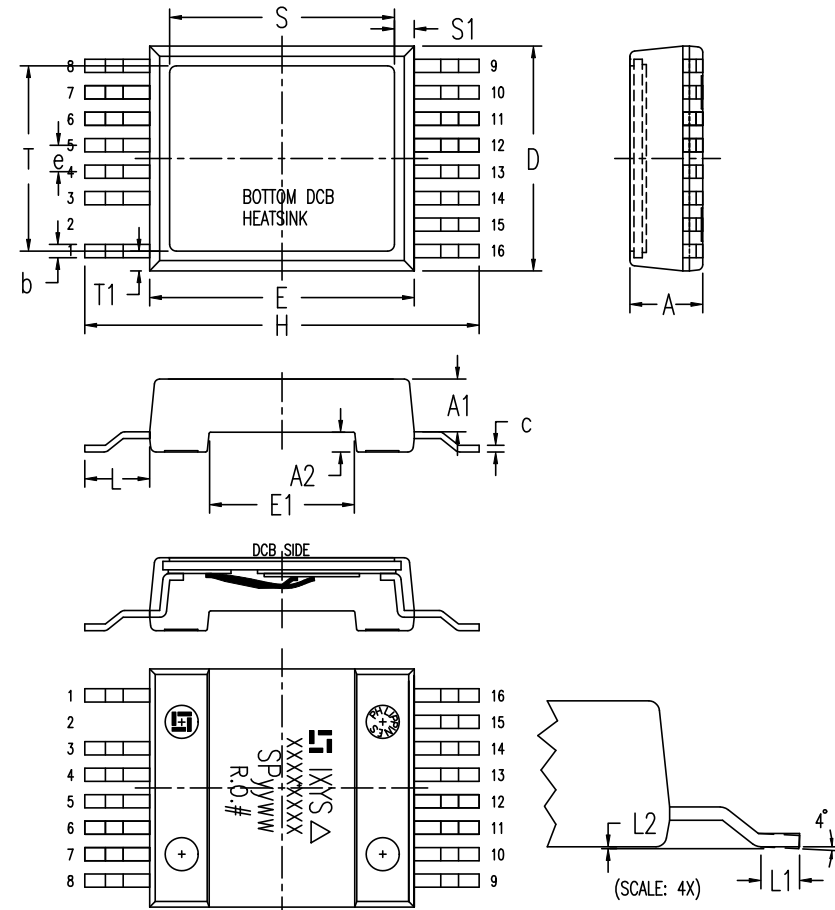

Dim.	Millimeters		Inches	
	min	max	min	max
A	5.30	5.70	0.209	0.224
A1	3.90	4.10	0.154	0.161
A2	1.40	1.60	0.055	0.063
b	0.90	1.15	0.035	0.045
c	0.45	0.65	0.018	0.026
D	16.80	17.20	0.661	0.677
E	19.80	20.20	0.780	0.795
E1	10.80	11.20	0.425	0.441
e	2.00 BSC		0.079 BSC	
H	29.50	30.10	1.161	1.185
L	4.60	5.30	0.181	0.209
L1	1.30	1.70	0.051	0.067
L2	0.00	0.15	0.000	0.006
S	16.80	17.20	0.661	0.677
S1	1.30	1.70	0.051	0.067
T	13.80	14.20	0.543	0.559
T1	1.30	1.70	0.051	0.067

NOTE:
1. All leads are matte pure tin plated.
2. Cu surface of bottom DCB is pre-Ni plated unless otherwise.
3. Cu surface of bottom DCB is electrically isolated 2.500V AC from all other leads.
4. Unless other specified, pin out are as follows:
Pin #1 - Gate
Pin #3 - Gate return or source
Pin #4 through #8 - Source (emitter)
Pin #9 through #16 - Drain (collector)

Dimensions in mm and inches (1 mm = 0.0394")

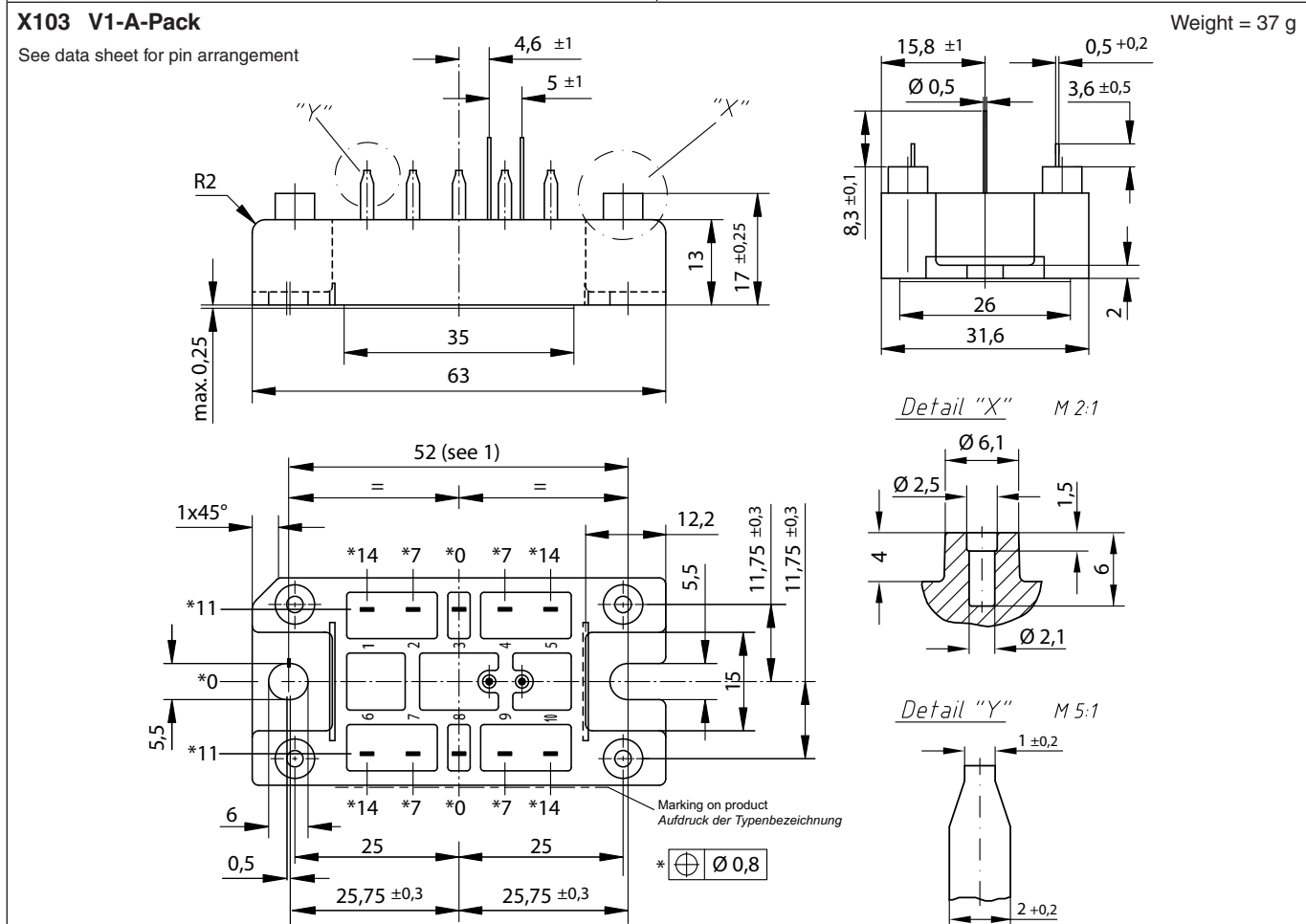
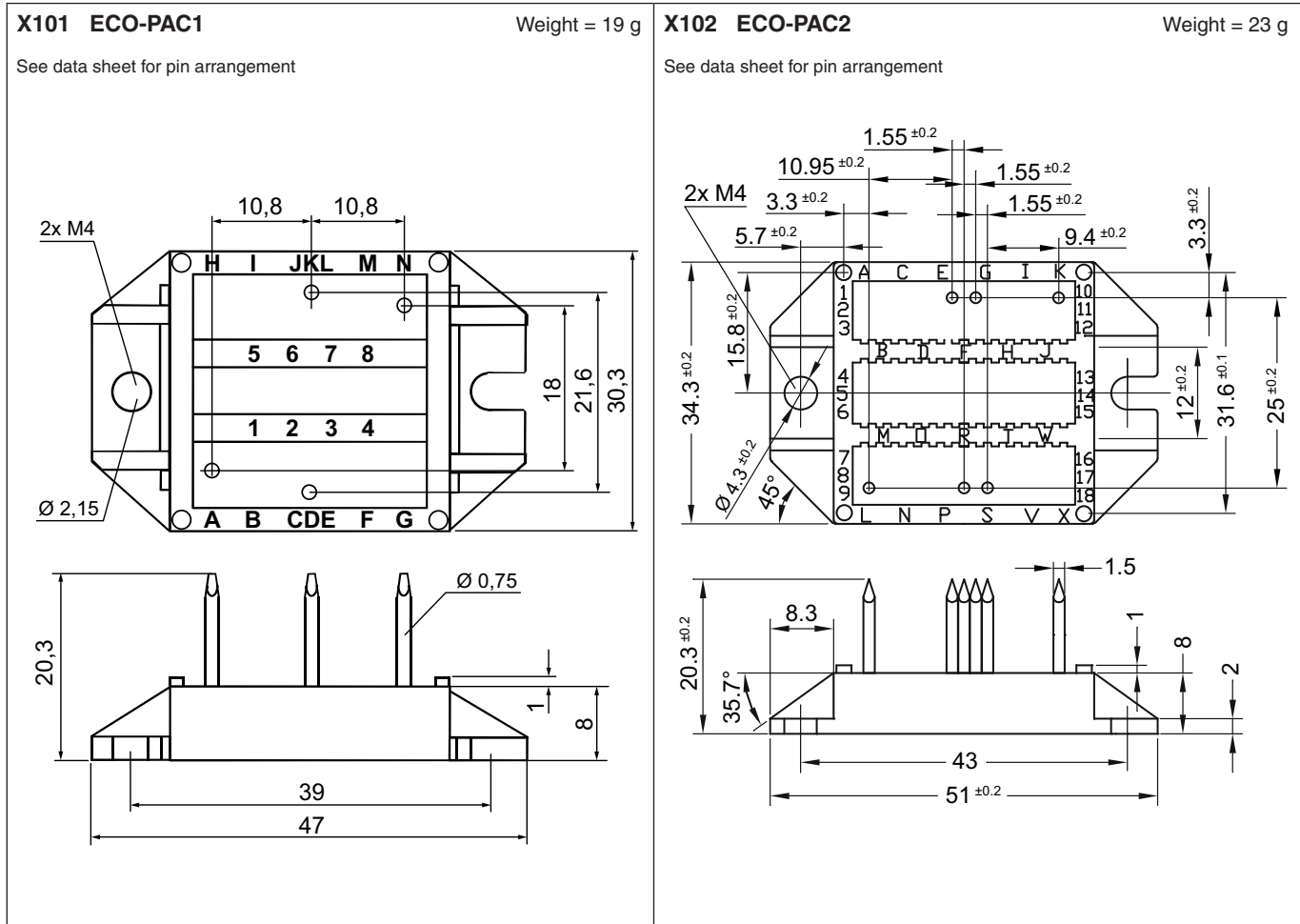

Dimensions in mm and inches (1 mm = 0.0394")

X104 V2-Pack

See data sheet for pin arrangement

Weight = 76 g

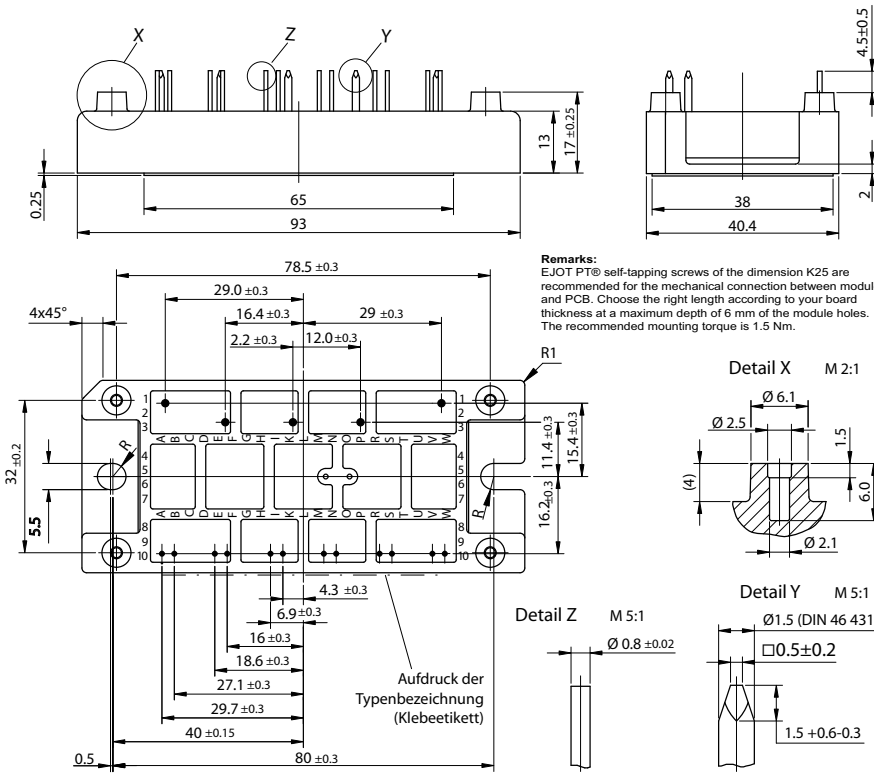

X105 V1-B-Pack

a: pin length = 31 mm
b: pin length = 16 mm

Weight = 30 g
28 g

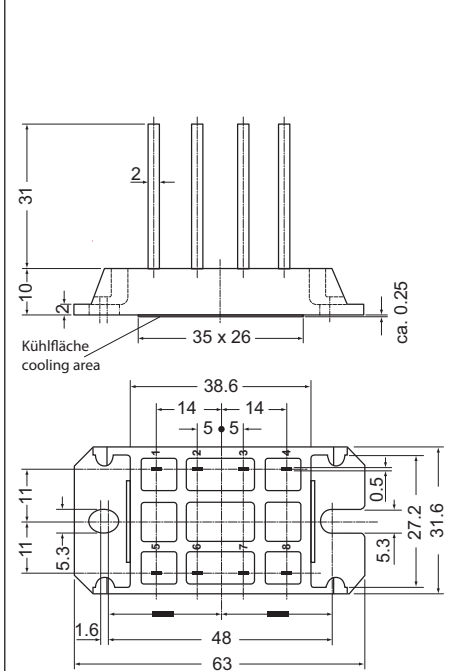

X109 Mini-Pack2B

See data sheet for pin arrangement

Weight = 42 g

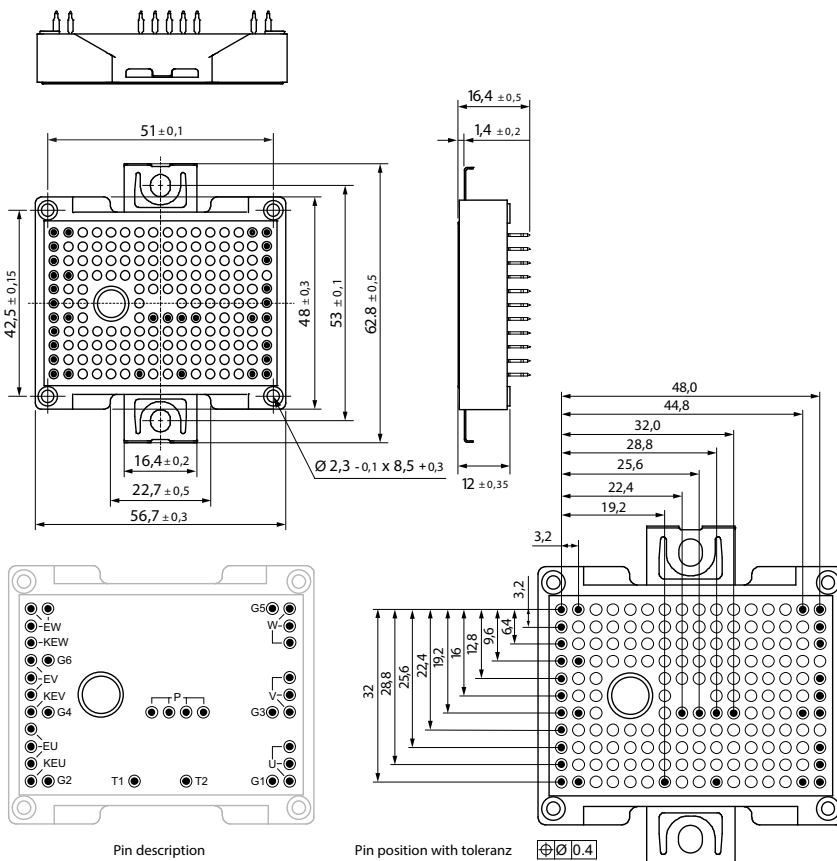

X105c V1-B-Pack

Weight = 25 g

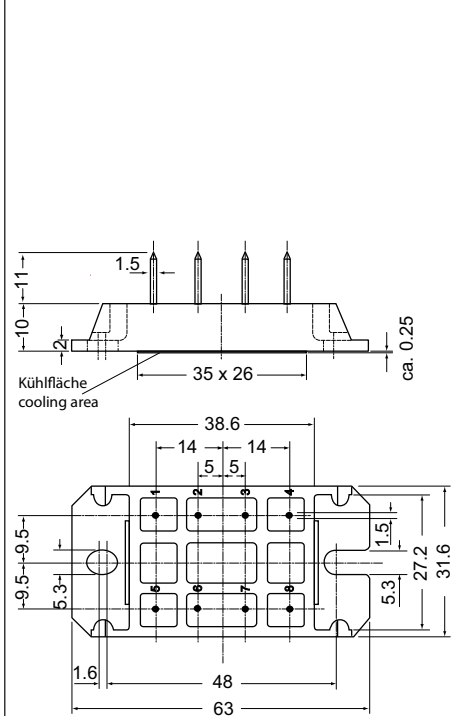

Dimensions in mm and inches (1 mm = 0.0394")

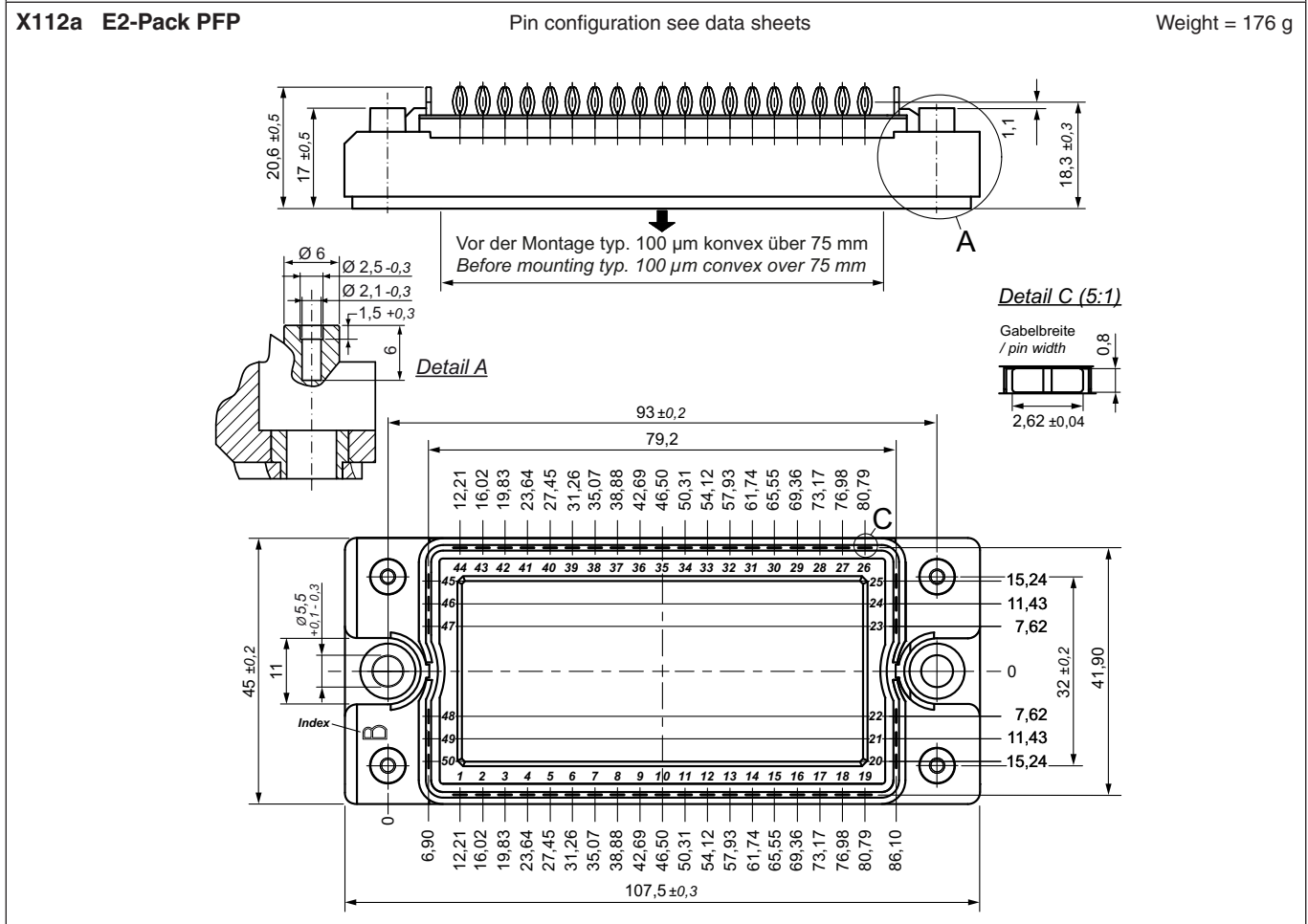
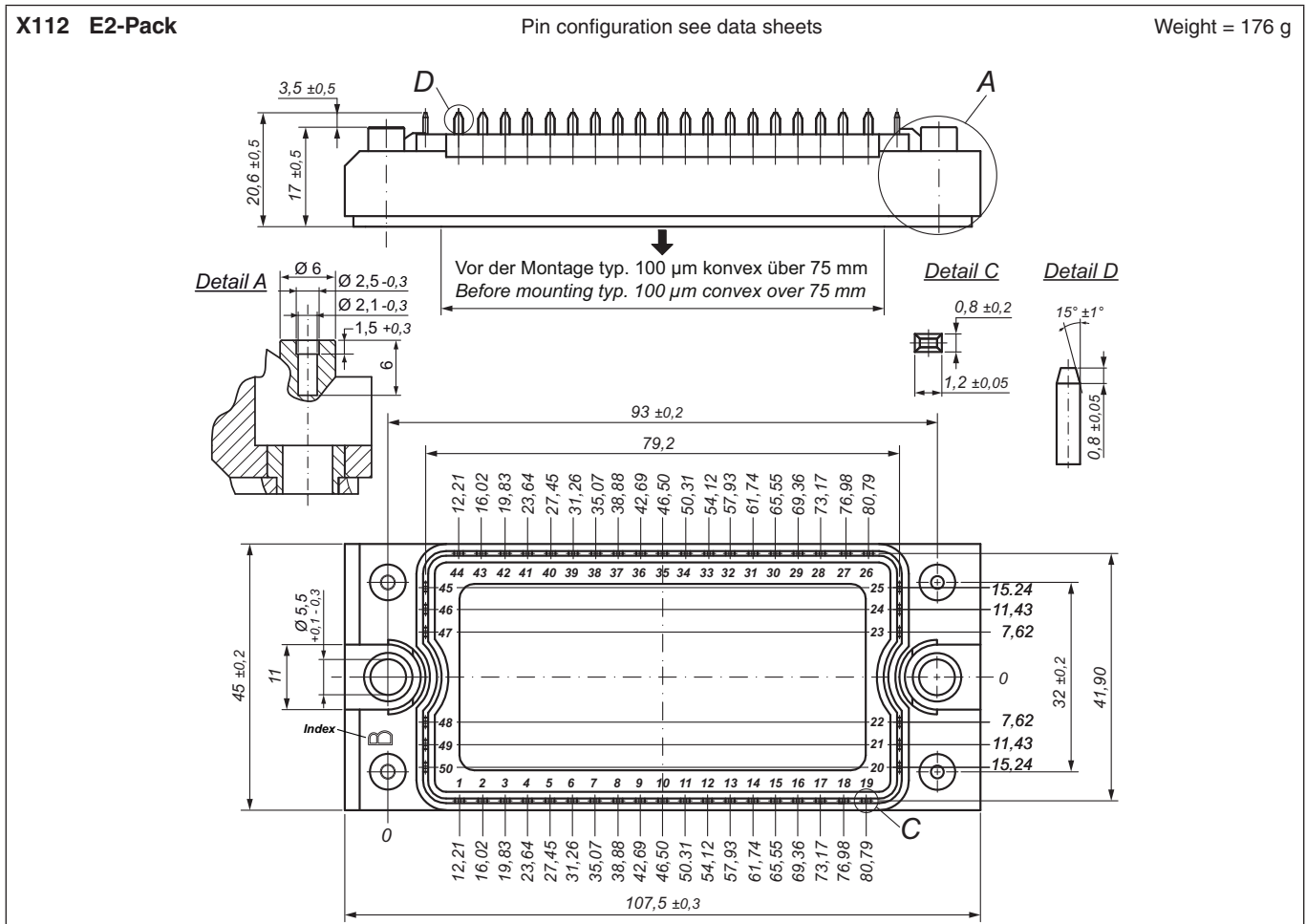

Dimensions in mm and inches (1 mm = 0.0394")

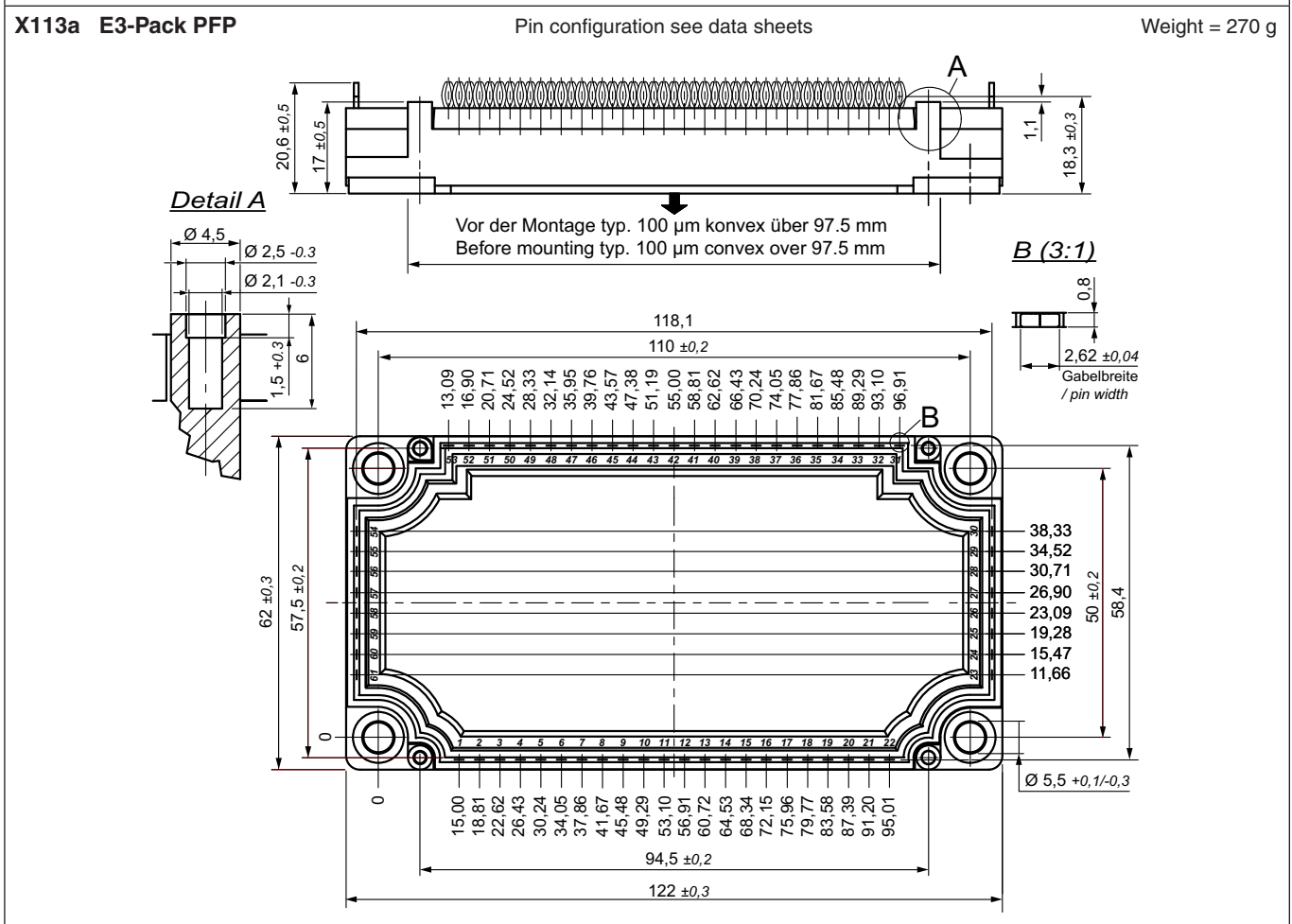
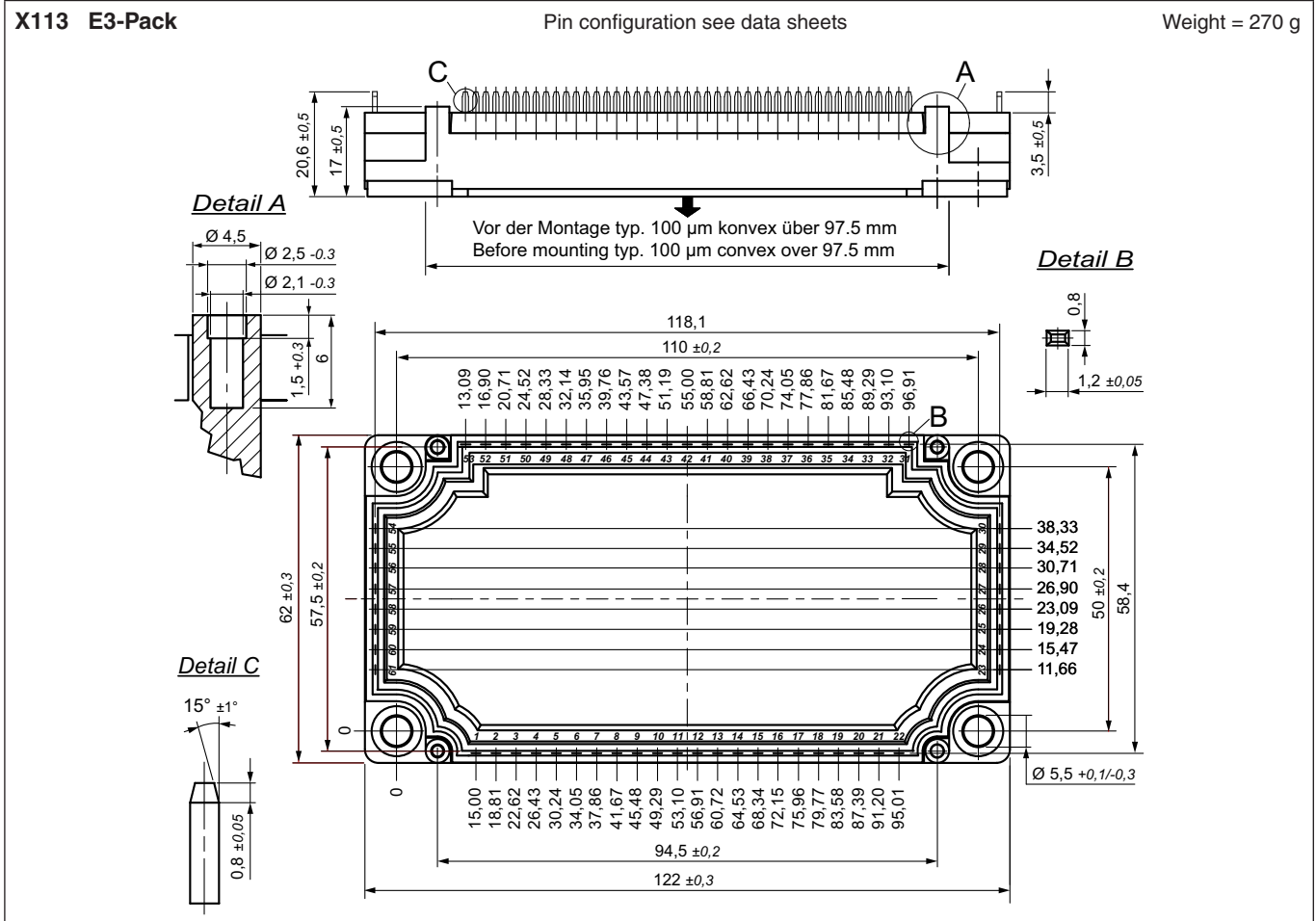

Dimensions in mm and inches (1 mm = 0.0394")

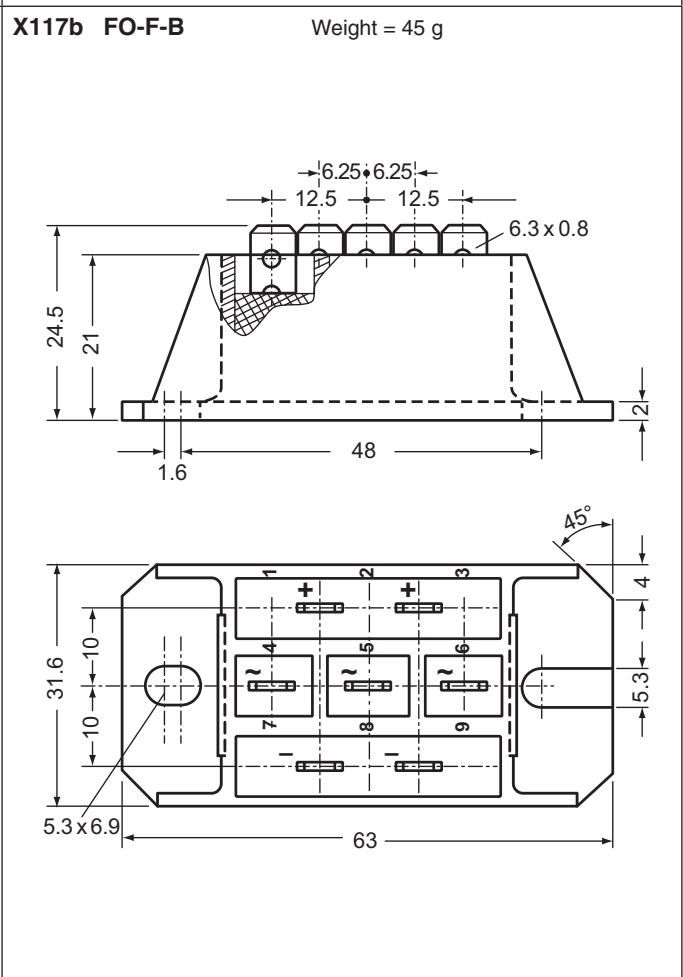
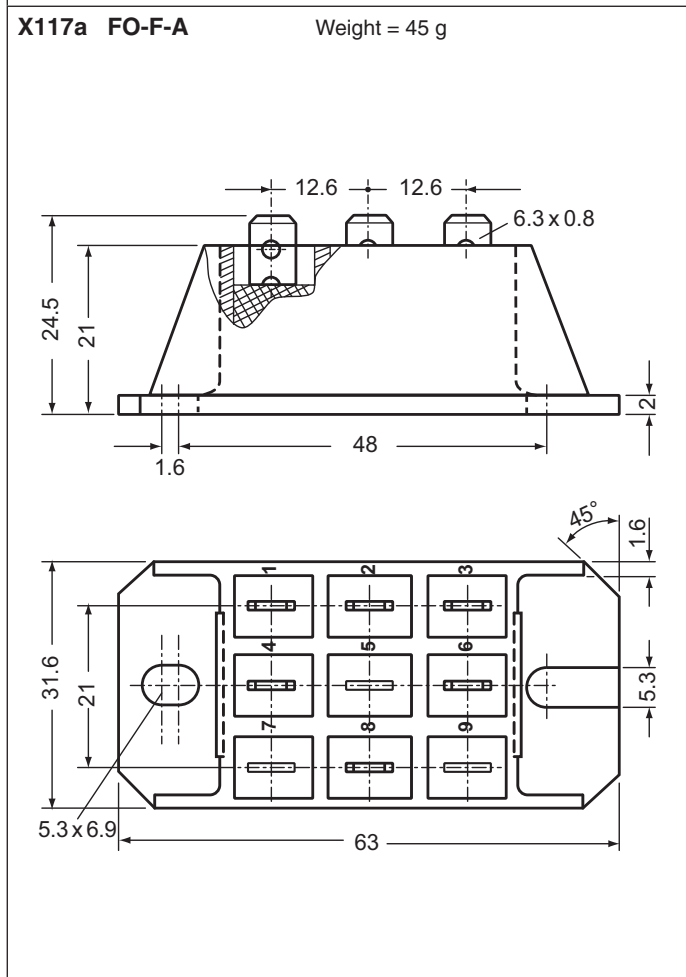
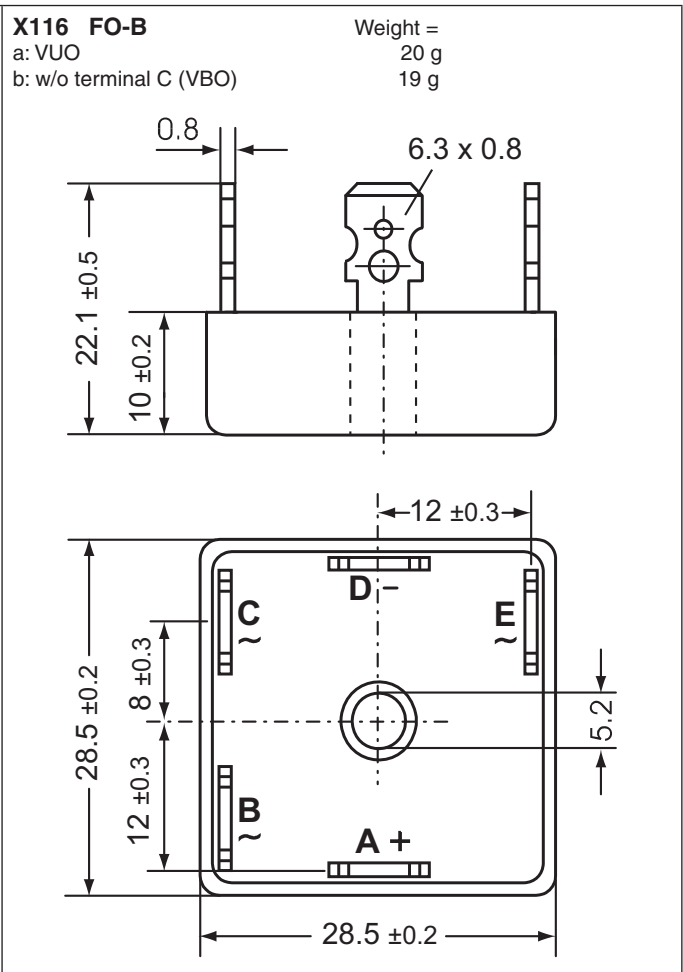
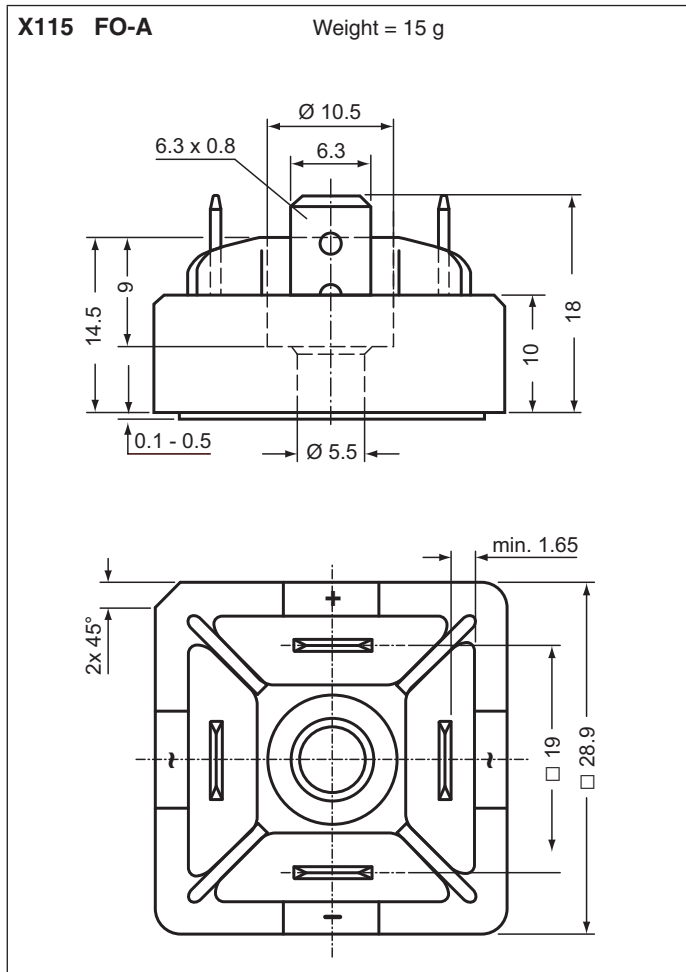

Dimensions in mm and inches (1 mm = 0.0394")

X118 FO-T-A

Weight = 104 g

c: w/o terminal 4, 5, & 6 (VVZ & VVZF)
d: w/o terminal 1, 2, 3, 4, 5, & 6 (VUO)

See data sheet for pin arrangement

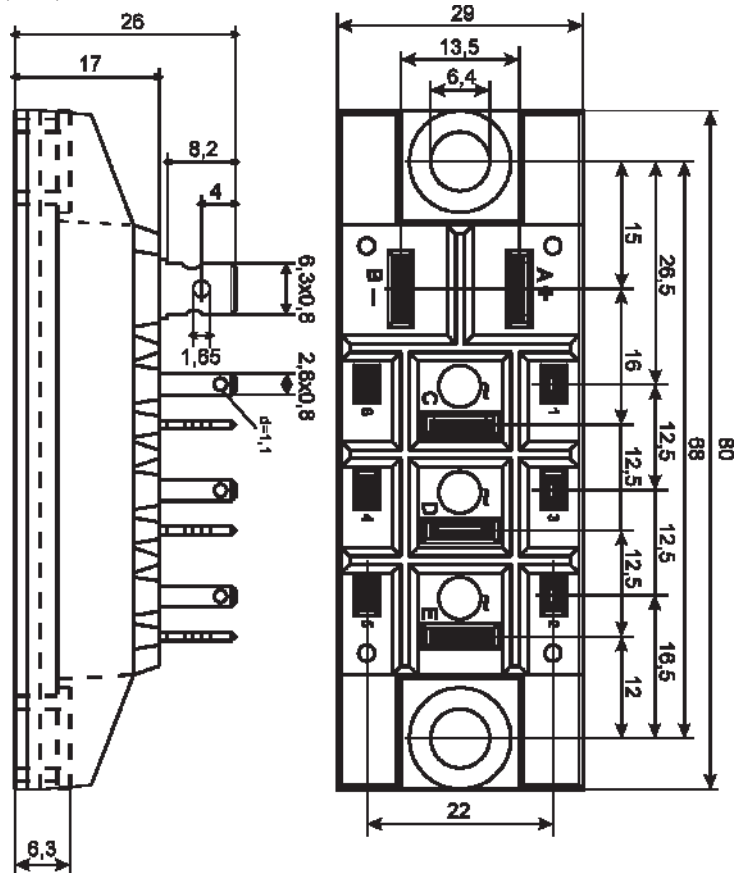

X119 PWS-A

Weight = 104 g
a: VUO
b: w/o terminal D (VBO)

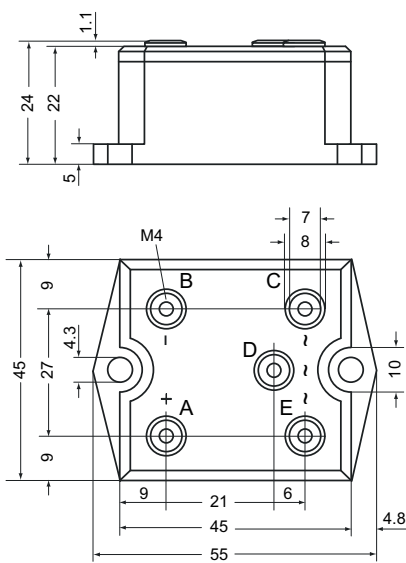

X120 PWS-B

Weight = 203 g
a: VUO
b: w/o terminal D (VBO)

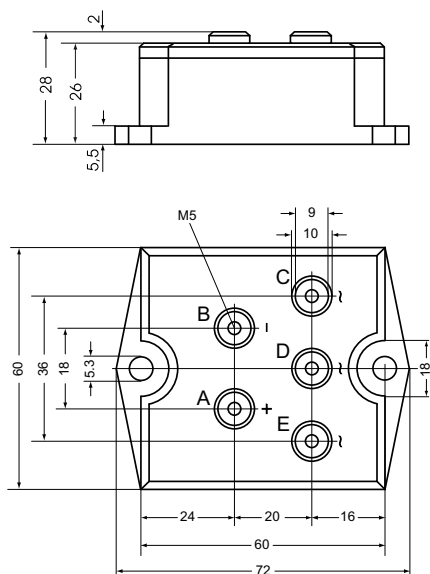

X121 PWS-C

Weight = 250 g
a: VUO
b: w/o terminal D (VBO)

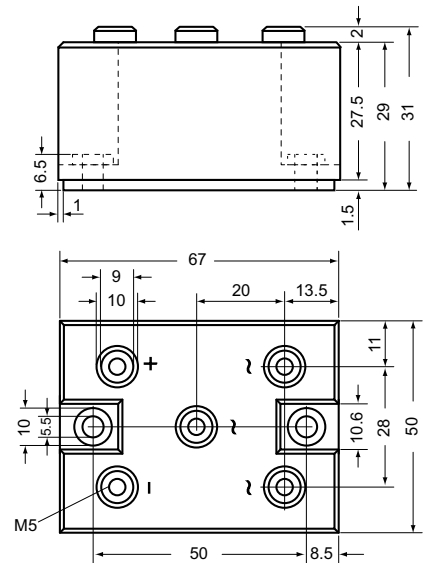

Dimensions in mm and inches (1 mm = 0.0394")

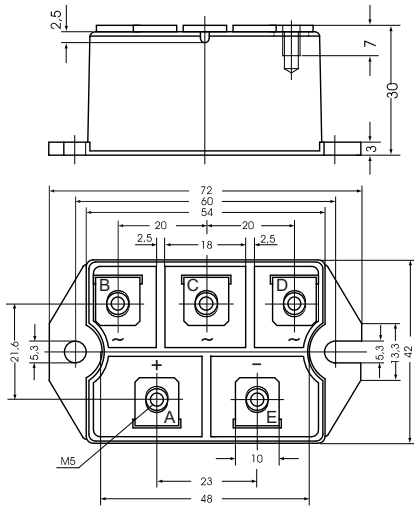
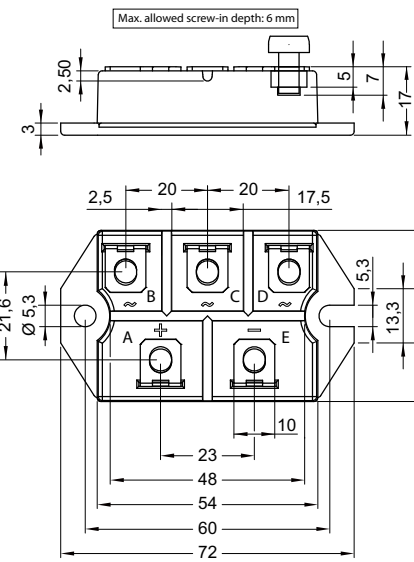
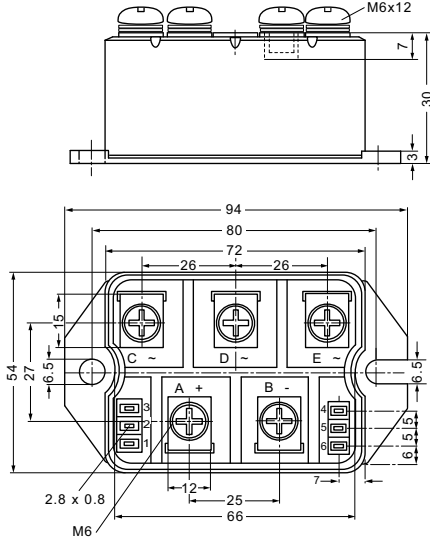
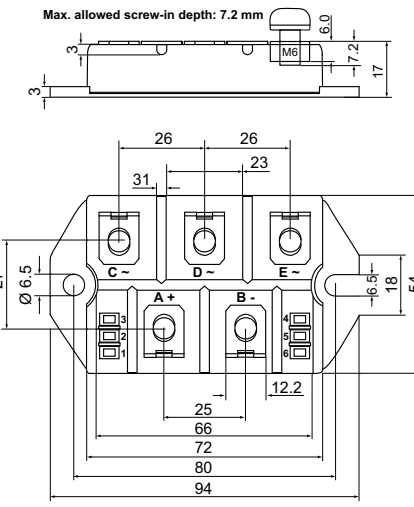
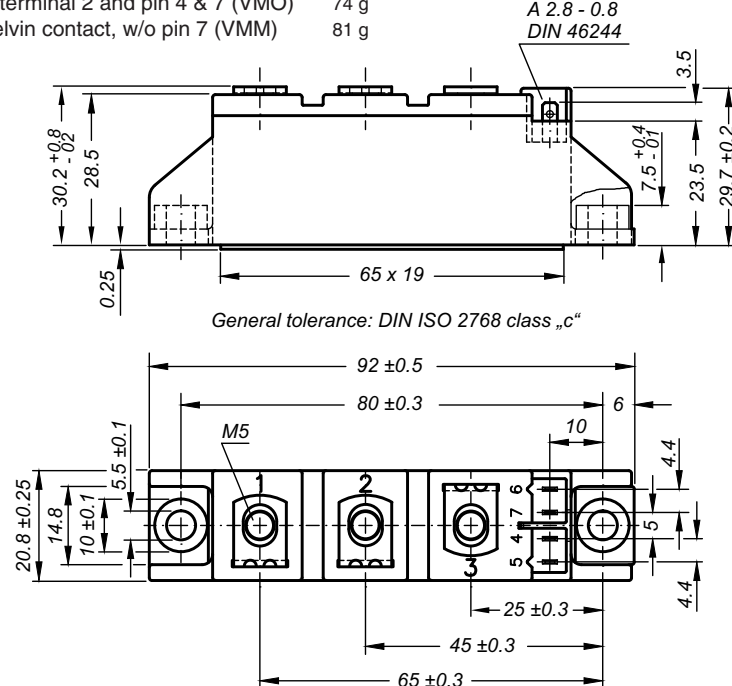
<p>X122 PWS-D Weight = a: VUO 159 g b: w/o terminal C (VBO) 153 g</p> 	<p>X122 PWS-D Flat Weight = c: VUO 118 g</p> 	<p>X123 PWS-E Weight = a: VTO 284 g b: w/o terminal 4, 5 & 6 (VVZ) 284 g c: w/o terminal 1, 2, 3, 4, 5 & 6 (VUO) 284 g d: w/o terminal D, 3, 4, 5 & 6 (VHF) 273 g e: w/o terminal D, 1, 2, 3, 4, 5 & 6 (VBO) 273 g</p> 
<p>X123 PWS-E Flat Weight = 220 g h: w/o terminal 1, 2, 3, 4, 5 & 6 (VUO)</p> 	<p>X125 TO-240 AA Weight = a: + Kelvin contact (MCC) 81 g b: + Kelvin contact, w/o pin 6 & 7 (MCD) 81 g c: w/o Kelvin contact 4 & 7 (MCC) 81 g d: w/o Kelvin contact 4, 7 & pin 6 (MCD) 81 g e: w/o pin 4, 5, 6 & 7 (MDD) 81 g f: w/o terminal 2 and pin 4 & 7 (VMO) 74 g g: + Kelvin contact, w/o pin 7 (VMM) 81 g</p>  <p>General tolerance: DIN ISO 2768 class „c“</p> <p>Optional accessories for modules Keyed gate/cathode twin plugs with wire length = 350 mm, gate = white, cathode = red Type ZY 200L (L = Left for pin pair 4/5) Type ZY 200R (R = Right for pin pair 6/7) } UL 758, style 3751</p>	

Dimensions in mm and inches (1 mm = 0.0394")

X126 Y4-M6 Weight =
a: + Kelvin cont., w/o pin 8 up to 11 (MCC) 131 g
b: + Kelvin cont., w/o pin 6 up to 11 (MCD) 131 g
c: w/o pin 4 up to 11 (MDD) 126 g
d: w/o terminal 2 & pin 4 up to 11 (MEO) 108 g

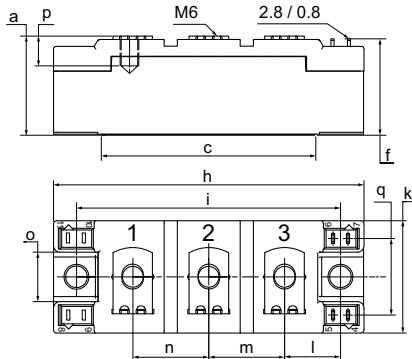

Dim.	Millimeters		Inches	
	min	max	min	max
a	30.0	30.6	1.181	1.205
c	64.0	65.0	2.520	2.559
f	28.6	29.2	1.126	1.150
h	93.5	94.5	3.681	3.720
i	79.5	80.5	3.130	3.169
j	4.8	5.2	0.189	0.205
k	33.4	34.0	1.315	1.339
l	16.7	17.3	0.657	0.681
m	22.7	23.3	0.894	0.917
n	22.7	23.3	0.894	0.917
o	14.0	15.0	0.551	0.591
p	typ. 10.5		typ. 0.413	
q	22.8	23.3	0.898	0.917

X127 Y4-M5 Weight =
a: w/o pin 8 up to 11 (MII) 110 g
b: w/o pin 6 up to 11 (MID) 108 g
c: w/o pin 4, 5 & 8 up to 11 (MDI) 108 g

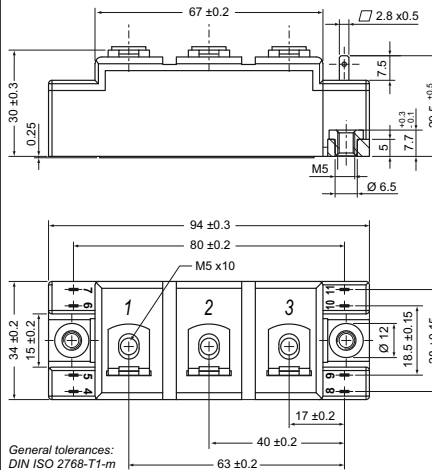

General tolerances:
DIN ISO 2768-T1-m

X127 Y4-M5-A Weight =
d: w/o pin 8 up to 11 (..PF..) 170 g
e: w/o pin 6 up to 11 (..RF..) 168 g
f: w/o pin 4, 5 & 8 up to 11 (..QF..) 166 g

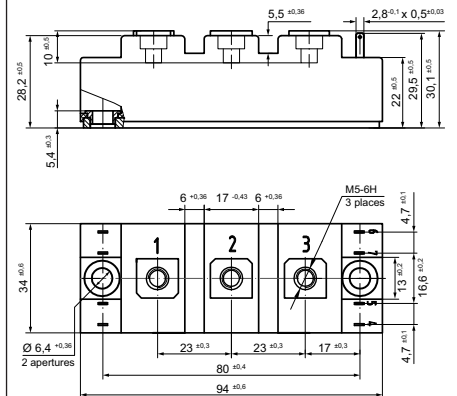

X128 Y3-DCB Weight =
a: w/o pin 4 up to 7 (VMM, MII) 222 g
b: w/o pin 4 up to 9 (MID) 220 g
c: w/o pin 4 up to 7, 10 & 11 (MDI) 220 g
d: w/o terminal 3 & pin 6 up to 11 (VMO) 200 g
e/f/g: see data sheet

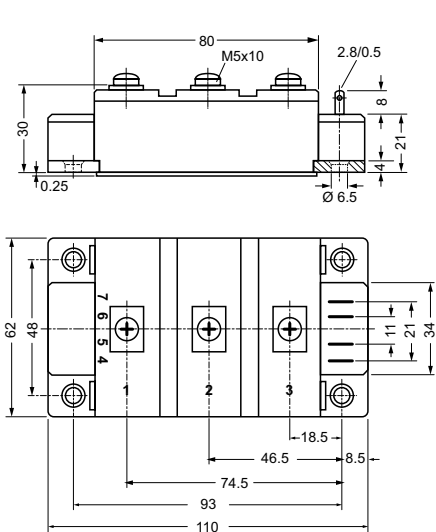

X129 Y2-DCB Weight =
a: + Kelvin contact (MCC) 245 g
b: + Kelvin contact, w/o pin 6 & 7 (MCD) 245 g
c: w/o pin 4, 5, 6 & 7 (MDD) 244 g

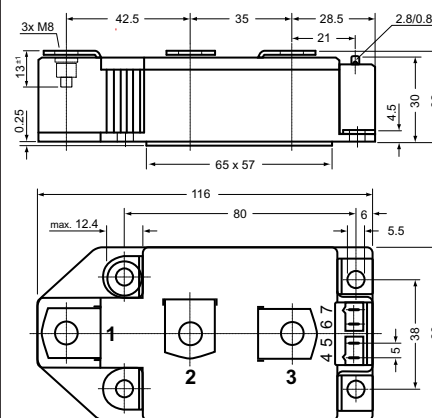

Optional accessories for modules
Keyed gate/cathode twin plugs with wire length = 350 mm, gate = white, cathode = red
Type ZY 180L (L = Left for pin pair 4/5) UL 758, style 3751
Type ZY 180R (R = Right for pin pair 6/7)

X130 Y3-Li Weight =
a: w/o pin 4-7, low inductance (VMM, MII) 226 g
b: w/o pin 4-9, low inductance (MID) 226 g
c: w/o pin 4-7, 10&11, low inductance (MDI) 226 g
d: w/o terminal 1&pin 6-11, low ind. (VMO) 206 g
e: w/o pin 4&5, low ind. (VMM, MII+NTC) 226 g
f: w/o pin 4, 5, 8 & 9, low ind. (MID+NTC) 226 g

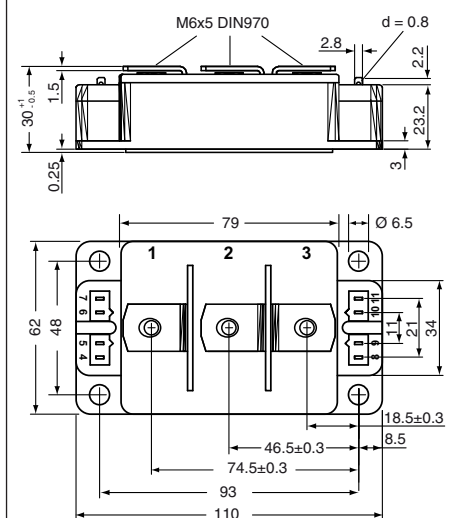

Dimensions in mm and inches (1 mm = 0.0394")

X131 Y1-CU Weight = 680 g
 a: + Kelvin contact (MCC) 680 g
 b: + Kelvin contact, w/o pin 6&7 (MCD) 680 g
 c: w/o pin 4, 5, 6 & 7 (MDD) 680 g

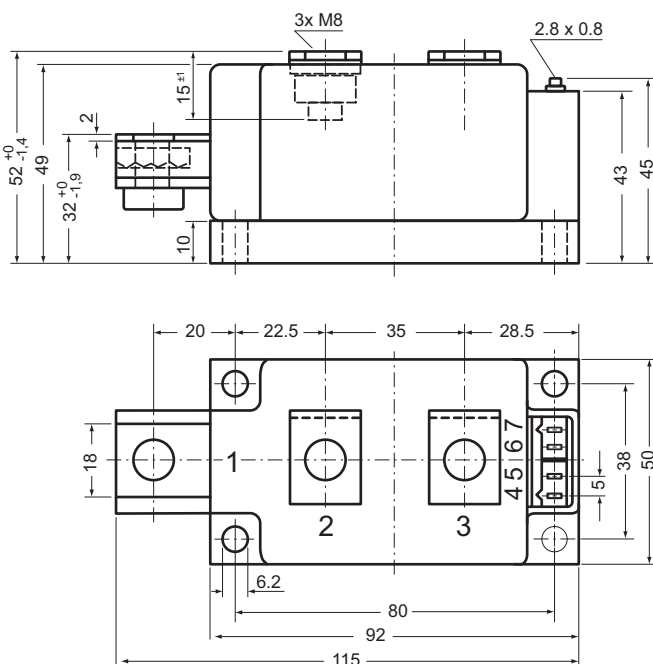

Optional accessories for modules
 Keyed gate/cathode twin plugs with wire length = 350 mm, gate = white, cathode = red
 Type ZY 180L (L = Left for pin pair 4/5) } UL 758, style 3751
 Type ZY 180R (R = Right for pin pair 6/7)

X132 Y1-2-CU Weight = 650 g
 a: + Kelvin contact w/o pin 6&7 (MCO)
 b: w/o pin 4, 5, 6 & 7 (MDO)

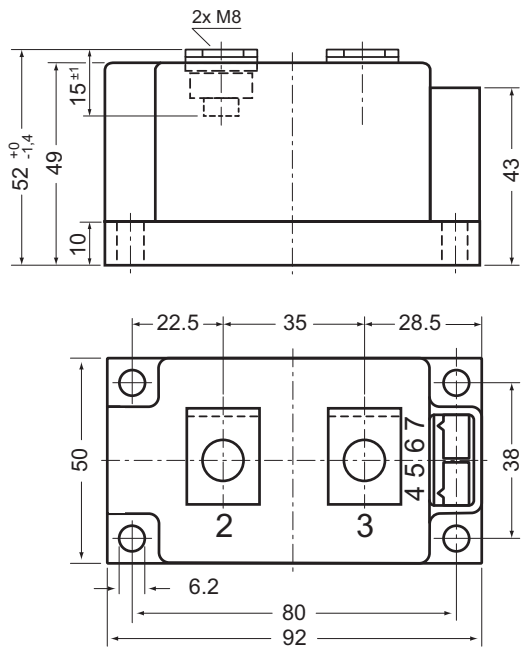

X141 SimBus A Weight = 152 g
 a: + Kelvin contact (MCC)
 b: + Kelvin contact, w/o pin 7 & 8 (MCD)
 c: w/o pin 5, 6, 7 & 8 (MDD)

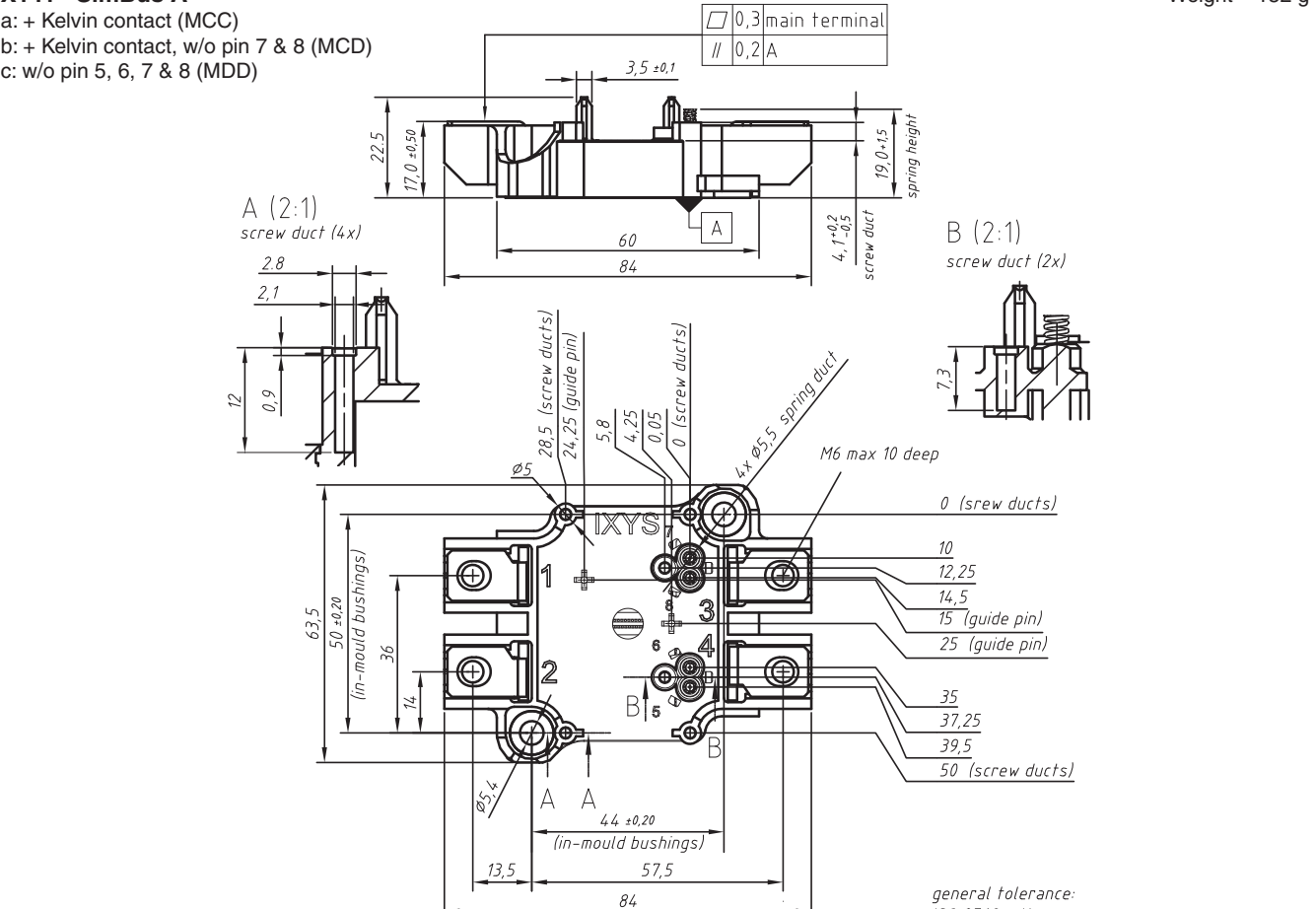

\square 0,3 main terminal
 \parallel 0,2 A

A (2:1) screw duct (4x)
 B (2:1) screw duct (2x)

0 (screw ducts)
 10
 12,25
 14,5
 15 (guide pin)
 25 (guide pin)
 35
 37,25
 39,5
 50 (screw ducts)

general tolerance:
 ISO 2768-mK

Dimensions in mm and inches (1 mm = 0.0394")

X142 ComPack

Weight = 500 g

- a: + Kelvin contact (MCC)
- b: + Kelvin contact, w/o pin 6 & 7 (MCD)
- c: w/o pin 4, 5, 6 & 7 (MDD)

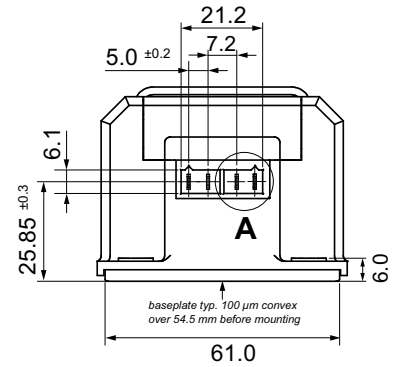
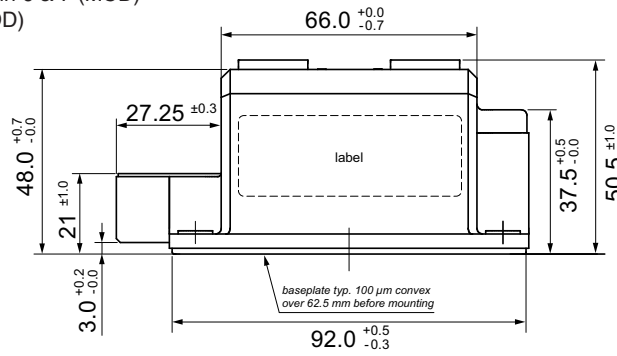

Optional accessories for modules
Keyed gate/cathode twin plugs with
wire length = 350 mm, gate = white, cathode = red
Type ZY 180L (L = Left for pin pair 4/5) } UL 758,
Type ZY 180R (R = Right for pin pair 6/7) } style 3751

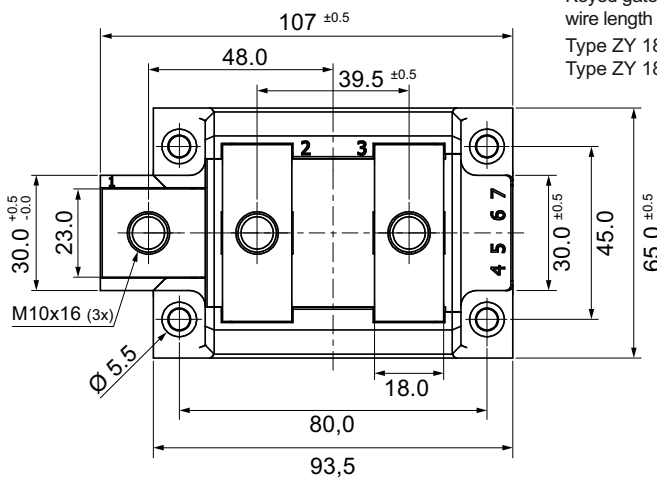

A (2:1)

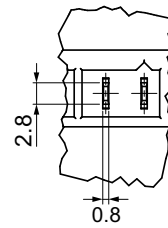

X143 SimBus F

Pin configuration see data sheets

Weight = 150 g

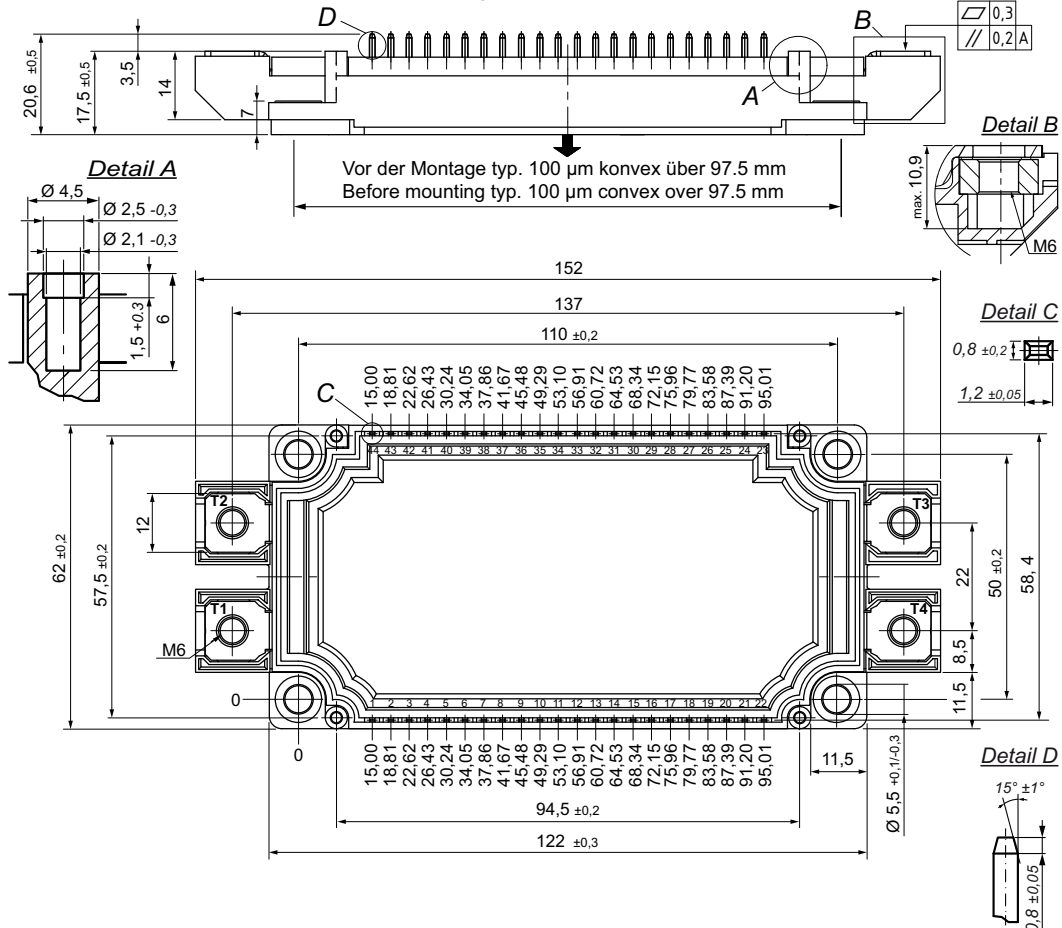

Dimensions in mm and inches (1 mm = 0.0394")

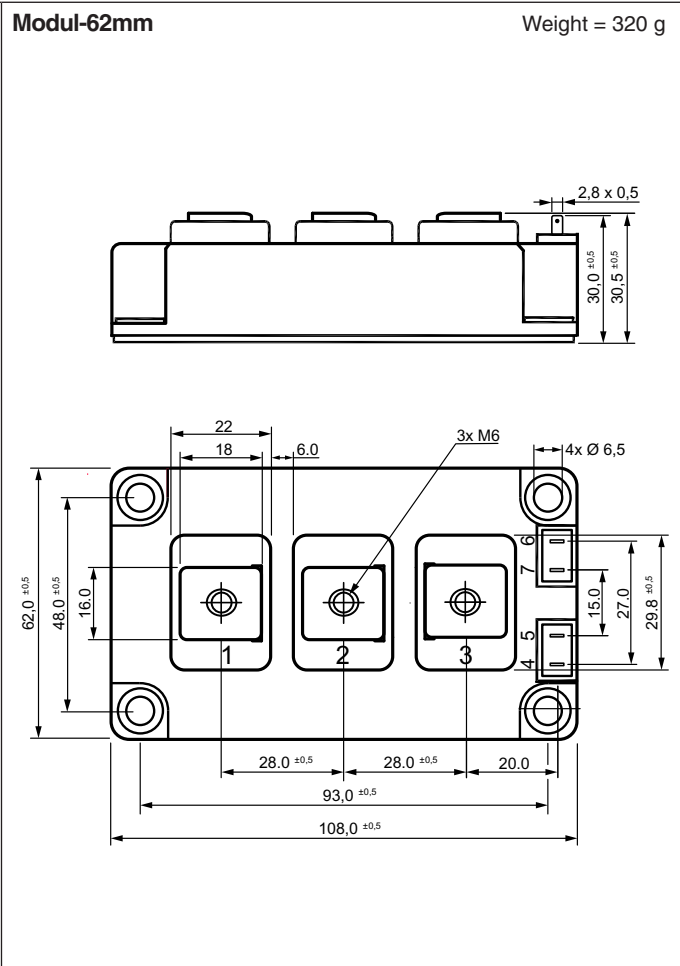
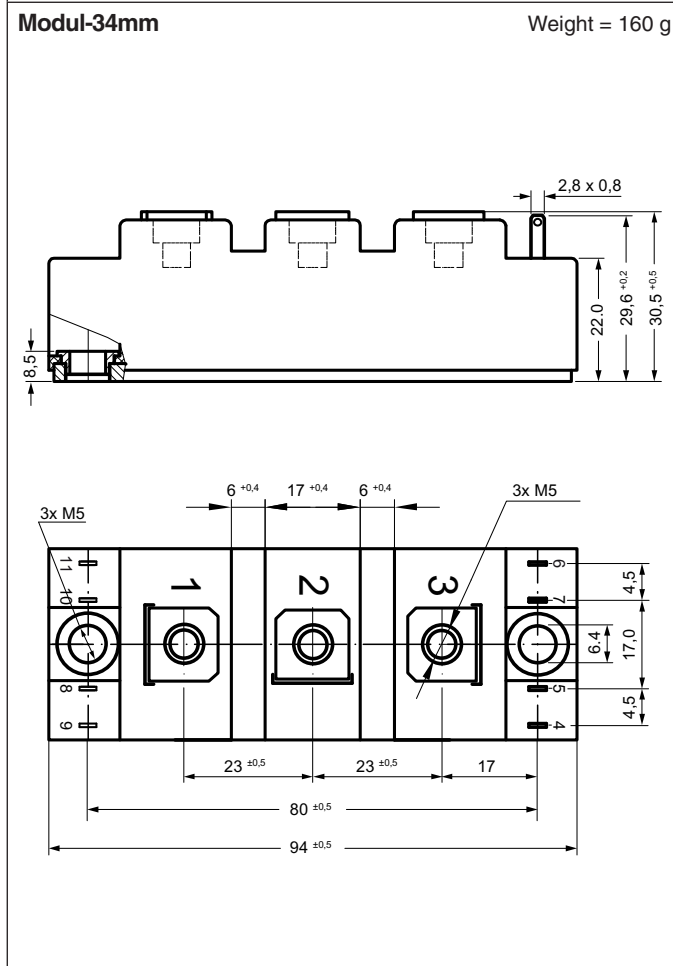
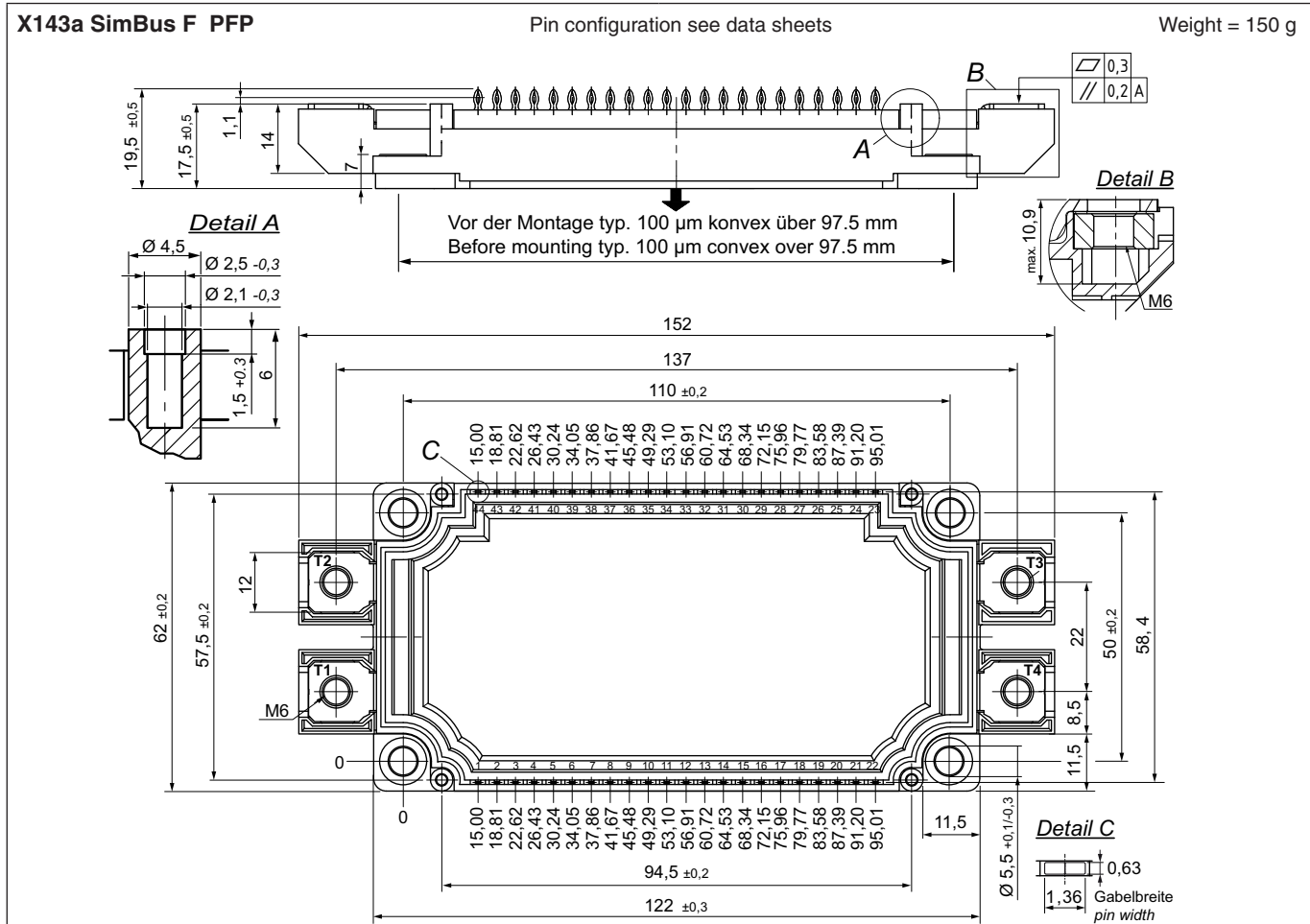

Dimensions in mm and inches (1 mm = 0.0394")

<p>X200 Metal-can Weight = 2.5 g</p>	<p>X201 FP-Case (oilproof) Weight = 0.9 g</p>	<p>X202 BOD-Package Weight = 9.5 g</p>
<p>X204 DO-203 AA [M] (DO-4) Weight = 6 g</p>	<p>X205 DO-203 AA [UNF] (DO-4) Weight = 5.5 g</p>	<p>X206a DO-203 AB [UNF] (DO-5) X206b DO-203 AB [M] (DO-5) Weight = 14 g</p>

Dimensions in mm and inches (1 mm = 0.0394")

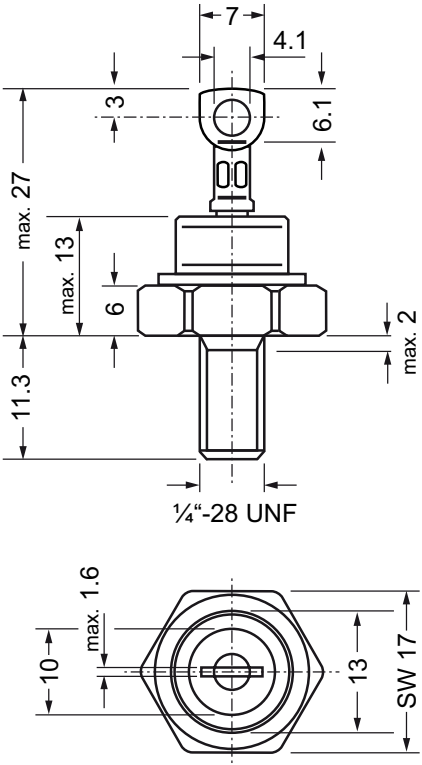
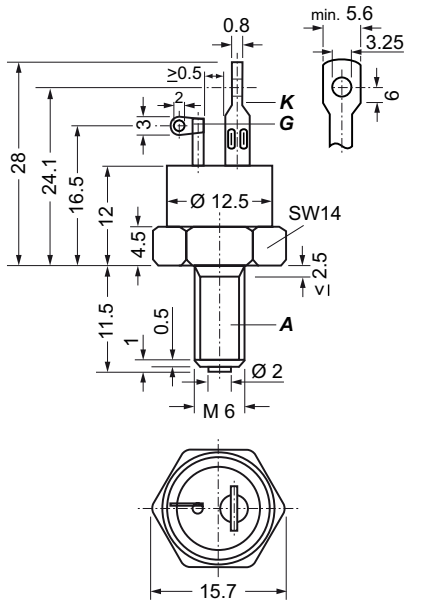
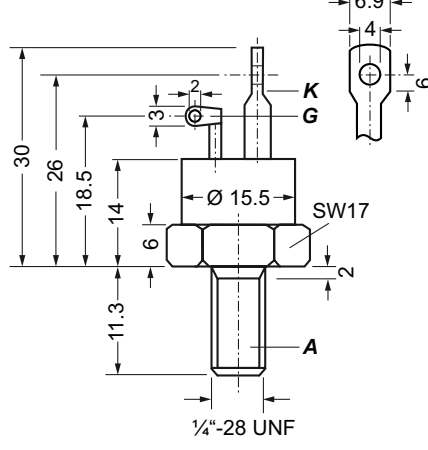
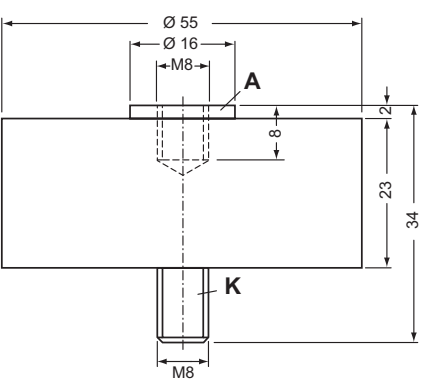
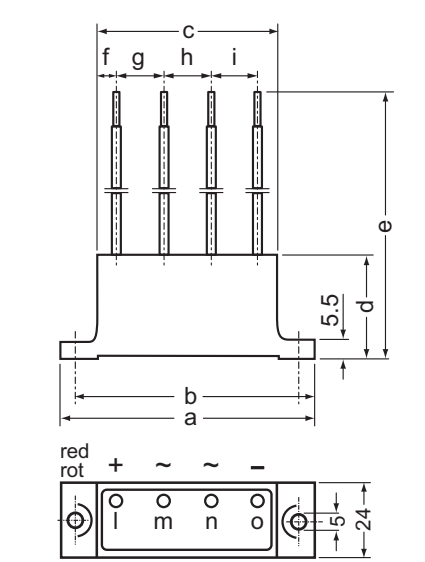
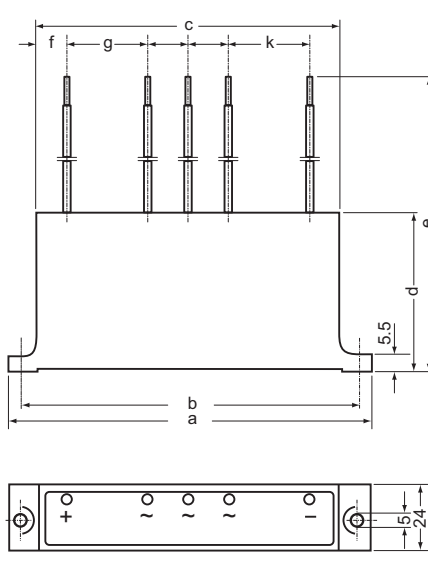
<p>X207 DO-203 AB (DO-5) Weight = 20 g</p> 	<p>X209 TO-208 AA (TO-48) Weight = 11.6 g</p> 	<p>X210 TO-208 AC (TO-65) Weight = 21.7 g</p> 																																																															
<p>X251 UGE-single Weight = 125 g</p> 	<p>X252 UG Weight = 155 g</p> 	<p>X253a UG Weight = 310 g b: w/o middle terminal</p> 																																																															
			<table border="1"> <thead> <tr> <th>Type</th> <th>a</th> <th>b</th> <th>c</th> <th>d</th> <th>e</th> <th>f</th> <th>g</th> <th>h</th> <th>i</th> <th>k</th> </tr> </thead> <tbody> <tr> <td>UGB 3132 AD</td> <td>80</td> <td>70</td> <td>57</td> <td>58.5</td> <td>260</td> <td>6</td> <td>15</td> <td>15</td> <td>15</td> <td></td> </tr> <tr> <td>UGB 6124 AG</td> <td>135</td> <td>125</td> <td>112</td> <td>58.5</td> <td>260</td> <td>11</td> <td>32.5</td> <td>25</td> <td>32.5</td> <td></td> </tr> <tr> <td>UGD 6123 AG</td> <td>135</td> <td>125</td> <td>112</td> <td>58.5</td> <td>260</td> <td>8</td> <td>30</td> <td>18</td> <td>18</td> <td>30</td> </tr> <tr> <td>UGD 8124 AG</td> <td>135</td> <td>125</td> <td>112</td> <td>58.5</td> <td>260</td> <td>8</td> <td>30</td> <td>18</td> <td>18</td> <td>30</td> </tr> </tbody> </table>								Type	a	b	c	d	e	f	g	h	i	k	UGB 3132 AD	80	70	57	58.5	260	6	15	15	15		UGB 6124 AG	135	125	112	58.5	260	11	32.5	25	32.5		UGD 6123 AG	135	125	112	58.5	260	8	30	18	18	30	UGD 8124 AG	135	125	112	58.5	260	8	30	18	18	30
Type	a	b	c	d	e	f	g	h	i	k																																																							
UGB 3132 AD	80	70	57	58.5	260	6	15	15	15																																																								
UGB 6124 AG	135	125	112	58.5	260	11	32.5	25	32.5																																																								
UGD 6123 AG	135	125	112	58.5	260	8	30	18	18	30																																																							
UGD 8124 AG	135	125	112	58.5	260	8	30	18	18	30																																																							
			Dimensions in mm																																																														

Dimensions in mm and inches (1 mm = 0.0394")

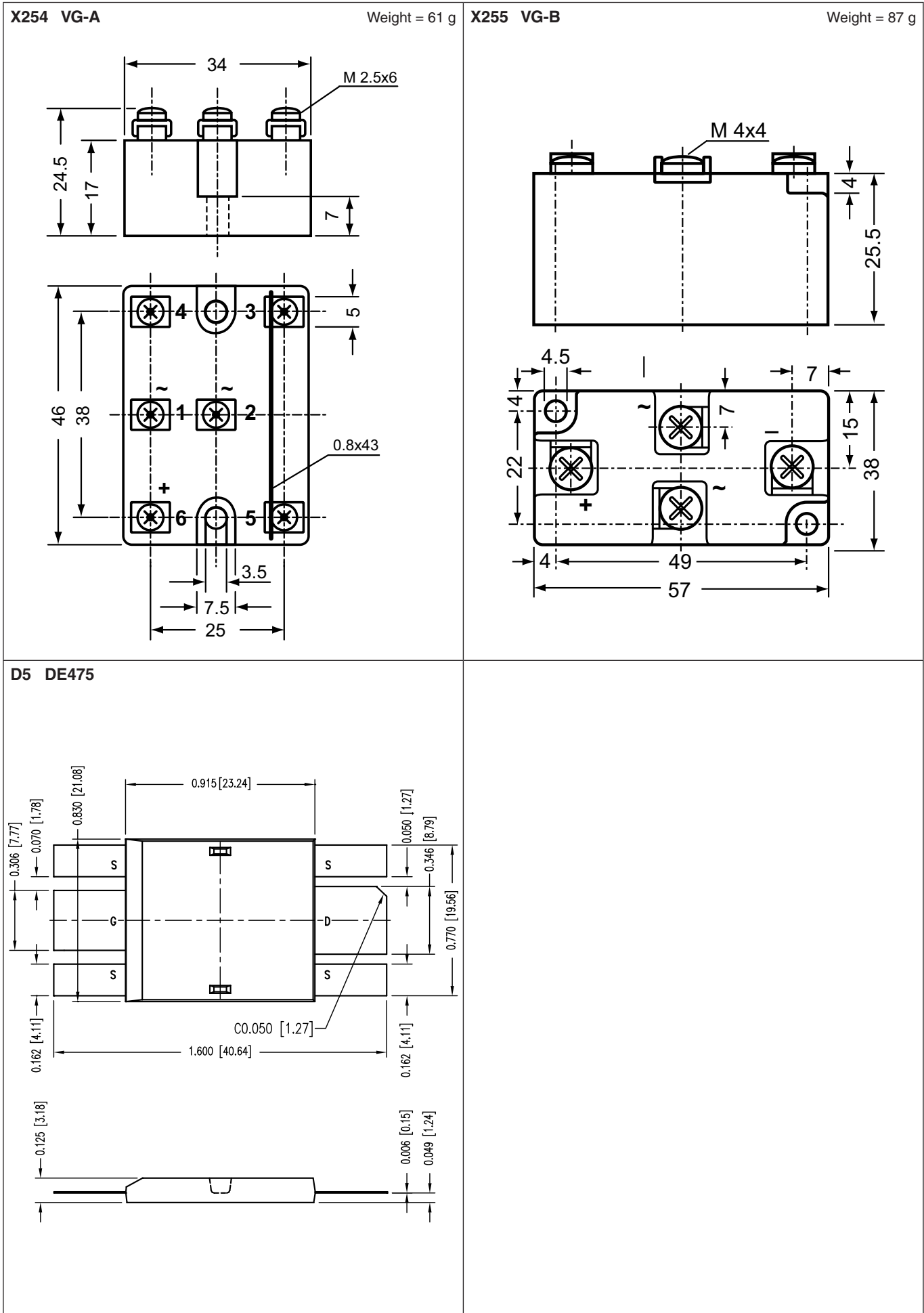

Dimensions in mm and inches (1 mm = 0.0394")

L001 SOT-223 Weight = 0.11 g

Dim.	Millimeters			Inches		
	min	typ	max	min	typ	max
A	6.30	6.50	6.70	0.248	0.256	0.264
B	3.30	3.50	3.70	0.130	0.138	0.146
C	-	-	1.80	-	-	0.071
D	0.02	-	0.10	0.001	-	0.004
E	2.90	3.00	3.15	0.114	0.118	0.124
F	0.60	0.70	0.85	0.024	0.027	0.034
G	-	2.30	-	-	0.090	-
H	-	4.60	-	-	0.181	-
I	6.70	7.00	7.30	0.264	0.276	0.287
J	0.24	0.26	0.35	0.009	0.010	0.014
K	10° max					

L002 TO-218AC Weight = 5 g

Dim.	Millimeter		Inches	
	min	max	min	max
A	20.57	21.21	0.810	0.835
B	15.49	16.00	0.610	0.630
C	4.52	4.78	0.178	0.188
D	1.40	1.78	0.055	0.070
E	12.37	12.62	0.487	0.497
F	16.13	16.64	0.635	0.655
G	0.56	0.74	0.022	0.029
H	1.91	2.41	0.075	0.095
J	14.61	15.88	0.575	0.625
K	5.36	5.56	0.211	0.219
L	10.72	11.10	0.422	0.437
M	1.47	1.73	0.058	0.068
N	1.14	1.40	0.045	0.055
P	2.41	2.92	0.095	0.115
Q	0.20	0.41	0.008	0.016
R	0.20	0.41	0.008	0.016
U	4.10	4.20	0.164	0.165
W	2.17	2.42	0.085	0.095

L002a TO-218X Weight = 5.2 g

Dim.	Millimeter		Inches	
	min	max	min	max
A	20.57	21.21	0.810	21.210
B	15.49	16.00	0.610	16.000
C	4.52	4.78	0.178	4.780
D	1.40	1.78	0.055	1.780
E	12.37	12.62	0.487	12.620
F	16.13	16.64	0.635	16.640
G	0.56	0.74	0.022	0.740
H	1.91	2.41	0.075	2.410
J	14.61	15.88	0.575	15.880
K	6.50	6.71	0.256	6.710
L	5.58	5.79	0.220	5.790
M	2.03	2.24	0.080	2.240
N	4.29	4.49	0.169	4.490
P	0.86	1.07	0.034	1.070
R	2.87	3.07	0.113	3.070
S	2.18	2.44	0.086	2.440
T	3.96	4.22	0.156	4.220
U	0.41	0.42	0.164	0.420
V	15.31	15.70	0.603	15.700
W	0.00	0.13	0.000	0.130
X	0.07	0.30	0.003	0.300
Y	0.71	0.81	0.028	0.810
Z	2.17	2.42	0.085	2.420

Note: Maximum torque to be applied to mounting tab is 8 in-lbs. (0.904 Nm)

L003a DO-214AA Weight = 0.1 g

Dim.	Millimeters		Inches	
	min	max	min	max
A	1.950	2.200	0.077	0.086
B	4.060	4.570	0.160	0.180
C	3.300	3.940	0.130	0.155
D	2.130	2.440	0.084	0.096
E	0.760	1.520	0.030	0.060
F	-	0.203	-	0.008
G	5.210	5.590	0.205	0.220
H	0.152	0.305	0.006	0.012

L003b DO-214AB Weight = 0.2 g

Dim.	Millimeters		Inches	
	min	max	min	max
A	2.900	3.200	0.114	0.126
B	6.600	7.110	0.260	0.280
C	5.590	6.220	0.220	0.245
D	2.060	2.620	0.079	0.103
E	0.760	1.520	0.030	0.060
F	-	0.203	-	0.008
G	7.750	8.130	0.305	0.320
H	0.152	0.305	0.006	0.012

L004 TO-252AA Weight = 0.3 g

Dim.	Millimeters			Inches		
	min	nom	max	min	nom	max
A	0.94	1.01	1.09	0.037	0.040	0.043
B	5.97	6.16	6.22	0.235	0.243	0.245
C	2.69	2.74	2.87	0.106	0.108	0.113
D	5.21	5.29	5.41	0.205	0.208	0.213
E	6.48	6.65	6.73	0.255	0.262	0.265
F	0.69	0.80	0.84	0.027	0.031	0.033
G	2.21	2.28	2.36	0.087	0.090	0.093
H	2.16	2.33	2.41	0.085	0.092	0.095
I	4.47	4.55	4.67	0.176	0.179	0.184
J	0.46	0.51	0.58	0.018	0.020	0.023
K	0.90	0.95	1.00	0.04	0.04	0.04
L	0.46	0.51	0.58	0.018	0.020	0.023
M	0.00	0.00	0.10	0.000	0.000	0.004
N	0.53	0.67	0.69	0.02	0.03	0.03
O	0°	0°	5°	0°	0°	5°
P	1.06	1.20	1.32	0.042	0.047	0.052
Q	0.86	1.00	1.11	0.034	0.039	0.044

Dimensions in mm and inches (1 mm = 0.0394")

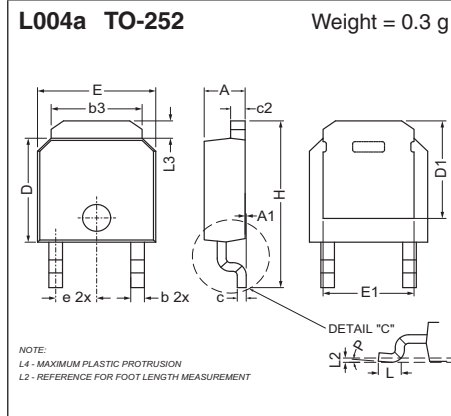

Dim.	Millimeters			Inches		
	min	nom	max	min	nom	max
A	2.16	2.29	2.41	0.085	0.090	0.095
A1	0	0.08	0.13	0	0.003	0.005
b	0.64	0.76	0.89	0.025	0.030	0.035
b3	4.95	5.08	5.46	0.195	0.200	0.215
c	0.46	0.51	0.61	0.018	0.020	0.024
C2	0.46	0.81	0.89	0.018	0.032	0.035
D	5.97	6.10	6.22	0.235	0.240	0.245
D1	5.21	-	-	0.205	-	-
E	6.35	6.60	6.73	0.250	0.260	0.265
E1	4.32	-	-	0.170	-	-
e	2.29 BSC			0.090 BSC		
H	9.40	9.83	10.41	0.370	0.387	0.410
L	1.02	1.14	1.27	0.040	0.045	0.050
L2	0.25 BSC			0.010 BSC		
L3	0.89	-	1.27	0.035	-	0.050
P	0°	-	8°	0°	-	8°

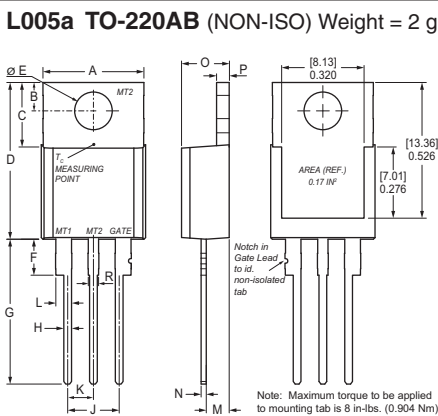

Dim.	Millimeters		Inches	
	min	max	min	max
A	9.65	10.67	0.380	0.420
B	2.67	2.92	0.105	0.115
C	5.84	6.35	0.230	0.250
D	14.99	15.75	0.590	0.620
E	3.61	3.73	0.142	0.147
F	2.79	3.30	0.110	0.130
G	13.72	14.61	0.540	0.575
H	0.64	0.89	0.025	0.035
J	4.95	5.21	0.195	0.205
K	2.41	2.67	0.095	0.105
L	1.52	1.91	0.060	0.075
M	2.16	2.41	0.085	0.095
N	0.46	0.61	0.018	0.024
O	4.52	4.78	0.178	0.188
P	1.14	1.52	0.045	0.060
R	0.97	1.22	0.038	0.048

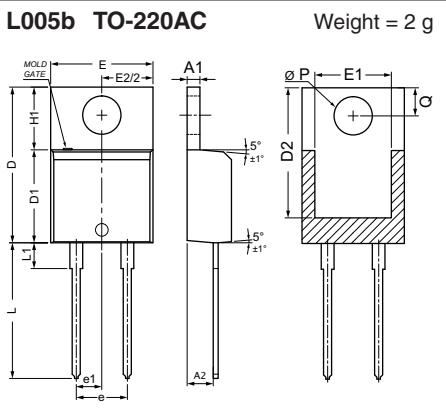

Dim.	Millimeter		
	min	nominal	max
A	4.320	4.450	4.570
A1	1.140	1.270	1.400
A2	2.500	-	2.740
b	0.690	-	0.880
b1	0.680	-	0.870
b2	1.230	-	1.390
b3	1.220	1.270	1.380
c	0.360	-	0.503
c1	0.630	-	0.527
D	14.900	-	15.600
D1	8.615	-	9.017
D2	12.840	-	12.950
E	10.000	10.180	10.360
E1	7.570	7.610	7.680
e1	2.490	2.540	2.590
e	5.030	5.080	5.130
H1	6.295	6.545	6.795
L	13.000	13.500	14.000
L1	2.390	-	3.250
øP	3.710	3.840	3.960
Q	2.650	-	3.050
R	-	-	0.254

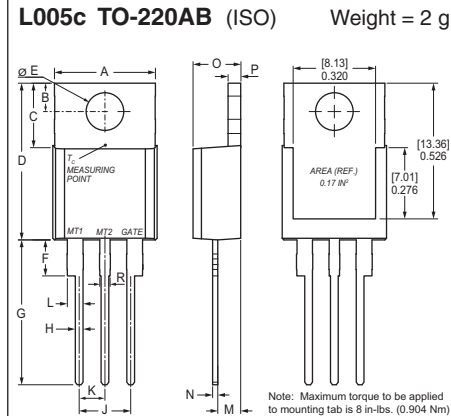

Dim.	Millimeters		Inches	
	min	max	min	max
A	9.65	10.67	0.380	0.420
B	2.67	2.92	0.105	0.115
C	5.84	6.35	0.230	0.250
D	14.99	15.75	0.590	0.620
E	3.61	3.73	0.142	0.147
F	2.79	3.30	0.110	0.130
G	13.72	14.61	0.540	0.575
H	0.64	0.89	0.025	0.035
J	4.95	5.21	0.195	0.205
K	2.41	2.67	0.095	0.105
L	1.52	1.91	0.060	0.075
M	2.16	2.41	0.085	0.095
N	0.46	0.61	0.018	0.024
O	4.52	4.78	0.178	0.188
P	1.14	1.52	0.045	0.060
R	0.97	1.22	0.038	0.048

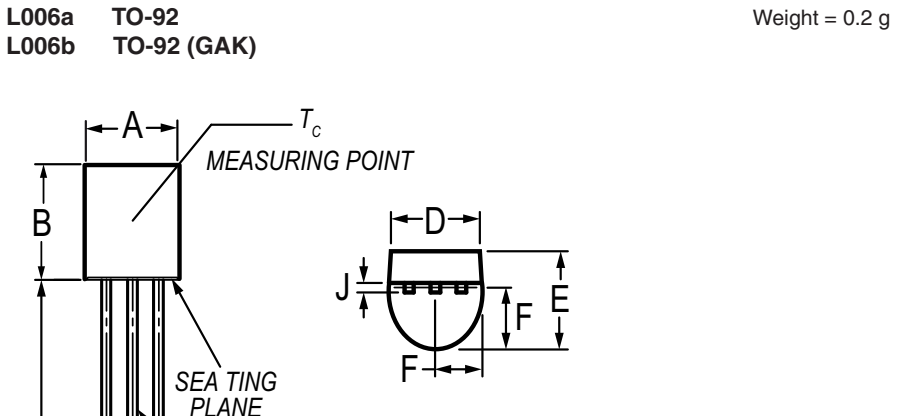

Dim.	Millimeters		Inches	
	min	max	min	max
A	4.450	5.200	0.175	0.205
B	4.320	5.330	0.170	0.210
C	12.70	-	0.500	-
D	3.430	-	0.135	-
E	3.180	4.190	0.125	0.165
F	2.040	2.660	0.080	0.105
G	0.407	0.533	0.016	0.021
H	1.150	1.390	0.045	0.055
I	2.420	2.660	0.095	0.105
J	0.380	0.500	0.015	0.020

Dimensions in mm and inches (1 mm = 0.0394")

L007 SMT0-263 Weight = 2.6 g

Dim.	Millimeters		Inches	
	min	max	min	max
A	14.44	15.24	0.568	0.600
B	9.65	10.67	0.38	0.420
C	2.50	2.90	0.098	0.114
D	4.30	4.80	0.169	0.189
E	2.60	3.00	0.102	0.118
F	4.52	4.78	0.178	0.188
G	1.14	1.52	0.045	0.06
H	9.14	9.40	0.360	0.370
I	2.69	3.09	0.106	0.122
J	1.75	2.25	0.069	0.089
U	0	0.25	0	0.010

L008 1206 SMD Weight = 0.008 g

Dim.	Millimeters		Inches	
	min	max	min	max
A	3.022	3.378	0.119	0.133
B	1.430	1.730	0.056	0.068
C	0.820	0.850	0.027	0.039
D	0.320	0.720	0.012	0.028

L011b TO-263AB Weight = 1.5 g

Dim.	Millimeter		Inches	
	min	max	min	max
A	9.14	9.40	0.360	0.370
B	9.65	10.67	0.380	0.420
C	4.52	4.78	0.178	0.188
D	0.64	0.89	0.025	0.035
E	1.14	1.52	0.045	0.060
F	1.52	1.91	0.060	0.075
G	2.41	2.67	0.095	0.105
H	2.34	2.59	0.092	0.102
J	0.46	0.61	0.018	0.024
K	2.29	2.79	0.090	0.110
S	14.99	15.88	0.590	0.625
V	0.89	1.14	0.035	0.045
U	0.05	0.25	0.002	0.010
W	1.02	1.78	0.040	0.070

X011c TO-263 AB (D²PAK HV) Weight = 1.5 g

Dim.	Millimeters		Inches	
	min	max	min	max
A	4.06	4.83	0.160	0.190
A1	typ 0.10		typ 0.004	
A2	2.41		0.095	
b	0.51	0.99	0.020	0.039
b2	1.14	1.40	0.045	0.055
c	0.40	0.74	0.016	0.029
c2	1.14	1.40	0.045	0.055
D	8.38	9.40	0.330	0.370
D1	8.00	8.89	0.315	0.350
D2	2.5		0.098	
E	9.65	10.41	0.380	0.410
E1	6.22	8.50	0.245	0.335
e	2.54 BSC		0.100 BSC	
e1	4.28		0.169	
H	14.61	15.88	0.575	0.625
L	1.78	2.79	0.070	0.110
L2	1.02	1.68	0.040	0.066
W	typ 0.02	0.040	typ 0.0008	0.002

Dimensions in mm and inches (1 mm = 0.0394")

L012b TO-263 (7)
c) middle leg cut

Weight = 2.5 g

Dim.	Millimeter		Inches	
	min	max	min	max
A	4.20	4.60	0.165	0.181
A1	2.45	2.75	0.096	0.108
b	0.65	0.90	0.026	0.035
c	0.40	0.60	0.016	0.024
c2	1.14	1.40	0.045	0.055
D	8.38	8.64	0.330	0.340
D1	6.10	6.35	0.240	0.250
E	10.00	10.30	0.394	0.406
E1	7.34	8.00	0.290	0.315
e	1.27 BSC		0.050 BSC	
L	14.73	15.75	0.580	0.620
L1	2.24	2.84	0.088	0.112
L2	1.35	1.55	0.053	0.061

L014a TO-247AD

Weight = 6 g

Dim.	Millimeter		Inches	
	min	max	min	max
A	4.70	5.30	0.185	0.209
A1	2.21	2.59	0.087	0.102
A2	1.50	2.49	0.059	0.098
b	0.99	1.40	0.039	0.055
b2	1.65	2.39	0.065	0.094
b4	2.59	3.43	0.102	0.135
c	0.38	0.89	0.015	0.035
D	20.79	21.45	0.819	0.845
D1	13.07	-	0.515	-
D2	0.51	1.35	0.020	0.053
E	15.48	16.24	0.610	0.640
E1	13.45	-	0.53	-
E2	4.31	5.48	0.170	0.216
e	5.45 BSC		0.215 BSC	
L	19.80	20.30	0.078	0.800
L1	-	4.49	-	0.177
Ø P	3.55	3.65	0.140	0.144
Ø P1	-	7.39	-	0.290
Q	5.38	6.19	0.212	0.244
S	6.14 BSC		0.242 BSC	

L014b TO-247 AD

Weight = 6 g

Dim.	Millimeters		Inches	
	min	max	min	max
A	4.70	5.30	0.185	0.209
A1	2.21	2.59	0.087	0.102
A2	1.50	2.49	0.059	0.098
b	0.99	1.40	0.039	0.055
b2	1.65	2.39	0.065	0.094
b4	2.59	3.43	0.102	0.135
c	0.38	0.89	0.015	0.035
D	20.79	21.45	0.819	0.845
D1	13.07	-	0.515	-
D2	0.51	1.35	0.020	0.053
E	15.48	16.24	0.610	0.640
E1	13.45	-	0.530	-
E2	4.31	5.48	0.170	0.216
e	10.90 BSC		0.430 BSC	
L	19.80	20.30	0.078	0.800
L1	-	4.49	-	0.177
Ø P	3.55	3.65	0.140	0.144
Ø P1	-	7.39	-	0.290
Q	5.38	6.19	0.212	0.244
S	6.14 BSC		0.242 BSC	

L014d TO-247-4L

Weight = 6 g

Dim.	Millimeters		Inches	
	min	max	min	max
A	4.70	5.31	0.185	0.209
A1	2.21	2.59	0.087	0.102
A2	1.85	2.16	0.073	0.085
b	1.10	1.30	0.043	0.051
b2	1.30	1.50	0.051	0.059
c	0.50	0.89	0.020	0.035
D	20.80	21.46	0.819	0.845
D1	13.50	-	-	-
e	2.54 BSC		0.100 BSC	
e1	5.08 BSC		0.200 BSC	
E	15.49	16.26	0.610	0.640
E1	13.06	14.15	0.514	0.557
E2	4.32	4.83	0.170	0.190
L	19.81	20.57	0.780	0.810
L1	3.81	4.50	0.150	0.177
Ø P	3.55	3.70	0.140	0.146
Ø P1	7.00	7.40	0.276	0.291
Q	5.38	6.20	0.212	0.244
S	6.15 BSC		0.242 BSC	

Dimensions in mm and inches (1 mm = 0.0394")

L015 SOT-23 Weight = 0.008 g

Dim.	Millimeter		Inches	
	min	max	min	max
A	0.89	1.17	0.035	0.046
A1	0.05	0.15	0.001	0.006
b	0.30	0.50	0.012	0.020
c	0.08	0.20	0.003	0.008
D	2.80	3.00	0.110	0.118
E	1.20	1.40	0.047	0.055
e	1.90 BSC		0.075 BSC	
L	0.40	0.58	0.016	0.023
L1	0.46	0.64	0.018	0.025
H _E	2.10	2.49	0.083	0.098
∅	0°		10°	

L016 SOT-89 Weight = 0.045 g

Dim.	Millimeter		Inches	
	min	max	min	max
A	4.40	4.60	0.173	0.181
B	2.29	2.60	0.090	0.102
C	1.40	1.60	0.055	0.063
D	3.94	4.25	0.155	0.167
E	0.89	1.20	0.035	0.047
F	1.42	1.57	0.056	0.062
G	2.92	3.07	0.115	0.121
H	0.35	0.44	0.014	0.017
I	0.36	0.48	0.014	0.019
J	1.62	1.83	0.064	0.072

L019a TO-268 AA (D³PAK HV) Weight = 4 g

Dim.	Millimeters		Inches	
	min	max	min	max
A	4.90	5.10	0.193	0.201
A1	2.70	2.90	0.106	0.114
A2	0.02	0.25	0.001	0.100
b	1.15	1.45	0.045	0.057
C	0.40	0.65	0.016	0.026
C 2	1.45	1.60	0.057	0.063
D	13.80	14.00	0.543	0.551
D1	11.80	12.10	0.465	0.476
D2	7.50	7.80	0.295	0.307
D3	2.90	3.20	0.114	0.126
E	15.85	16.05	0.624	0.632
E1	13.30	13.60	0.524	0.535
e	5.45 BSC		0.215 BSC	
H	18.70	19.10	0.736	0.752
L	1.70	2.00	0.067	0.079
L2	1.00	1.15	0.039	0.045
L3	0.25 BSC		0.010 BSC	
L4	3.80	4.10	0.150	0.161

L027a SOT-227 B miniBLOC Weight = 29 g

Dim.	Millimeters		Inches	
	min	max	min	max
A	31.50	31.88	1.240	1.255
B	7.80	8.20	0.307	0.323
C	4.09	4.29	0.161	0.169
D	4.09	4.29	0.161	0.169
E	4.09	4.29	0.161	0.169
F	14.91	15.11	0.587	0.595
G	30.12	30.30	1.186	1.193
H	37.80	38.23	1.488	1.505
J	11.68	12.22	0.460	0.481
K	8.92	9.60	0.351	0.378
L	0.74	0.84	0.029	0.033
M	12.50	13.10	0.492	0.516
N	25.15	25.42	0.990	1.001
O	1.95	2.13	0.077	0.084
P	4.95	6.20	0.195	0.244
Q	26.54	26.90	1.045	1.059
R	3.94	4.42	0.155	0.174
S	4.55	4.85	0.179	0.191
T	24.59	25.25	0.968	0.994
U	-0.05	0.10	-0.002	0.004
V	3.20	5.50	0.126	0.217
W	19.81	21.08	0.780	0.830
Z	2.50	2.70	0.098	0.106

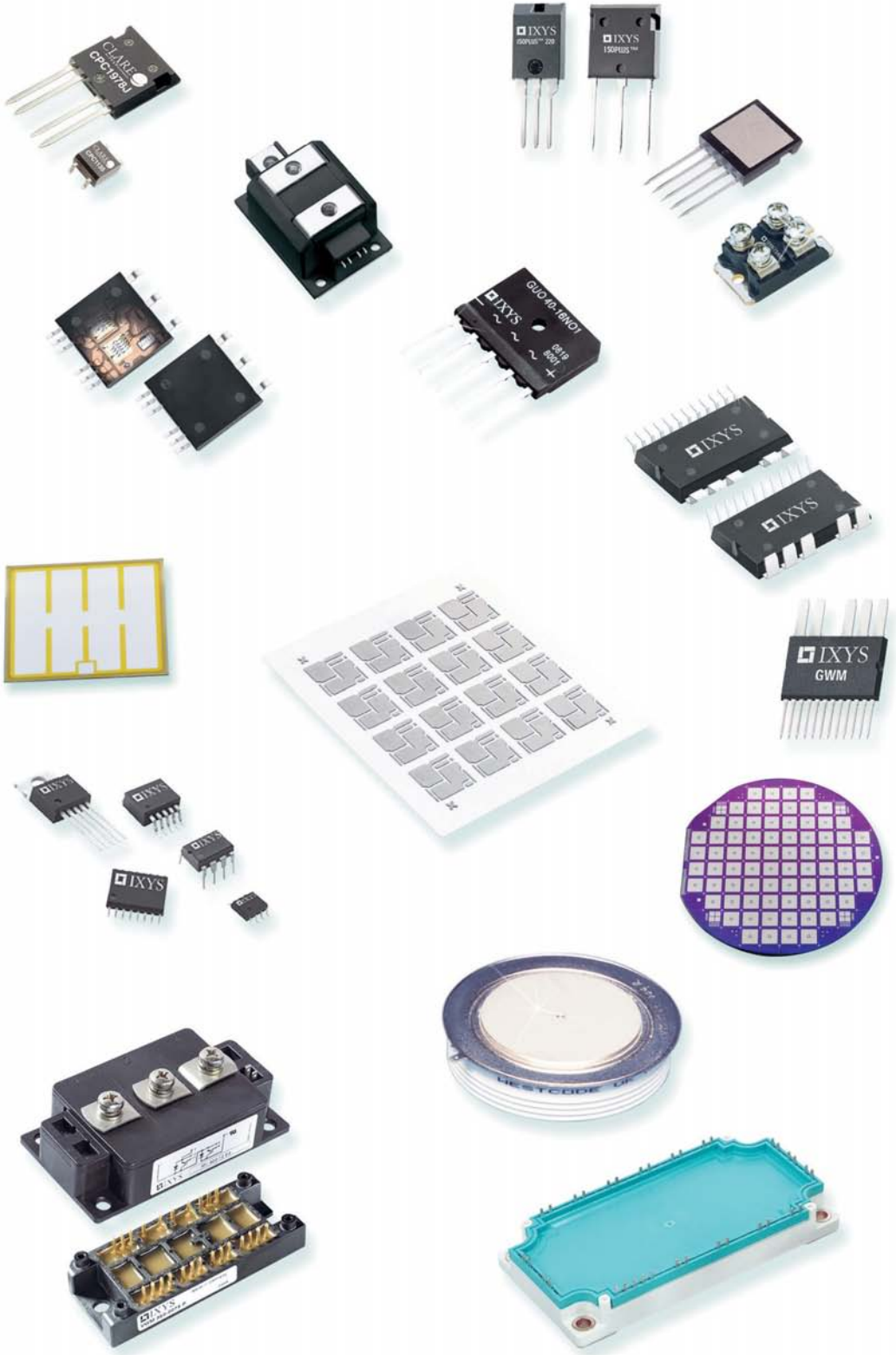

LOCAL RESOURCES FOR A GLOBAL MARKET

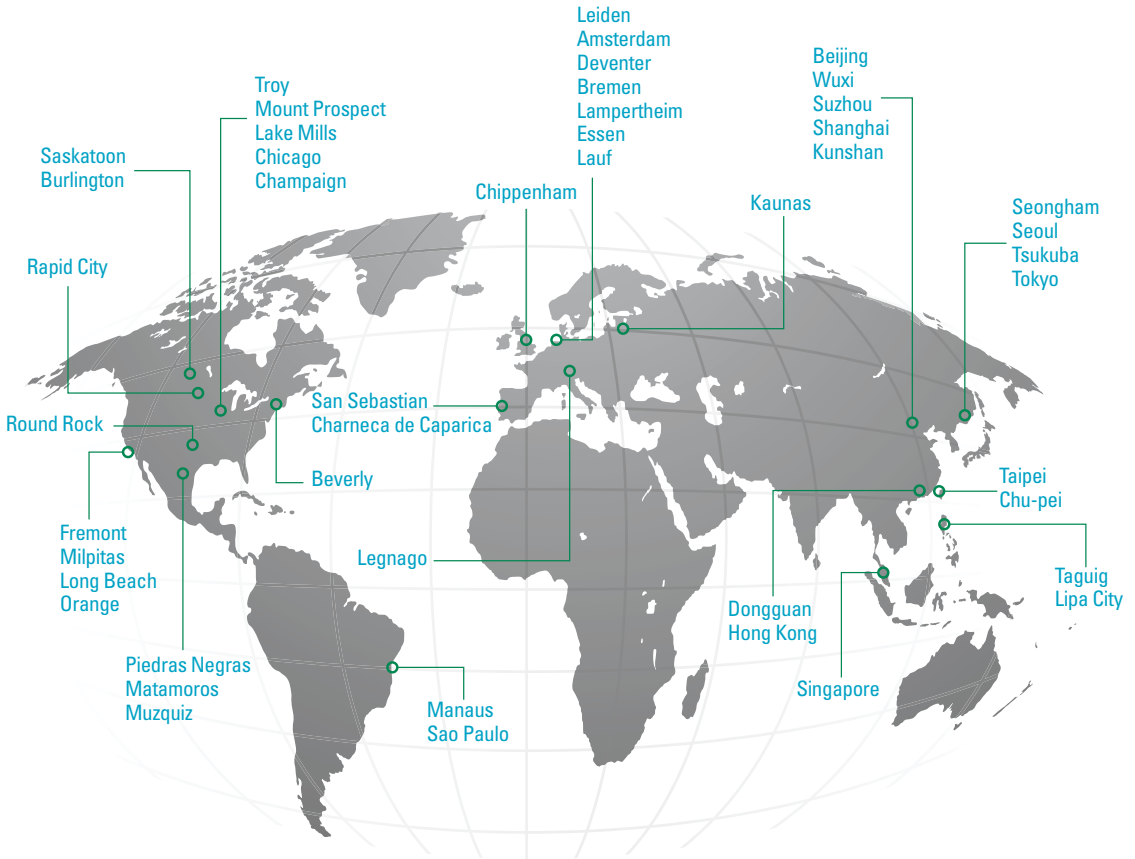

Disclaimer Notice – Information furnished is believed to be accurate and reliable. However, users should independently evaluate the suitability of and test each product selected for their own applications. Littelfuse products are not designed for, and may not be used in, all applications. Read complete Disclaimer Notice at www.littelfuse.com/product-disclaimer.

