

IRS2011(S)PbF

HIGH AND LOW SIDE DRIVER

Features

- Floating channel designed for bootstrap operation
- Fully operational up to +200 V
- Tolerant to negative transient voltage, dV/dt immune
- Gate drive supply range from 10 V to 20 V
- Independent low-side and high-side channels
- Input logic HIN/LIN active high
- Undervoltage lockout for both channels
- 3.3 V and 5 V input logic compatible
- CMOS Schmitt-triggered inputs with pull-down
- Matched propagation delay for both channels
- RoHS compliant

Applications

- Audio Class D amplifiers
- High power DC-DC SMPS converters
- DC motor drive

Description

The IRS2011 is a high power, high speed power MOSFET driver with independent high and low-side referenced output channels, ideal for Audio Class D and DC-DC converter applications. Logic inputs are compatible with standard CMOS or LSTTL output, down to 3.3 V logic. The output drivers feature a high pulse current buffer stage designed for minimum driver cross-conduction. Propagation delays are matched to simplify use in high frequency applications. The floating channel can be used to drive an N-channel power MOSFET in the high-side configuration which operates up to 200 V. Proprietary HVIC and latch immune CMOS technologies enable ruggedized monolithic construction.

Product Summary

V_{OFFSET}	200 V max.
$I_{\text{O}+/-}$	1.0 A / 1.0 A typ.
V_{OUT}	10 V - 20 V
$t_{\text{on/off}}$	60 ns typ.
Delay Matching	20 ns max.

Packages

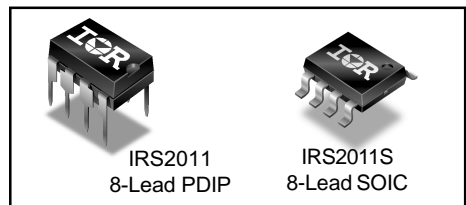

Typical Connection

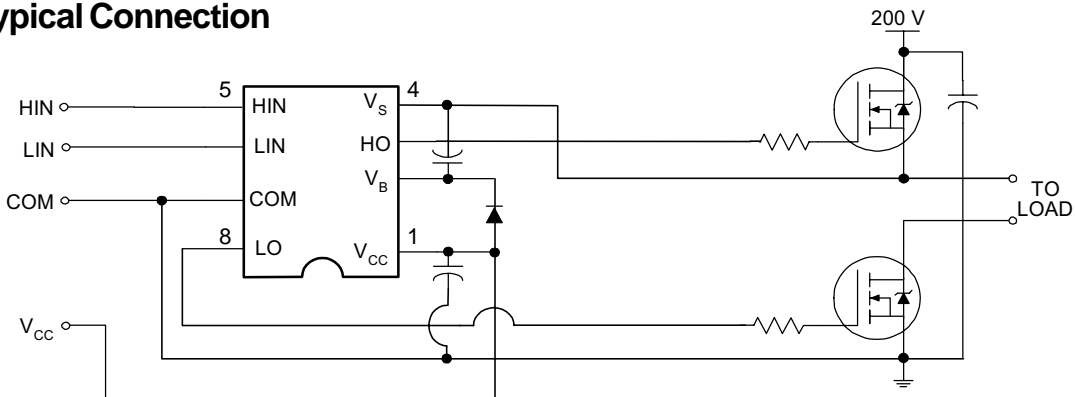

(Refer to Lead Assignments for correct configuration). This diagram shows electrical connections only. Please refer to our Application Notes and DesignTips for proper circuit board layout.

Absolute Maximum Ratings

Absolute maximum ratings indicate sustained limits beyond which damage to the device may occur. All voltage parameters are absolute voltages referenced to COM. The thermal resistance and power dissipation ratings are measured under board mounted and still air conditions.

Symbol	Definition	Min.	Max.	Units	
V_B	High-side floating supply voltage	-0.3	220 (Note 1)	V	
V_S	High-side floating supply offset voltage	$V_B - 20$	$V_B + 0.3$		
V_{HO}	High-side floating output voltage	$V_S - 0.3$	$V_B + 0.3$		
V_{CC}	Low-side fixed supply voltage	-0.3	20 (Note 1)		
V_{LO}	Low-side output voltage	-0.3	$V_{CC} + 0.3$		
V_{IN}	Logic input voltage (HIN & LIN)	-0.3	$V_{CC} + 0.3$		
dV_S/dt	Allowable offset supply voltage transient (Fig. 2)	—	50	V/ns	
P_D	Package power dissipation @ $T_A = +25\text{ }^\circ\text{C}$	(8-lead DIP)	—	1.0	W
		(8-lead SOIC)	—	0.625	
R_{THJA}	Thermal resistance, junction to ambient	(8-lead DIP)	—	125	$^\circ\text{C/W}$
		(8-lead SOIC)	—	200	
T_J	Junction temperature	—	150	$^\circ\text{C}$	
T_S	Storage temperature	-55	150		
T_L	Lead temperature (soldering, 10 seconds)	—	300		

Note 1: All supplies are fully tested at 25 V and an internal 20 V clamp exists for each supply.

Recommended Operating Conditions

For proper operation the device should be used within the recommended conditions. The V_S and COM offset ratings are tested with all supplies biased at a 15 V differential.

Symbol	Definition	Min.	Max.	Units
V_B	High-side floating supply absolute voltage	$V_S + 10$	$V_S + 20$	V
V_S	High-side floating supply offset voltage	Note 2	200	
V_{HO}	High-side floating output voltage	V_S	V_B	
V_{CC}	Low-side fixed supply voltage	10	20	
V_{LO}	Low-side output voltage	0	V_{CC}	
V_{IN}	Logic input voltage (HIN & LIN)	COM	5.5	
T_A	Ambient temperature	-40	125	

Note 2: Logic operational for V_S of -5 V to +200 V. Logic state held for V_S of -5 V to $-V_{BS}$.

Dynamic Electrical Characteristics

V_{BIAS} (V_{CC} , V_{BS}) = 15 V, C_L = 1000 pF, T_A = 25 °C unless otherwise specified. Figure 1 shows the timing definitions.

Symbol	Definition	Min.	Typ.	Max.	Units	Test Conditions
t_{on}	Turn-on propagation delay	—	60	80	ns	$V_S = 0V$
t_{off}	Turn-off propagation delay	—	60	80		$V_S = 200V$
t_r	Turn-on rise time	—	25	40		
t_f	Turn-off fall time	—	15	35		
DM1	Turn-on delay matching $t_{on}(H) - t_{on}(L)$	—	—	20		
DM2	Turn-off delay matching $t_{off}(H) - t_{off}(L)$	—	—	20		

Static Electrical Characteristics

V_{BIAS} (V_{CC} , V_{BS}) = 15 V, and T_A = 25 °C unless otherwise specified. The V_{IN} , V_{TH} , and I_{IN} parameters are referenced to COM and are applicable to all logic input leads: HIN and LIN. The V_O and I_O parameters are referenced to COM and are applicable to the respective output leads: HO or LO.

Symbol	Definition	Min.	Typ.	Max.	Units	Test Conditions
V_{IH}	Logic "1" input voltage	2.5	—	—	V	$V_{CC} = 10 V - 20 V$
V_{IL}	Logic "0" input voltage	—	—	0.7		
V_{OH}	High level output voltage, $V_{BIAS} - V_O$	—	—	1.4		$I_O = 0 A$
V_{OL}	Low level output voltage, V_O	—	—	0.1		$I_O = 20 mA$
I_{LK}	Offset supply leakage current	—	—	50	μA	$V_B = V_S = 200 V$
I_{QBS}	Quiescent V_{BS} supply current	—	120	210		$V_{IN} = 0 V$ or $3.3 V$
I_{QCC}	Quiescent V_{CC} supply current	—	200	300		
I_{IN+}	Logic "1" input bias current	—	3	10		$V_{IN} = 3.3 V$
I_{IN-}	Logic "0" input bias current	—	—	5.0		$V_{IN} = 0 V$
V_{BSUV+}	V_{BS} supply undervoltage positive going threshold	8.3	9.0	9.7	V	
V_{BSUV-}	V_{BS} supply undervoltage negative going threshold	7.5	8.2	8.9		
V_{CCUV+}	V_{CC} supply undervoltage positive going threshold	8.3	9.0	9.7		
V_{CCUV-}	V_{CC} supply undervoltage negative going threshold	7.5	8.2	8.9		
I_{O+}	Output high short circuit pulsed current	—	1.0	—	A	$V_O = 0 V$, $PW = 10 \mu s$
I_{O-}	Output low short circuit pulsed current	—	1.0	—		$V_O = 15 V$, $PW = 10 \mu s$

Functional Block Diagram

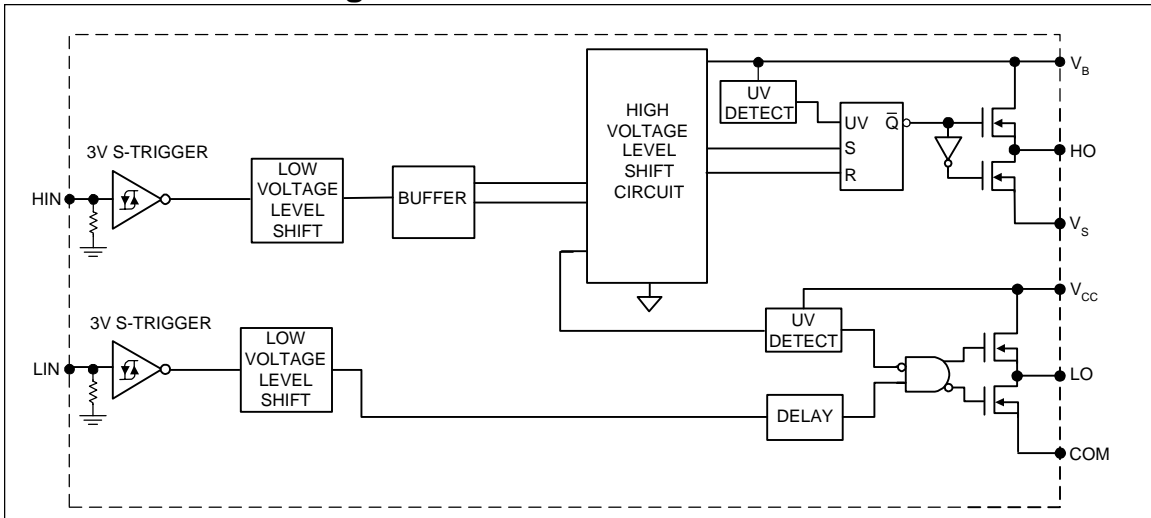

Lead Definitions

Symbol	Description
HIN	Logic input for high-side gate driver output (HO), in phase
LIN	Logic input for low-side gate driver output (LO), in phase
VB	High-side floating supply
HO	High-side gate drive output
VS	High-side floating supply return
VCC	Low-side supply
LO	Low-side gate drive output
COM	Low-side return

Lead Assignments

<p>8-Lead SOIC</p> <p>IRS2011S</p>	<p>8-Lead PDIP</p> <p>IRS2011</p>
Part Number	

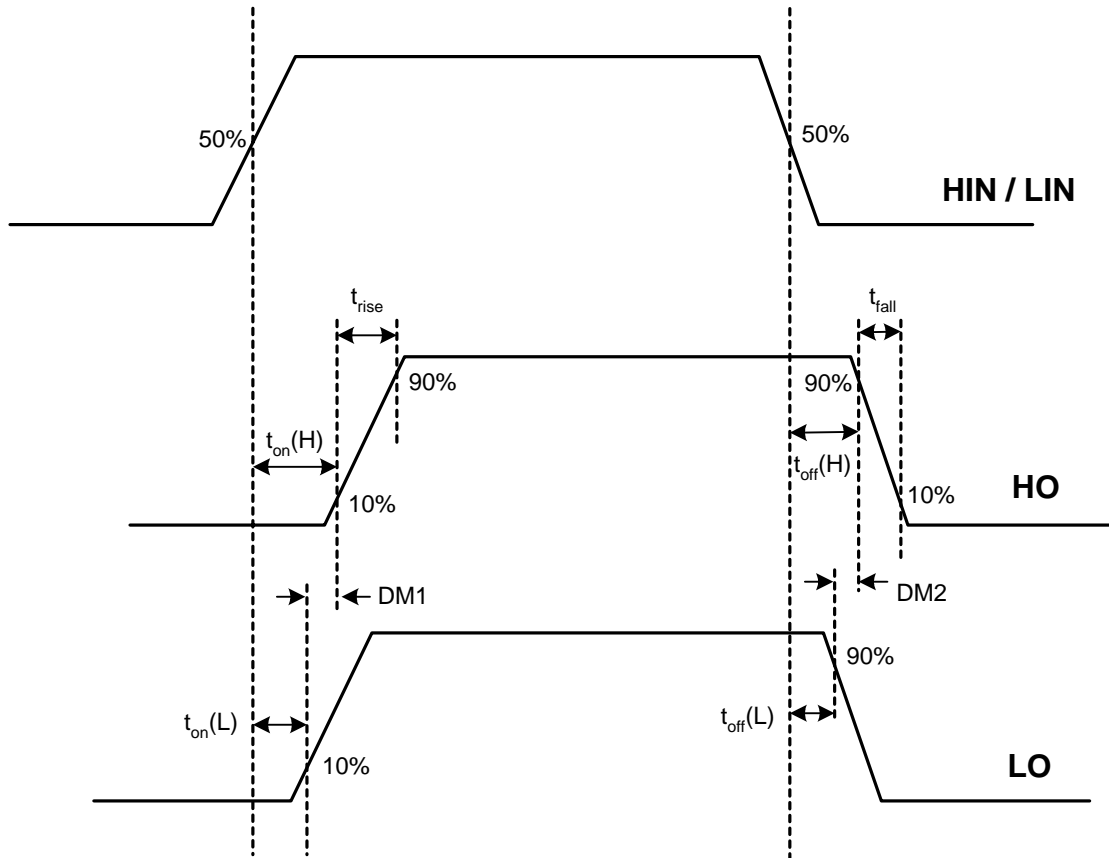

Figure 1. Timing Diagram

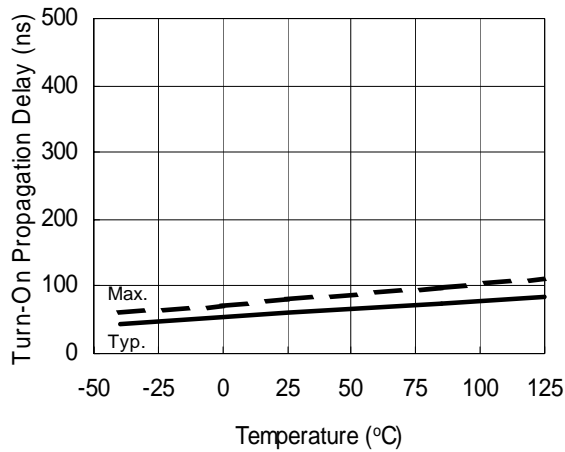

Figure 2A. Turn-On Propagation Delay vs. Temperature

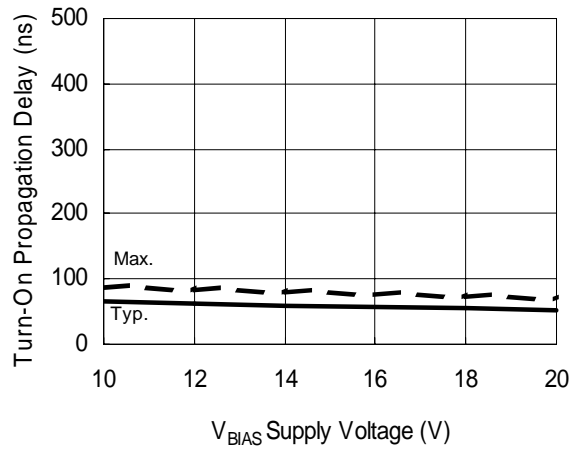

Figure 2B. Turn-On Propagation Delay vs. Supply Voltage

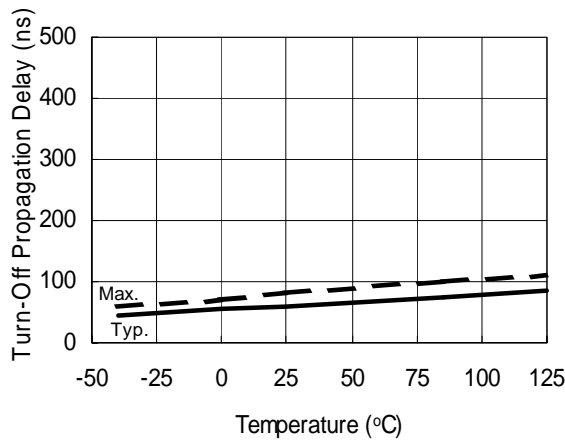

Figure 3A. Turn-Off Propagation Delay vs. Temperature

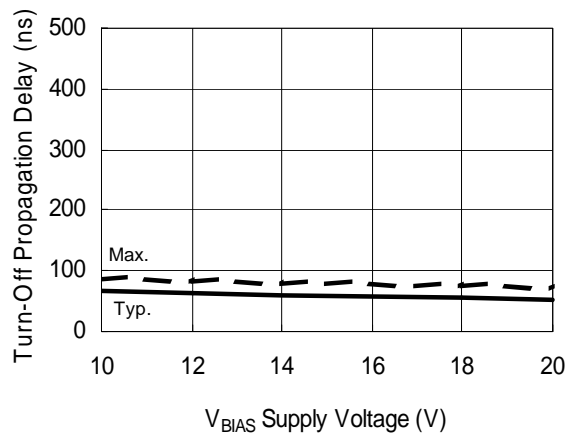

Figure 3B. Turn-Off Propagation Delay vs. Supply Voltage

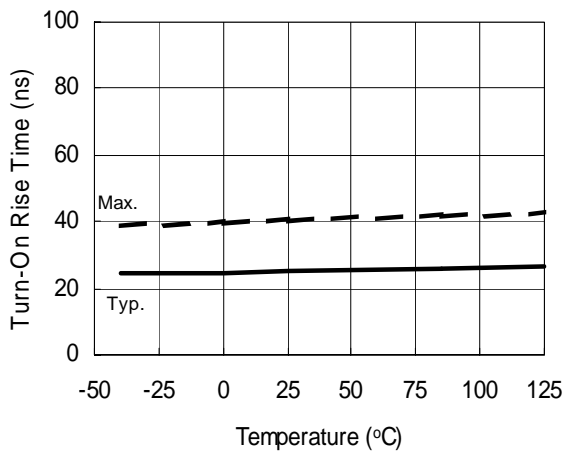

Figure 4A. Turn-On Rise Time vs. Temperature

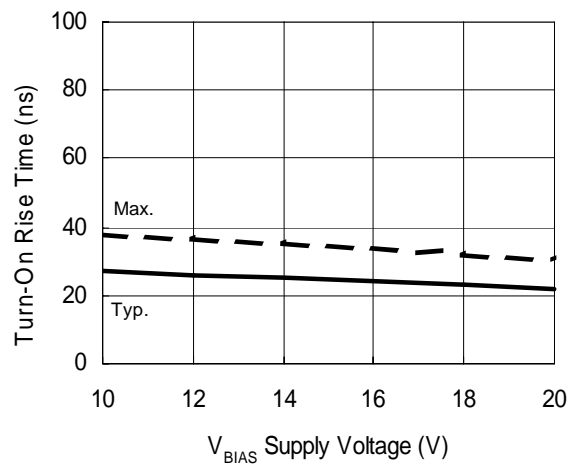

Figure 4B. Turn-On Rise Time vs. Supply Voltage

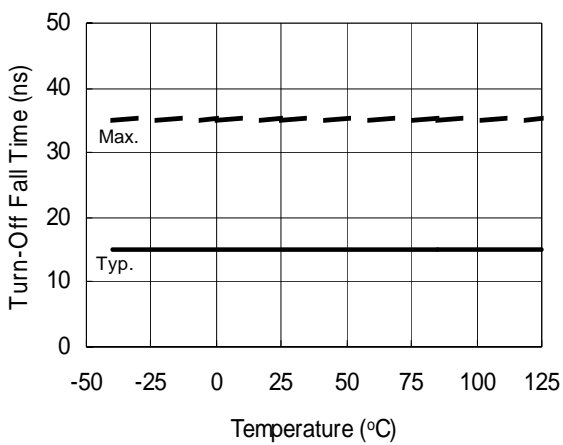

Figure 5A. Turn-Off Fall Time vs. Temperature

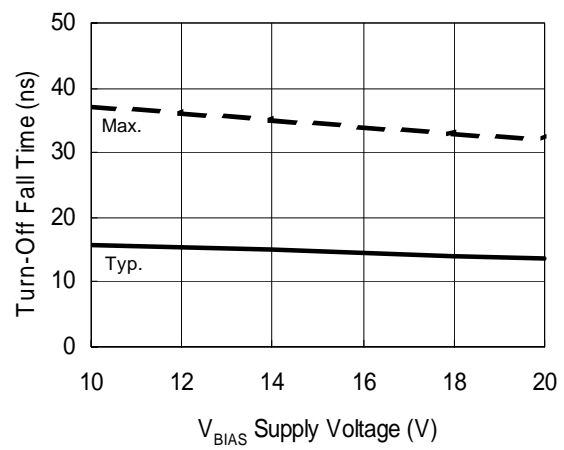

Figure 5B. Turn-Off Fall Time vs. Supply Voltage

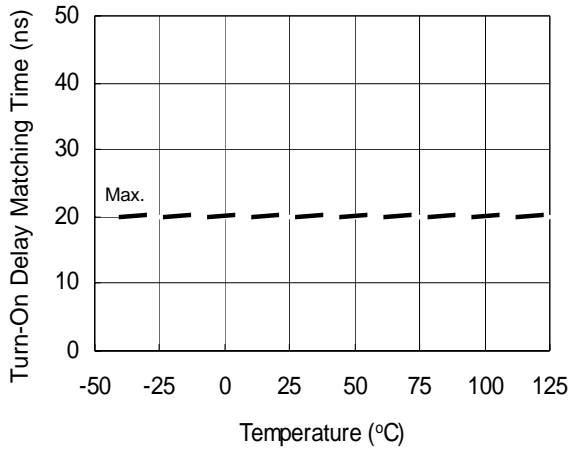

Figure 6A. Turn-On Delay Matching Time vs. Temperature

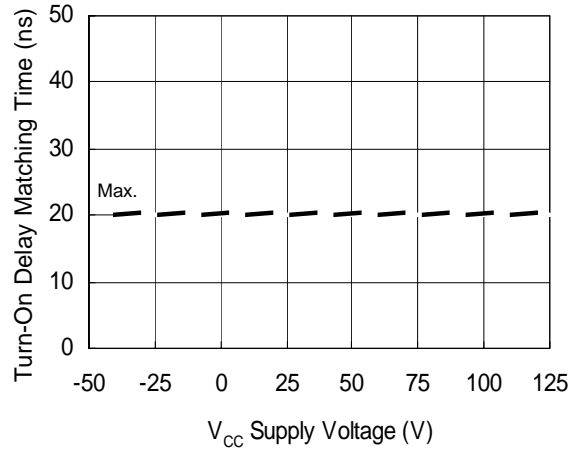

Figure 6B. Turn-On Delay Matching Time vs. Supply Voltage

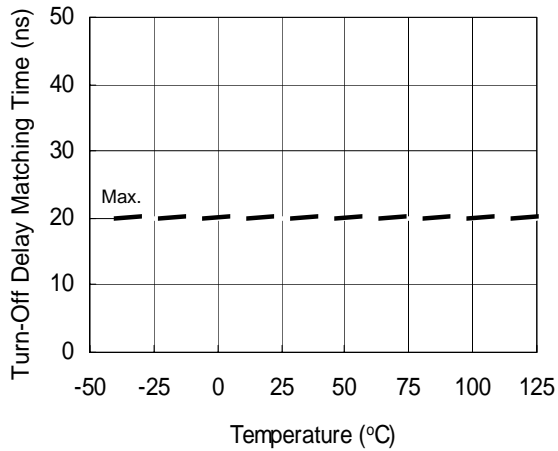

Figure 7A. Turn-Off Delay Matching Time vs. Temperature

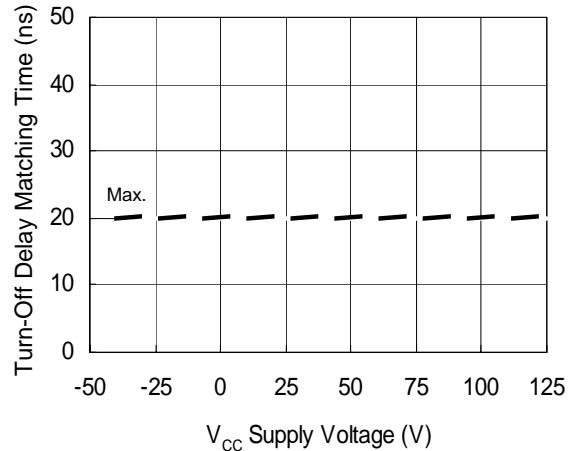

Figure 7B. Turn-Off Delay Matching Time vs. Supply Voltage

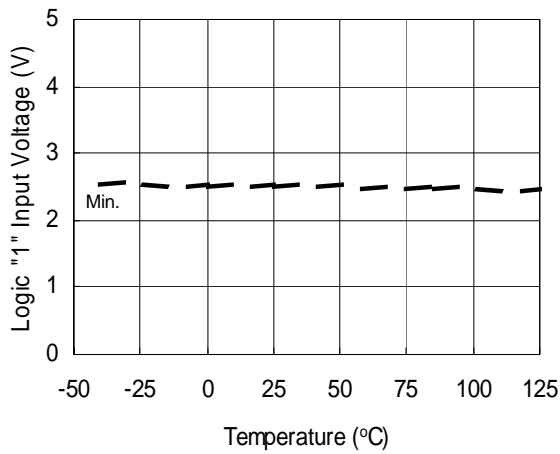

Figure 8A. Logic "1" Input Voltage vs. Temperature

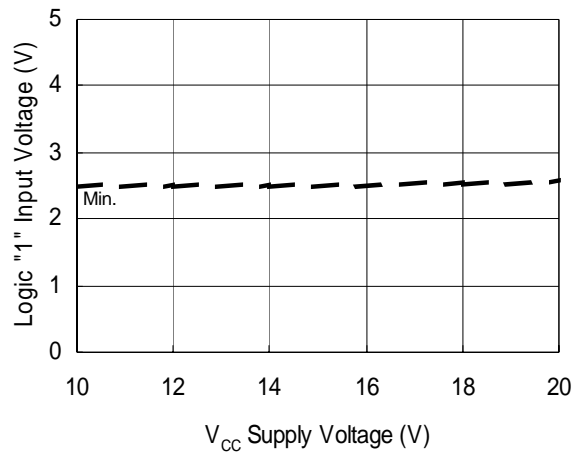

Figure 8B. Logic "1" Input Voltage vs. Supply Voltage

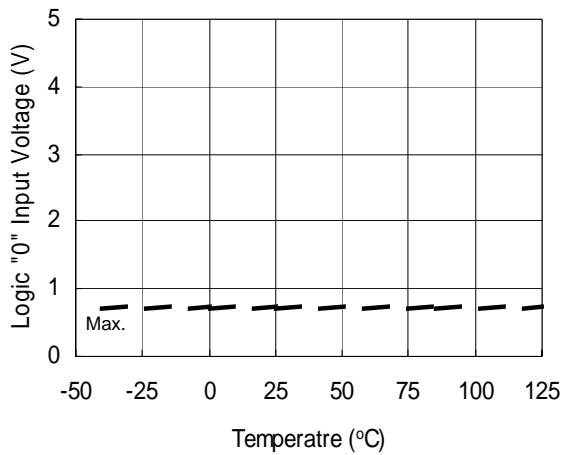

Figure 9A. Logic "0" Input Voltage vs. Temperature

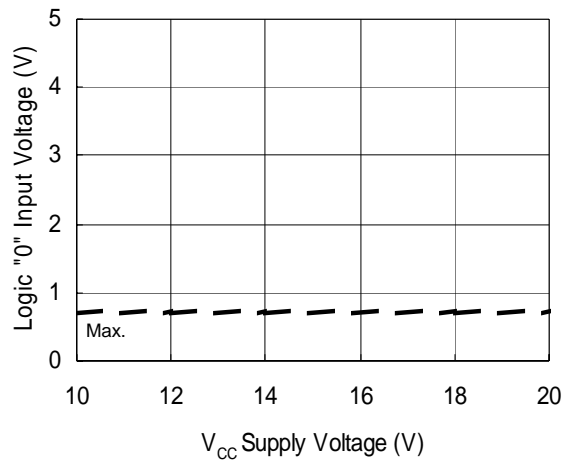

Figure 9B. Logic "0" Input Voltage vs. Supply Voltage

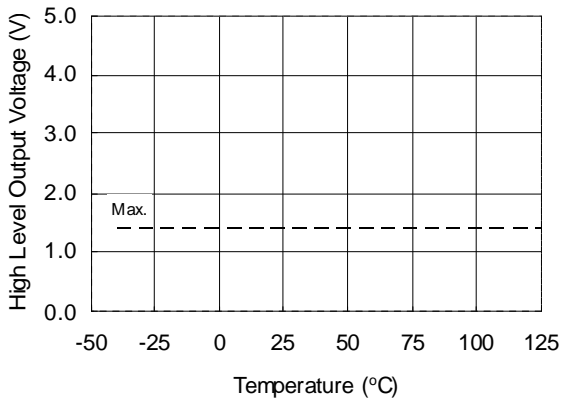

Figure 10A. High Level Output Voltage vs. Temperature ($I_O = 0$ mA)

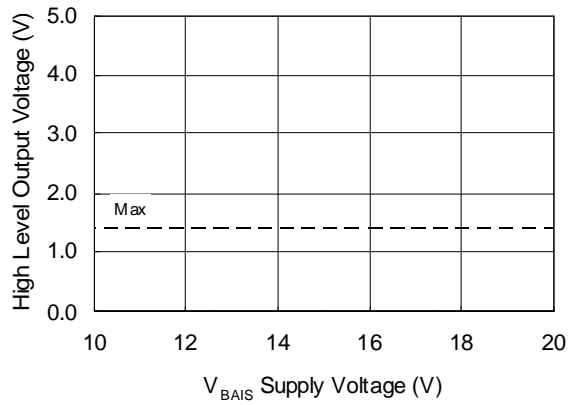

Figure 10B. High Level Output Voltage vs. Supply Voltage ($I_O = 0$ mA)

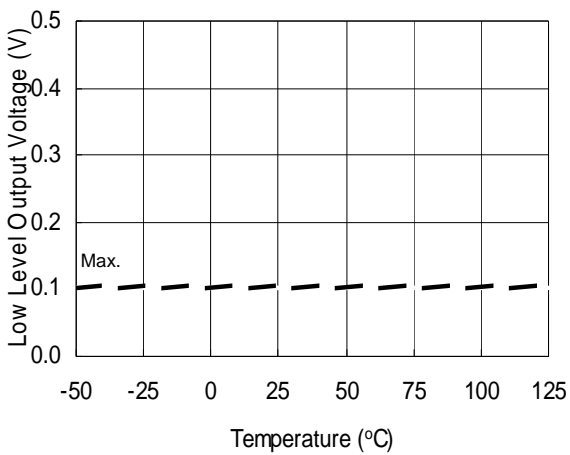

Figure 11A. Low Level Output vs. Temperature

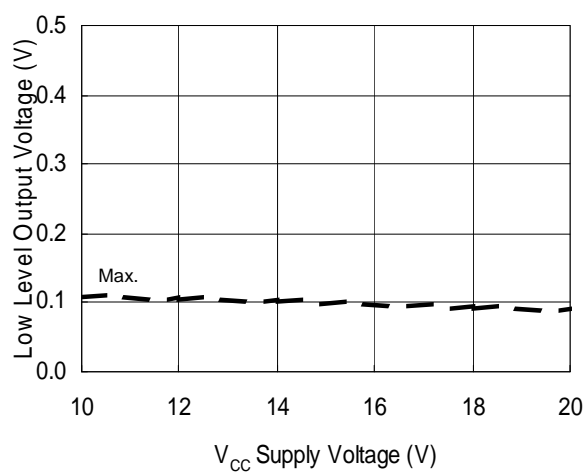

Figure 11B. Low Level Output vs. Supply Voltage

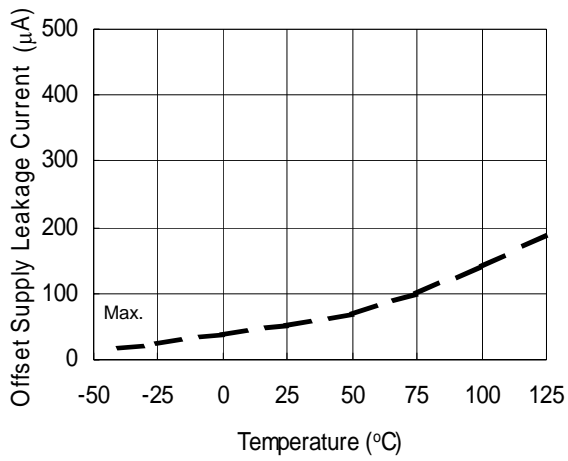

Figure 12A. Offset Supply Leakage Current vs. Temperature

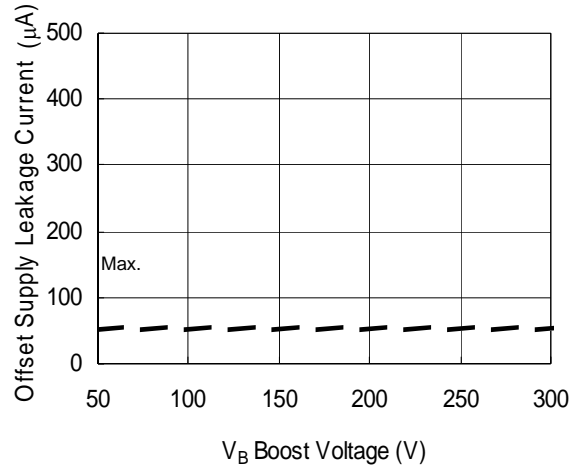

Figure 12B. Offset Supply Leakage Current vs. Supply Voltage

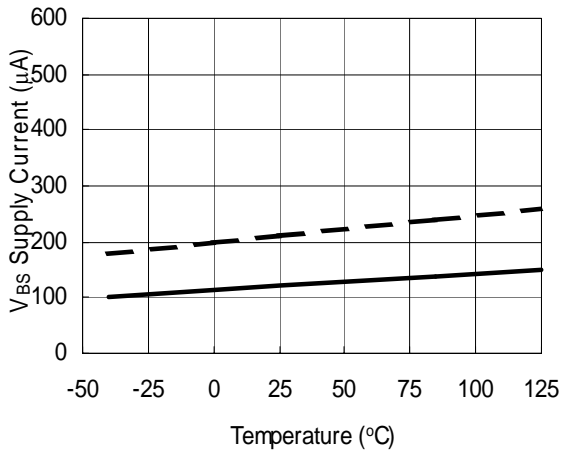

Figure 13A. V_{BS} Supply Current vs. Temperature

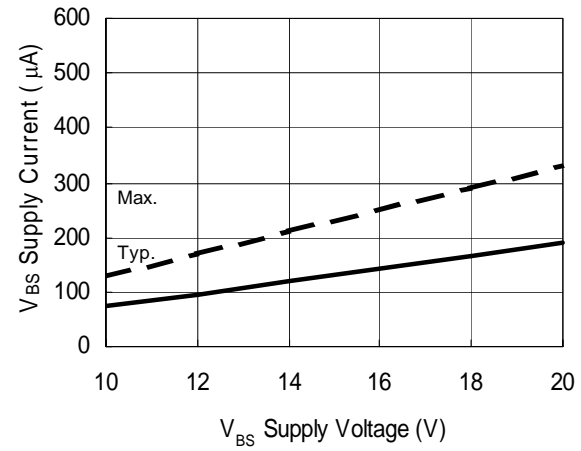

Figure 13B. V_{BS} Supply Current vs. Supply Voltage

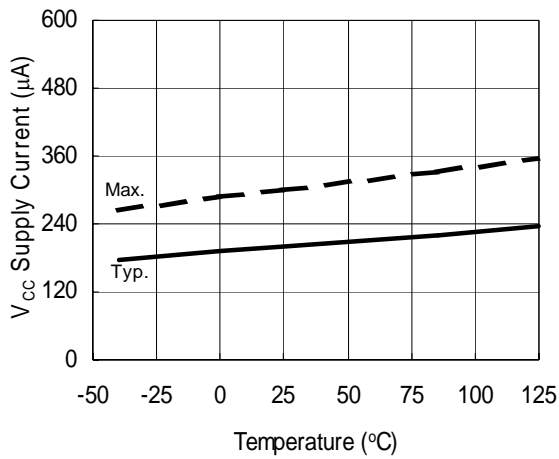

Figure 14A. V_{CC} Supply Current vs. Temperature

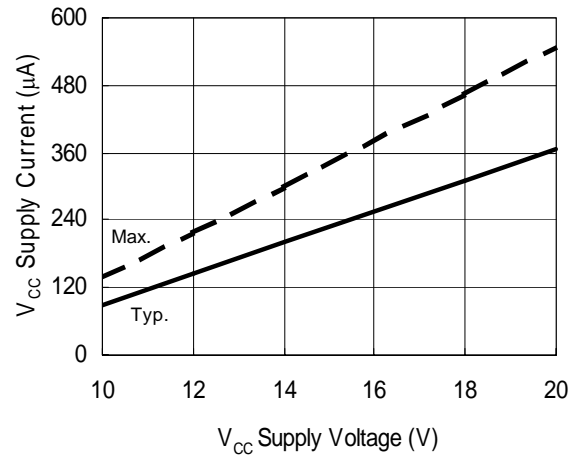

Figure 14B. V_{CC} Supply Current vs. Supply Voltage

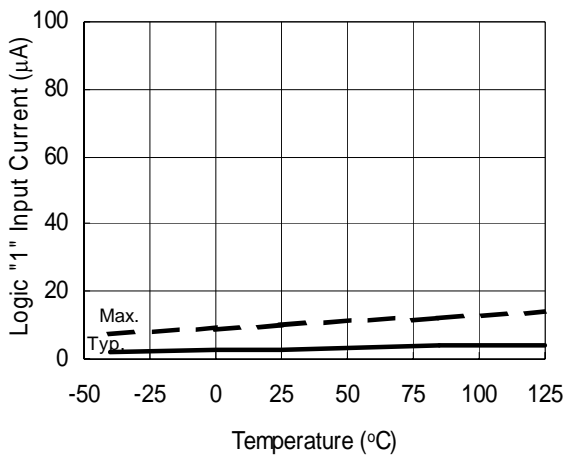

Figure 15A. Logic "1" Input Current vs. Temperature

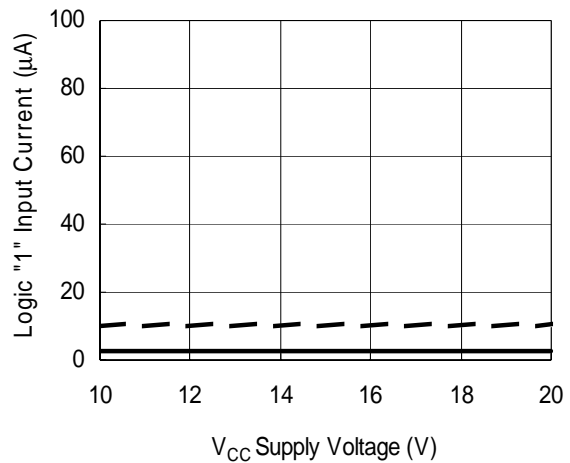

Figure 15B. Logic "1" Input Current vs. Supply Voltage

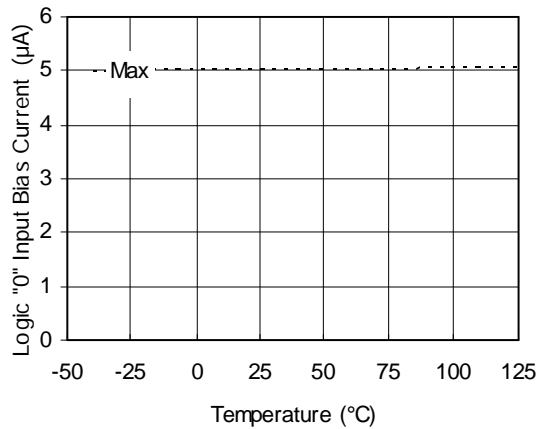

Figure 16A. Logic "0" Input Bias Current vs. Temperature

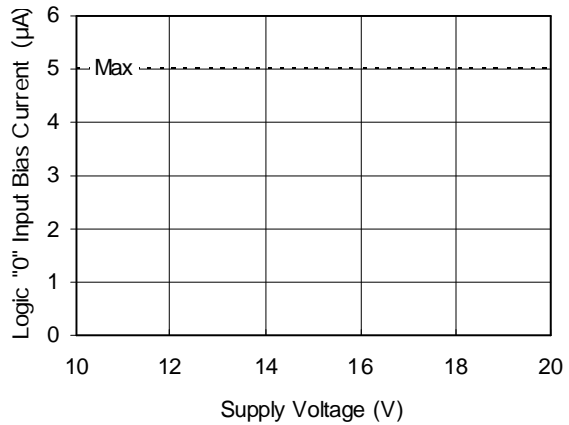

Figure 16B. Logic "0" Input Bias Current vs. Voltage

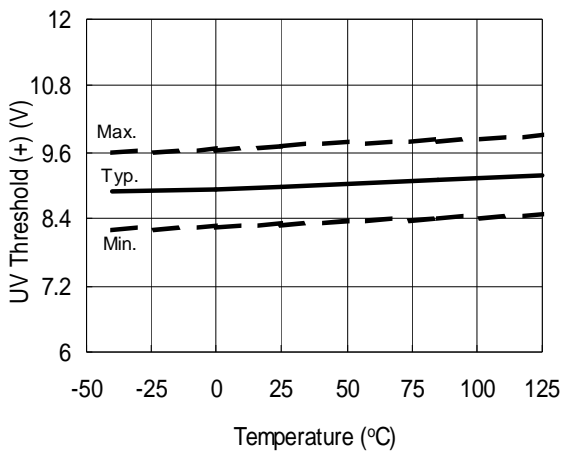

Figure 17. V_{CC} and V_{BS} Undervoltage Threshold (+) vs. Temperature

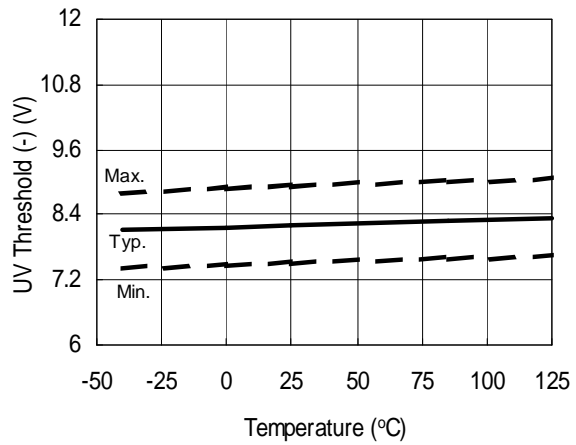

Figure 18. V_{CC} and V_{BS} Undervoltage Threshold (-) vs. Temperature

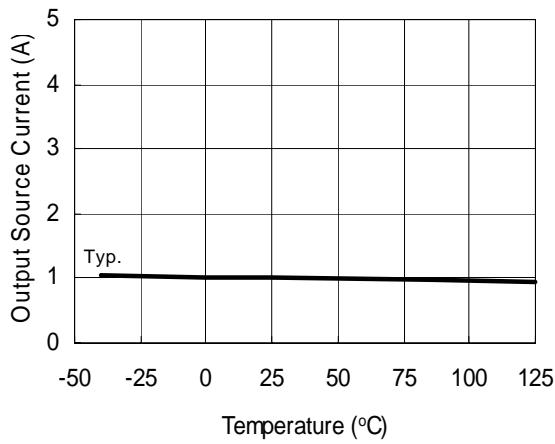

Figure 19A. Output Source Current vs. Temperature

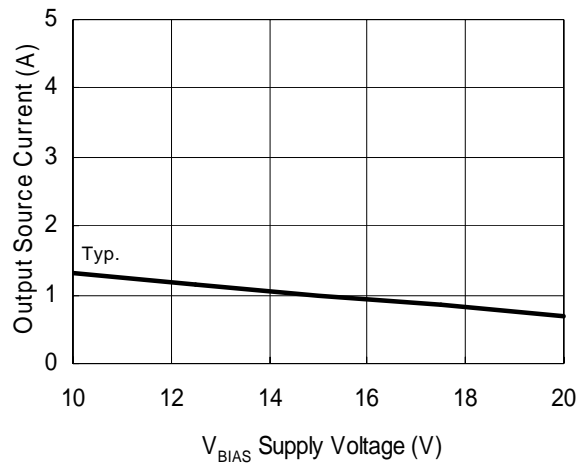

Figure 19B. Output Source Current vs. Supply Voltage

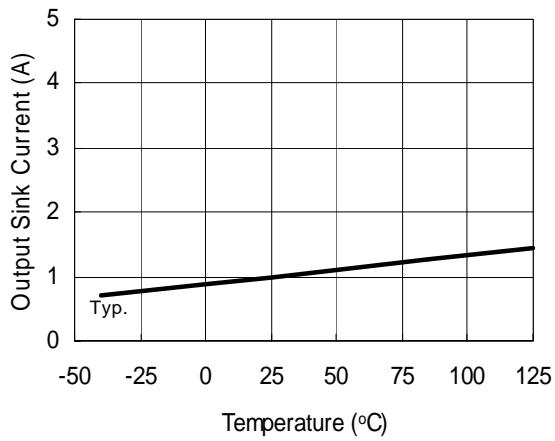

Figure 20A. Output Sink Current vs. Temperature

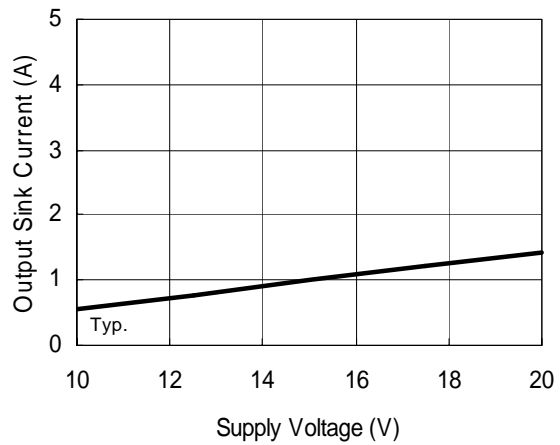

Figure 20B. Output Sink Current vs. Supply Voltage

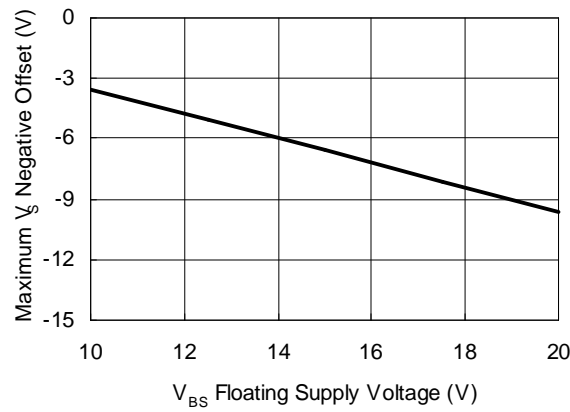

Figure 21. Maximum V_s Negative Offset vs V_{BS} Floating Supply Voltage

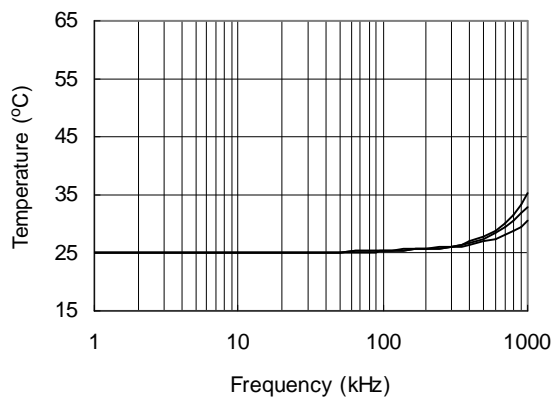

Figure 22. IRS2011S vs. Frequency (IRFBC20)
 $R_{gate}=33\text{ W}$, $V_{CC}=12\text{ V}$

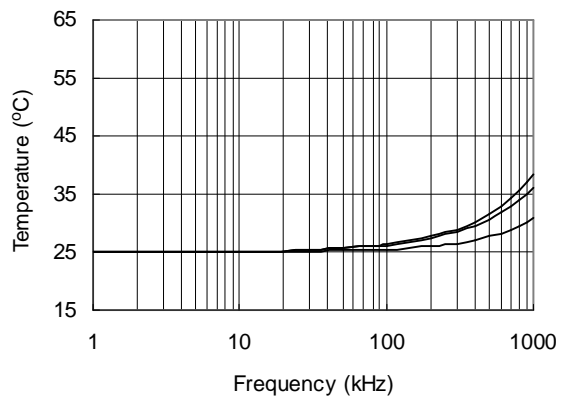

Figure 23. IRS2011S vs. Frequency (IRFBC30)
 $R_{gate}=22\text{ W}$, $V_{CC}=12\text{ V}$

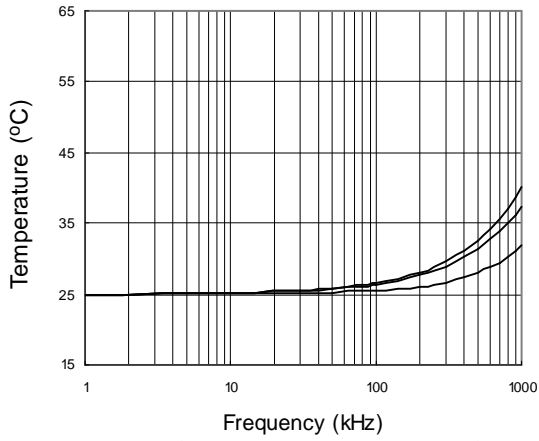

Figure 24. IRS2011S vs. Frequency (IRFBC40)
 $R_{gate}=15\text{ W}, V_{cc}=12\text{ V}$

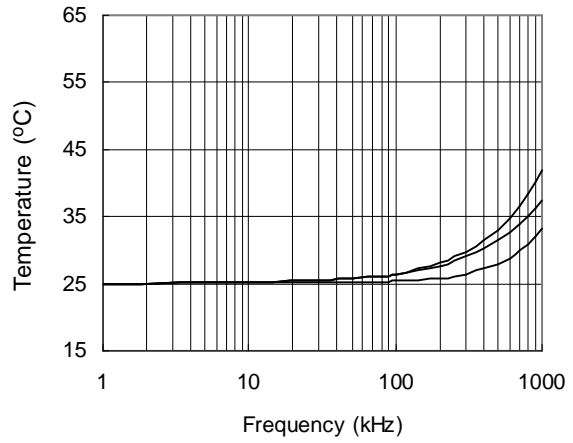

Figure 25. IRS2011S vs. Frequency (IRFB23N15D)
 $R_{gate}=10\text{ W}, V_{cc}=12\text{ V}$

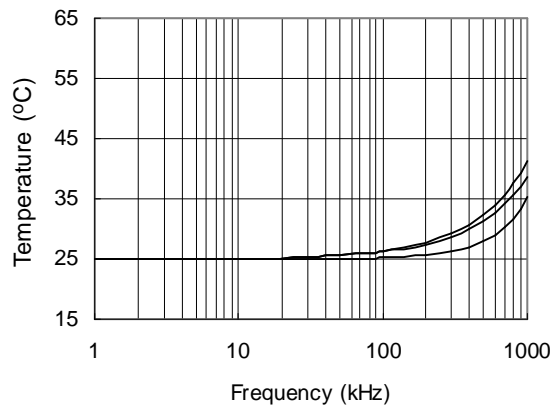
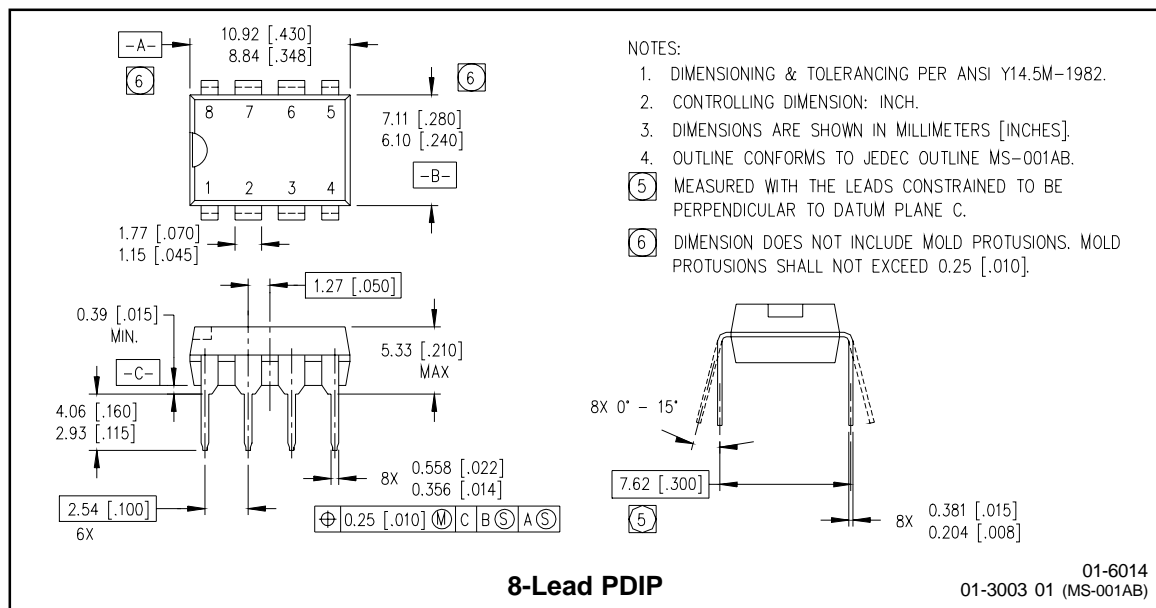
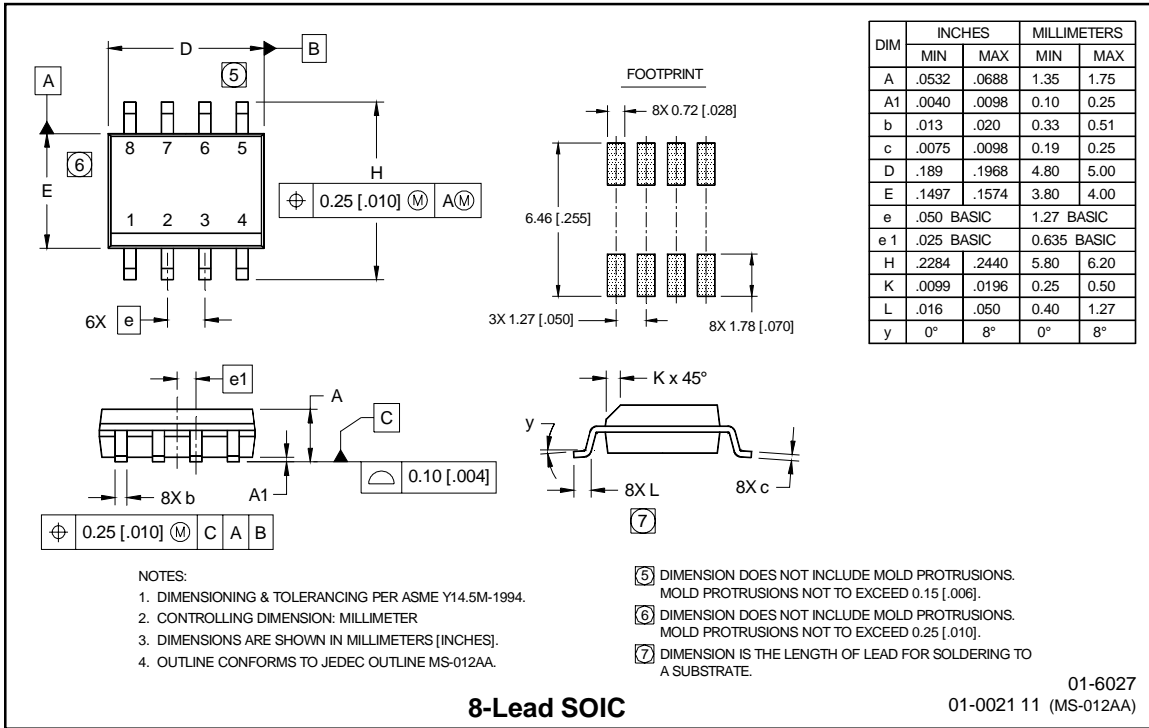
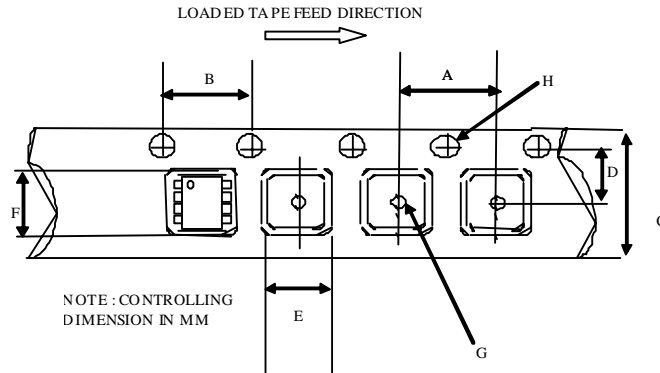

Figure 26. IRS2011S vs. Frequency (IRFB4212)
 $R_{gate}=10\text{ W}, V_{cc}=12\text{ V}$

Case outlines



Tape & Reel 8-lead SOIC



CARRIER TAPE DIMENSION FOR 8SOICN

Code	Metric		Imperial	
	Min	Max	Min	Max
A	7.90	8.10	0.311	0.318
B	3.90	4.10	0.153	0.161
C	11.70	12.30	0.46	0.484
D	5.45	5.55	0.214	0.218
E	6.30	6.50	0.248	0.255
F	5.10	5.30	0.200	0.208
G	1.50	n/a	0.059	n/a
H	1.50	1.60	0.059	0.062

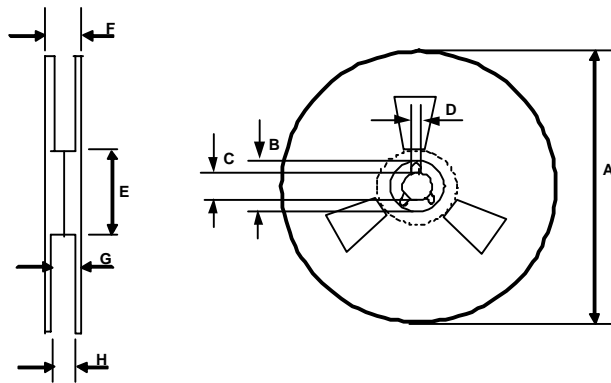

REEL DIMENSIONS FOR 8SOICN

Code	Metric		Imperial	
	Min	Max	Min	Max
A	329.60	330.25	12.976	13.001
B	20.95	21.45	0.824	0.844
C	12.80	13.20	0.503	0.519
D	1.95	2.45	0.767	0.096
E	98.00	102.00	3.858	4.015
F	n/a	18.40	n/a	0.724
G	14.50	17.10	0.570	0.673
H	12.40	14.40	0.488	0.566

LEADFREE PART MARKING INFORMATION

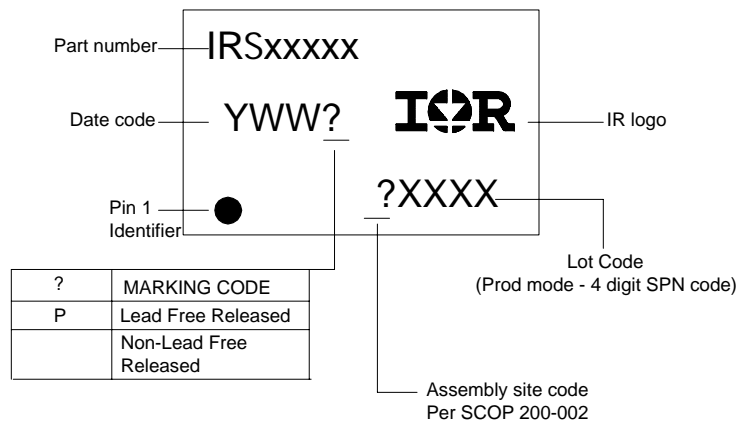

ORDER INFORMATION

- 8-Lead PDIP IRS2011PbF
- 8-Lead SOIC IRS2011SPbF
- 8-Lead SOIC Tape & Reel IRS2011STRPbF