



IR Emitter and Detector Product Data Sheet

HSDL-4251

Spec No.: DS50-2008-0024

Effective Date: 04/30/2013

Revision: A

LITE-ON DCC

RELEASE

BNS-OD-FC001/A4

FEATURES

- * High power AlGaAs LED technology
- * T-1 3/4 Package
- * 870 nm Wavelength
- * High speed: 40ns Rise times
- * Low Forward Voltage
- * Low forward voltage for series operation

- * Applications
- High Speed IR communications
- Portable Infrared Instruments
- Consumer Electronics
- (Optical mouse, Infrared Remote Controllers ect)
- High Speed Infrared Communications
- (IR LANs , IR Moldens , IR Dongles , etc)



PACKAGE DIMENSIONS

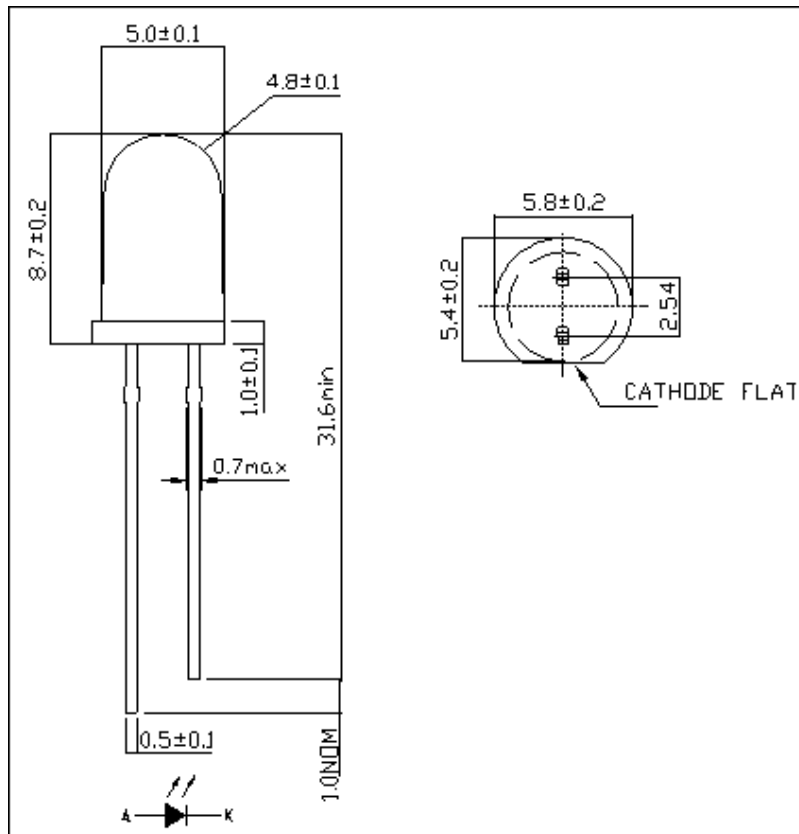

NOTES:

1. All dimensions are in millimeters (inches).
2. Tolerance is $\pm 0.25\text{mm} (.010\text{'})$ unless otherwise noted.
3. Protruded resin under flange is $1.5\text{mm} (.059\text{'})$ max.
4. Lead spacing is measured where the leads emerge from the package.
5. Specifications are subject to change without notice.



LITE-ON TECHNOLOGY CORPORATION.

Property of Lite-On Only

ABSOLUTE MAXIMUM RATINGS AT TA=25°C

PARAMETER	Symbol	MIN	MAX	UNIT	Reference
Forward Current	I _{FDC}		100	mA	[1]
Peak Forward Current	I _{FPK}		500	mA	Fig 3 Duty Factor=20% Pulse Width=100us
Power Dissipation	P _{DISS}		190	mW	
Reverse Voltage	V _R	5		V	I _R =100uA
Storage Temperature	T _S	-40	100	°C	
LED Junction Temperature	T _J		110	°C	
Lead Soldering Temperature [1.6mm(.063") From Body]			260 for 5 seconds	°C	

Notes:

1. Derate as shown in Figure 6.

Recommended Operating Conditions

PARAMETER	Symbol	MIN	MAX	UNIT	Reference
Operating Temperature	T _O	-40	85	°C	



LITE-ON TECHNOLOGY CORPORATION.

Property of Lite-On Only

ELECTRICAL CHARACTERISTICS AT 25°C

PARAMETER	Symbol	MIN.	TYP.	MAX.	UNIT	TEST CONDITION	Reference
Forward Voltage	V_F		1.4	1.6	V	$I_{FDC} = 20\text{mA}$	Fig.2
			1.5	1.9	V	$I_{FDC} = 100\text{mA}$	Fig.3
Forward Voltage Temperature Coefficient	$\Delta V / \Delta T$		-1.44		mV/°C	$I_{FDC} = 100\text{mA}$	Fig.4
Series Resistance	R_S		2.5		0hms	$I_{FDC} = 100\text{mA}$	
Diode Capacitance	C_O		75		pF	0 V, 1 MHz	
Reverse Voltage	V_R	2	20		V	$I_R = 100 \mu A$	
Thermal Resistance, Junction to Pin	$R \theta_{JA}$		300		°C/W		

OPTICAL CHARACTERISTICS AT TA=25°C

PARAMETER	Symbol	MIN.	TYP.	MAX.	UNIT	Test condition	Reference
Radiant On-Axis Intensity	I_E	56	100		Mw/Sr	$I_{FDC} = 100\text{mA}$	Fig.5
Radiant On-Axis Intensity Temperature Coefficient	$\Delta I_E / \Delta T$	-	-0.43	-	%/°C	$I_{FDC} = 100\text{mA}$	
Viewing Angle	$2\theta_{1/2}$	-	30	-	deg	$I_{FDC} = 50\text{mA}$	Fig.7
Peak Wavelength	λ_{pk}	-	870	-	nm	$I_{FDC} = 50\text{mA}$	Fig.1
Peak Wavelength Temperature Coefficient	$\Delta \lambda / \Delta T$	-	0.22	-	nm/°C	$I_{FDC} = 100\text{mA}$	
Spectral Width-at FWHM	$\Delta \lambda$		45	-	nm	$I_{FDC} = 50\text{mA}$	Fig.1
Optical Rise and all Times, 10%-90%	T_r / T_f		40	-	ns	$I_{FDC} = 500\text{ mA}$ Duty Ratio=20% Pulse Width=125ns	

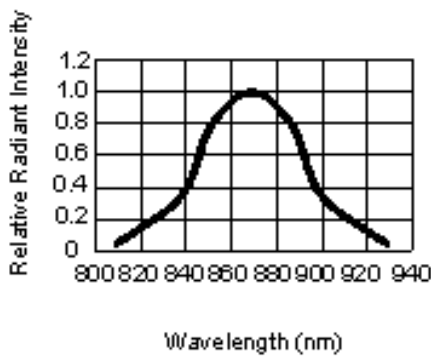

FIG.1 Relative Radiant Intensity VS Wavelength

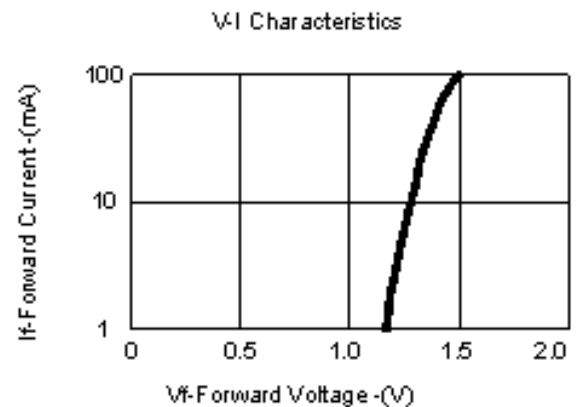

FIG.2 DC Forward Current VS. Forward Voltage

Peak Forward Voltage Vs Peak Forward Current

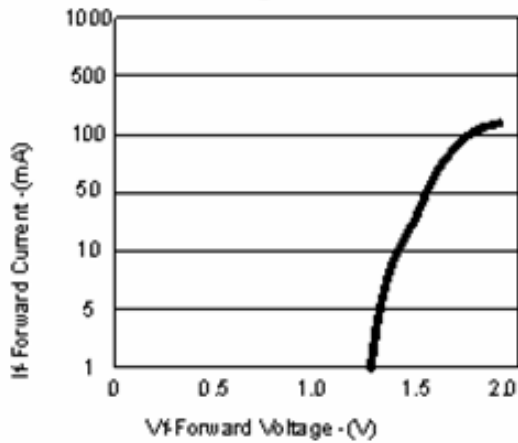

FIG.3 Peak Forward Current VS. Forward Voltage

Forward Current Vs Relative Radiant Intensity

Forward Voltage Vs Temperature

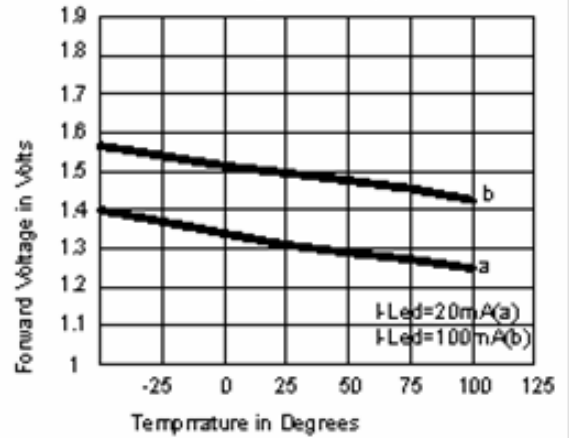

FIG.4 Forward Voltage VS. Ambient Temperature

Forward Current Vs Relative Radiant Intensity

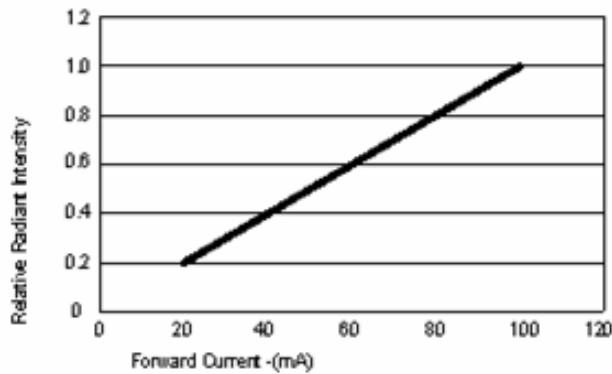

FIG.5 Relative Radiant Intensity vs DC Forward Current

Maximum Permissible DC forward current vs ambient temperature

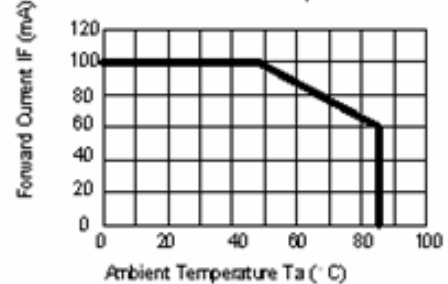

FIG.6 DC FORWARD CURRENT VS. AMBIENT TEMPERATURE DERATED (Based on T_{JMAX}=110°C)

