

**HLMP-3707, HLMP-3907, HLMP-3750, HLMP-3850,
HLMP-3950, HLMP-3960, HLMP-3390, HLMP-3490,
HLMP-3590, HLMP-1340, HLMP-1440, HLMP-1540,
HLMP-K640**

T-13/4 (5 mm), T-1 (3 mm), Ultra-Bright LED Lamps



Data Sheet



Description

These non-diffused lamps out-perform conventional LED lamps. By utilizing new higher intensity material, we achieve superior product performance.

The HLMP-3750/-3390/-1340 Series Lamps are Gallium Arsenide Phosphide on Gallium Phosphide red light emitting diodes. The HLMP-3850/-3490/-1440 Series are Gallium Arsenide Phosphide on Gallium Phosphide yellow light emitting diodes. The HLMP-3950/3590/3960/1540/K640 Series Lamps are Gallium Phosphide green light emitting diodes.

Features

- Improved brightness
- Improved color performance
- Available in popular T-1 and T-1³/₄ packages
- New sturdy leads
- IC compatible/low current capability
- Reliable and rugged
- Choice of 3 bright colors
 - High Efficiency Red
 - High Brightness Yellow
 - High Performance Green

Applications

- Lighted switches
- Backlighting front panels
- Light pipe sources
- Keyboard indicators

Selection Guide

| Package Description | Color | Luminous Intensity Iv (mcd) @ 20mA | | | | 2q1/2 Degree | Package Outline |
|--------------------------------|---------------|------------------------------------|-------|-------|-------|--------------|-----------------|
| | | Device HLMP- | Min. | Typ. | Max. | | |
| T-1 ^{3/4} | Red | 3707-L00xx | 90.2 | - | - | 24 | F |
| | | 3750 | 90.2 | 125.0 | - | 24 | A |
| | | 3750-L00xx | 90.2 | 125.0 | - | 24 | A |
| | Yellow | 3850 | 96.2 | 140.0 | - | 24 | A |
| | | 3850-K00xx | 96.2 | 140.0 | - | 24 | A |
| | | 3850-KL0xx | 96.2 | 150.0 | 294.0 | 24 | A |
| | Green | 3907-K00xx | 111.7 | - | - | 24 | F |
| | | 3914-K00xx | 111.7 | - | - | 24 | D |
| | | 3950 | 111.7 | 265.0 | - | 24 | A |
| 3950-K00xx | | 111.7 | 265.0 | - | 24 | A | |
| 3950-LM0xx | | 170.0 | 300.0 | 490.0 | 24 | A | |
| 3960-K0xxx | | 111.7 | 265.0 | - | 24 | E | |
| T-1 ^{3/4} Low Profile | Red | 3390 | 35.2 | 55.0 | - | 32 | B |
| | Yellow | 3490 | 37.6 | 55.0 | - | 32 | B |
| | Green | 3590 | 43.6 | 55.0 | - | 32 | B |
| T-1 | Red | 1340 | 35.2 | 55.0 | - | 45 | C |
| | | 1340-H00xx | 13.8 | - | - | 45 | C |
| | | 1340-J00xx | 35.2 | 55.0 | - | 45 | C |
| | Yellow | 1440 | 23.5 | 45.0 | - | 45 | C |
| | | 1440-H00xx | 23.5 | 45.0 | - | 45 | C |
| | Green | 1540 | 27.3 | 45.0 | - | 45 | C |
| | | 1540-H00xx | 27.3 | 45.0 | - | 45 | C |
| | | 1540-IJ0xx | 43.6 | 60.0 | 139.6 | 45 | C |
| | Emerald Green | K640 | 4.2 | 21.0 | - | 45 | C |
| K640-FGNxx | | 10.6 | 20.0 | 34.0 | 45 | C | |

Package Dimensions

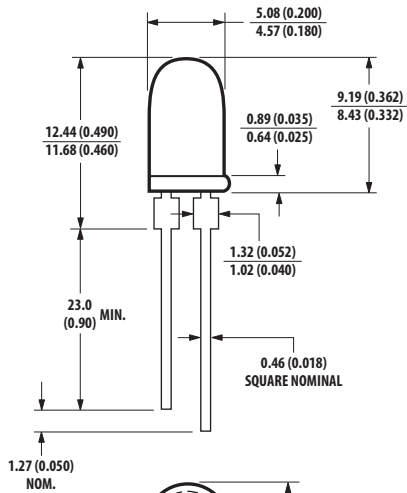

PACKAGE OUTLINE "A"
HLMP-3750/3850/3950

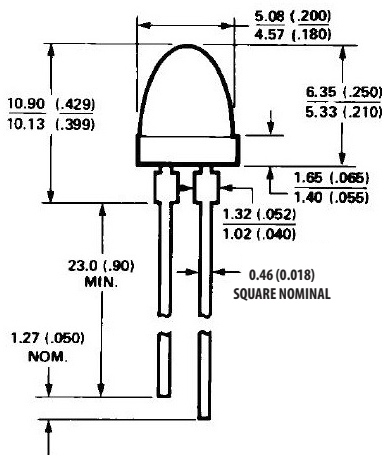

PACKAGE OUTLINE "B"
HLMP-3390/3490/3590

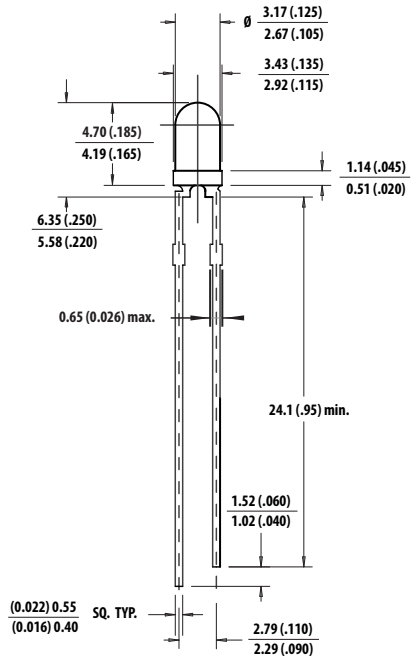

PACKAGE OUTLINE "C"
HLMP-1340/1440/1540

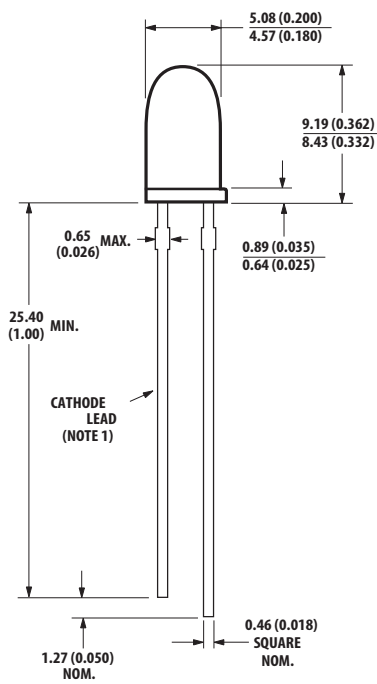

PACKAGE OUTLINE "D"
HLMP-3914

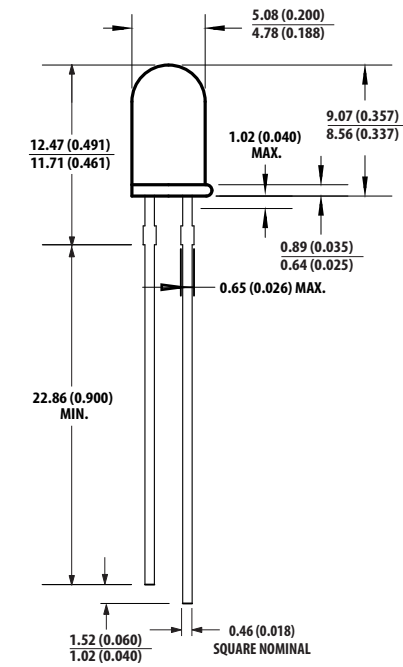

PACKAGE OUTLINE "E"
HLMP-3960

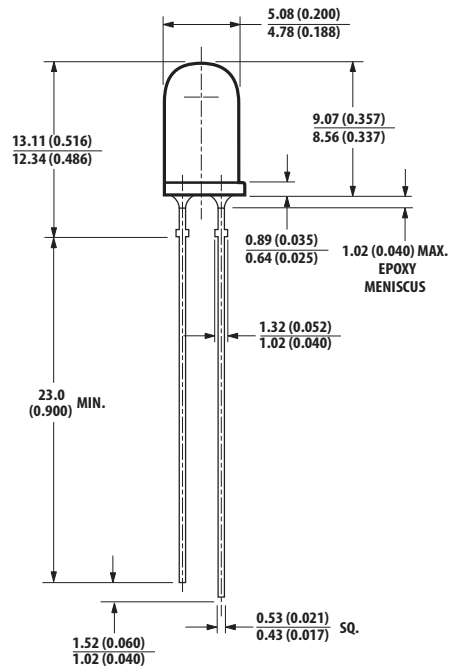

PACKAGE OUTLINE "F"
HLMP-3707/3907

Notes:

1. All dimensions are in millimeters (inches).
2. An epoxy meniscus may extend about 1 mm (0.40") down the leads.
3. For PCB hole recommendations, see the Precautions section.

Part Numbering System

HLMP - x x xx - x x x xx

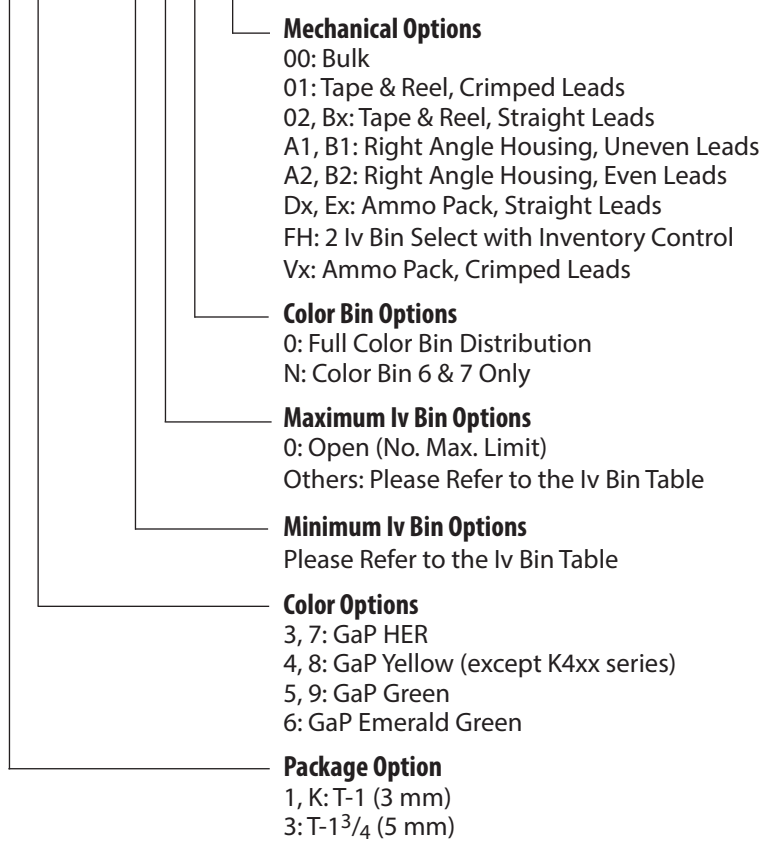

Absolute Maximum Ratings at $T_A = 25^\circ\text{C}$

| Parameter | Red | Yellow | Green/Emerald Green | Units |
|----------------------------------------------------------------------|-------------|-------------|---------------------|------------------|
| Peak Forward Current | 90 | 60 | 90 | mA |
| Average Forward Current ^[1] | 25 | 20 | 25 | mA |
| DC Current ^[2] | 30 | 20 | 30 | mA |
| Transient Forward Current ^[3] (10 μs Pulse) | 500 | 500 | 500 | mA |
| Reverse Voltage ($I_R = 100 \mu\text{A}$) | 5 | 5 | 5 | V |
| LED Junction Temperature | 110 | 110 | 110 | $^\circ\text{C}$ |
| Operating Temperature Range | -40 to +100 | -40 to +100 | -20 to +100 | $^\circ\text{C}$ |
| Storage Temperature Range | -40 to +100 | -40 to +100 | -40 to +100 | $^\circ\text{C}$ |

Notes:

- See Figure 2 to establish pulsed operating conditions.
- For Red and Green series derate linearly from 50°C at $0.5 \text{ mA}/^\circ\text{C}$. For Yellow series derate linearly from 50°C at $0.2 \text{ mA}/^\circ\text{C}$.
- The transient peak current is the maximum non-recurring peak current the devices can withstand without damaging the LED die and wire bonds. It is not recommended that the device be operated at peak currents beyond the Absolute Maximum Peak Forward Current.

Electrical/Optical Characteristics at $T_A = 25^\circ\text{C}$

| Symbol | Description | T-1 ^{3/4} | T-1 ^{3/4} Low Dome | T-1 | Min. | Typ. | Max. | Units | Test Conditions |
|--------------------------|---------------------------|--------------------|--------------------------------|------|------|------|------|-----------------------|-------------------------------------|
| λ_{PEAK} | Peak Wavelength | 37xx | 3390 | 1340 | | 635 | | nm | Measurement at Peak |
| | | 38xx | 3490 | 1440 | | 583 | | | |
| | | 39xx | 3590 | 1540 | | 565 | | | |
| | | | | K640 | | 558 | | | |
| λ_d | Dominant Wavelength | 37xx | 3390 | 1340 | | 626 | | nm | Note 1 |
| | | 38xx | 3490 | 1440 | | 585 | | | |
| | | 39xx | 3590 | 1540 | | 569 | | | |
| | | | | K640 | | 560 | | | |
| $\Delta\lambda^{3/4}$ | Spectral Line Halfwidth | 37xx | 3390 | 1340 | | 40 | | nm | |
| | | 38xx | 3490 | 1440 | | 36 | | | |
| | | 39xx | 3590 | 1540 | | 28 | | | |
| | | | | K640 | | 24 | | | |
| τ_s | Speed of Respond | 37xx | 3390 | 1340 | | 90 | | ns | |
| | | 38xx | 3490 | 1440 | | 90 | | | |
| | | 39xx | 3590 | 1540 | | 500 | | | |
| | | | | K640 | | 3100 | | | |
| C | Capacitance | 37xx | 3390 | 1340 | | 11 | | pF | $V_F = 0,$ $f = 1 \text{ MHz}$ |
| | | 38xx | 3490 | 1440 | | 15 | | | |
| | | 39xx | 3590 | 1540 | | 18 | | | |
| | | | | K640 | | 35 | | | |
| $R\theta_{\text{J-PIN}}$ | Thermal Resistance | 37xx | 3390 | | | 210 | | $^\circ\text{C/W}$ | Junction to Cathode Lead |
| | | 38xx | 3490 | | | 210 | | | |
| | | 39xx | 3590 | | | 210 | | | |
| | | | | | | 510 | | | |
| | | | | | 1340 | 290 | | | |
| | | | | | 1440 | 290 | | | |
| | | | 1540 | 290 | | | | | |
| | | | K640 | 290 | | | | | |
| V_F | Forward Voltage | 37xx | 3390 | 1340 | 1.5 | 1.9 | 2.6 | V | $I_F = 20 \text{ mA}$ (Figure 3) |
| | | 38xx | 3490 | 1440 | 1.5 | 2.1 | 2.6 | | |
| | | 39xx | 3590 | 1540 | 1.5 | 2.2 | 3.0 | | |
| | | | | K640 | | 2.2 | 3.0 | | |
| V_R | Reverse Breakdown Voltage | 37xx | 3390 | 1340 | 5.0 | | | V | $I_F = 100 \mu\text{A}$ |
| | | 38xx | 3490 | 1440 | | | | | |
| | | 39xx | 3590 | 1540 | | | | | |
| | | | | K640 | | | | | |
| η_v | Luminous Efficacy | 37xx | 3390 | 1340 | | 145 | | <u>lumens</u> watt | Note 2 |
| | | 38xx | 3490 | 1440 | | 500 | | | |
| | | 39xx | 3590 | 1540 | | 595 | | | |
| | | | | K640 | | 655 | | | |

Notes:

1. The dominant wavelength, λ_d , is derived from the CIE chromaticity diagram and represents the single wavelength which defines the color of the device.
2. The radiant intensity, I_e , in watts per steradian, may be found from the equation $I_e = IV/\eta_v$, where IV is the luminous intensity in candelas and η_v is the luminous efficacy in lumens/watt.

Red, Yellow, and Green

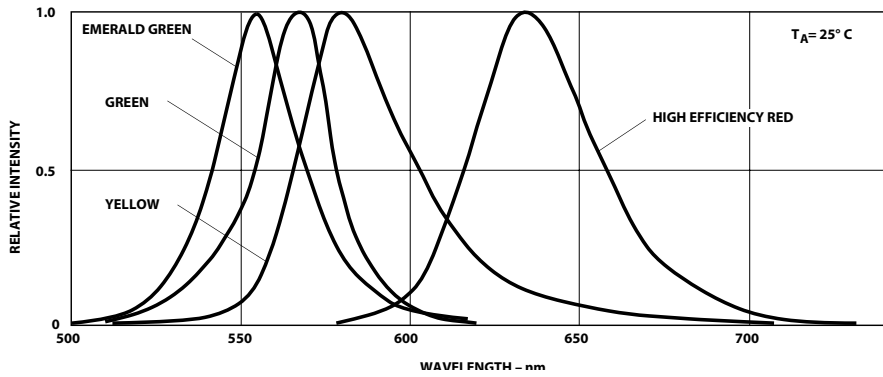

Figure 1. Relative intensity vs. wavelength.

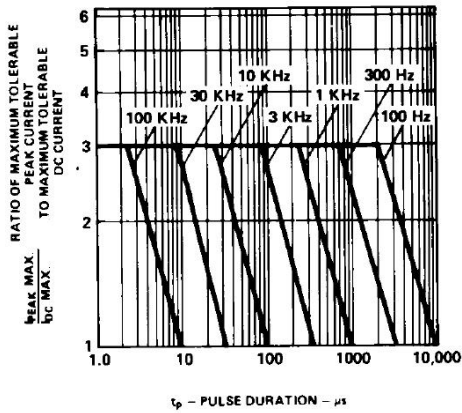

Figure 2. Maximum tolerable peak current vs. pulse duration. ($I_{DC \text{ MAX}}$ as per MAX ratings).

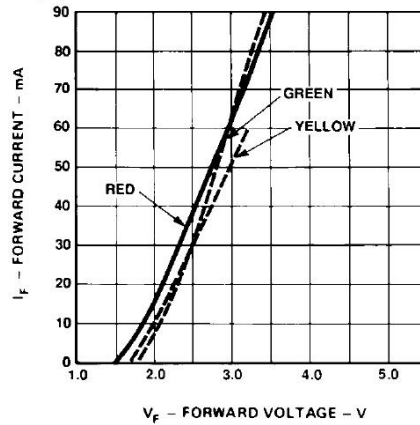

Figure 3. Forward current vs. forward voltage.

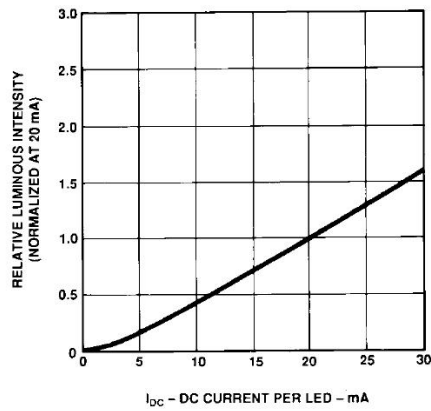

Figure 4. Relative luminous intensity vs. forward current.

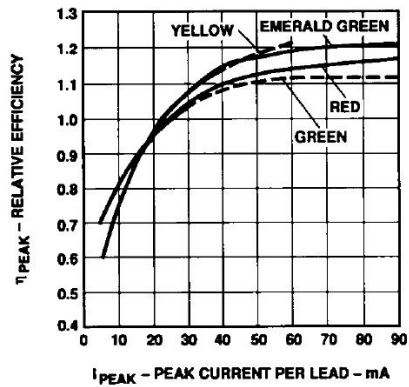

Figure 5. Relative efficiency (luminous intensity per unit current) vs. peak current.

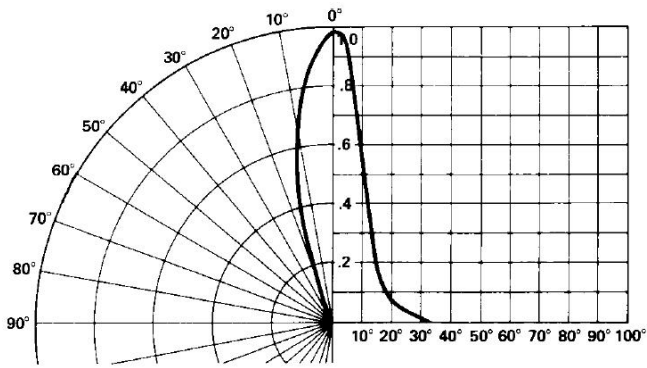

Figure 6. Relative luminous intensity vs. angular displacement.
T-1^{3/4} lamp.

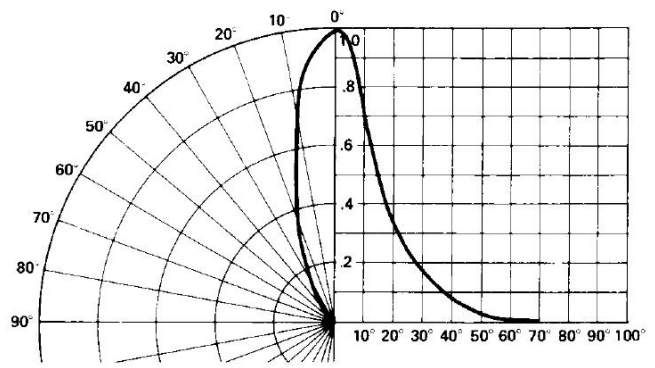

Figure 7. Relative luminous intensity vs. angular displacement.
T-1^{3/4} low profile lamp.

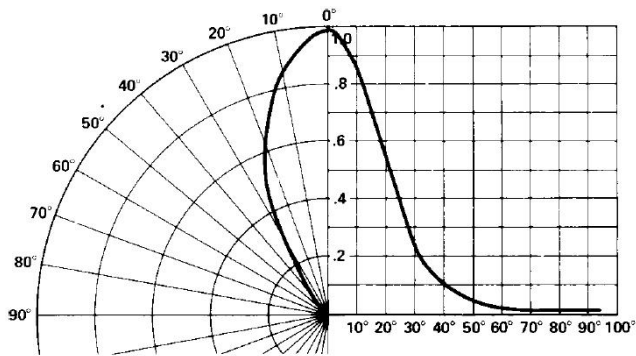

Figure 8. Relative luminous intensity vs. angular displacement.
T-1 lamp.

Intensity Bin Limits

| Color | Bin | Intensity Range (mcd) | |
|-------|---------|-----------------------|--------|
| | | Min. | Max. |
| Red | G | 9.7 | 15.5 |
| | H | 15.5 | 24.8 |
| | I | 24.8 | 39.6 |
| | J | 39.6 | 63.4 |
| | K | 63.4 | 101.5 |
| | L | 101.5 | 162.4 |
| | M | 162.4 | 234.6 |
| | N | 234.6 | 340.0 |
| | O | 340.0 | 540.0 |
| | P | 540.0 | 850.0 |
| | Q | 850.0 | 1200.0 |
| | R | 1200.0 | 1700.0 |
| | S | 1700.0 | 2400.0 |
| | T | 2400.0 | 3400.0 |
| U | 3400.0 | 4900.0 | |
| V | 4900.0 | 7100.0 | |
| W | 7100.0 | 10200.0 | |
| X | 10200.0 | 14800.0 | |
| Y | 14800.0 | 21400.0 | |
| Z | 21400.0 | 30900.0 | |

Maximum tolerance for each bin limit is $\pm 18\%$.

Intensity Bin Limits (continued)

| Color | Bin | Intensity Range (mcd) | |
|-------------------|---------|-----------------------|---------|
| | | Min. | Max. |
| Yellow | F | 10.3 | 16.6 |
| | G | 16.6 | 26.5 |
| | H | 26.5 | 42.3 |
| | I | 42.3 | 67.7 |
| | J | 67.7 | 108.2 |
| | K | 108.2 | 173.2 |
| | L | 173.2 | 250.0 |
| | M | 250.0 | 360.0 |
| | N | 360.0 | 510.0 |
| | O | 510.0 | 800.0 |
| | P | 800.0 | 1250.0 |
| | Q | 1250.0 | 1800.0 |
| | R | 1800.0 | 2900.0 |
| | S | 2900.0 | 4700.0 |
| | T | 4700.0 | 7200.0 |
| | U | 7200.0 | 11700.0 |
| | V | 11700.0 | 18000.0 |
| W | 18000.0 | 27000.0 | |
| Green/ Emerald | A | 1.1 | 1.8 |
| Green | B | 1.8 | 2.9 |
| | C | 2.9 | 4.7 |
| | D | 4.7 | 7.6 |
| | E | 7.6 | 12.0 |
| | F | 12.0 | 19.1 |
| | G | 19.1 | 30.7 |
| | H | 30.7 | 49.1 |
| | I | 49.1 | 78.5 |
| | J | 78.5 | 125.7 |
| | K | 125.7 | 201.1 |
| | L | 201.1 | 289.0 |
| | M | 289.0 | 417.0 |
| | N | 417.0 | 680.0 |
| | O | 680.0 | 1100.0 |
| | P | 1100.0 | 1800.0 |
| | Q | 1800.0 | 2700.0 |
| | R | 2700.0 | 4300.0 |
| S | 4300.0 | 6800.0 | |
| T | 6800.0 | 10800.0 | |
| U | 10800.0 | 16000.0 | |
| V | 16000.0 | 25000.0 | |
| W | 25000.0 | 40000.0 | |

Maximum tolerance for each bin limit is $\pm 18\%$.

Color Categories

| Color | Cat # | Lambda (nm) | |
|---------------|-------|-------------|-------|
| | | Min. | Max. |
| Emerald Green | 9 | 552.5 | 555.5 |
| | 8 | 555.5 | 558.5 |
| | 7 | 558.5 | 561.5 |
| | 6 | 561.5 | 564.5 |
| Green | 6 | 561.5 | 564.5 |
| | 5 | 564.5 | 567.5 |
| | 4 | 567.5 | 570.5 |
| | 3 | 570.5 | 573.5 |
| Yellow | 2 | 573.5 | 576.5 |
| | 1 | 582.0 | 584.5 |
| | 3 | 584.5 | 587.0 |
| | 2 | 587.0 | 589.5 |
| Orange | 4 | 589.5 | 592.0 |
| | 5 | 592.0 | 593.0 |
| | 1 | 597.0 | 599.5 |
| | 2 | 599.5 | 602.0 |
| | 3 | 602.0 | 604.5 |
| | 4 | 604.5 | 607.5 |
| | 5 | 607.5 | 610.5 |
| | 6 | 610.5 | 613.5 |
| | 7 | 613.5 | 616.5 |
| | 8 | 616.5 | 619.5 |

Maximum tolerance for each bin limit is ± 0.5 nm.

Mechanical Option Matrix

| Mechanical Option Code | Definition |
|------------------------|--------------------------------------------------------------------------------------------------------|
| 00 | Bulk Packaging, minimum increment 500 pcs/bag |
| 01 | Tape & Reel, crimped leads, min. increment 1300 pcs/bag for T-1 ^{3/4} , 1800 pcs/bag for T-1 |
| 02 | Tape & Reel, straight leads, min. increment 1300 pcs/bag for T-1 ^{3/4} , 1800 pcs/bag for T-1 |
| A1 | T-1, Right Angle Housing, uneven leads, minimum increment 500 pcs/bag |
| A2 | T-1, Right Angle Housing, even leads, minimum increment 500 psc/bag |
| B1 | T-1 ^{3/4} , Right Angle Housing, uneven leads, minimum increment 500 pcs/bag |
| B2 | T-1 ^{3/4} , Right Angle Housing, even leads, minimum increment 500 psc/bag |
| BJ | T-1, Tape & Reel, straight leads, minimum increment 2000 pcs/bag |
| EG | Ammo Pack, straight leads in 5 K increment |
| FH | Devices that require inventory control and 2 I _v bin select |
| VR | Ammo Pack, crimped leads, min. increment 2 k for T-1 ^{3/4} and T-1 |

Note:

All categories are established for classification of products. Products may not be available in all categories. Please contact your local Avago representative for further clarification/information.

Precautions:

Lead Forming:

- The leads of an LED lamp may be preformed or cut to length prior to insertion and soldering on PC board.
- For better control, it is recommended to use proper tool to precisely form and cut the leads to applicable length rather than doing it manually.
- If manual lead cutting is necessary, cut the leads after the soldering process. The solder connection forms a mechanical ground which prevents mechanical stress due to lead cutting from traveling into LED package. This is highly recommended for hand solder operation, as the excess lead length also acts as small heat sink.

Soldering and Handling:

- Care must be taken during PCB assembly and soldering process to prevent damage to the LED component.
- LED component may be effectively hand soldered to PCB. However, it is only recommended under unavoidable circumstances such as rework. The closest manual soldering distance of the soldering heat source (soldering iron's tip) to the body is 1.59mm. Soldering the LED using soldering iron tip closer than 1.59mm might damage the LED.

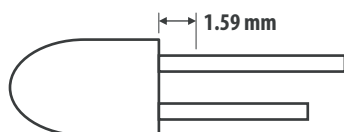

- ESD precaution must be properly applied on the soldering station and by personnel to prevent ESD damage to the LED component that is ESD sensitive. For details, refer to Avago application note AN 1142. The soldering iron used should have a grounded tip to ensure electrostatic charge is properly grounded.
- Recommended soldering conditions:

| | Wave Soldering ^{[1],[2]} | Manual Solder Dipping |
|----------------------|-----------------------------------|-----------------------|
| Pre-heat Temperature | 105°C Max. | – |
| Pre-heat Time | 60 sec Max. | – |
| Peak Temperature | 250°C Max. | 260°C Max. |
| Dwell Time | 3 sec Max. | 5 sec Max. |

Notes:

1. These conditions refer to measurement with a thermocouple mounted at the bottom of PCB.
2. To reduce thermal stress experienced by the LED, it is recommended that you use only the bottom preheaters.

- Wave soldering parameters must be set and maintained according to the recommended temperature and dwell time. Customer is advised to perform daily check on the soldering profile to ensure that it is always conforming to recommended soldering conditions.

Note:

1. PCB with different size and design (component density) will have different heat mass (heat capacity). This might cause a change in temperature experienced by the board if same wave soldering setting is used. So, it is recommended to re-calibrate the soldering profile again before loading a new type of PCB.
 2. Customer is advised to take extra precaution during wave soldering to ensure that the maximum wave temperature does not exceed 250°C and the solder contact time does not exceeding 3sec. Over-stressing the LED during soldering process might cause premature failure to the LED due to delamination.
- Any alignment fixture that is being applied during wave soldering should be loosely fitted and should not apply weight or force on LED. Non metal material is recommended as it will absorb less heat during wave soldering process.
 - At elevated temperature, LED is more susceptible to mechanical stress. Therefore, PCB must allowed to cool down to room temperature prior to handling, which includes removal of alignment fixture or pallet.
 - If PCB board contains both through hole (TH) LED and other surface mount components, it is recommended that surface mount components be soldered on the top side of the PCB. If surface mount need to be on the bottom side, these components should be soldered using reflow soldering prior to insertion the TH LED.
 - Recommended PC board plated through holes (PTH) size for LED component leads:

| | LED Component Lead Size | Diagonal | Plated Through-Hole Diameter |
|------------------------------|---------------------------------------|------------------------|----------------------------------------|
| Lead size (typ.) | 0.45 × 0.45 mm (0.018 × 0.018 in.) | 0.636 mm (0.025 in) | 0.98 to 1.08 mm (0.039 to 0.043 in) |
| Dambar shear-off area (max.) | 0.65 mm (0.026 in) | 0.919 mm (0.036 in) | |
| Lead size (typ.) | 0.50 × 0.50 mm (0.020 × 0.020 in.) | 0.707 mm (0.028 in) | 1.05 to 1.15 mm (0.041 to 0.045 in) |
| Dambar shear-off area (max.) | 0.70 mm (0.028 in) | 0.99 mm (0.039 in) | |

- Over-sizing the PTH can lead to a twisted LED after it is clinched. On the other hand, undersizing the PTH can make inserting the TH LED difficult.

For more information about soldering and handling of TH LED lamps, refer to application note AN5334.

Example of Wave Soldering Temperature Profile for TH LED

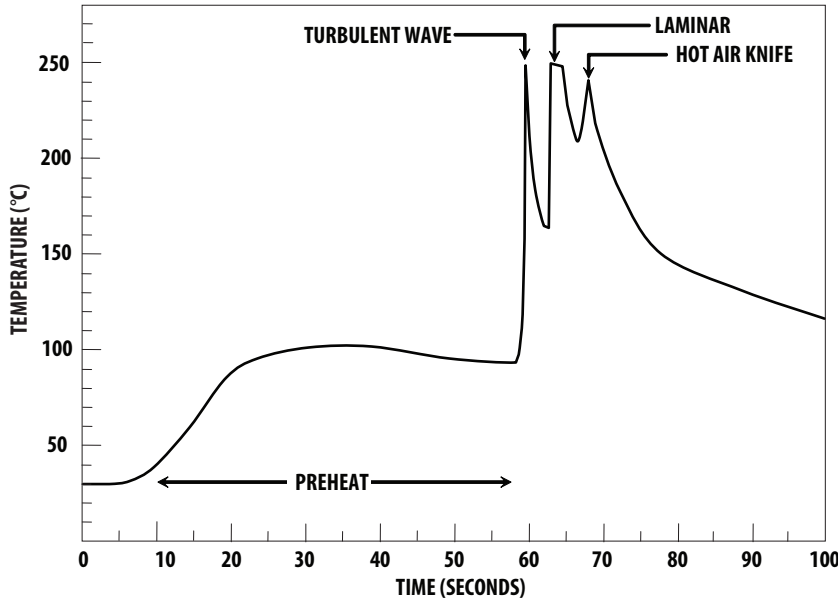

Recommended solder:
 Sn63 (Leaded solder alloy)
 SAC305 (Lead free solder alloy)

Flux: Rosin flux

Solder bath temperature:
 245°C ± 5°C (maximum peak temperature = 250°C)

Dwell time: 1.5 sec – 3.0 sec (maximum = 3sec)

Note: Allow for board to be sufficiently cooled to room temperature before exerting mechanical force.

Recommended solder:
 Sn63 (Leaded solder alloy)
 SAC305 (Lead free solder alloy)

Flux: Rosin flux

Solder bath temperature:
 245°C ± 5°C (maximum peak temperature = 250°C)

Dwell time: 1.5 sec – 3.0 sec (maximum = 3sec)











Note: Allow for board to be sufficiently cooled to room temperature before exerting mechanical force.

Packaging Label:

(i) Avago Mother Label: (Available on packaging box of ammo pack and shipping box)

| | |
|-----------------------------------------------|-------------------------------------------------------------|
| AVAGO TECHNOLOGIES | |
| (1P) Item: Part Number [Barcode] | STANDARD LABEL LS0002 RoHS Compliant e3 max temp 250C |
| (1T) Lot: Lot Number [Barcode] | (Q) QTY: Quantity [Barcode] |
| LPN: [Barcode] | CAT: Intensity Bin [Barcode] |
| (9D)MFG Date: Manufacturing Date [Barcode] | BIN: Color Bin |
| <hr/> | |
| (P) Customer Item: [Barcode] | |
| (V) Vendor ID: [Barcode] | (9D) Date Code: Date Code [Barcode] |
| <hr/> | |
| DeptID: [Barcode] | Made In: Country of Origin [Barcode] |

(ii) Avago Baby Label (Only available on bulk packaging)

| | |
|-----------------------------------------------------------------------------------|----------------------------|
|  | |
| Lamps Baby Label | |
| RoHS Compliant e3 max temp 250C | |
| (1P) PART #: Part Number | |
|  | |
| (1T) LOT #: Lot Number | |
|  | |
| (9D)MFG DATE: Manufacturing Date | QUANTITY: Packing Quantity |
|  | |
|  | |
| C/O: Country of Origin | |
| Customer P/N: | CAT: Intensity Bin |
|  | |
|  | |
| Supplier Code: | BIN: Color Bin |
|  | |
|  | |
| | DATECODE: Date Code |
|  | |

For product information and a complete list of distributors, please go to our web site: www.avagotech.com

Avago, Avago Technologies, and the A logo are trademarks of Avago Technologies in the United States and other countries.
Data subject to change. Copyright © 2005-2014 Avago Technologies. All rights reserved. Obsoletes 5989-4254EN
AV02-1556EN - July 24, 2014

