



Huizhou Wisva Optoelectronics Co.,Ltd

惠州市慧昊光电有限公司

Add: 5 Floor, Building 6, science and Technology Park, Longhai three road, Huiyang District, Huizhou China  
地址: 惠州市惠阳区龙海三路中海科技园6栋5楼  
Tel/Tel: 0752-5288039 Web: http://www.wisvaled.com

# Product Specification

产品规格书

Item No.:

HH-SX180F010W24-2835

产品型号:

Series: High Efficiency Series

产品系列: 高光效系列

| Confirmation/制作 | Approval/审核 | Audit/确认 | Date/日期    | Version/版本 |
|-----------------|-------------|----------|------------|------------|
|                 |             |          | 2021/12/14 | 2.0        |



## Specifications(参数)

|                              |                            |       |            |       |       |            |
|------------------------------|----------------------------|-------|------------|-------|-------|------------|
| Item NO.<br>产品型号             | HH-SX180F010W24-2835       |       |            |       |       |            |
| Light Source<br>使用光源         | 2835                       |       |            |       |       |            |
| LED Qty/M<br>LED灯数/米         | 180                        |       |            |       |       |            |
| Input Voltage<br>输入电压        | 24VDC                      |       |            |       |       |            |
| PCB<br>板子                    | 10mm/2oz                   |       |            |       |       |            |
| Length<br>长度                 | 5,000 mm                   |       |            |       |       |            |
| Size<br>尺寸                   | Width: 10mm, Height: 1.2mm |       |            |       |       |            |
| Cutting Length<br>裁剪长度       | 50mm                       |       |            |       |       |            |
| Lifespan<br>工作时长             | 50,000 H                   |       |            |       |       |            |
| Working Temperature<br>工作温度  | -20°C - 40°C               |       |            |       |       |            |
| Storage Temperature<br>储存温度  | -20°C - 45°C               |       |            |       |       |            |
| Warranty<br>质保               | 3 YEARS                    |       |            |       |       |            |
| Power<br>功率                  | 8W/m                       |       |            |       |       |            |
| Ra<br>显色指数                   | 80+                        |       |            | 90+   |       |            |
| CCT<br>色温                    | 2700K                      | 3000K | 4000-6000K | 2700K | 3000K | 4000-6000K |
| Brightness(Lm)<br>亮度(流明)     | 1360                       | 1440  | 1600       | 1080  | 1160  | 1280       |
| Efficiency(Lm/W)<br>光效(流明/瓦) | 170                        | 180   | 200        | 135   | 145   | 160        |
| Installation Length<br>安装长度  | 4m                         |       |            |       |       |            |

\* The above measurements of watts, brightness and efficiency allowance tolerance  $\pm 10\%$ .

\* 以上功率和光效允许误差范围是 $\pm 10\%$ .

\* The above measurements are based on IP20.

以上测量均基于IP20.

## Brightness Curve(亮度曲线)

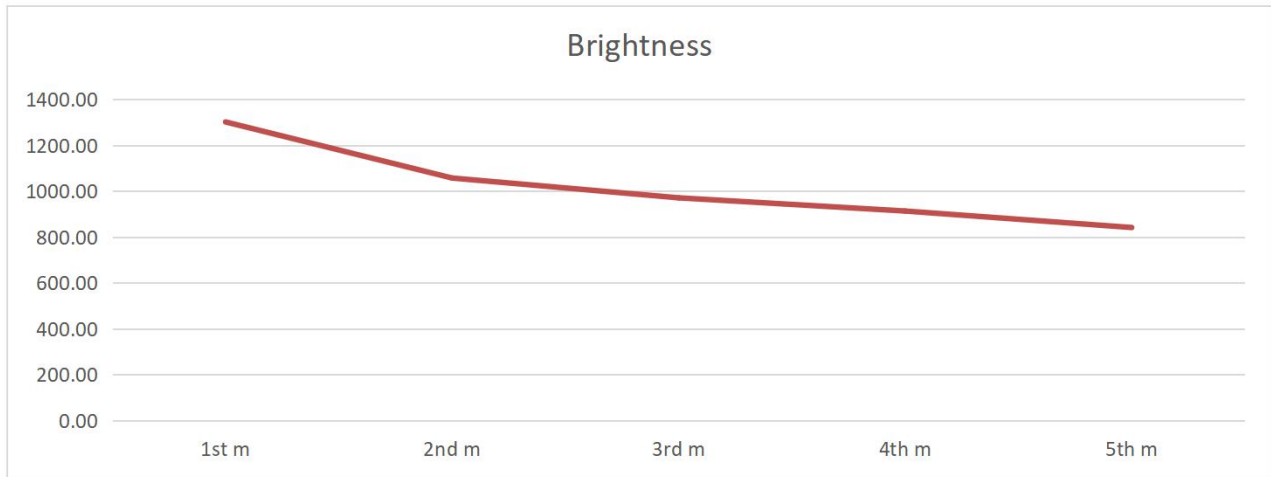

| Length  | 1st m   | 2nd m   | 3rd m   | 4th m   | 5th m  |
|---------|---------|---------|---------|---------|--------|
| Volage  | 23.86   | 23.69   | 23.63   | 23.59   | 23.54  |
| Lumen   | 1301.29 | 1056.85 | 970.58  | 913.06  | 841.17 |
| Dropped | 0.00%   | -18.78% | -25.41% | -29.83% | #####  |

\* The above chart shows the voltage drop and brightness difference in 5 meters.

以上图表显示5米内的压降和亮度差。

\* Normally, we recommend brightness drop within 30%, so the recommend connecting length is 4m.

一般情况下,我们建议首位亮度差维持在30%以内, 所以该产品推荐的连接长度为4米.

## Temp. Curve(温度曲线)

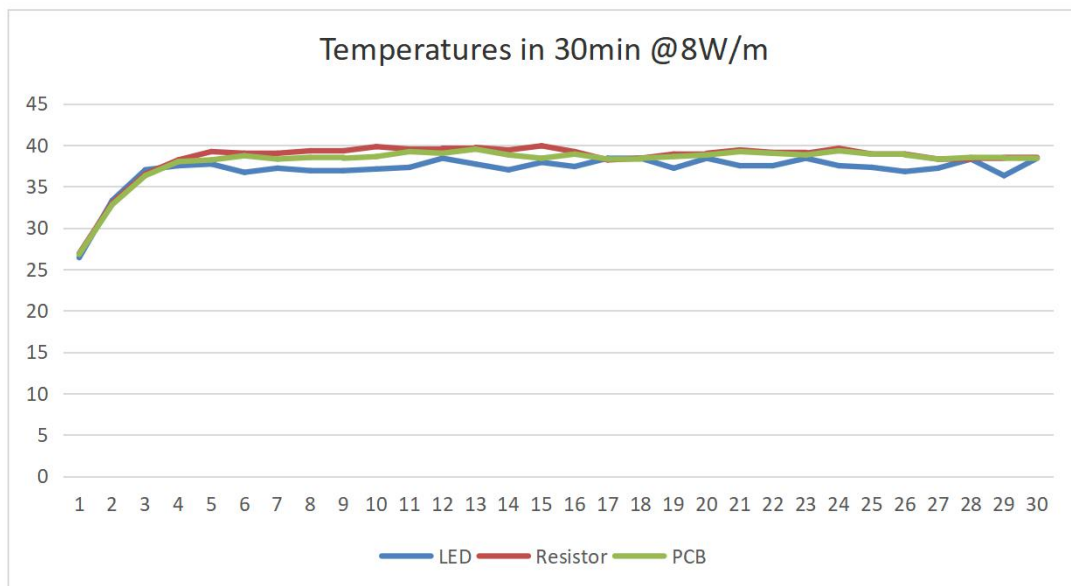

\* The above curve indicates the change of temperature after powering on 30 minutes.





\* 以上的温升图基于通电后30分钟的测试数据。

\* The y-axis indicates the changes of temperatures on LED surface, PCB, and Resistor at TC25°C.

\* Y轴表示焊盘, 灯珠表面, PCB, 以及电阻在室温25°C下的温度变化。

## Waterproof Ways(防水方式)

Available waterproof ways:

| Waterproof Ways   | IP Rating | Details   |
|---|-----------|---|
| 防水方式  | 防水等级      | 细节说明  |
|  | IP54      | PU or Silicone glue on the surface of the led strips.<br>表面滴PU或者硅胶                                    |
|  | IP65      | Heat Shrink tube or Silicone tube for led strips.<br>热缩套管或者硅胶套管防水                                     |
|  | IP67      | Hollow integrated silicone glue.<br>挤出型硅胶防水, 中空   |
|  | IP68      | Solid Integrated Silicone glue, or silicone glue with silicone tube<br>挤出型一体化硅胶防水, 实心; 或者灌胶(硅胶套管里加硅胶) |

## Installation Ways(安装方式)

Install the LED strip within the Max Length which specified in the specification, for installing more than Max Length, please connect them in parallel.

根据规格书上声明的最大长度去安装, 如果安装长度超过最大长度, 请采用并联的方式.

Usually most of the power supply has a efficiency between 80%-95%, so when choosing the power supply, the total watts of the strips should be smaller than 80% of the rate power of the Power Supply.

通常大部分电源的输出效率大概在80%-95%, 所以当选择电源时, 应注意灯带的输出功率必须小于电源额定功率的80%.

Only powered by 24Vdc, do not use other power source to power the LED strip.

只接受24Vdc供电, 不能使用其他类型的电源供电.

### Wiring Diagram(接线图)

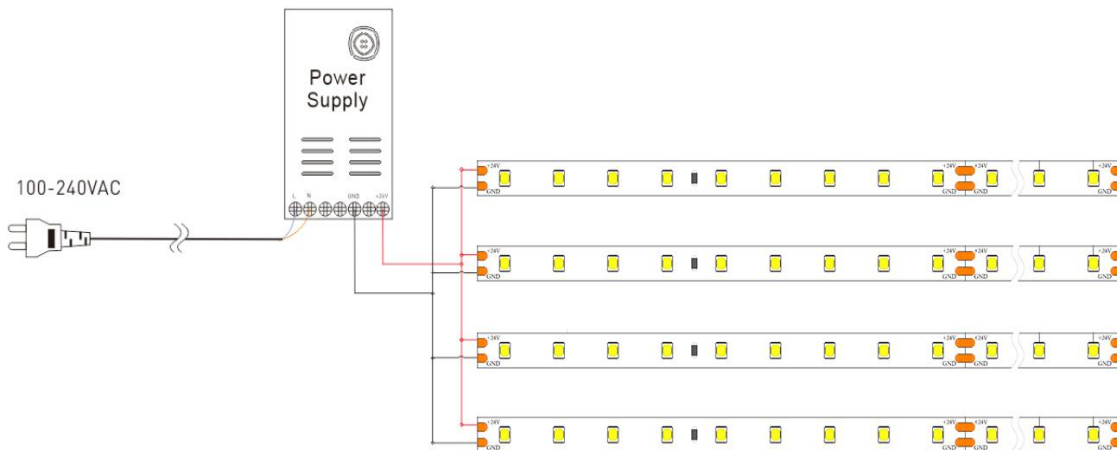

## Applications(应用)

\* Used in linear lights as lighting source; used for indoor decorations.  
作为线条灯条光源，用作室内室外的照明。

## Package(包装)

①) 5 meters per roll.

5m一卷。

②) Each roll packed with anti-static bags, and label on it.

每一卷放入静电袋中，静电袋表面贴标签。

③) 25 rolls into a small box.

25卷放入一个小箱子中。

④-⑤) 2 small boxes into a large carton 520\*320\*300mm.

2个小箱放入一个大箱。

⑥) Delivery.

发货。

