

KEMET Part Number: ESD-SR-S47M
(UECESDSRS47M00)

KEMET, ESD-SR, EMI Cores, Noise Suppression

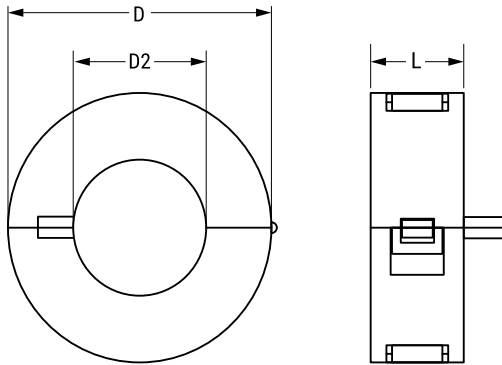

General Information	
Series:	ESD-SR
Style:	Round - Snap-on
Cable Type:	Round Cable
Description:	EMI Core Split, For Round Cables, Snap-on Core
RoHS:	Yes
Qualifications:	UL94V-0
Case Color:	Black
Materials:	Mn-Zn

Dimensions	
D	53mm +/-1mm
D2	26mm MAX
L	19mm +/-1mm

Specifications	
Temperature Range:	-40/+85°C
Effective Frequency:	10 MHz (AM Band Range)

Packaging Specifications	
Packaging:	Tray, Box
Packaging Quantity:	72
Weight:	89 g