

Industries & Applications



Automation

Industrial

Semi-Fab

Renewable

Comms

Test

ePLAN
data portal

Features & Benefits

- ▶ **Wide 3 phase input range** for various AC power systems
- ▶ **Parallel mode switch** to activate load balancing behaviour
- ▶ **Two means of transient protection** increase process stability
- ▶ **Fast OVP control** protects sensitive loads
- ▶ **Very low inrush energy peak (I²t)** saves cost for input line protection
- ▶ **Screw or push-in terminals available** to serve individual application needs
- ▶ **High efficiency and low stand-by losses contribute to an eco-friendly energy footprint**
- ▶ **DC-OK and inhibit relay contacts** for professional integration into applications control architecture
- ▶ **Comprehensive boost power capabilities** support start-up into capacitive loads and increase system design flexibility
- ▶ Designed to meet the 7 most accepted IEC safety standards
- ▶ Exceeds regulatory EMC standards on radiated emission (Class B), surge immunity and fast transients



Technical data abstract¹

Output voltage	nom.	24V _{Dc}
Adjustment range	nom.	22.5 .. 29V _{Dc}
Output current	nom.	20A
Boost current 1 ⁴	max.	30A / 5s
Boost current 2 ⁴	max.	30A / 7s
Overload behaviour		CC + Intermittent mode (Hiccup)
Hold-up time	min.	24ms
Frequency range	max.	47 .. 63Hz
AC input voltage	nom.	3x400 .. 500V _{AC}
AC input voltage range	max.	3x350 .. 575V _{AC}
Inrush current ²	typ.	17 / 22A <200μs
Inrush energy ²	typ.	0.04 / 0.05A ² s
Output power	nom.	480W
Boost power 1 ⁴	max.	720W / 5s
Boost power 2 ⁴	max.	720W / 7s
Power factor	typ.	0.92
Conversion efficiency ²	typ.	95.1 / 94.9%
Power losses ²	typ.	24.7 / 25.8W
No-load consumption ²	max.	3.0 / 3.2W
Ambient operating temperature	max.	-25 .. +70°C (-13 .. +158°F)
	nom.	-25 .. +55°C (-13 .. +131°F)
Service lifetime ²	min.	148 000 / 124 000hrs
Service life MTBF ³	min.	4.40M / 0.86M hrs
Width		65mm (2 ⁹ / ₁₆ in)
Height		129mm (5 ⁵ / ₁₆ in)
Depth		159.3mm (6 ¹⁷ / ₆₄ in)
Weight		1050g (2.32lb)

¹All values refer to STC unless otherwise stated | ²400 / 500V_{AC} | ³50% / 100% P_{out,nom} |

⁴See duty cycle 1/2 under „4. Performance“ on page 9

Certifications & Approvals



IEC EN 61010-1
IEC EN 61010-2-201
IEC EN 62368-1 (Ed.2)



UL CSA 61010-1
UL CSA 61010-2-201
E356563



UL CSA 62368-1 (Ed.2)
E511889

Compliance & Registration



EU Low Voltage Dir. 2014/35/EU
EU EMC Dir. 2014/30/EU
EU RoHS Dir. 2011/65/EU



Safety and EMC Reg. 2016
Hazard. Substances Reg. 2012



Registration for Russia, Belarus, Armenia,
Kazakhstan and Kyrgyzstan



China RoHS Law SJ/T 11363-2006



Commercial information

Order codes	DRB480-24-3-A0 DRB480-24-3-A1
HS code	8504408290
Life-cycle status	Launch
Product revision	D01
Single package	
Width	80mm (3 ⁵ / ₃₂ in)
Height	224mm (8 ¹³ / ₁₆ in)
Depth	182mm (7 ¹¹ / ₆₄ in)
Gross weight	1250g (2.31lb)
Bulk package	
Width	343mm (13 ¹ / ₂ in)
Height	210mm (8 ¹⁷ / ₆₄ in)
Depth	465mm (18 ⁵ / ₁₆ in)
Quantity	8 units
Pallet	
Width	1000mm (39 ³ / ₈ in)
Length	1200mm (47 ¹ / ₄ in)
Quantity	192 units
Manufacturer warranty	3 years

Model selector

Model name	Output Power	Output Voltage	Feature
DRB120-12-3-A0	120W	12V _{DC}	Screw terminals
DRB120-12-3-A1	120W	12V _{DC}	Push-in terminals
DRB120-24-3-A0	120W	24V _{DC}	Screw terminals
DRB120-24-3-A1	120W	24V _{DC}	Push-in terminals
DRB240-24-3-A0	240W	24V _{DC}	Screw terminals
DRB240-24-3-A1	240W	24V _{DC}	Push-in terminals
DRB240-48-3-A0	240W	48V _{DC}	Screw terminals
DRB240-48-3-A1	240W	48V _{DC}	Push-in terminals
DRB480-24-3-A0	480W	24V _{DC}	Screw terminals
DRB480-24-3-A1	480W	24V _{DC}	Push-in terminals
DRB480-48-3-A0	480W	48V _{DC}	Screw terminals
DRB480-48-3-A1	480W	48V _{DC}	Push-in terminals
DRB480-72-3-A0	480W	72V _{DC}	Screw terminals
DRB480-72-3-A1	480W	72V _{DC}	Push-in terminals
DRB960-24-3-A0	960W	24V _{DC}	Screw terminals
DRB960-24-3-A1	960W	24V _{DC}	Push-in terminals
DRB960-48-3-A0	960W	48V _{DC}	Screw terminals
DRB960-48-3-A1	960W	48V _{DC}	Push-in terminals
DRB960-72-3-A0	960W	72V _{DC}	Screw terminals
DRB960-72-3-A1	960W	72V _{DC}	Push-in terminals



Accessories



DBM buffer modules

In order to secure process uptime and reliability in 24V low-voltage systems, DBM buffer modules increase hold-up time or provide a reserve for peak loads.

DBM20

20A input/output, electrolytic capacitors, signalling & control, screw terminals

DBM20/E

20A input/output, electrolytic capacitors, signalling & control, spring clamp terminals

emea.lambda.tdk.com/uk/products/dbm20



DRM redundancy modules

For building fault tolerant 12/24V systems, DRM redundancy modules can be used to decouple n+1 power supplies.

DRM40

40A output, 2x20A input, screw terminals, DC OK and balancing LEDs

DRM40B

40A output, 2x20A input, screw terminals

emea.lambda.tdk.com/uk/products/drm40



DDA DC/DC converter

Non-isolated step-down converter for creating additional DC bus voltages from a single DC input source.

DDA250

Single output 20A at 3.3..15V, input 9..53V, DC OK LED, screw terminals

DDA325

Dual output 14A at 3.3..24V and 8A at -3.3..-24V, input 9..40V, DC OK LEDs, screw terminals

DDA500

Dual output 2x20A at 3.3..15V, input 9..53V, DC OK LEDs, screw terminals

emea.lambda.tdk.com/uk/products/dda



Index

1.	General	6
1.1	Proper handling of the product.....	6
1.2	Protection enclosure required.....	6
1.3	Humid environments.....	6
1.4	Switch or circuit-breaker mounting position.....	6
1.5	Observe country-specific regulations.....	6
1.6	Prohibited electrical/mechanical modifications.....	6
1.7	Expiry of the manufacturer's warranty.....	6
1.8	Use of third-party products.....	6
1.9	Standard test conditions.....	6
1.10	Description of user elements.....	6
2.	Electrical output	7
3.	Electrical input	8
4.	Performance	9
5.	Ambient conditions	10
6.	Reliability and Service lifetime	12
7.	Dimensions & Mechanical data	12
8.	Installation clearances	14
9.	Wiring & Connection	14
10.	Signaling & Control	15
11.	Block diagram	16
12.	Device protection	16
13.	Electrical Safety	17
13.1	Overvoltage category design.....	17
13.2	Insulation strength.....	17
13.3	HIPOT test.....	18
14.	Electromagnetic immunity	19
15.	Electromagnetic emission	19
16.	Certifications & Approvals	20
17.	Designed to meet	20
18.	Compliance & Registration	20
19.	Typical use-cases	21
19.1	Parallel Operation.....	21
19.2	Series operation.....	22
19.3	Two-phase operation.....	23



List of abbreviations

avg.	<i>average</i>	The arithmetic average calculated from a row of values.
CC		Constant output current
CGD		Corner grounded delta (AC power system)
chap.		Chapter
Dir.		Directive
eCap		Electrolytic capacitor
EMC		Electromagnetic Compatibility
Iac		AC input current under a particular operating condition
Iout		DC output current under a particular operating condition
Iout_boost		Available current reserve beyond Iout_nom (w/o a drop in Uset) that can be delivered for a limited time.
Iout_nom		Continuous nominal DC output current under STC.
Iout_ol		Max. intermittent DC output current in an overload situation and a shortfall of Uset.
Iout_sc		Max. short circuit DC output current and Uout < 20% Uout_nom
ITU		International Telecommunication Union
max.	<i>maximum</i>	The maximum value which a parameter can assume, or which must not be exceeded.
MCB		Miniature circuit breaker
min.	<i>minimum</i>	The minimum value which a parameter can assume, or must not be fallen below.
MTBF		Mean Time Between Failure
nom.	<i>nominal</i>	The ideal or reference value of a technical parameter which is guaranteed under STC. All nominal values in this document refer to each other and represent the general specification of the device.
OCP		Overcurrent protection
OTP		Overtemperature protection
OVP		Overvoltage protection
PELV		Protective Extra Low Voltage
Pout_boost		Available power reserve beyond Pout_nom that can be delivered for a limited time.
Pout_nom		Nominal output power
PSU		Power supply unit
Reg.		Regulation
SELV		Safety Extra Low Voltage
STC		Standard test conditions (see „1. General“ on page 6)
typ.	<i>typical</i>	The typical value of a parameter is not guaranteed but can be assumed under STC. The min. or max. value must be determined during the engineering process of the end application.
Uout		DC output voltage under a particular operating condition
Uout_nom		Nominal DC output voltage
Uset		Manually set output voltage via voltage potentiometer
UVP		Undervoltage protection
/		Separator between two values. The conditions to which the values refer can be found in the last column of the table.
..		Specifies a range of values.

Table data structure

X. Technical category

Technical parameter	Characteristic (optional)	Values	Condition (optional)
---------------------	---------------------------	--------	----------------------

1. General

1.1 Proper handling of the product

The faultless and safe operation of the products requires proper transport, proper storage, set-up, assembly, installation, commissioning, operation and maintenance. The permissible ambient conditions must be observed. Instructions in the associated documentation must be observed.

1.2 Protection enclosure required

The device must be installed in a protective housing or control cabinet to which only qualified personnel have access.

1.3 Humid environments

Do not operate the device in a damp environment or in an environment where condensation is likely to occur.

1.4 Switch or circuit-breaker mounting position

A switch or circuit-breaker must be mounted near the equipment.

1.5 Observe country-specific regulations

In addition to the product documentation, the relevant country-specific regulations for the installation of the device must be observed.

1.6 Prohibited electrical/mechanical modifications

The product must not be modified in any way electrically or mechanically. Modifications can result in fatal injuries and damage to property.

1.7 Expiry of the manufacturer's warranty

The power supply is maintenance-free. Repairs can only be carried out by the manufacturer. Opening the housing voids the manufacturer's warranty.

1.8 Use of third-party products

If third-party products and components are used for power or voltage increase, buffering (AC or DC side), EMC filtering, redundancies or for DC side load protection, it must be in accordance with the TDK-Lambda product specification.

1.9 Standard test conditions

Unless otherwise stated, all values are specified in normal mounting position, at full load, nominal input and output voltages, 25°C (131°F) ambient temperature and a run-in time of 5 minutes.

1.10 Description of user elements

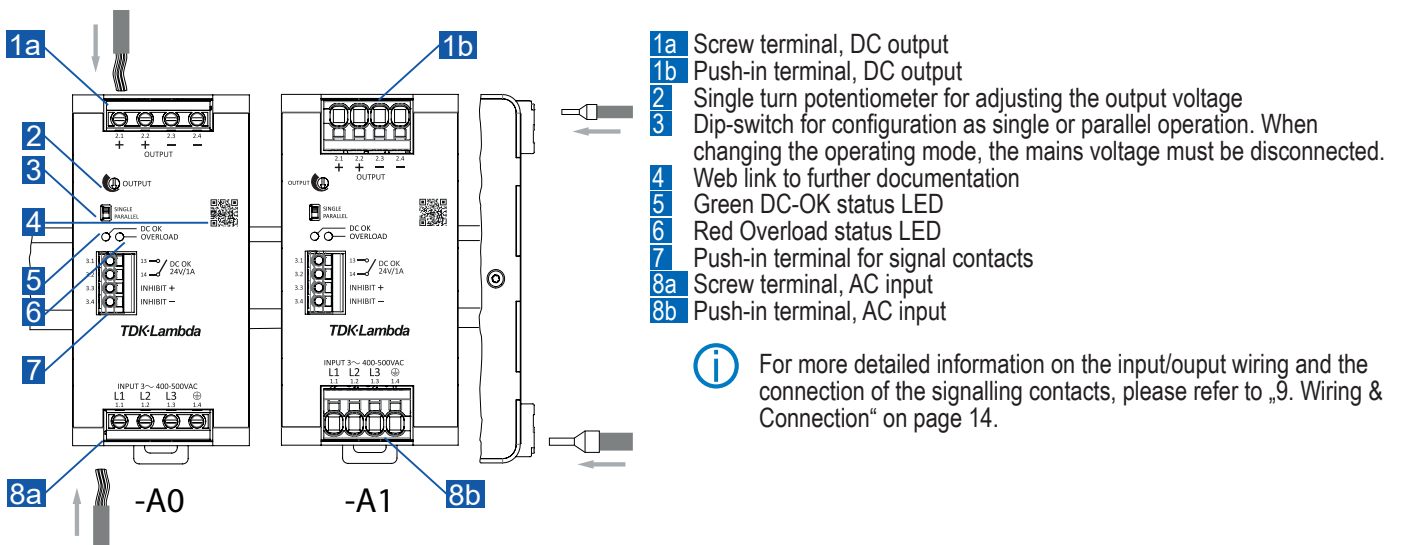

Fig. 1: Description of user elements

2. Electrical output

Output voltage [U _{out_nom}]	nom.	24V _{DC}	
Adjustment range [U _{set}]	nom.	22.5..29V _{DC}	
Adjustment tolerance	max.	±3%	at upper/lower end position of voltage potentiometer
Factory default		24V _{DC} (±0.1%)	
Output current [I _{out_nom}]	nom.	20A	
Boost current 1 [I _{out_boost1}]	max.	30A / 5s	<55°C _{amb} , 100% I _{out_nom} , 280..575V _{AC}
Boost current 2 [I _{out_boost2}]	max.	30A / 7s	<55°C _{amb} , 100% I _{out_nom} , 280..575V _{AC}
Overload behaviour		Constant current + Intermittent mode (Hiccup)	see Fig. 3
SC hiccup current [I _{out_hc}]	max. avg.	30A / 5s 0A / 9.5s	
Short-circuit proof		yes, with auto-recovery	
Instant SC current [I _{out_sc}]	max.	60A	
Start-up delay	typ.	0.6s	
Rise time	typ.	90ms	0% P _{out_nom}
	typ.	90ms	100% P _{out_nom} , resistive load
Voltage overshoot	typ.	0 / 0V _{DC}	400 / 500V _{AC}
Fall time	typ.	30ms	
Hold-up time	min.	24ms	
Output capacitance	max.	26470μF	
Capacitive load start-up	max.	20000μF	22.5..29V _{DC}
Feedback voltage	max.	35V _{DC}	
Return voltage	max.	40mA	OFF mode
Line regulation	max.	0.05%	350..550V _{AC}
Load regulation	max.	0.4%	350..550V _{AC}
	max.	2.9%	350..550V _{AC} , parallel mode
Dynamic response	typ.	±680mV _{pp}	350..550V _{AC} , 10..100% P _{out_nom} , transient frequency 10Hz
Ripple & noise voltage	max.	30mV _{pp}	350..550V _{AC} , +25..+70°C _{amb}
	max.	150mV _{pp}	350..550V _{AC} , -25..+25°C _{amb}

*The measurement was performed with a short twisted pair cable using a 120μF eCap and a 0.1μF cCap connected in parallel. A bandwidth limit of 20MHz is required.

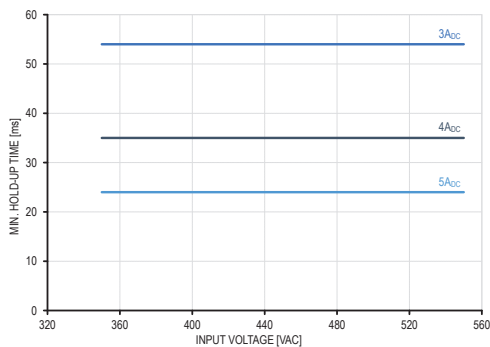

Fig. 2: Hold-up times under different load conditions and in dependence of the input voltage

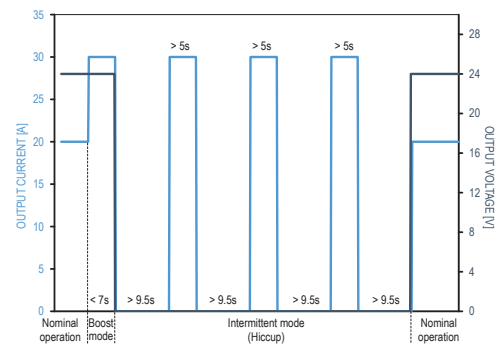

Fig. 3: Output current and voltage in different operation modes

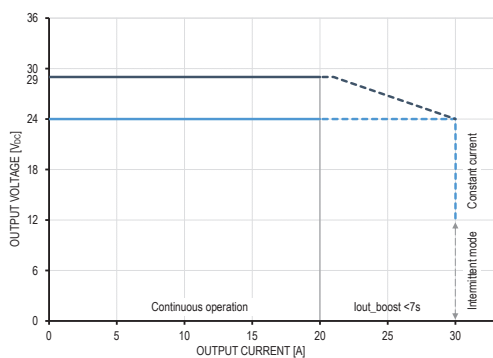

Fig. 4: Output voltage in dependence of output load current

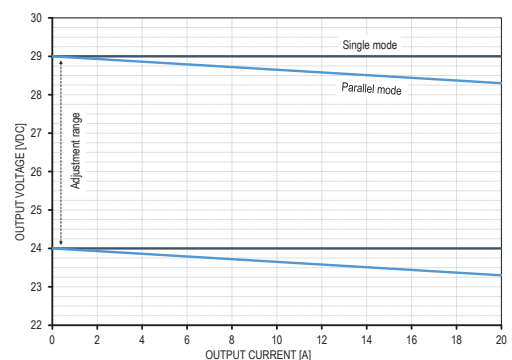

Fig. 5: Voltage drop in parallel mode in dependence of the load current

Unless otherwise stated, all values are specified in normal mounting position, at full load, nominal input and output voltages, 25°C (77°F) ambient temperature and a run-in time of 5 minutes.

3. Electrical input

AC power systems	TN, TT, IT (IEC 61010-1), CGD	
Mains Frequency	<i>nom.</i>	50 / 60Hz
Frequency range	<i>max.</i>	47 .. 63Hz
AC input voltage* [U _{in_nom}]	<i>nom.</i>	3x400 .. 500V _{AC}
Voltage range	<i>max.</i>	3x350 .. 575V _{AC}
Turn-ON voltage	<i>typ.</i>	320V _{AC}
Turn-OFF voltage	<i>typ.</i>	315V _{AC}
AC input current	<i>max.</i>	3x1.2A
AC input current RMS	<i>typ.</i>	3x0.80 / 3x0.65A
Crest factor	<i>typ.</i>	2.0 / 2.2
Inrush current	<i>typ.</i>	17 / 22A <200μs
Inrush energy	<i>typ.</i>	0.04 / 0.05A ² s
Input capacitance	<i>max.</i>	60μF

*The product is also capable to operate with DC input voltage. Please contact your local support team (see page 24).

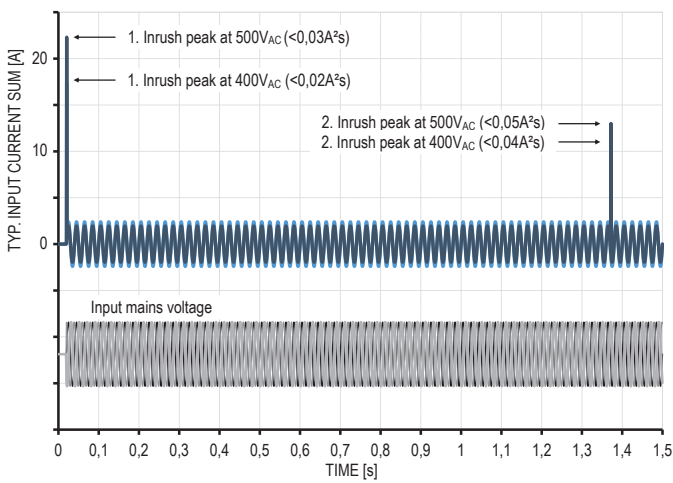

Fig. 6: Inrush current and energy during start-up phase

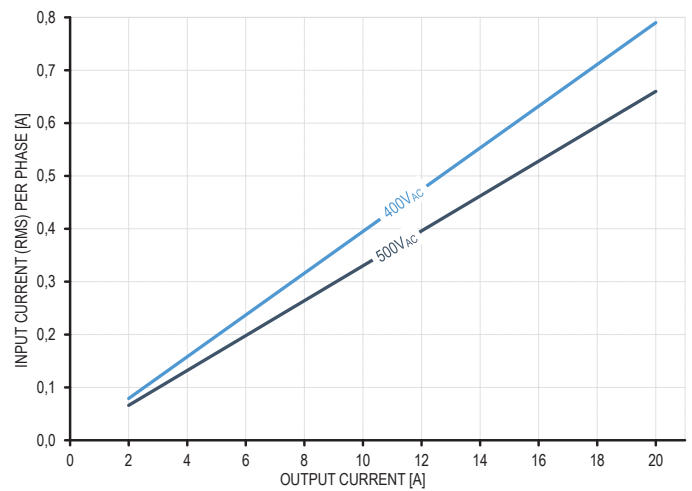

Fig. 7: Typical input current per phase in dependence of the load current

4. Performance

Output power [P _{out_nom}]	<i>nom.</i> 480W	
Boost power 1 [P _{out_boost1}]	<i>max.</i> 720W / 5s	<55°C _{amb} , 100% P _{out_nom} , 280 .. 575V _{AC}
Boost power 2 [P _{out_boost2}]	<i>max.</i> 720W / 7s	<55°C _{amb} , 100% P _{out_nom} , 280 .. 575V _{AC}
Duty cycle 1	<i>max.</i> 0.30	See boost power 1
Duty cycle 2	<i>max.</i> 0.15	See boost power 2
Dropped phase power	<i>max.</i> 240W	2x400 .. 500V _{AC} , not compliant with IEC/EN 61000-3-2 harmonic currents
Apparent input power	<i>typ.</i> 549 / 550VA	400 / 500V _{AC}
Active input power	<i>typ.</i> 505 / 506W	400 / 500V _{AC}
Reactive input power	<i>typ.</i> 215Var	
Power factor	<i>typ.</i> 0.92	
Conversion efficiency	<i>typ.</i> 95.1 / 94.9% <i>avg.*</i> 94.1 / 93.7%	400 / 500V _{AC} , 100% P _{out_nom} 400 / 500V _{AC} , 25 .. 100% P _{out_nom}
Power losses	<i>typ.</i> 24.7 / 25.8W <i>avg.*</i> 30.1 / 32.3W	400 / 500V _{AC} , 100% P _{out_nom} 400 / 500V _{AC} , 25 .. 100% P _{out_nom}
No-load consumption	<i>max.</i> 3.0 / 3.2W	400 / 500V _{AC} , 0% P _{out_nom}
Stand-by consumption	<i>max.</i> 1.6 / 1.9W	Inhibit status HIGH (see Fig. 23)

*Average efficiency under 25%, 50%, 75% and 100% load conditions, according to eco-design requirements of EU commission regulation 2019/1782.

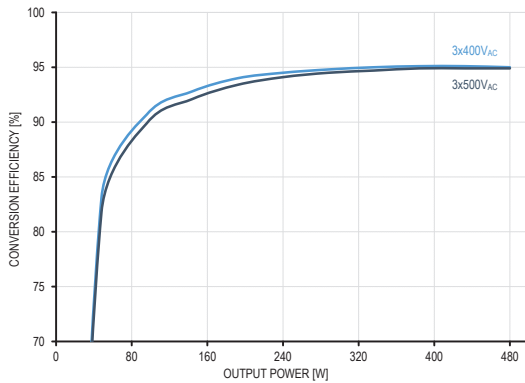

Fig. 8: Conversion efficiency in dependence of the output power

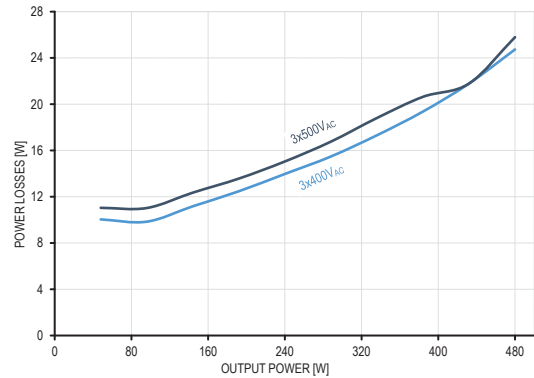

Fig. 9: Power losses in dependence of the output power

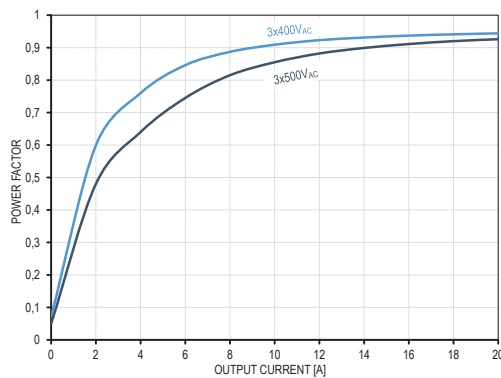

Fig. 10: Input power factor in dependence of the output current

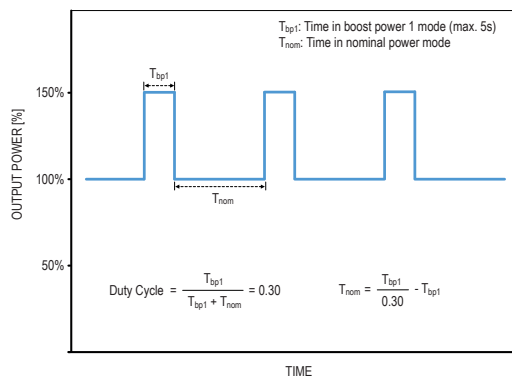

Fig. 11: Period and frequency of use of boost power 1 in normal mounting position

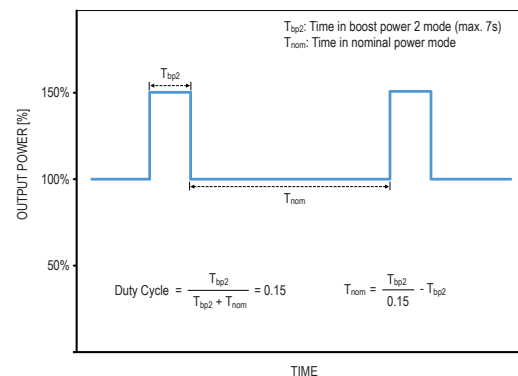

Fig. 12: Period and frequency of use of boost power 2 in normal mounting position

Unless otherwise stated, all values are specified in normal mounting position, at full load, nominal input and output voltages, 25°C (77°F) ambient temperature and a run-in time of 5 minutes.

5. Ambient conditions

Ambient storage temperature	<i>max.</i>	-40 .. +85°C _{amb} (-40 .. +185°F _{amb})	
Ambient operating temperature	<i>max.</i>	-25 .. +70°C _{amb} (-13 .. +158°F _{amb})	normal mounting position, >55°C _{amb} (>131°F _{amb}) rotated ±90° around X or Y axis rotated 180°
	<i>nom.</i>	-25 .. +55°C _{amb} (-13 .. +131°F _{amb})	
	<i>nom.</i>	-25 .. +40°C _{amb} (-13 .. +104°F _{amb})	
	<i>nom.</i>	-25 .. +40°C _{amb} (-13 .. +104°F _{amb})	
Power derating*	<i>min.</i>	12W/°C _{amb} (6.67W/°F _{amb})	normal mounting position, >55°C _{amb} (>131°F _{amb})
	<i>min.</i>	14.4W/°C _{amb} (8.00W/°F _{amb})	rotated ±90° around X or Y axis, >40°C _{amb} (>104°F _{amb})
	<i>min.</i>	14.4W/°C _{amb} (8.00W/°F _{amb})	rotated 180°, >40°C _{amb} (>104°F _{amb})
Cooling concept		Natural convection	
Relative storage humidity IEC 60068-2-30	<i>max.</i>	95%	non-condensing
Relative operation humidity IEC 60068-2-30	<i>max.</i>	95%	non-condensing
Operating altitude	<i>nom.</i>	3000mASL (9842ftASL)	not UL approved, reduced OVC
	<i>max.</i>	6000mASL (19685ftASL)	
Percental power derating	<i>min.</i>	5% per 1000m (5% per 3281ft)	>3000mASL (>9842ftASL)
Temperature derating	<i>min.</i>	5°C per 1000m (9°F per 3281ft)	>3000mASL (>9842ftASL)
Atmospheric pressure	<i>nom.</i>	689hPa	
	<i>max.</i>	469 .. 1070hPa	
Pollution degree IEC 60664-1, IEC 62477-1		2	
Vibration sinusoidal IEC 60068-2-6		2g / 10 .. 500Hz, 1 hour/direction X,Y,Z	mounted on DIN rail
Shock test sinusoidal halfwave IEC 60068-2-27		30g / 11ms ±5ms, 3 bumps/direction, 9 bumps total	mounted on DIN rail
Audible noise		Some audible noise may be heard during no load, overload or short circuit.	

*Not actively controlled

i For altitudes above 3000mASL (9842ftASL) the next lower OVC must be considered.

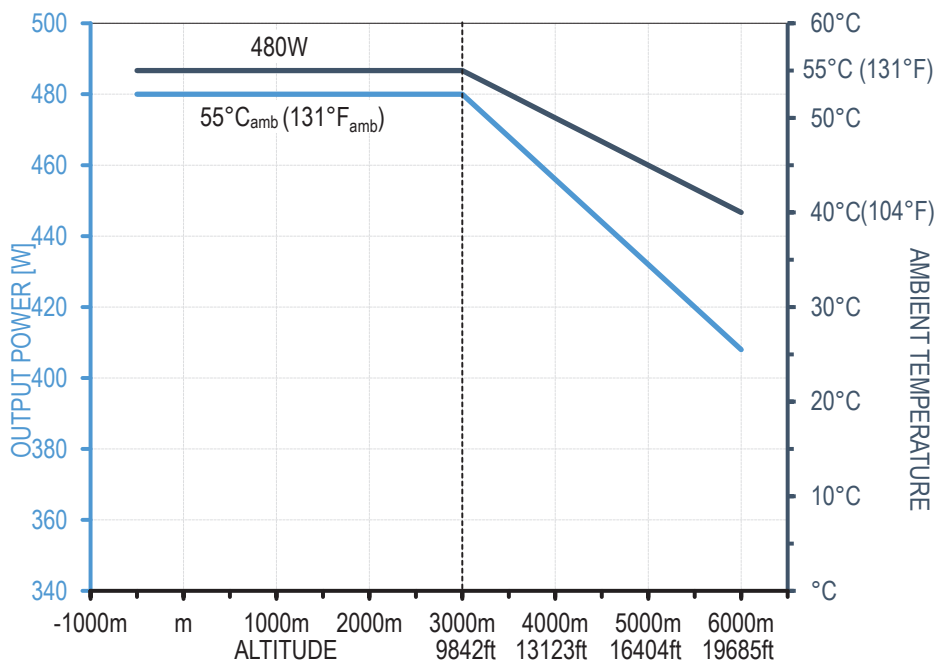

Fig. 13: Output power or ambient temperature derating at increasing altitudes

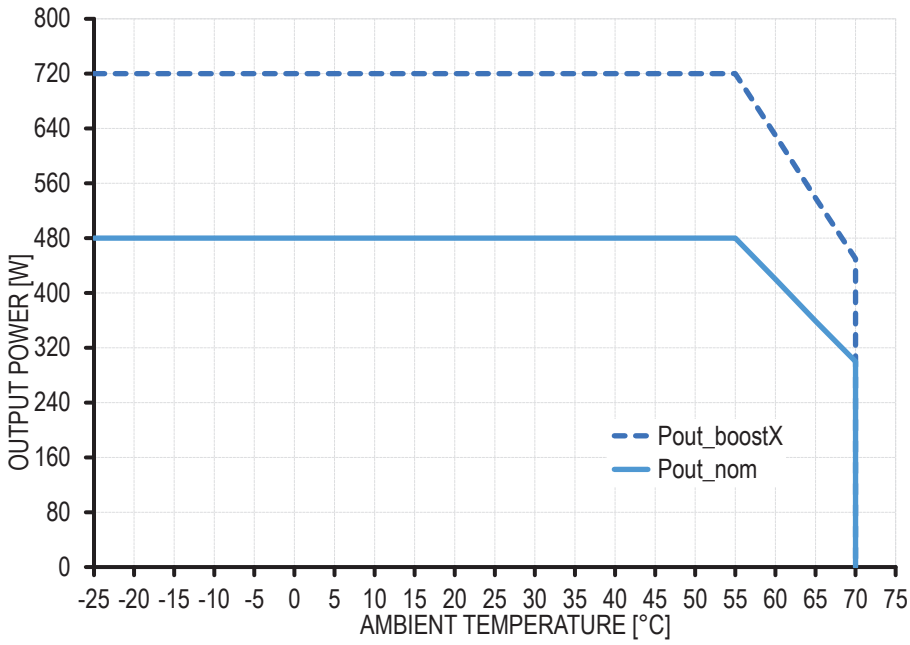

Fig. 14: Available output power in dependence of the ambient temperature for normal mounting position

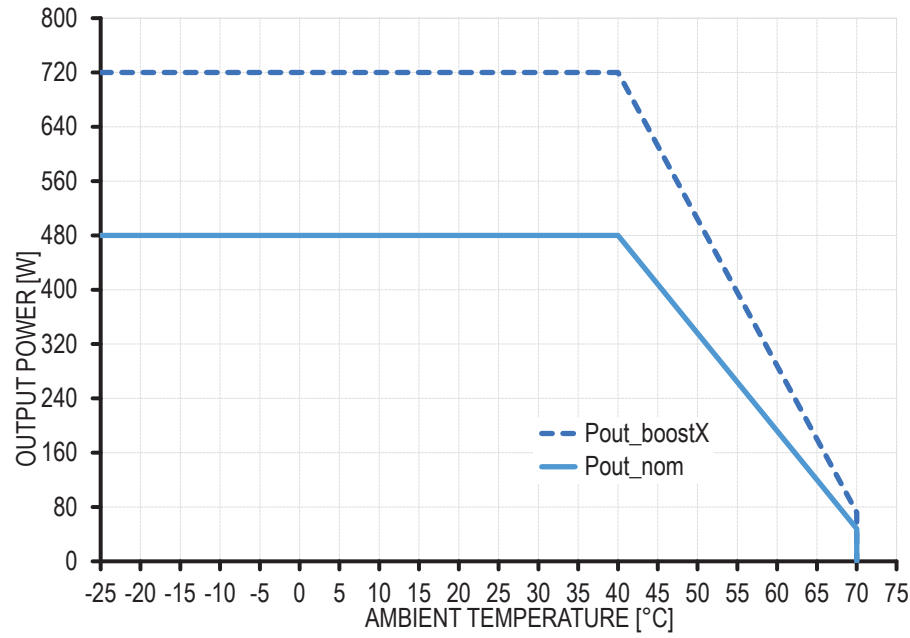
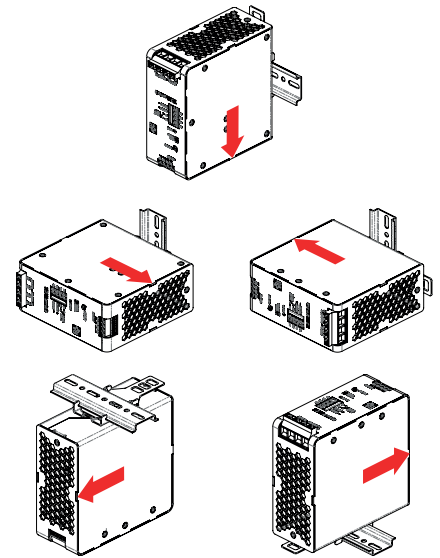
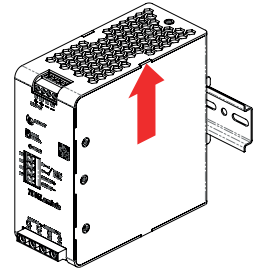
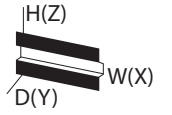



Fig. 15: Available output power in dependence of the ambient temperature for rotated mounting positions



6. Reliability and Service lifetime

Service lifetime	<i>min.</i> 70 000 / 68 000hrs	400 / 500V _{AC} , 100% P _{out_nom} , 40°C _{Camb} , 24/7
	<i>min.</i> 148 000 / 124 000hrs	400 / 500V _{AC} , 75% P _{out_nom} , 40°C _{Camb} , 24/7
	<i>min.</i> 197 000 / 190 000hrs	400 / 500V _{AC} , 100% P _{out_nom} , 25°C _{Camb} , 24/7
Early life MTBF	<i>min.</i> 0.88M / 0.82M / 0.70M hrs	25 / 40 / 55°C _{Camb} , 50% P _{out_nom}
Telcordia SR-332 Issue 4	<i>min.</i> 0.48M / 0.41M / 0.31M hrs	25 / 40 / 55°C _{Camb} , 100% P _{out_nom}
Service life MTBF	<i>min.</i> 4.4M / 3.2M / 1.9M hrs	25 / 40 / 55°C _{Camb} , 50% P _{out_nom}
Telcordia SR-332 Issue 4	<i>min.</i> 0.86M / 0.66M / 0.44M hrs	25 / 40 / 55°C _{Camb} , 100% P _{out_nom}

 The maximum service lifetime guaranteed by the eCap manufacturer is 131 400hrs (15 years). All values above are theoretically calculated.

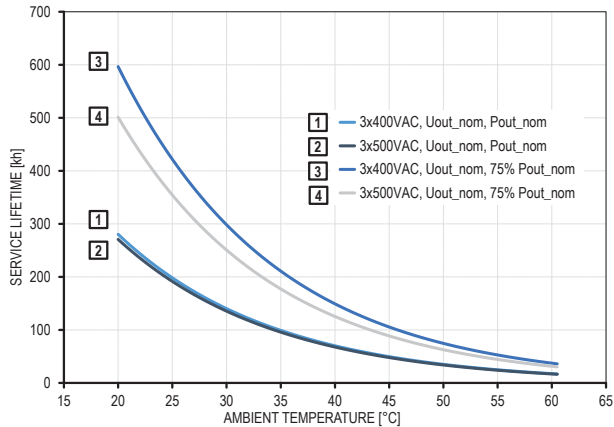

Fig. 16: Power supply service lifetime in dependence of ambient temperature

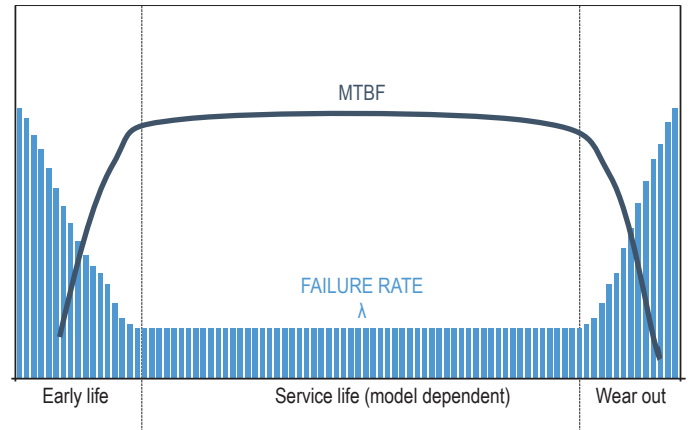

Fig. 17: Generic diagram visualising failure rate and MTBF values during the products life-cycle

7. Dimensions & Mechanical data

Enclosure material	Aluminum	
Cover material	Aluminum	
Inflammability class	V0	incl. connection terminals
UL 94		
Width	65.0mm (2 ⁹ / ₁₆ in)	
Height	129.0mm (5 ⁵ / ₆₄ in)	
Depth		w/o DIN rail
Screw terminal model (-A0)	156.8mm (6 ¹¹ / ₆₄ in)	
Push-in terminal model (-A1)	159.3mm (6 ¹⁷ / ₆₄ in)	
Weight	1050g (2.32lb)	
Lever arm	<i>max.</i> 70mm (2 ³ / ₄ in)	into the direction of Y axis
Torsional moment on DIN rail	<i>max.</i> 0.72Nm (6.38lb in)	into the direction of Z axis
Enclosure openings	<i>max.</i> 7mm (9/ ₃₂ in)	
DIN rail types	TH 35-7.5, TH 35-15	
IEC 60715		

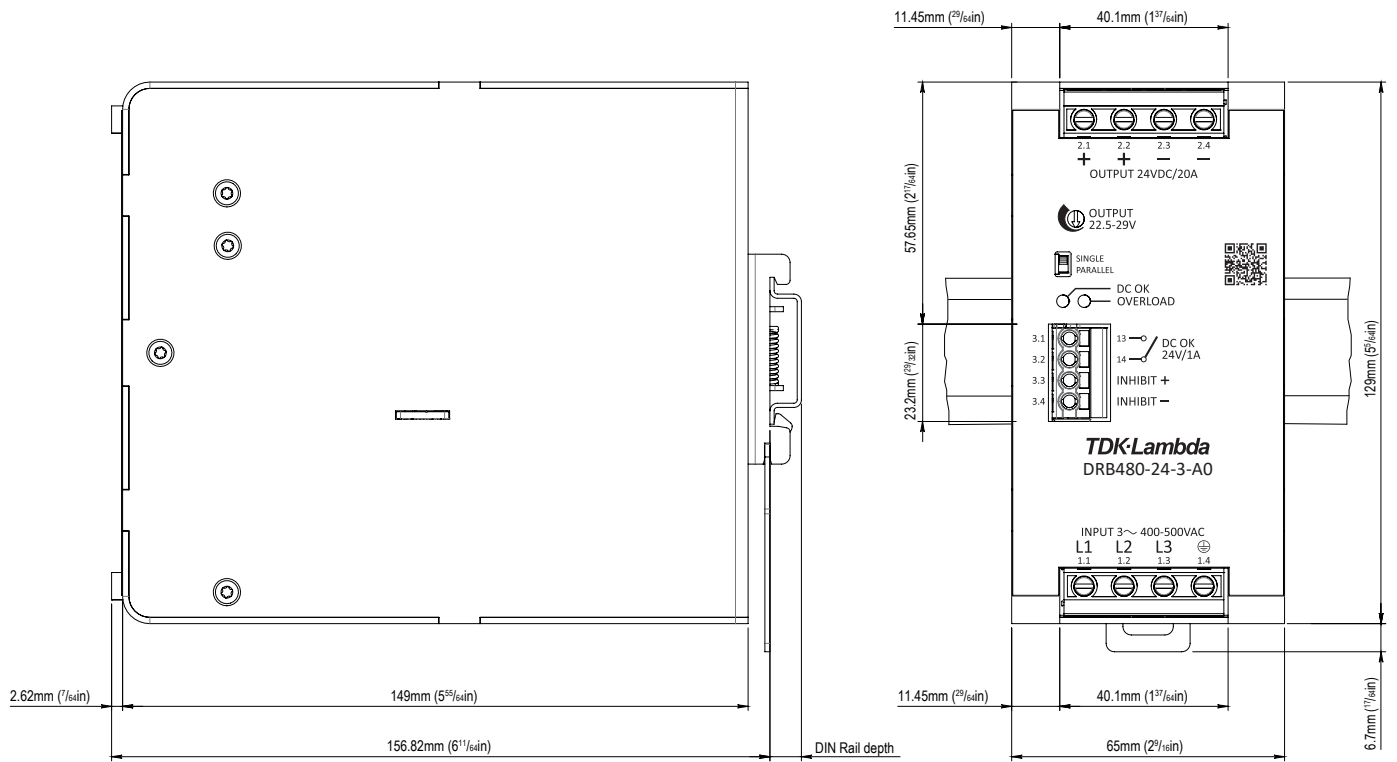

Fig. 18: Dimension drawing of DRB480-24-3-A0

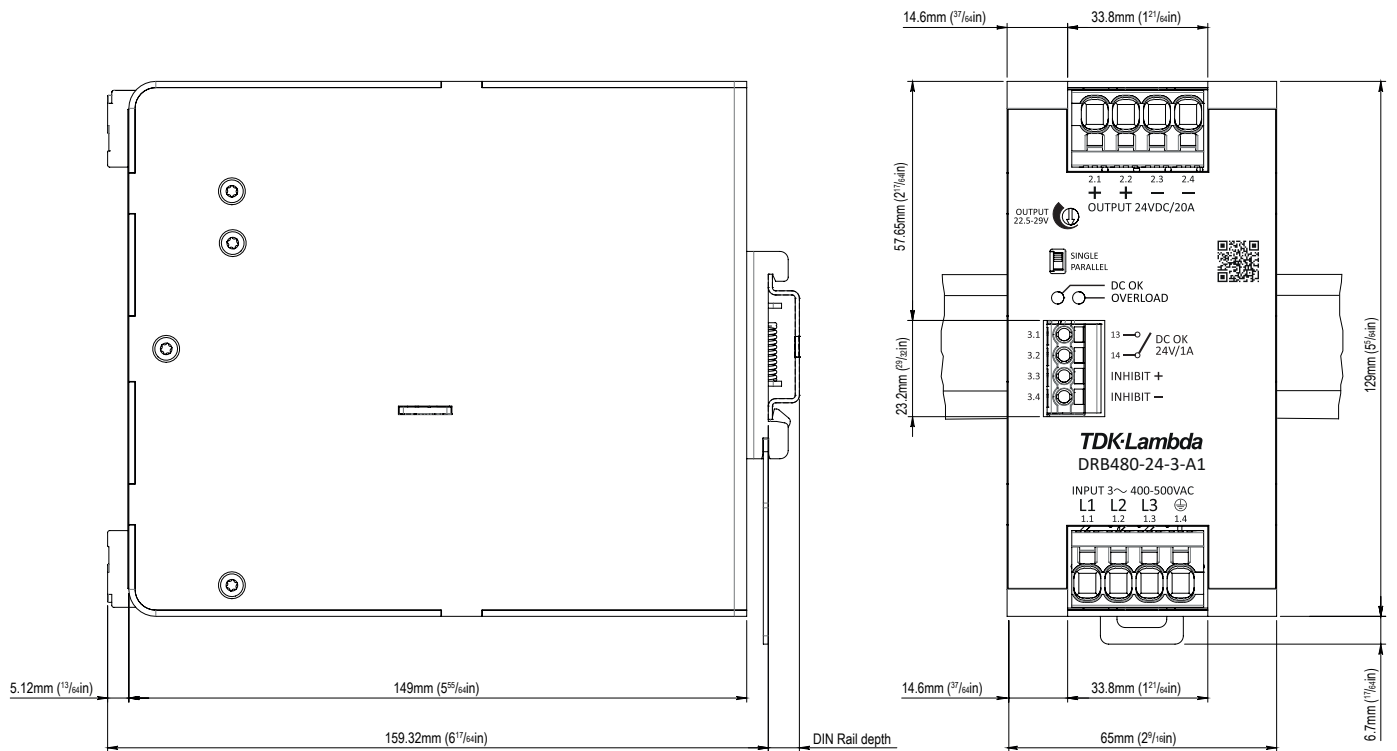

Fig. 19: Dimension drawing of DRB480-24-3-A1

Unless otherwise stated, all values are specified in normal mounting position, at full load, nominal input and output voltages, 25°C (77°F) ambient temperature and a run-in time of 5 minutes.

8. Installation clearances

Vertically (Z axis)

Top side	1	min.	40mm (1 ³⁷ / ₆₄ in)
Bottom side	2	min.	20mm (2 ⁵ / ₃₂ in)

installation above heat sources not permitted

Horizontally (X axis)

Left side / Right side	3a 4a	min.	5mm (1 ³ / ₆₄ in)
Left side / Right side	3b 4b	min.	2mm (5 ⁵ / ₆₄ in)

to heat sources (same power rating) to passive components

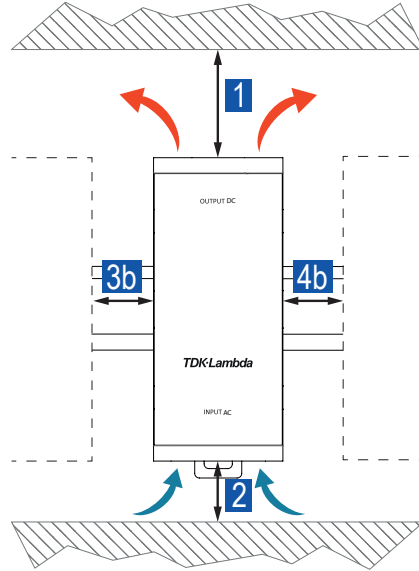
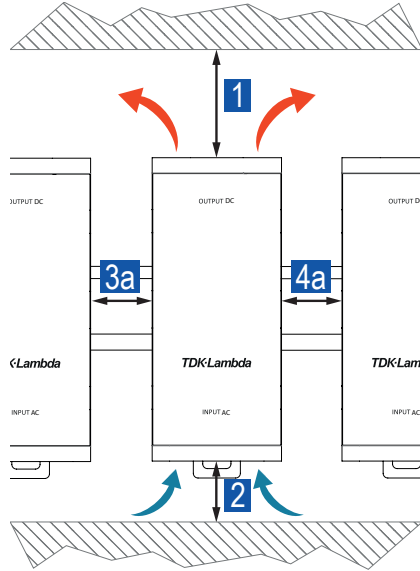

Fig. 20: Installation clearances to heat sources

Fig. 21: Installation clearances to passive components

9. Wiring & Connection

DRB480-24-3-A0

Terminal type
Recommended screw driver

Solid wire
Flexible wire
Standard ferrules
Uninsulated ferrules
Stripping length
Tightening torque

Input

Slotted screw
SL 0.8x4.0mm
(SL 1¹/₃₂ x 9⁹/₃₂in)
0.5-4.0mm² (26-10AWG)
0.5-4.0mm² (26-10AWG)
0.25-2.5mm²
0.25-2.5mm²
6-7mm (1⁵/₆₄ - 9⁹/₃₂in)
0.5-0.8Nm (4.4-7.0lb in)

Output

Slotted screw
SL 0.8x4.0mm
(SL 1¹/₃₂ x 9⁹/₃₂in)
0.5-4.0mm² (26-10AWG)
0.5-4.0mm² (26-10AWG)
0.25-2.5mm²
0.25-2.5mm²
6-7mm (1⁵/₆₄ - 9⁹/₃₂in)
0.5-0.8Nm (4.4-7.0lb in)

Signaling

Push-in
SL 0.5x3.0mm
(SL 1¹/₆₄ x 1¹/₈in)
0.2-2.5mm² (26-12AWG)
0.2-2.5mm² (26-12AWG)
0.2-1.5mm²
0.2-2.5mm²
9-10mm (2³/₆₄ - 2⁵/₆₄in)
-

DRB480-24-3-A1

Terminal type
Recommended screw driver

Solid wire
Flexible wire
Standard ferrules
Uninsulated ferrules
Stripping length

Push-in
SL 0.6x3.5mm
(SL 1¹/₃₂ x 9⁹/₆₄in)
0.2-10.0mm² (24-8AWG)
0.2-6.0mm² (24-8AWG)
0.25-4.0mm²
0.25-6.0mm²
15mm (1⁹/₃₂in)

Push-in
SL 0.6x3.5mm
(SL 1¹/₃₂ x 9⁹/₆₄in)
0.2-10.0mm² (24-8AWG)
0.2-6.0mm² (24-8AWG)
0.25-4.0mm²
0.25-6.0mm²
15mm (1⁹/₃₂in)

Push-in
SL 0.5x3.0mm
(SL 1¹/₆₄ x 1¹/₈in)
0.2-2.5mm² (26-12AWG)
0.2-2.5mm² (26-12AWG)
0.2-1.5mm²
0.2-2.5mm²
9-10mm (2³/₆₄ - 2⁵/₆₄in)

i In compliance to IEC/EN/UL 62368-1 (Ed.2) ferrules are required if flexible wires are used. In compliance with IEC/EN/UL 61010-1, 61010-2-201 appropriate copper wires must be used that withstand operating temperatures of at least 75°C (167°F) in ambients NOT exceeding 40°C (104°F), and 90°C (194°F) in ambients exceeding 40°C (104°F).

10. Signaling & Control

DC OK

Type		Relay contact	
Characteristic		N/O	
Closing		$U_{out} > 95\% U_{set}$	duration min. 100ms
Opening		$U_{out} < 85\% U_{set}$	duration min. 100ms
Resistive load	<i>nom.</i>	1A	24V _{Dc}
	<i>max.</i>	0.5A	60V _{Dc}
Trigger hysteresis	<i>typ.</i>	0.6V	

Remote ON/OFF

Type		Electrical contact	
Characteristic		Inhibit	
ON threshold	<i>typ.</i>	3V	
OFF threshold	<i>typ.</i>	4.5V	
Restart delay	<i>max.</i>	6s	
Input voltage	<i>max.</i>	30V	
Input current	<i>max.</i>	10mA	
Reference potential		Isolated	
Parallel connection		yes	
Active discharging		no	

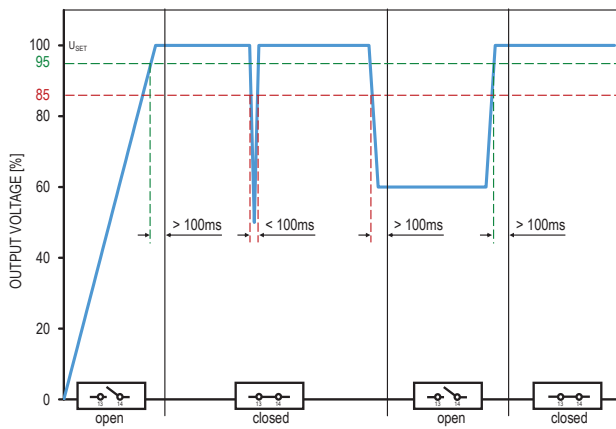

Fig. 22: DC-OK relay characteristic in dependence of output voltage changes

OFF mode

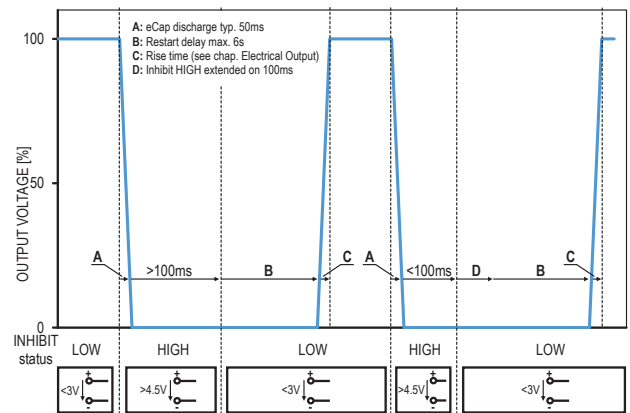

Fig. 23: Control of the output voltage in dependence of the inhibit relay status.

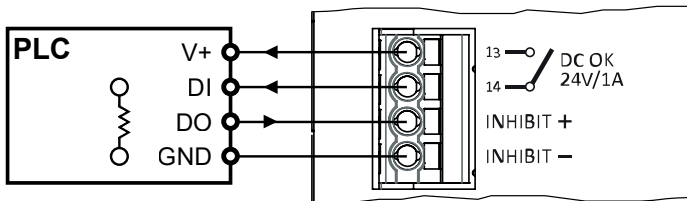
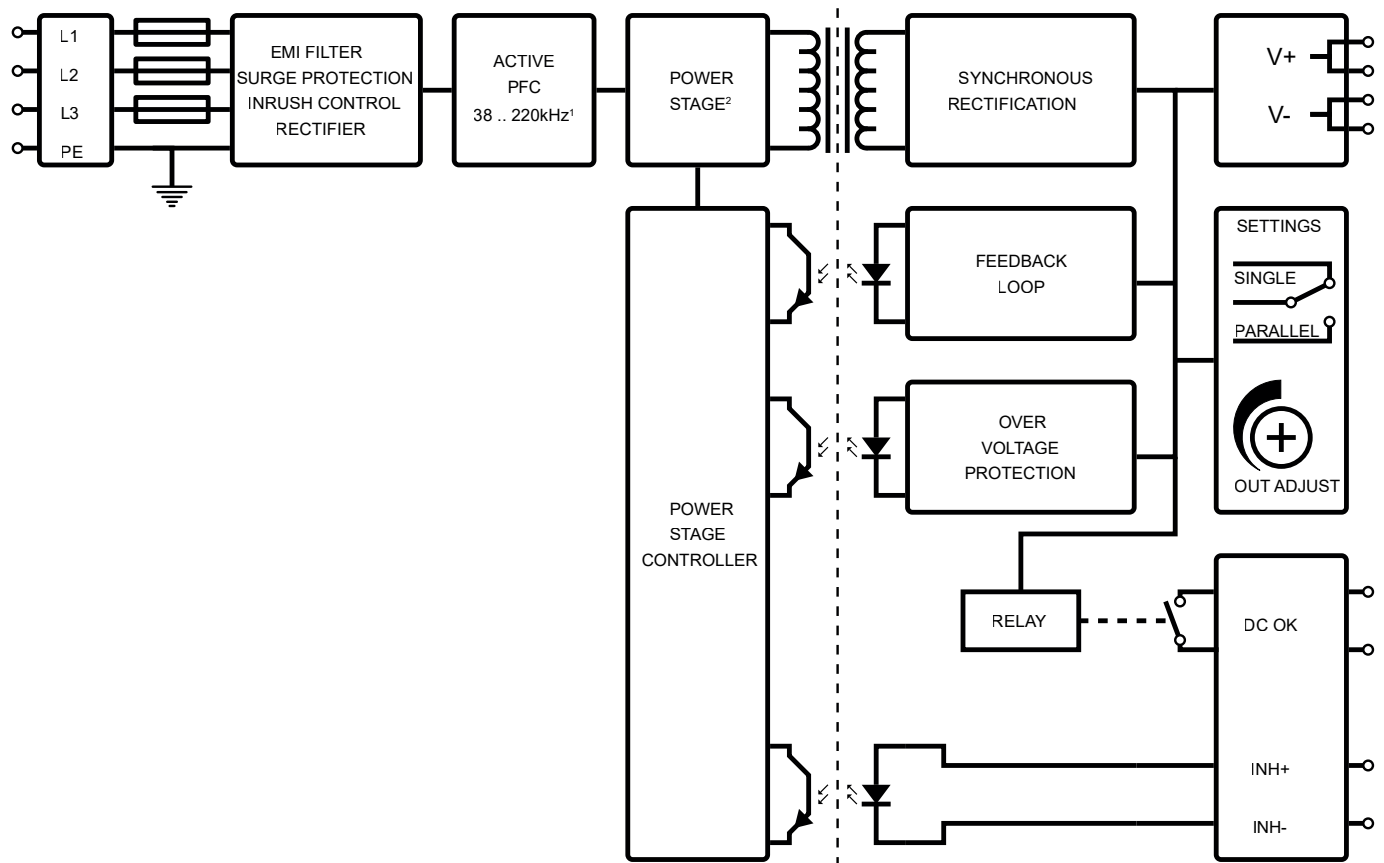

Fig. 24: Generic connection diagram of DC OK and INHIBIT contacts

11. Block diagram



¹Dependent on U_{in} and I_{out}

²Dependent on U_{out} and I_{out}

12. Device protection

Ingress protection degree IEC 60529	IP 20	
NEMA classification NEMA 250-2018	NEMA 1	
Output overtemperature protection (OTP)	Yes, with auto-recovery	
Output overvoltage protection (OVP)	<i>max.</i>	32.9V _{DC} , with auto-recovery
Undervoltage protection threshold (UVP)	<i>max.</i>	310V _{AC}
Output overcurrent protection (OCP)	<i>min.</i>	145%, with auto-recovery
Integrated input fuse	3x T3.15A at L pins	not DC capable, not user replaceable
Suitable MCB types IEC 60898-1, UL 1077	B or C characteristic, 6/8/10A	
Transient protection		
1st level	MOV (Metal Oxide Varistor)	
2nd level	GDT (Gas Discharge Tube)	

i When installed in an end-product, the maximum branch circuit rating must not exceed 20A (IEC/UL 62368-1 Ed.2). If the upstream supply provides a higher ampacity than 20A, an external protection device is required.

13. Electrical Safety

Class of protection IEC 61140	I	PE connection required
Electrical energy source classification IEC 62368-1	ES1	
Safety Extra Low Voltage IEC 61010-2-201, IEC 60950-1	SELV	
Protective Extra Low Voltage IEC 60204-1	PELV	Output must be earthed in the end application
Protective ground resistance	<i>max.</i> 100mΩ	
Ground leakage current IEC 60990	<i>max.</i> 0.9mA <i>max.</i> 1.0mA	TN/TT mains, 3x575V _{AC} , 50Hz TN/TT mains, 3x575V _{AC} , 60Hz
Touch current IEC 60990	<i>max.</i> 40μA <i>max.</i> 50μA	TN/TT mains, 3x575V _{AC} , 50Hz TN/TT mains, 3x575V _{AC} , 60Hz
Overtoltage category IEC 61010-1, IEC 62368-1 (Ed.2)	II	< 3000mASL (< 9842ftASL)

13.1 Overtoltage category design

Underlying IEC standard	61010-1	62368-1 ¹⁾	60950-1	61558-2-16 ²⁾	62477-1	61204-7	60664-1
Mains transient voltage	II	II	II	III	III	III	III
Creepage & Clearance	III	II	III	II	III	III	III

¹⁾Edition 2

²⁾ not applicable along with IEC 61204-7

13.2 Insulation strength

		Type test (60s) IEC 61010-1	Routine test (3s) IEC 61010-1	Field test (3s)
Input / Output	A	3510V _{AC}	3510V _{AC}	3510V _{AC}
Input / PE	B	2210V _{AC}	2210V _{AC}	2210V _{AC}
Input / DC OK	C	3510V _{AC}		3510V _{AC}
Input / INHIBIT	D	3510V _{AC}		3510V _{AC}
Output / PE	E	1390V _{AC}	1390V _{AC}	1390V _{AC}
Output / DC OK	F	1390V _{AC}		1390V _{AC}
Output / INHIBIT	G	1390V _{AC}		1390V _{AC}
DC OK / INHIBIT	H	1390V _{AC}		1390V _{AC}

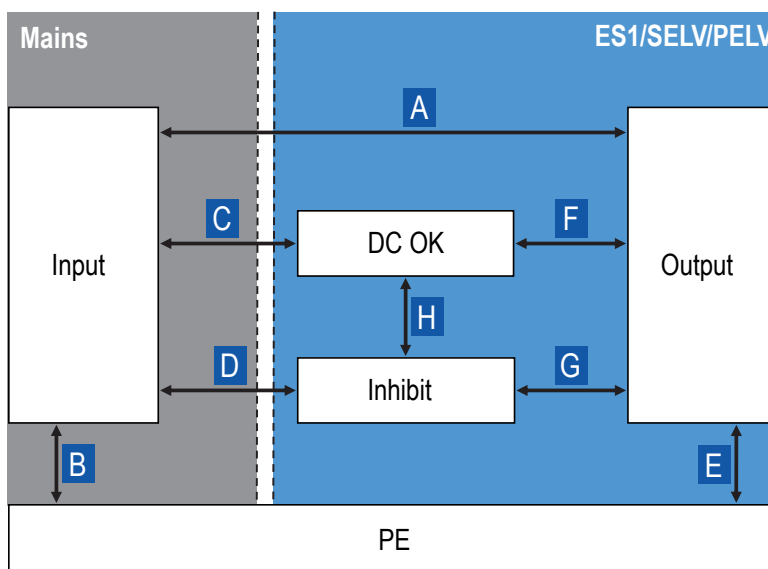

Fig. 25: Schematic of the insulation paths

13.3 HIPOT test

Apart from routine and type test, the end user might need to check the insulation strength during the final inspection and testing to guarantee the electrical safety of the end application. Therefore, a high-voltage test (HIPOT test) can be performed in the field. The following conditions must be observed:

- ▶ As every HIPOT test causes stress on the power supplies safety insulation, avoid frequent HIPOT testing or excessive test voltages
- ▶ The test voltages and durations, as indicated under „13.2 Insulation strength“ on page 17, must not be exceeded
- ▶ The test voltages rise and fall time should be between 2 and 4 seconds
- ▶ For the HIPOT test of the insulation path (B) between Input and PE, the gas discharge tube (GDT) must be disconnected

Disconnection of the GDT:

- 1) Completely remove the connection screw (marked with an arrow) with a Torx X10. (see Fig. 26)
- 2) Keep the screw in a safe place.
- 3) After completion of testing, reconnect the GDT only with the original screw to avoid risk of electrical shock or damage.
- 4) Fasten the screw with a Torx X10 not exceeding a tightening torque of 0.7 Nm.

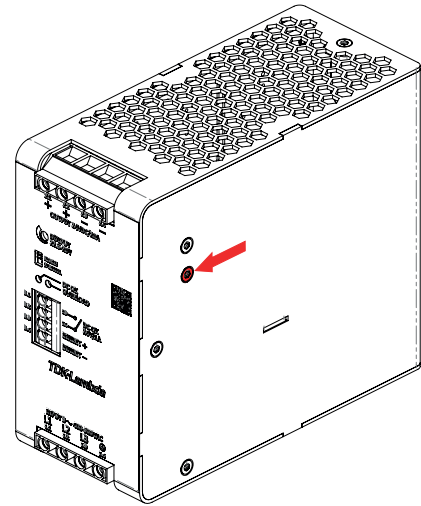

Fig. 26: Position of the connection screw for the GDT

i According to EN 60204-1 (Safety of machinery - Electrical equipment of machines), an individual HIPOT test of the power supply isn't required. During the HIPOT test of the end application, the power supply can be disconnected and only installed once the test has been completed.

14. Electromagnetic immunity

Investigated under generic standards IEC/EN 61000-6-2 (2019) - Immunity for industrial environments.

Electrostatic contact discharge IEC/EN 61000-4-2	4kV	Criterion A	330Ω / 150pF
Electrostatic air discharge IEC/EN 61000-4-2	8kV	Criterion A	330Ω / 150pF
Electromagnetic RF field¹⁾ IEC/EN 61000-4-3	10V/m 3V/m 1V/m	Criterion A Criterion A Criterion A	80MHz..1GHz 1.4GHz..2GHz 2GHz..2.7GHz
Fast transients (burst) IEC/EN 61000-4-4			
Input ²⁾	4kV	Criterion A	5kHz
Output	2kV	Criterion A	5kHz
Signal contact ²⁾	2kV	Criterion A	5kHz
Surge voltages IEC/EN 61000-4-5			
Input symmetrical (L-L) ²⁾	2kV	Criterion A	2Ω+18μF, for φ = 0°,90°,180°,270°
Input asymmetrical (L-PE) ²⁾	4kV	Criterion A	12Ω+9μF, for φ = 0°,90°,180°,270°
Output symmetrical (L-L)	0.5kV	Criterion A	2Ω+18μF
Output asymmetrical (L-PE)	1kV	Criterion A	12Ω+9μF
Signal line asymmetrical (Signal-PE)	1kV	Criterion A	42Ω+0.5μF
Conducted disturbances Input, signal line, PE³⁾ IEC/EN 61000-4-6	10V	Criterion A	150kHz..80MHz
Power frequency magnetic field IEC/EN 61000-4-8	30A/m	Criterion A	50Hz, 60s each axis (x, y, z)
Voltage dips/sags and interruptions IEC/EN 61000-4-11, 61000-4-34, SEMI F47-0706	500ms 200ms 20ms 5000ms	Criterion A Criterion B Criterion A Criterion C	400VAC at 70%, 50Hz 400VAC at 40%, 50Hz 400VAC at 0%, 50Hz 400VAC at 0%, 50Hz

¹⁾ Except for the ITU broadcast frequency bands 87..107MHz, 174..230MHz and 470..790MHz, where the level shall be 3V/m.

²⁾ Exceeds the requirements of the European Low Voltage Directive 2014/35/EU

³⁾ Except for the ITU broadcast frequency bands 47..68MHz, where the level shall be 3V.

Performance level definitions:

Criterion A:

The device continues operation as intended during and after the test. The specified performance level accepts a change of ±10% on nominal output voltage and current. There is neither a violation of the performance level, nor a loss of function if the device is used as intended.

Criterion B:

The device continues operation as intended after the test. The specified performance level accepts a change of ±10% on nominal output voltage and current. There is neither a violation of the performance level, nor a loss of function if the device is used as intended. During the test a violation of the performance level is allowed.

Criterion C:

A temporary loss of function is allowed, provided the function is auto-recoverable, or can be restored by the operation of the controls.



15. Electromagnetic emission

Investigated under generic standards IEC/EN 61000-6-3 (2007) + A1 (2011) / AC (2012) - Emission standard for residential, commercial and light-industrial environments.

Conducted noise emission input EN 55011, CISPR 11	Class B	150kHz..30MHz
Radiated noise emission input EN 55011, CISPR 11	Class B	30MHz..1GHz
Harmonic currents input IEC/EN 61000-3-2	Class A	0kHz..2kHz
Total harmonic distortion (THD) input IEC/EN 61000-3-2	37% per phase	Order 1..40
Voltage changes, voltage fluctuations and flicker Input IEC/EN 61000-3-3	PASS	50Hz

Unless otherwise stated, all values are specified in normal mounting position, at full load, nominal input and output voltages, 25°C (77°F) ambient temperature and a run-in time of 5 minutes.

16. Certifications & Approvals







	UL 61010-1 CAN/CSA-C22.2 No. 61010-1	Safety requirements for electrical equipment for measurement, control, and laboratory use - Part 1: General requirements
	UL 61010-2-201 CAN/CSA-C22.2 No. 61010-2-201	Safety requirements for electrical equipment for measurement, control, and laboratory use - Part 2-201: Particular requirements for control equipment UL file: E356563
	IEC EN 61010-1	Safety requirements for electrical equipment for measurement, control, and laboratory use - Part 1: General requirements
	IEC EN 61010-2-201	Safety requirements for electrical equipment for measurement, control, and laboratory use - Part 2-201: Particular requirements for control equipment
	IEC EN 62368-1 (Ed.2)	Audio/video, information and communication technology equipment - Part 1: Safety requirements
	UL 62368-1 (Ed. 2)	Audio/video, information and communication technology equipment - Part 1: Safety requirements UL file: E511889

17. Designed to meet

The safety design of the product complies additionally with the following harmonised standards.

IEC 60950-1	Information technology equipment - Safety - Part 1: General requirements
IEC/EN 62477-1	Safety requirements for power electronic converter systems and equipment - Part 1: General
IEC/EN 61204-7	Low-voltage switch mode power supplies - Part 7: Safety requirements
IEC/EN 61558-2-16	Safety of transformers, reactors, power supply units and similar products for supply voltages up to 1100 V - Part 2-16: Particular requirements and tests for switch mode power supply units and transformers for switch mode power supply units
EN 60204-1	Safety of machinery - Electrical equipment of machines - Part 1: General requirements

18. Compliance & Registration

	Conformity with health, safety, and environmental protection standards for products sold within the European Economic Area (EEA).
	UKCA (UK Conformity Assessed) is the product marking that is used for certain goods being placed on the United Kingdom market.
	Registration mark to indicate products conformity to the technical regulations of the Eurasian Customs Union (Russia, Belarus, Armenia, Kazakhstan and Kyrgyzstan).
	The Waste Electrical and Electronic Equipment Directive (WEEE Directive) is the European Community Directive 2012/19/EU on collection, recycling and recovery targets for all types of electrical goods.
	The Restriction of Hazardous Substances Directive 2011/65/EU (RoHS 2) regulates the use of certain hazardous substances in electrical and electronic equipment.
	Registration, Evaluation, Authorisation and Restriction of Chemicals (REACH) is a European Union regulation that addresses the production and use of chemical substances, and their potential impacts on both human health and the environment.

Unless otherwise stated, all values are specified in normal mounting position, at full load, nominal input and output voltages, 25°C (77°F) ambient temperature and a run-in time of 5 minutes.

19. Typical use-cases

19.1 Parallel Operation

For the purpose of power increase, power supplies can be paralleled. The following measures must be taken into account:

- ▶ Only power supplies of the same series and power rating must be paralleled
- ▶ The dip switch on the front side of the power supplies must be switched to PARALLEL
- ▶ Load wiring shall be identical in terms of length and cross section
- ▶ The output voltage of the power supplies shall be adjusted to the same value ($\pm 100\text{mV}$)
- ▶ All paralleled power supplies must be operated under the same ambient conditions
- ▶ The power supplies must not be operated under any condition which requires a power derating (e.g. altitudes above 3000mASL (9842ftASL), temperatures above $55^\circ\text{C}_{\text{amb}}$ ($131^\circ\text{F}_{\text{amb}}$), mounting orientations other than the normal mounting position, etc.)
- ▶ If more than three power supplies are paralleled, each output must be protected by a decoupling module (e.g. TDK-Lambda DRM series), MCB, diode, or fuse
- ▶ The increased installation clearances must be considered (see „8. Installation clearances“ on page 14)

i In parallel operations the values of output load regulation, inrush currents, EMI, harmonic and leakage currents will increase.

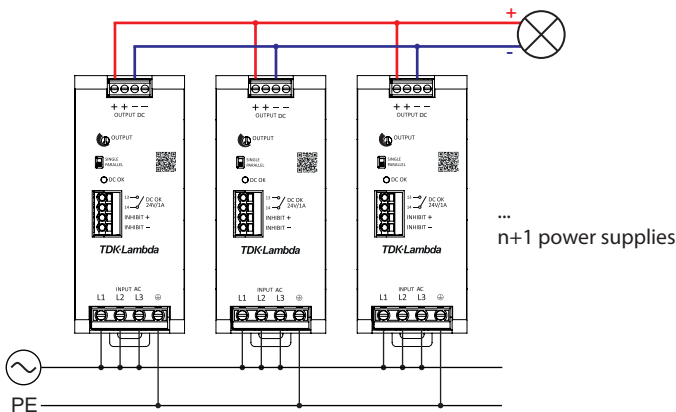

Fig. 27: Connection scheme of n+1 power supplies paralleled for the purpose of power increase

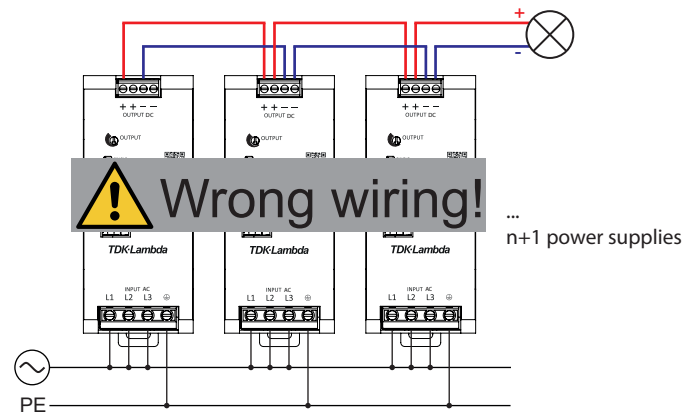

Fig. 28: Example of a wrong connection scheme

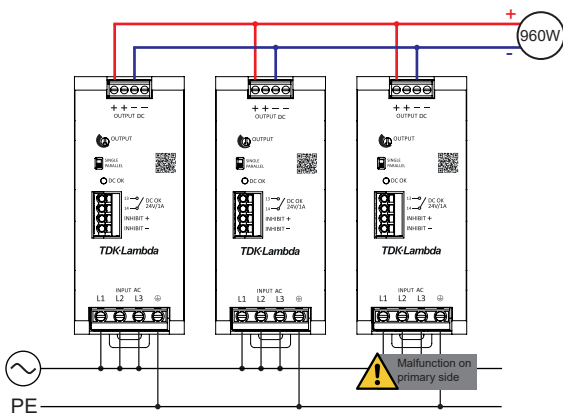

Fig. 29: Connection scheme of n+1 power supplies paralleled for the purpose of a 960W limited redundancy

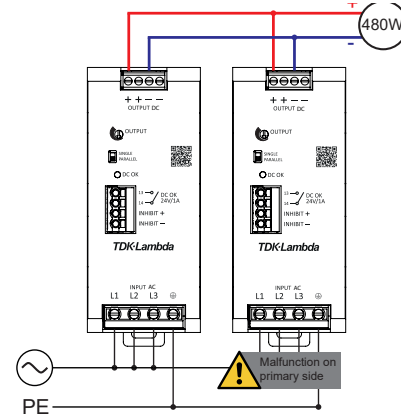

Fig. 30: Connection scheme of 1+1 power supplies paralleled for the purpose of a 480W limited redundancy

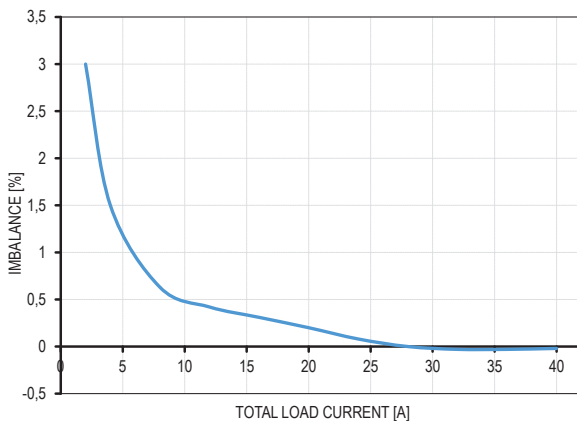

Fig. 31: Typical load sharing behaviour of two power supplies in parallel mode

Unless otherwise stated, all values are specified in normal mounting position, at full load, nominal input and output voltages, 25°C (77°F) ambient temperature and a run-in time of 5 minutes.

19.2 Series operation

For the purpose of higher load voltages, power supplies can be connected in series. The following measures must be taken into account:

- ▶ The output voltage sum must not exceed 250V_{DC}
- ▶ If the output voltage sum exceeds 60V_{DC}, a safeguard against unintended touching must be considered
- ▶ Only power supplies of the same series and power rating must be connected in series
- ▶ The dip switch on the front side of the power supplies must be switched to SINGLE
- ▶ All power supplies in series must be operated under the same ambient conditions
- ▶ The power supplies must not be operated under any condition which requires a power derating (e.g. altitudes above 3000mASL (9842ftASL), temperatures above 55°C_{amb} (131°F_{amb}), mounting orientations others than the normal mounting position, etc.)
- ▶ The increased installation clearances must be considered (see „8. Installation clearances“ on page 14)

i In series operations the values of output load regulation, inrush currents, EMI, harmonic and leakage currents will increase.

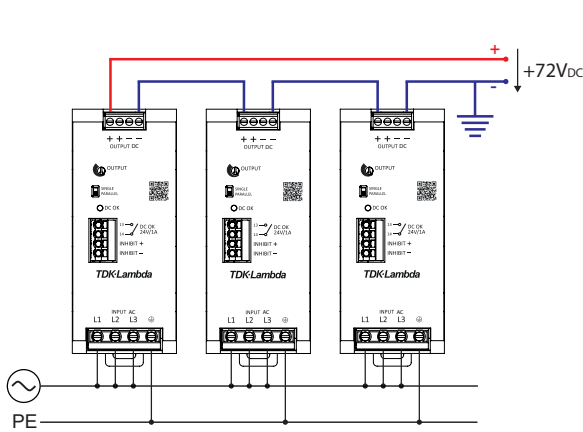

Fig. 32: Connection scheme for series operation with positive voltage level

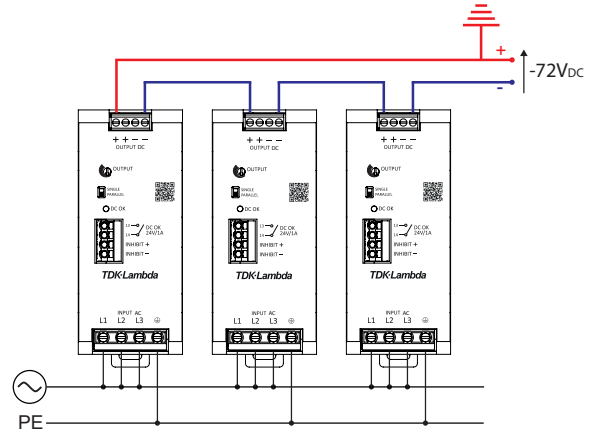

Fig. 33: Connection scheme for series operation with negative voltage level

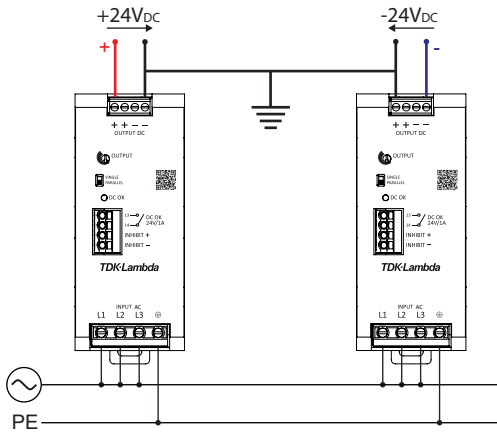

Fig. 34: Connection scheme for series operation with centre tap

19.3 Two-phase operation

The device is capable to run continuously on two phases of a 3-phase power grid. A power derating of min. 50% is required under nominal conditions. All conditions associated with a power derating must be carefully considered.

Please note if running on two phases:

- ▶ Power losses will increase and can no longer be guaranteed as specified for 3-phase operation
- ▶ Hold-up times as specified for 3-phase operation can no longer be guaranteed
- ▶ The device will go into OTP mode if operating permanently at input voltages below 350V_{AC}
- ▶ The device is no more compliant with IEC/EN 61000-3-2 harmonic current limits
- ▶ Safety approvals under UL 61010-1, -2-201 and UL 62368-1 (Ed.2) are no more applicable

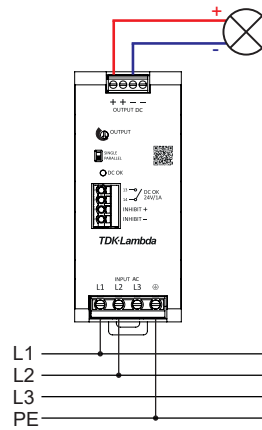

Fig. 35: Connection diagram for 2-phase operation



TDK-Lambda France SAS

Tel: +33 1 60 12 71 65
tff.fr-powersolutions@tdk.com
www.emea.lambda.tdk.com/fr



Italy Sales Office

Tel: +39 02 61 29 38 63
tff.it-powersolutions@tdk.com
www.emea.lambda.tdk.com/it



Netherlands

tff.nl-powersolutions@tdk.com
www.emea.lambda.tdk.com/nl



TDK-Lambda Germany GmbH

Tel: +49 7841 666 0
tfg.powersolutions@tdk.com
www.emea.lambda.tdk.com/de



Austria Sales Office

Tel: +43 2256 655 84
tfg.at-powersolutions@tdk.com
www.emea.lambda.tdk.com/at



Switzerland Sales Office

Tel: +41 44 850 53 53
tfg.ch-powersolutions@tdk.com
www.emea.lambda.tdk.com/ch



Nordic Sales Office

Tel: +45 8853 8086
tfg.dk-powersolutions@tdk.com
www.emea.lambda.tdk.com/dk

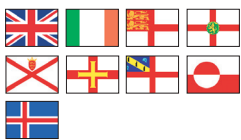

TDK-Lambda UK Ltd.

Tel: +44 (0) 12 71 85 66 66
tlu.powersolutions@tdk.com
www.emea.lambda.tdk.com/uk



TDK-Lambda Ltd.

Tel: +9 723 902 4333
tli.powersolutions@tdk.com
www.emea.lambda.tdk.com/il-en



TDK-Lambda Americas

Tel: +1 800-LAMBDA-4 or 1-800-526-2324
tla.powersolutions@tdk.com
www.us.lambda.tdk.com



TDK Electronics do Brasil Ltda

Tel: +55 11 3289-9599
sales.br@tdk-electronics.tdk.com
www.tdk-electronics.tdk.com/en



TDK-Lambda Corporation

Tel: +81-3-6778-1113
www.jp.lambda.tdk.com



TDK-Lambda (China) Electronics Co. Ltd.

Tel: +86 21 6485-0777
tlc.powersolutions@tdk.com
www.lambda.tdk.com.cn



TDK-Lambda Singapore Pte Ltd.

Tel: +65 6251 7211
tfs.marketing@tdk.com
www.sg.lambda.tdk.com



TDK India Private Limited, Power Supply Division

Tel: +91 80 4039-0660
mathew.philip@tdk.com
www.sg.lambda.tdk.com

For further information please visit:
emea.lambda.tdk.com/dr3-3-phase

