

# LED Flood Light IP65– 30W

Authorized Licensee for TOSHIBA trademark



## 1. Specification:

### A. General Data

Model	LED Flood Light 30W			
<b>P/N(Black shell)</b>	DELL-FL34030C5A011	DELL-FL44030C5A011	DELL-FL54030C5A011	DELL-FLC4030C5A011
<b>Westnet Code</b>	000172839	00172838	00172837	00172836
<b>P/N(White shell)</b>	DELL-FL34030C5A021	DELL-FL44030C5A021	DELL-FL54030C5A021	DELL-FLC4030C5A021
<b>Westnet Code</b>	00173311	00172310	00172309	00172308
<b>Rated Voltage</b>	230 VAC	230 VAC	230 VAC	230 VAC
<b>Frequency</b>	50 Hz	50 Hz	50 Hz	50 Hz
<b>Rated Wattage</b>	30 W	30 W	30 W	30 W
<b>Deviation Tolerance of Wattage</b>	±10 %	±10 %	±10 %	±10 %
<b>Displacement factor (cos φ1)*</b>	0.9(typical)	0.9(typical)	0.9(typical)	0.9(typical)
<b>Rated Current</b>	0.128A	0.128A	0.128A	0.128A
<b>Maximum Input Current</b>	0.147A	0.147A	0.147A	0.147A
<b>Start On</b>	<0.5S	<0.5S	<0.5S	<0.5S
<b>Warm up time</b>	<1S	<1S	<1S	<1S
<b>Dimmable</b>	NO	NO	NO	NO
<b>Beam Angle</b>	120°	120°	120°	120°
<b>Peak luminous intensity (cd)</b>	1110	1110	1110	1110

<b>R9 CRI</b>	>1	>1	>1	>1
<b>Survival factor</b>	90%	90%	90%	90%
<b>Safety requirements</b>	CE	CE	CE	CE
<b>Lumen Maintenance factor</b>	96%	96%	96%	96%
<b>Stroboscopic effect metric (SVM)**</b>	No Claimed	No Claimed	No Claimed	No Claimed
<b>Flicker metric (PstLM)**</b>	No Claimed	No Claimed	No Claimed	No Claimed
<b>Energy Efficiency Class(EEC)</b>	F	F	F	F
<b>Applicable Environments</b>	IP65	IP65	IP65	IP65
<b>Exchangeable LED Module</b>	NO	NO	NO	NO
<b>Photobiological Group</b>	RG 0	RG 0	RG 0	RG 0
<b>Safety class</b>	Class I	Class I	Class I	Class I

\* Displacement factor tolerance +/- 10%

\*\*In accordance with (EU)2019/2020 of SVM  $\leq 0,4$  at full-load (except for HID with  $\Phi_{use} > 4$  klm and for light sources intended for use in outdoor applications, industrial applications or other applications where lighting standards allow a CRI < 80)

## B. Light Data

<b>Color</b>	Warm White	Natural White	Daylight	Cool White
<b>Color Temperature (CCT)</b>	3000K	4000K	5000K	6500K
<b>Useful luminous flux*</b>	2450 lm			
<b>Total luminous flux*</b>	2700 lm			
<b>Color Rendering Index*</b>	80			
<b>Efficacy ( Useful )*</b>	81.6 lm/W	81.6 lm/W	81.6 lm/W	81.6 lm/W
<b>Efficacy ( Total )*</b>	90 lm/W	90 lm/W	90 lm/W	90 lm/W
<b>Color Consistency**</b>	6 Step MacAdam Ellipse (6 SDCM)			

\* tolerance +/- 10%

\*\* 3000K center point (0.43387, 0.40319) ; 4000K center point (0.38177, 0.37959) ; 5000K center point (0.34464, 0.35506) ; 6500K center point (0.31230, 0.32825)

### C. Lifetime

(Supplied Voltage: AC 230V ; Ambient Temperature: 25°C)

<b>Lumen Maintenance Factor</b>	70% of the rated lifetime
<b>Rated Lifetime – L<sub>70</sub>B<sub>50</sub></b>	15,000 hrs
<b>Switch cycles</b>	≥ 15,000

### D. Temperature Operation

<b>Normal operation temperature</b>	-20°C ~ 40°C
<b>Relative Humidity</b>	10% ~ 90%

### E. Geometric Data

<b>Model</b>	LED Flood Light 30W
<b>Maximum overall length</b>	153.2 ± 2 mm ( 6.03 ± 0.08 inch )
<b>Maximum overall width</b>	164.4 ± 2 mm ( 6.47 ± 0.08 inch )
<b>Maximum overall thickness</b>	21.2 ± 2 mm ( 0.83 ± 0.08 inch )
<b>Mass</b>	410 g± 35g

### F. Environmental relevant materials

<b>Mercury (Hg)</b>	Comply with RoHS Directive 2011/65/EU
<b>Lead (Pb)</b>	
<b>Cadmium(Cd)</b>	
<b>Hexavalent Chromium(Cr6+)</b>	
<b>Polybrominated Biphenyls(PBBs)</b>	
<b>Polybrominated Diphenyl Ethers(PBDEs)</b>	
<b>Bis (2-ethylhexyl) phthalate(DEHP)</b>	
<b>Butyl benzyl phthalate(BBP)</b>	
<b>Dibutyl phthalate(DBP)</b>	
<b>Diisobutyl phthalate(DIBP)</b>	

## 2. Outline Drawing

Unit : mm

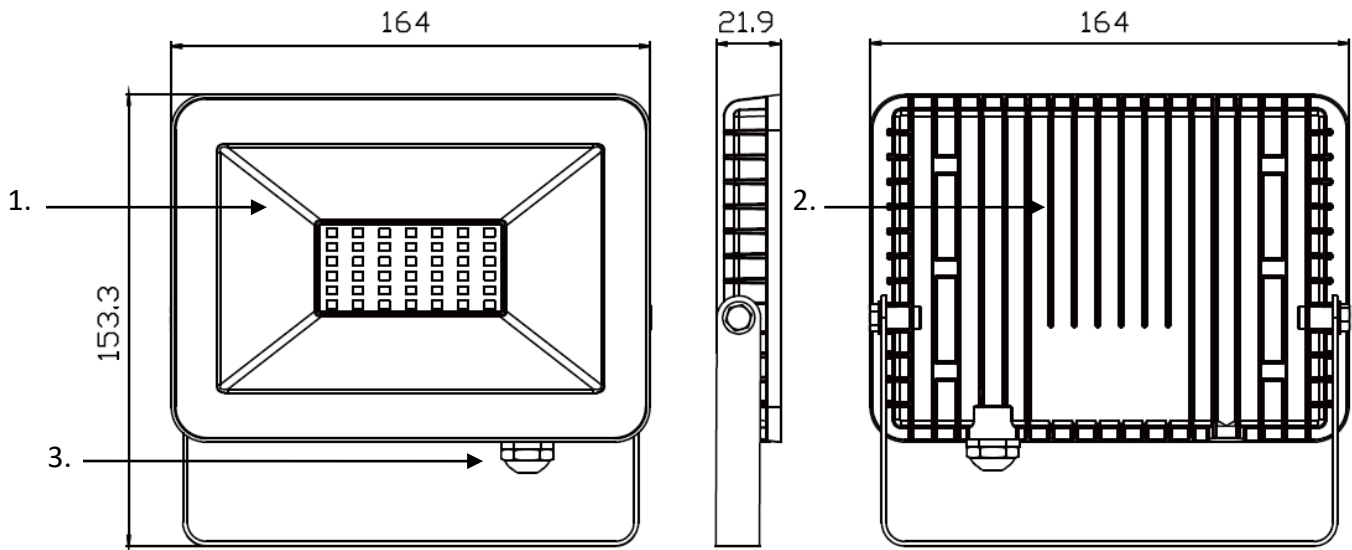

### Material Information

- 1. Cover: Glass
- 2. Body: Metal
- 3. Gland: Metal

## 3. Light Distribution Curve

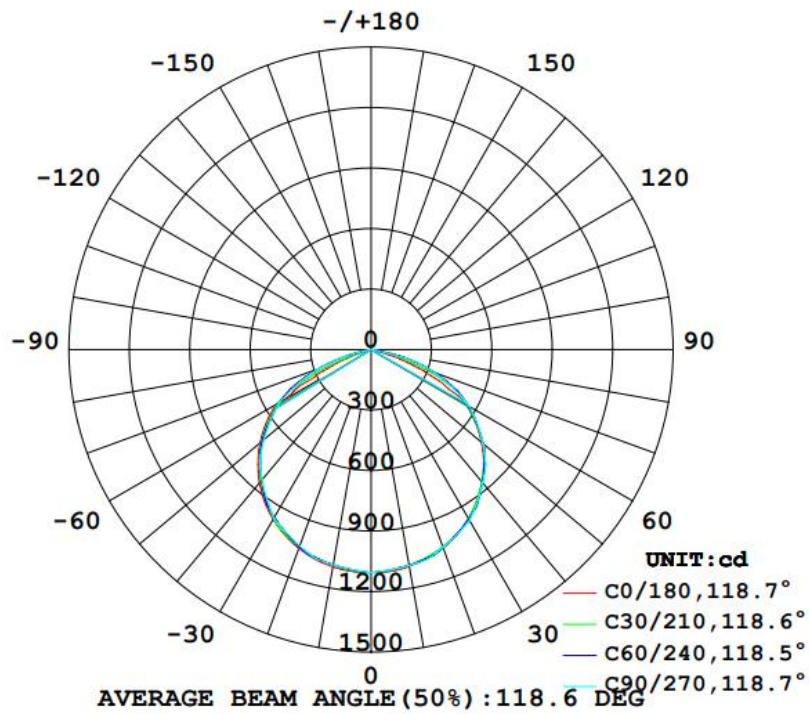

## 4. Spectrum Distribution

### ● 3000K Color Temperature

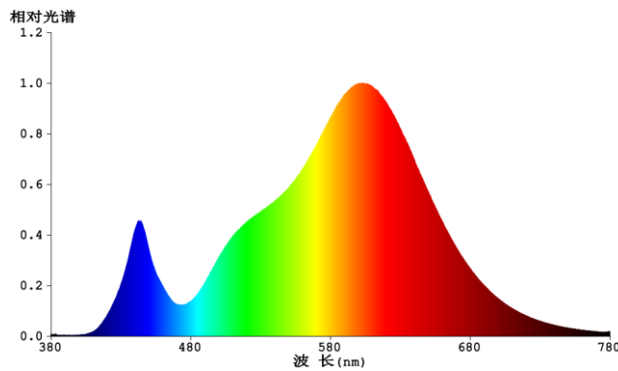

### ● 4000K Color Temperature

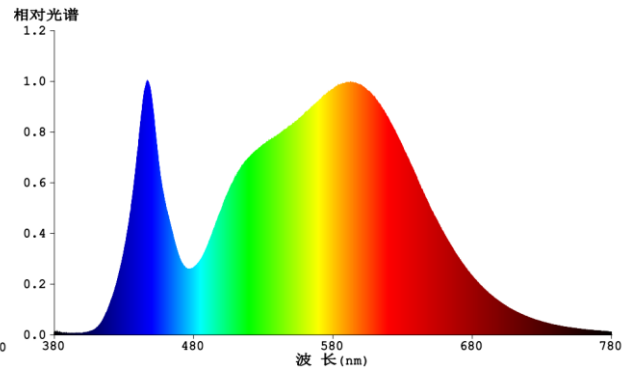

### ● 5000K Color Temperature

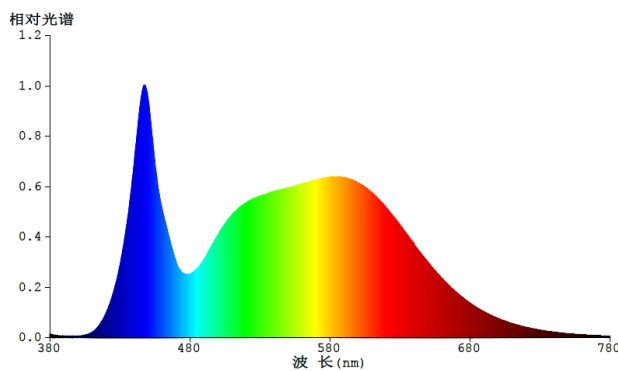

### ● 6500K Color Temperature

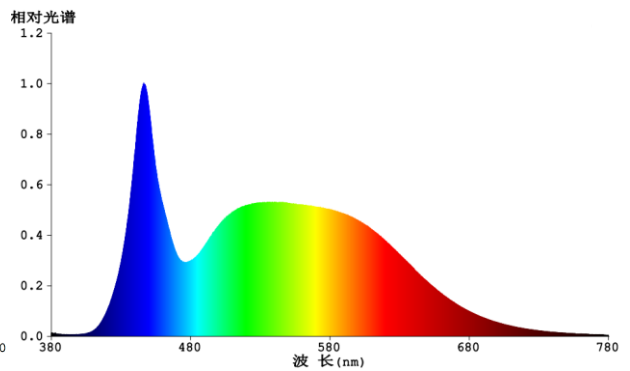

## 5. Warnings

- Before replacing, turn off power and let high bay cool to avoid electrical shock or burn.
- Do not touch electronic components, electronic components maybe under high voltage.
- Do not stare into LED light beam
- The luminaire shall be installed by a qualified electrician and wired in accordance with the latest IEE electrical regulations or the national requirements.

## 6. Cautions

Only to apply in dry and most of open fixtures with lamp-holders that offer sufficient space (10 mm free air space). Not intended for use with emergency light fixtures for exit lights.

## 7. Notes

All characteristics are estimated at room temperature (25°C), free air burning, base up burning position and at rated voltage. In view of the complex manufacturing process for light above for the technical LED parameters are merely statistical values that do not necessarily correspond to the actual technic individual products may vary from the typical values.

## 8. Logistic information

Model	LED Flood Light 30W 3000K	LED Flood Light 30W 4000K	LED Flood Light 30W 5000K	LED Flood Light 30W 6500K
Pieces per pack	1	1	1	1
EAN code on pack -Black shell	4711112386147	4711112384006	4711112385508	4711112386130
EAN code on pack -White shell	4711112388653	4711112388646	4711112388639	4711112388622
Size of pack	173x25x159mm	173x25x159mm	173x25x159mm	173x25x159mm
Weight per pack (G.W)	0.45kg	0.45kg	0.45kg	0.45kg
Packs per inner box	N/A	N/A	N/A	N/A
EAN code on inner box	N/A	N/A	N/A	N/A
ITF code on inner box	N/A	N/A	N/A	N/A
Size of inner box	N/A	N/A	N/A	N/A
Weight per inner box(G.W)	N/A	N/A	N/A	N/A
Packs per outer box	20	20	20	20
EAN code on outer box	N/A	N/A	N/A	N/A
ITF code on outer box -Black shell	14711112386144	14711112384003	14711112385505	14711112386137
ITF code on outer box -White shell	14711112388650	14711112388643	14711112388636	14711112388629
Size of outer box	360x145x338mm	360x145x338mm	360x145x338mm	360x145x338mm
Weight per outer box(G.W)	9.5Kg	9.5Kg	9.5Kg	9.5Kg

Package box

3000K



4000K



5000K



6500K



## 9. ERP Label

DELL-FL34030C5A011 / DELL-FL34030C5A011 / DELL-FL54030C5A011 / DELL-FLC4030C5A011

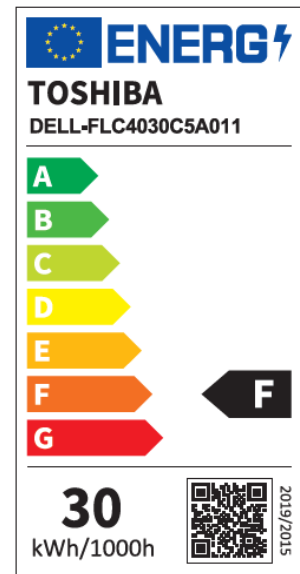
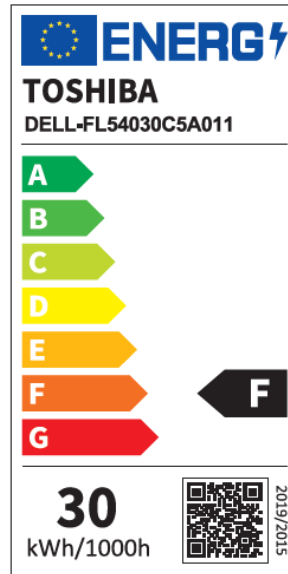
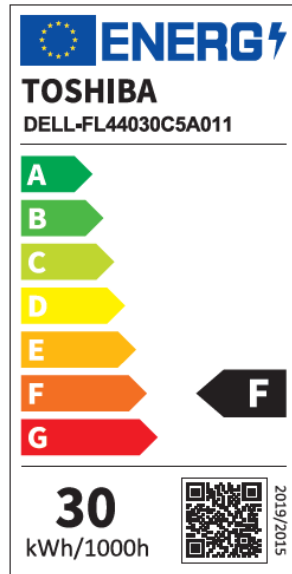
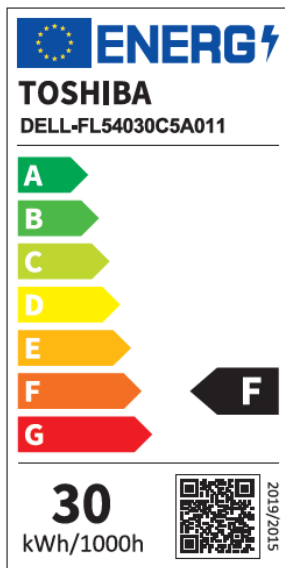

DELL-FL34030C5A021 / DELL-FL44030C5A021 / DELL-FL54030C5A021 / DELL-FLC4030C5A021

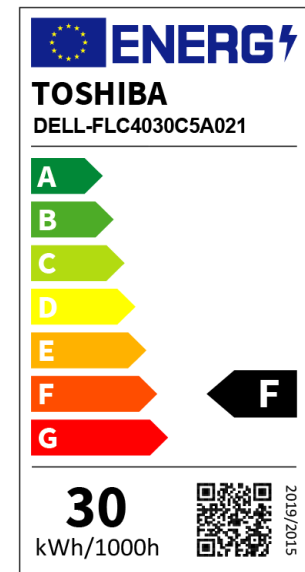
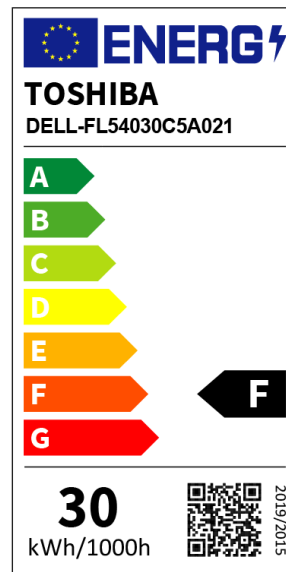
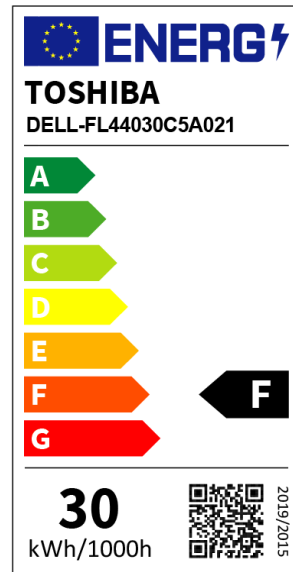
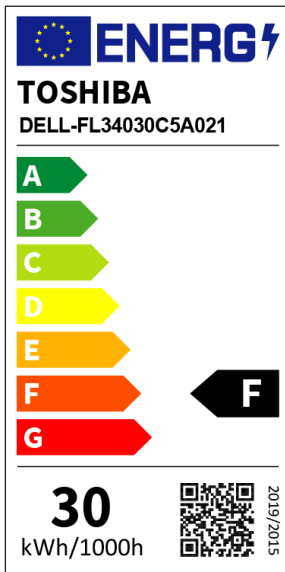



**10. Conformity**

<b>2014/35/EU; Low Voltage Directive</b>	EN 60598-2-5: 2015 ; EN IEC 60598-1: 2021 ; IEC/TR 62778:2014 ; EN 62493:2015 ; EN IEC 62031:2020
<b>2014/30/EU; EMC Directive</b>	EN IEC 55015: 2019+A11:2020 、 EN IEC 61000-3-2:2019+A1:2021 、 EN 61000-3-3: 2013+A2:2021 、 EN 61547: 2009
<b>2009/125/EC; ErP Directive</b>	(EU) 2019/2015 、 (EU) 2019/2020 、 (EU) 2021/340 、 (EU) 2021/341
<b>2011/65/EU+(EU)2015/863; RoHS Directive</b>	EN 50581: 2012