

CLICKER 2

PIC32MX

a fast click™ board two-seater

A compact starter kit
with your favorite
microcontroller and two
mikroBUS™ sockets

TO OUR VALUED CUSTOMERS

I want to express my thanks to you for being interested in our products and for having confidence in MikroElektronika.

The primary aim of our company is to design and produce high quality electronic products and to constantly improve the performance thereof in order to better suit your needs.

A stylized, handwritten signature in white ink, consisting of several overlapping loops and a long horizontal stroke extending to the right.

Nebojsa Matic
General Manager

Table of contents

Introduction to clicker 2 for PIC32MX	4	3.2 Programming with mikroProg™ programmer	15
Key features	5	mikroProg Suite™ for PIC® software	16
1. Power supply	7	4. Buttons and LEDs	18
2. PIC32MX460F512L microcontroller	9	5. Power management and battery charger	20
Key microcontroller features	9	6. Oscillators	21
3. Programming the microcontroller	10	7. USB connection	23
3.1 Programming with mikroBootloader	11	8. Pads	25
step 1 - Connecting clicker 2 for PIC32MX	11	9. Pinout	26
step 2 - Browsing for .HEX file	12	9.1 PWM jumper selection	27
step 3 - Selecting .HEX file	12	9.2 RF3/USBID jumper selection	28
step 4 - Uploading .HEX file	13	10. click™ boards are plug and play!	29
step 5 - Finish upload	14	11. Dimensions	31

Introduction to clicker 2 for PIC32MX

Clicker 2 for PIC32MX is a compact dev. kit with two mikroBUS™ sockets for click™ board connectivity. You can use it to quickly build your own gadgets with unique functionalities and features. It carries the PIC32MX460F512L, a 32-bit MIPS M4K core PIC32 microcontroller, two indication LEDs, two general purpose buttons, a reset button, an on/off switch, a li-polymer battery connector, a USB Mini-B connector and two mikroBUS™ socket. A mikroProg connector and a 2x26 pinout for interfacing with external electronics

are also provided. The mikroBUS™ connector consists of two 1x8 female headers with SPI, I²C, UART, RST, PWM, Analog and Interrupt lines as well as 3.3V, 5V and GND power lines. Clicker 2 for PIC32MX board can be powered over a USB cable.



power supply
via USB cable
(5V DC)



board dimensions
60.4 x 81 mm
(2.4 x 3.2 inch)



weight
26 g (0.057 lbs)

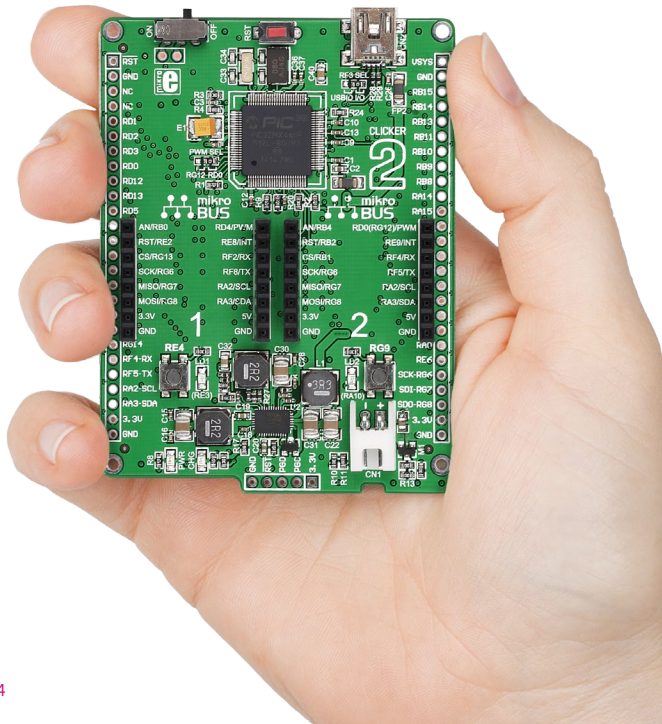

Key features

- 1 ON/OFF switch
- 2 Pads for connecting external ON/OFF switch
- 3 32.768 KHz crystal oscillator
- 4 8 MHz crystal oscillator
- 5 PIC32MX460F512L
- 6 2x26 connection pads
- 7 mikroBUS™ sockets 1 and 2
- 8 Pushbuttons
- 9 Additional LEDs
- 10 LTC3586-1 USB power manager IC
- 11 Power and Charge indication LEDs
- 12 RESET button
- 13 USB mini-B connector
- 14 Li-Polymer battery connector
- 15 Programmer connector

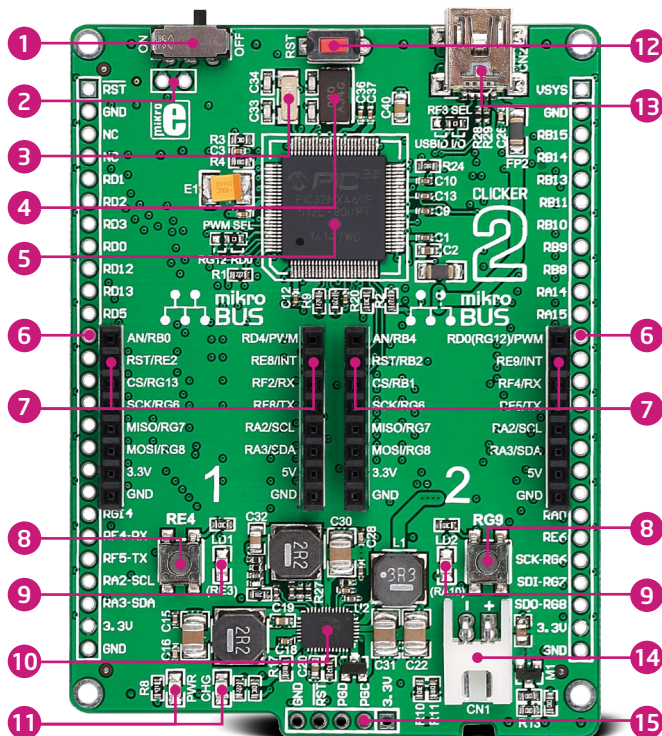

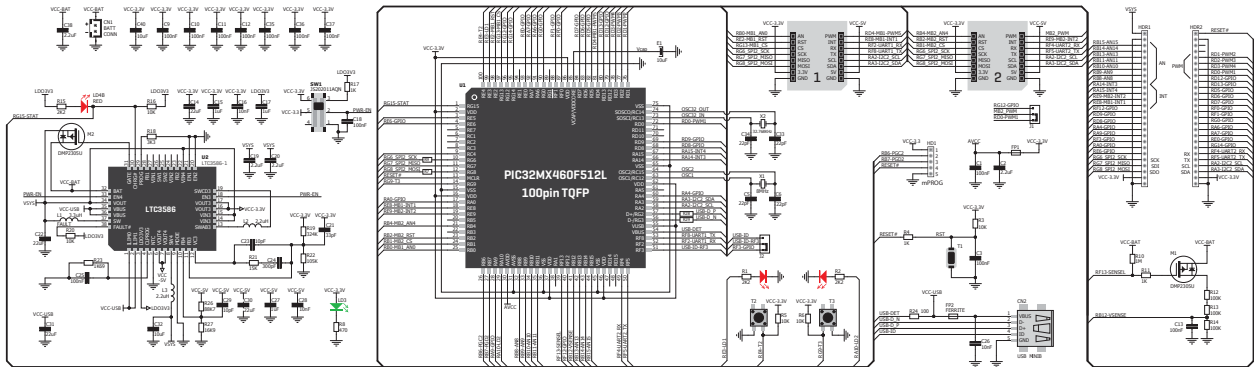

clicker 2 for PIC32MX schematic

1. Power supply

Figure 1-1: Connecting USB power supply

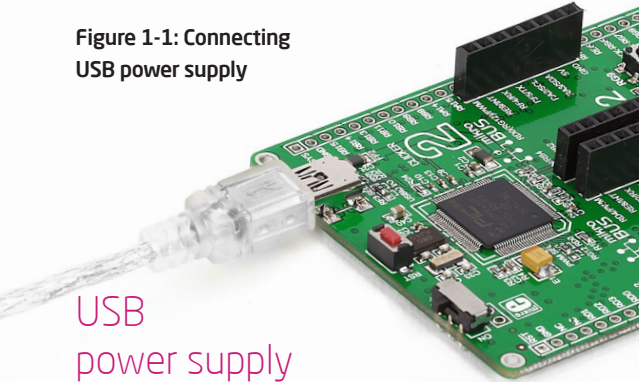

You can supply power to the board with a **Mini-B USB** cable provided in the package. On-board voltage regulators provide the appropriate voltage levels to each component on the board. **Power LED (GREEN)** will indicate the presence of power supply.

NOTE | *click™ boards that use a 3.3V power supply can draw up to 750 mA of current, which is more current than a USB can supply (500 mA); In those cases you would need to use the battery as the power supply, or the vsys pin on the side of the board.*

Battery power supply

You can also power the board using a **Li-Polymer** battery, via on-board battery connector. On-board battery charger circuit enables you to charge the battery over USB connection. **LED diode (RED)** will indicate when battery is charging. Charging current is ~300mA and charging voltage is 4.2V DC.

Figure 1-2: Connecting Li-Polymer battery

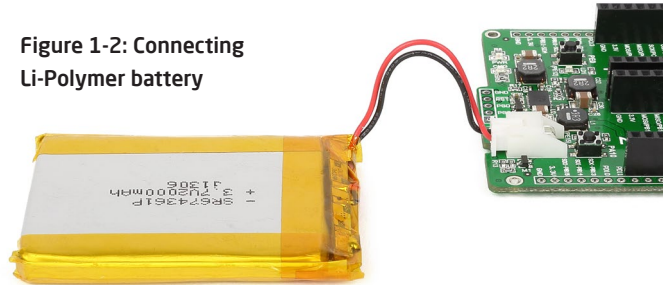

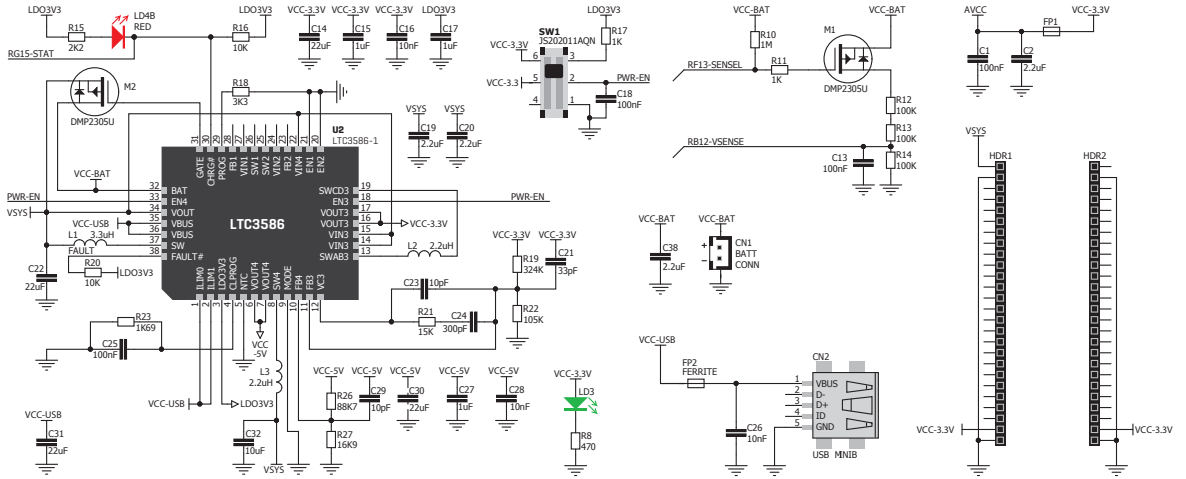

Figure 1-3: Power supply schematic

2. PIC32MX460F512L microcontroller

The PIC32MX clicker development tool comes with the **PIC32MX460F512L** microcontroller. This 32-bit MIPS M4K Core high performance microcontroller is rich with on-chip peripherals and features 512KB of Flash and 32KB RAM. It has integrated full speed USB 2.0. support.

Key microcontroller features

- 105 DMIPS/ 80MHz, 32-bit MIPS M4K Core;
- 512K Flash (plus 12K boot Flash);
- 32K RAM (can execute from RAM);
- 85 I/O pins;
- SPI, I²C, A/D, UART;
- 16-bit, 32-bit Digital Timers;
- Internal Oscillator 8MHz, 32kHz;
- RTCC; etc.

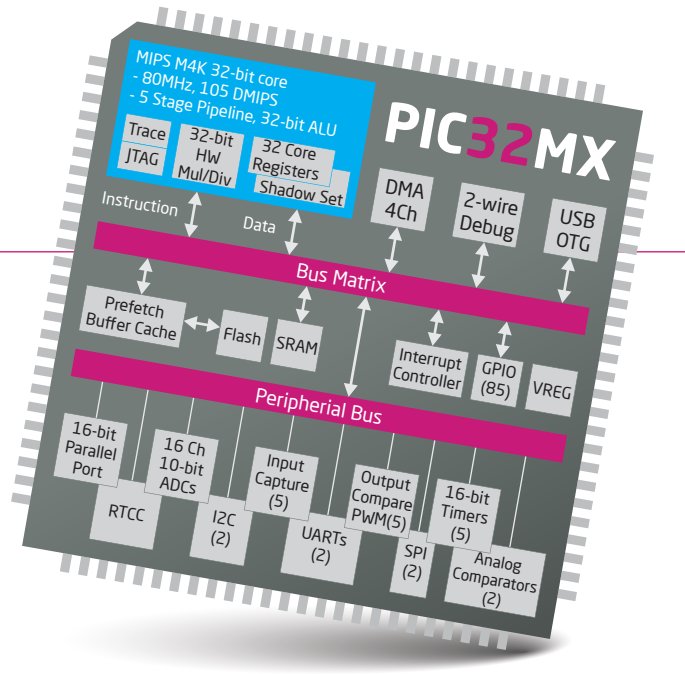

3. Programming the microcontroller

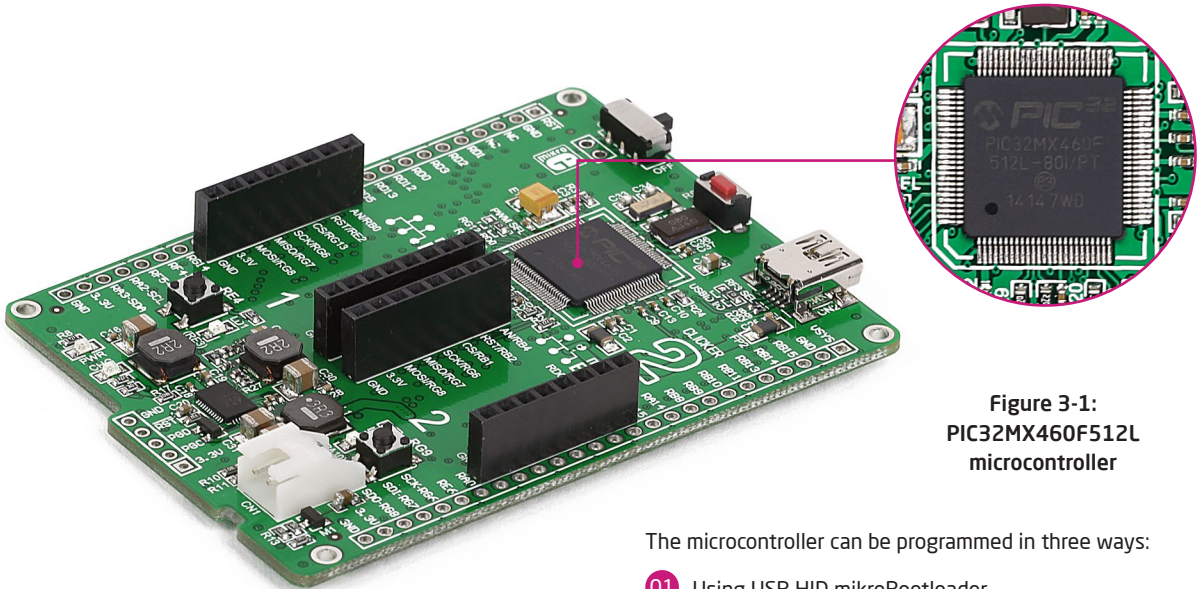

Figure 3-1:
PIC32MX460F512L
microcontroller

The microcontroller can be programmed in three ways:

- 01** Using USB HID mikroBootloader,
- 02** Using external mikroProg™ for PIC32MX programmer
- 03** Using external ICD2/3® programmer

3.1 Programming with mikroBootloader

You can program the microcontroller with bootloader which is preprogrammed by default. To transfer .hex file from a PC to MCU you need bootloader software (**mikroBootloader USB HID**) which can be downloaded from:

➔ www.mikroe.com/downloads/get/2210/clicker_2_pic32mx_bootloader_v100.zip

After the mikroBootloader software is downloaded, unzip it to desired location and start it.

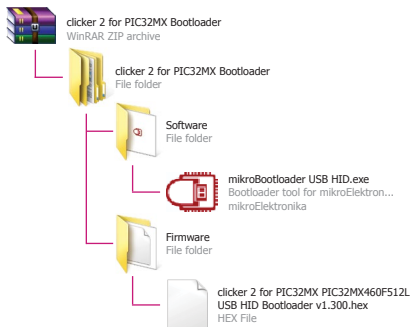

step 1 - Connecting PIC32MX clicker



Figure 3-2: USB HID mikroBootloader window

01 To start, connect the USB cable, or if already connected press the **Reset** button on your PIC32MX clicker. Click the **Connect** button within 5s to enter the bootloader mode, otherwise existing microcontroller program will execute.

step 2 – Browsing for .HEX file



Figure 3-3: Browse for HEX

- 01 Click the **Browse for HEX** button and from a pop-up window (**Figure 3.4**) choose the .HEX file which will be uploaded to MCU memory.

step 3 – Selecting .HEX file

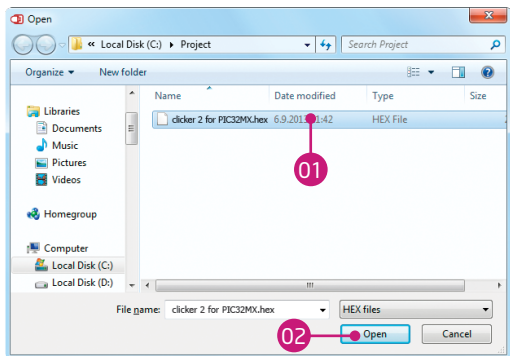

Figure 3-4: Selecting HEX

- 01 Select .HEX file using open dialog window.
- 02 Click the **Open** button.

step 4 – Uploading .HEX file



Figure 3-5: Begin uploading

- 01** To start .HEX file bootloading click the **Begin uploading** button.



Figure 3-6: Progress bar

- 01** Progress bar enables you to monitor .HEX file uploading.

step 5 – Finish upload

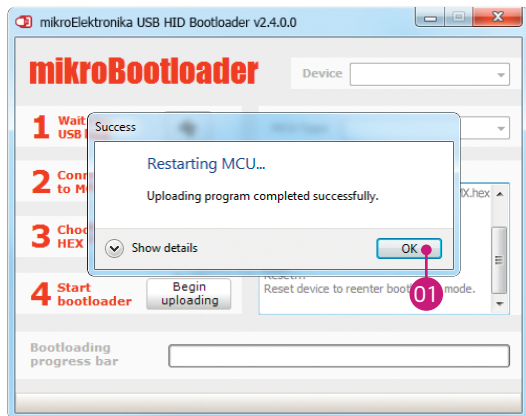

Figure 3-7: Restarting MCU

- 01 Click **OK** button after the uploading process is finished.
- 02 Press **Reset** button on PIC32MX clicker board and wait for 5 seconds. Your program will run automatically.



3.2 Programming with mikroProg™ programmer

The microcontroller can be programmed with external **mikroProg™ for PIC programmer** and **mikroProg Suite™ for PIC® software**. The external programmer is connected to the development system via 1x5 connector **Figure 3-9**. **mikroProg™** is a fast USB 2.0 programmer with hardware debugger support. It supports PIC10®, dsPIC30/33®, PIC24® and PIC32® devices in a single programmer. It supports over 570 microcontrollers from Microchip®. Outstanding performance, easy operation and elegant design are its key features.

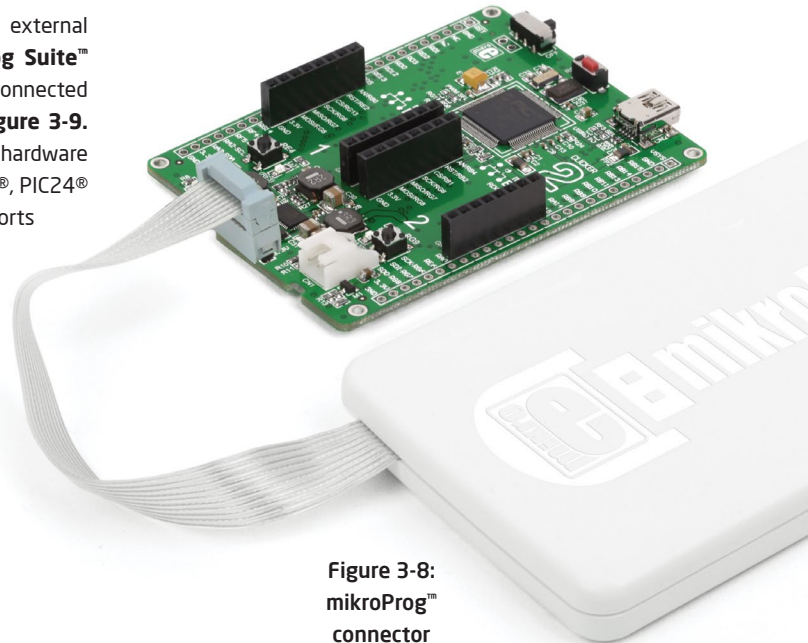

You can also program it with ICD2® or ICD3® if you reroute the wires like shown here.

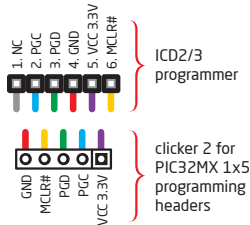

Figure 3-8:
mikroProg™
connector

mikroProg Suite™ for PIC® Software



The **mikroProg™** programmer requires special programming software called **mikroProg Suite™ for PIC®**. It can be used for programming all Microchip® microcontroller families, including PIC10®, PIC12®, PIC16®, PIC18®, dsPIC30/33®, PIC24® and PIC32®. The software has intuitive interface and SingleClick™ programming technology. Just download the latest version of **mikroProg Suite™** and your programmer is ready to program new devices. **mikroProg Suite™** is updated regularly, at least four times a year, so your programmer will be more and more powerful with each new release.

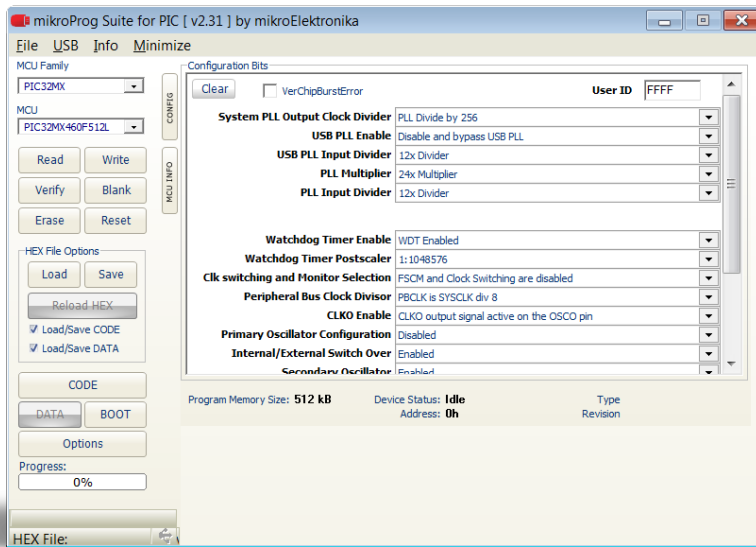

Figure 3-9: Main window of mikroProg Suite™ for PIC® programming software

NOTE Before attaching the programming connector, you have to solder the provided 1x5 male header to the programming pads (HD1).

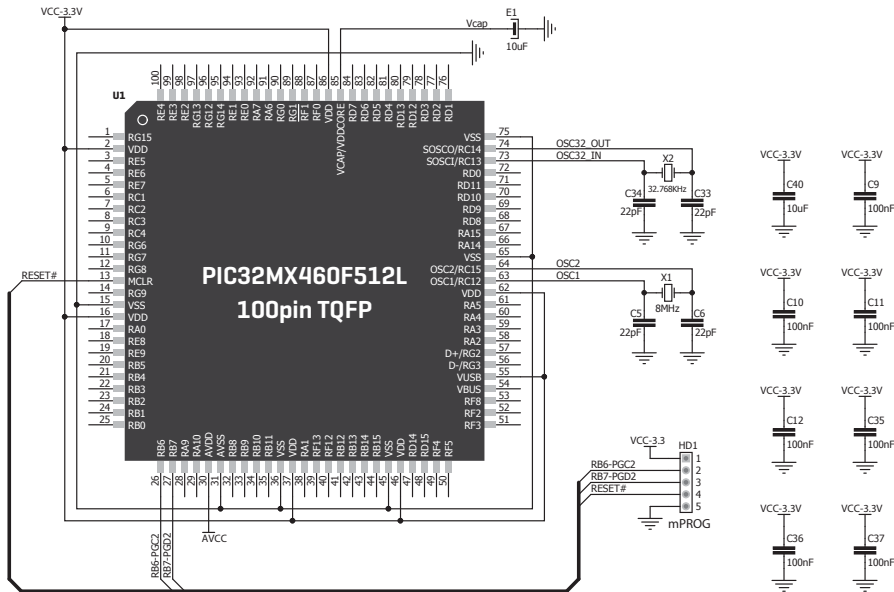

Figure 3-10: mikroProg™ connection schematic

4. Buttons and LEDs

The board also contains a **01 reset button** and a pair of **02 buttons** and **03 LEDs**, as well as an ON/OFF switch. The **Reset button** is used to manually reset the microcontroller by generating a low voltage level on the microcontroller's reset pin. **LEDs** can be used for visual indication of the logic state on two pins (**RE3**) and (**RA10**). An active LED indicates that a logic high (1) is present on the pin. Pressing any of the two **buttons** can change the logic state of the microcontroller pins (**RE4** and **RG9**) from logic high (1) to logic low (0). In addition to the onboard ON/OFF switch, two pads (EXT and PSW) allow you to connect your own external switch.

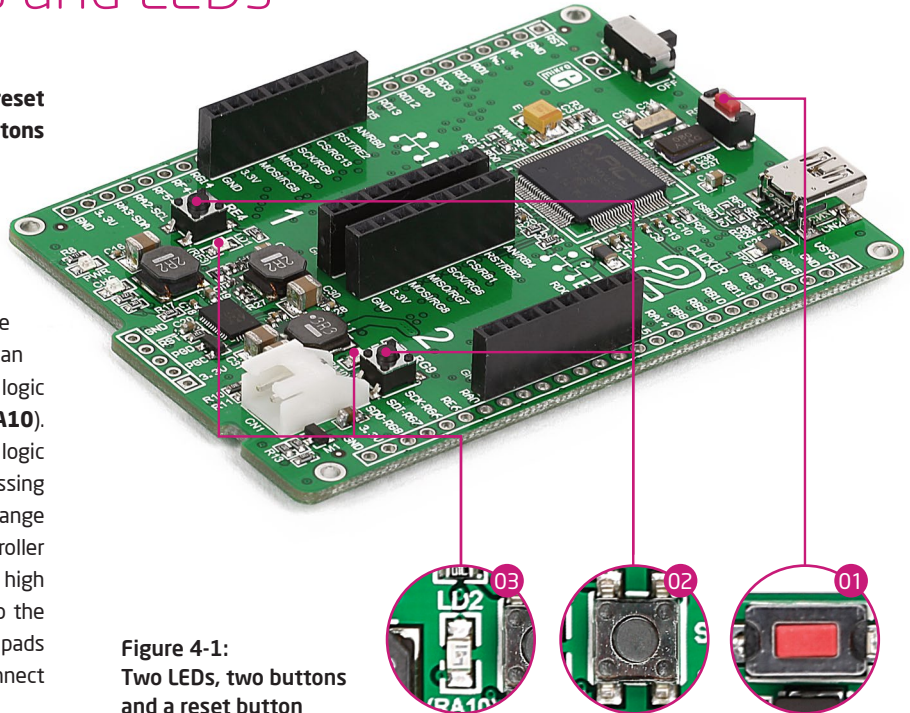

Figure 4-1:
Two LEDs, two buttons
and a reset button

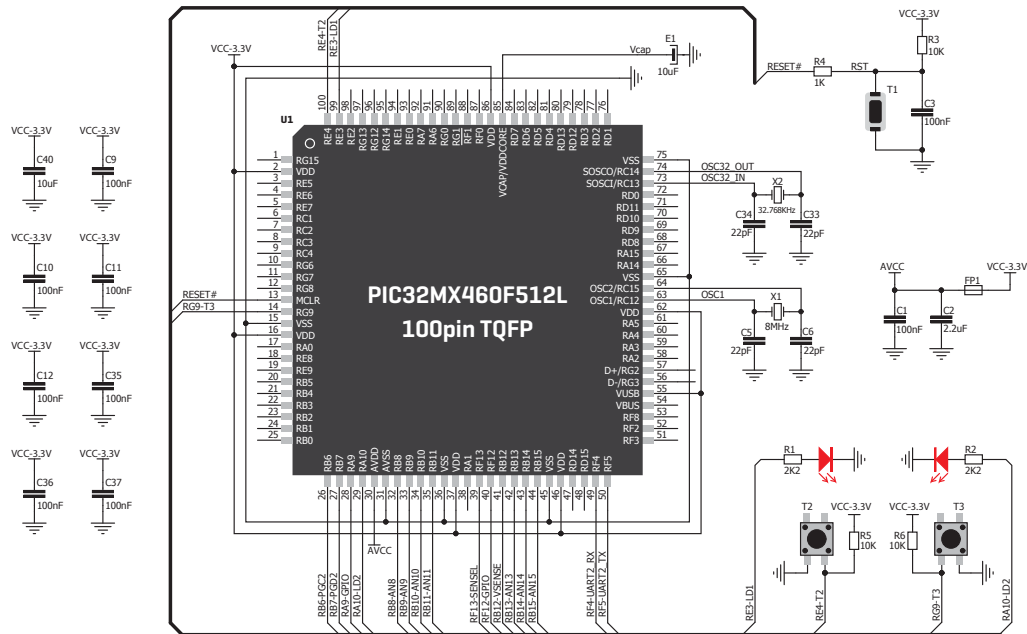

Figure 4-2: Other modules connection schematic

5. Power management and battery charger

Clicker 2 for PIC18FJ features

LTC®3586-1, a highly integrated power management and battery charger IC that includes a current limited switching PowerPath manager. LTC®3586 also **enables battery charging over a USB connection**.

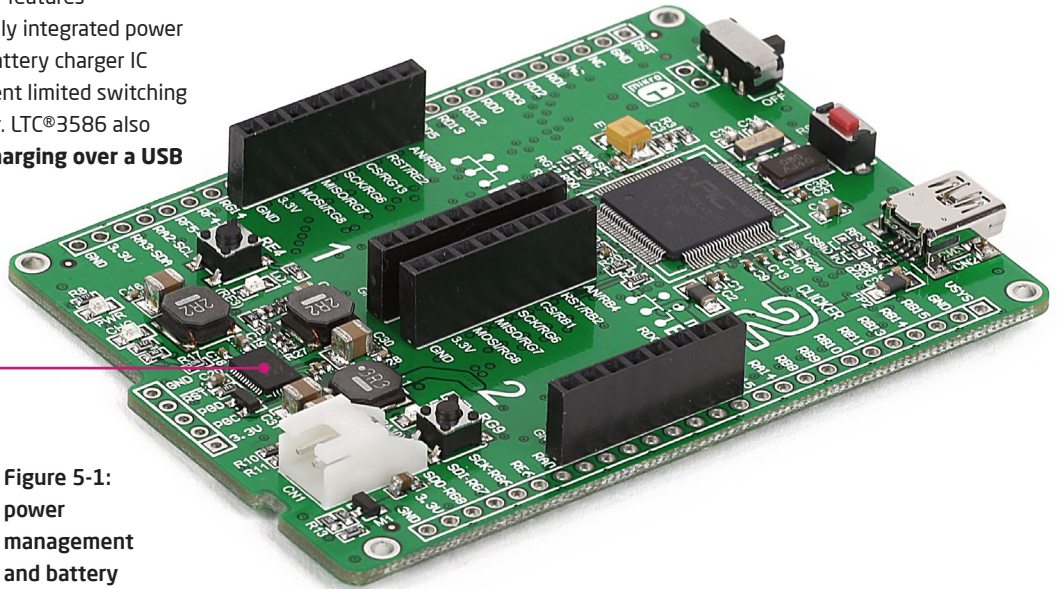
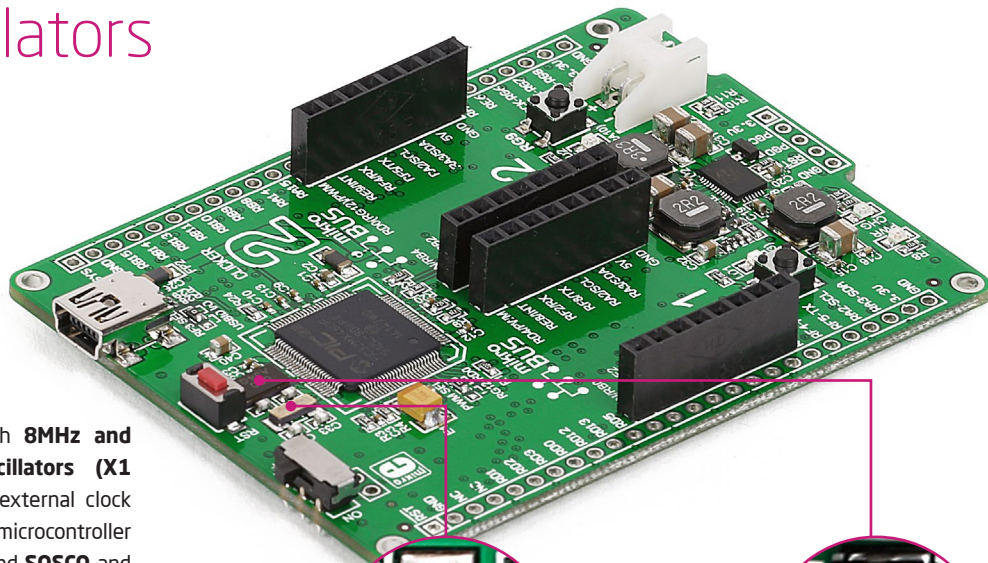

Figure 5-1:
power
management
and battery
charger IC

6. Oscillators



Board is equipped with **8MHz** and **32.7kHz** crystal oscillators (**X1** and **X2**) that provide external clock waveforms to the microcontroller **OSC2** and **OSC1** (X1) and **SOSCO** and **SOSCI** (X2) pins. This base frequency is suitable for further clock multipliers and ideal for generation of necessary USB clock, which ensures proper operation of bootloader and your custom USB-based applications.

Figure 6-1:
32.768kHz
crystal
oscillator
module (X2)

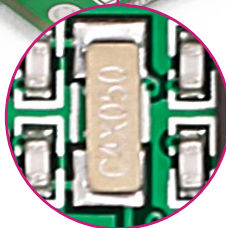
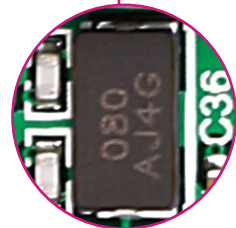

Figure 6-2:
8MHz
crystal
oscillator
module (X1)



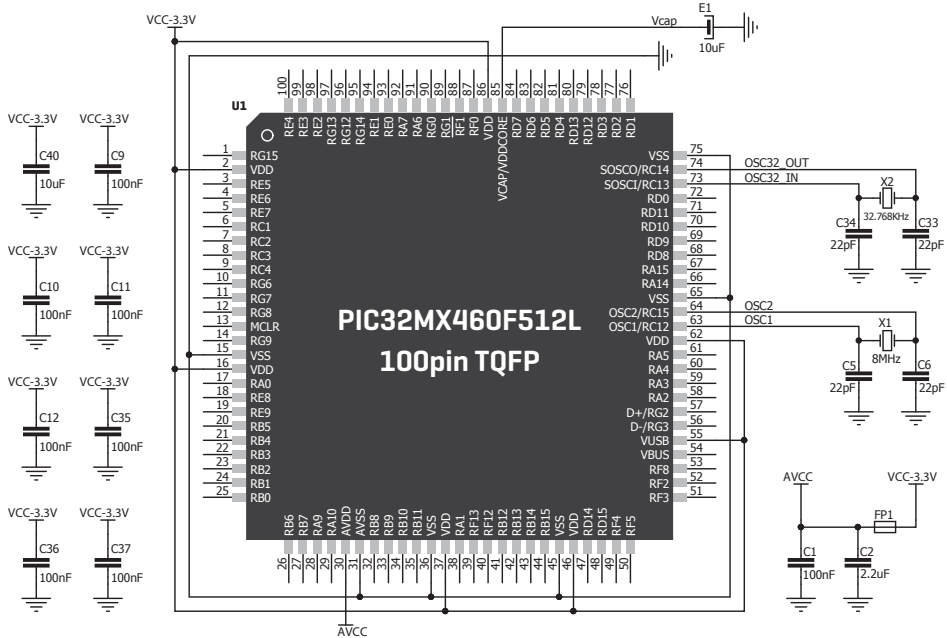

Figure 6-3:
Crystal oscillator schematic

NOTE | *The use of crystal in all other schematics is implied even if it is purposely left out, because of the schematics clarity.*

7. USB connection

PIC32MX460F512L microcontrollers has an integrated USB module, which enables you to implement USB communication functionality to your clicker 2 board. Connection with target USB host is done over a Mini-B USB connector which is positioned next to the battery connector.

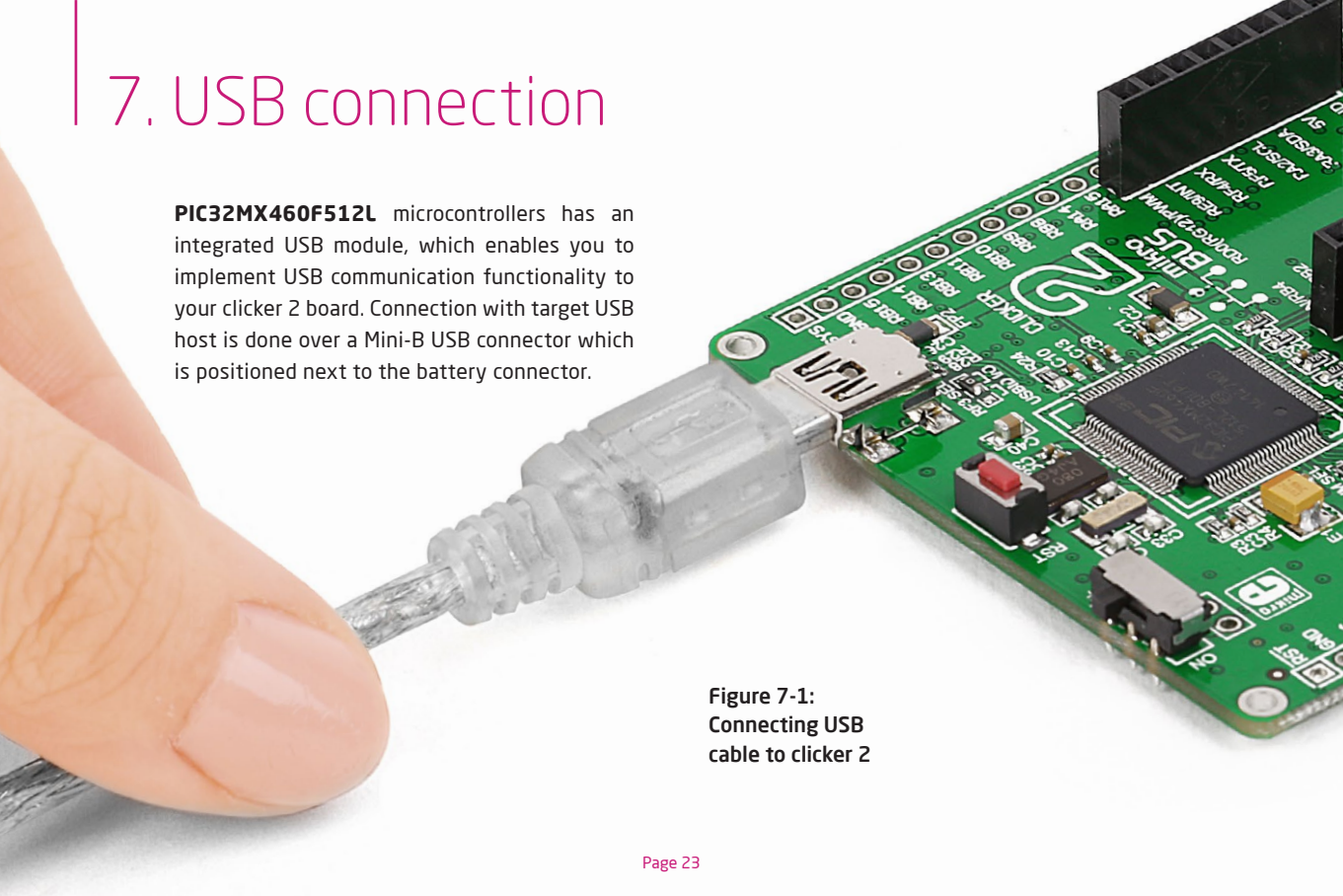

Figure 7-1:
Connecting USB
cable to clicker 2

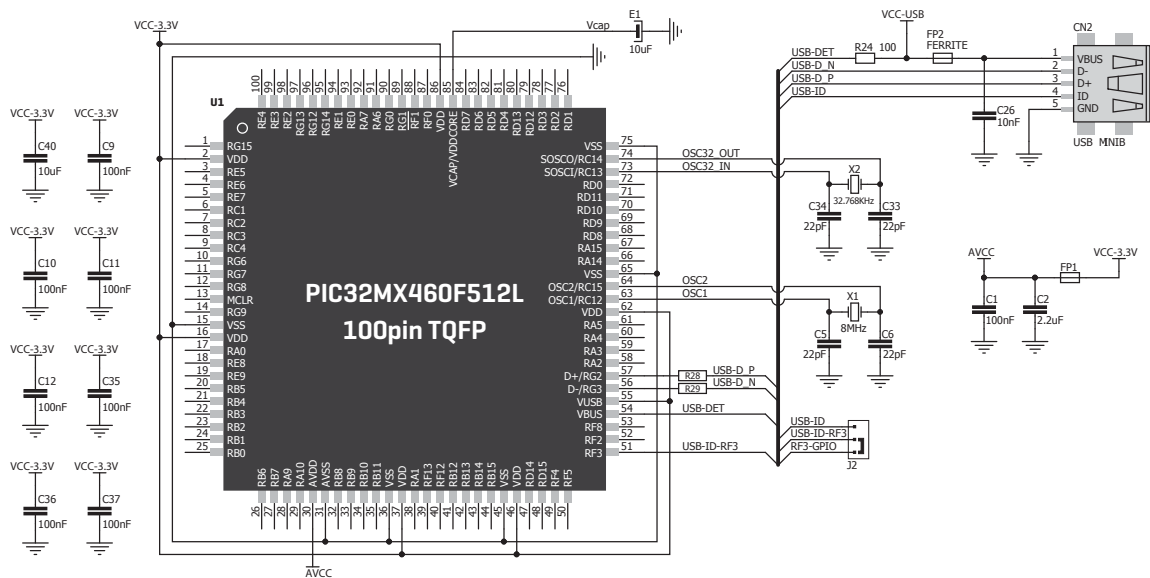
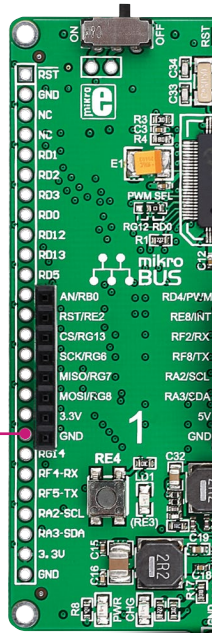
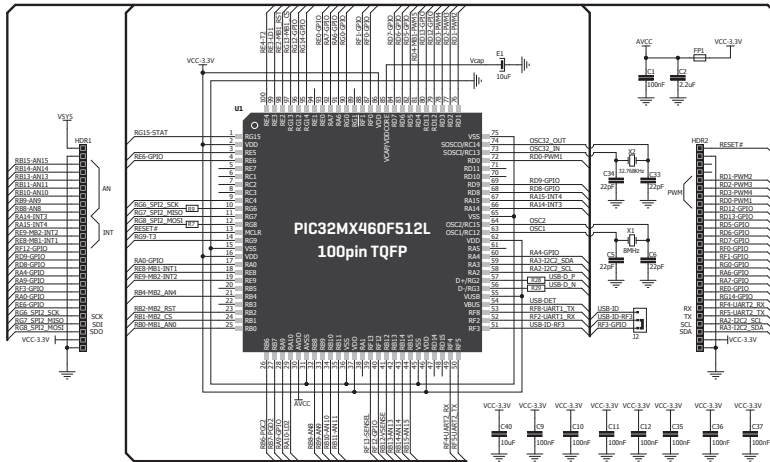

Figure 7-2: USB module connection schematic

8. Pads



Pads HDR2

Figure 8-1: Connecting pads schematic

Pads HDR1

Most microcontroller pins are available for further connectivity via two 1x26 rows of connection pads on both sides of the clicker 2 for PIC32MX board. They are designed to match additional shields, such as Battery Boost shield, Gaming, PROTO shield and others.

9. Pinout

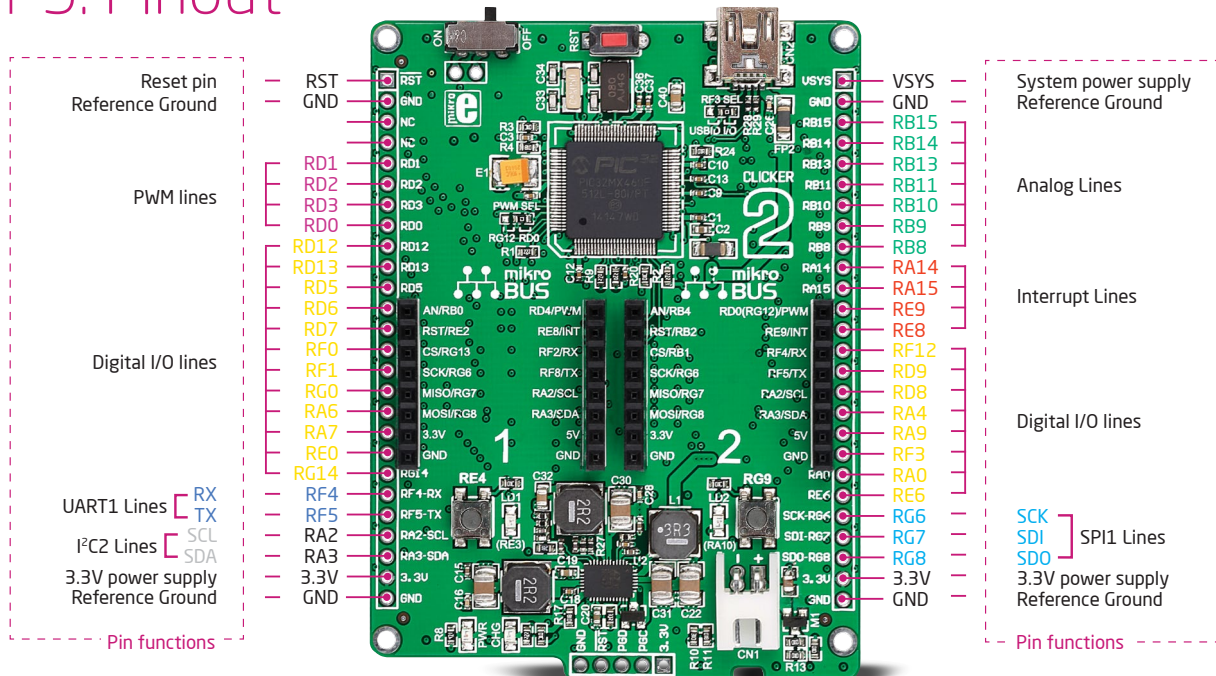

■ Digital lines
 ■ Analog Lines
 ■ Interrupt Lines
 ■ SPI Lines
 ■ I²C Lines
 ■ UART lines
 ■ PWM lines

9.1 PWM jumper selection

Clicker 2 for PIC32MX employs a solution to optimize the use of available pins and MCU I/Os. The **PWM SEL jumper (Figure 9-2)** enables **two modes** of use for the second available PWM line:

- 1 The default position of the jumper is for applications when you're not using the PWM line on the 1x26 pinout on the right side of the board. This keeps this PWM available through mikroBUS™ 2
- 2 If you resolder the jumper into the second position, it would turn the PWM line on mikroBUS™ 2 into a GPIO. You would use this in scenarios where you already utilized the PWM through the 1x26 pinout (which would make the PWM pin on mikroBUS™ 2 unusable)

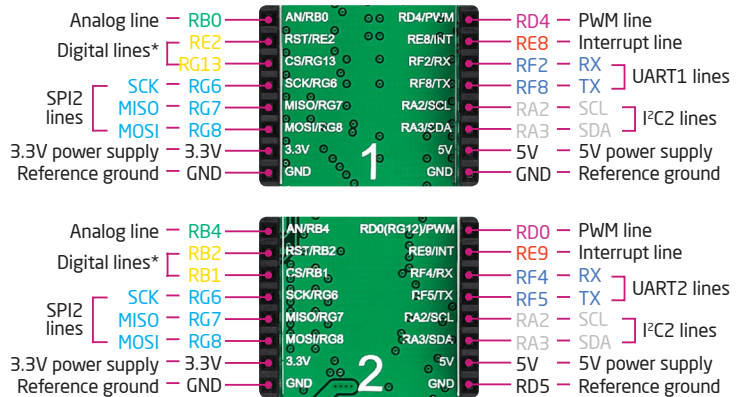

Figure 9-1: mikroBUS™ individual and shared lines

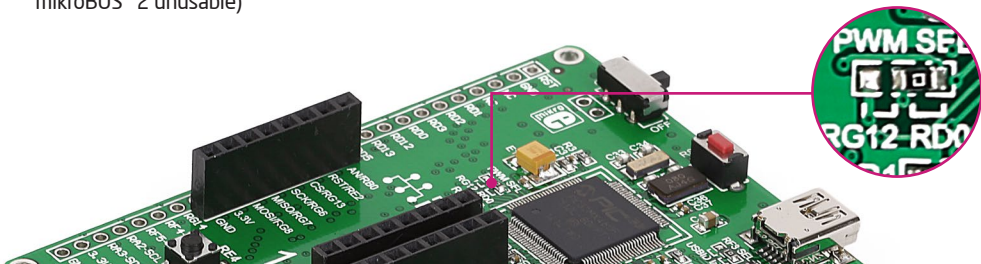
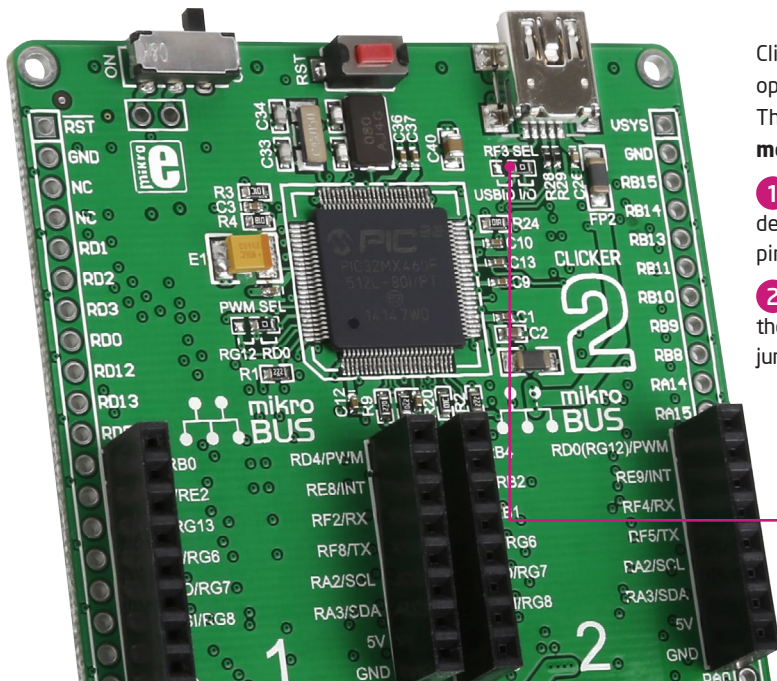

Figure 9-2: PWM SEL jumper

9.2 RF3/USBID Jumper selection



Clicker 2 for PIC32MX employs a solution to optimize the use of available pins and MCU I/Os. The **PWM SEL jumper** (Figure 9-2) enables **two modes** of use for the second available PWM line:

- 1 To use RF3 as a GPIO, keep the jumper in the default position (connected to the corresponding pin on the 1x26 connection pad, see page 26)
- 2 To connect the RF3 MCU pin to USB-ID (one of the four pins on the USB port), resolder the RF3 SEL jumper (zero-ohm resistor) to the other position.



Figure 9-3:
RF3/USBID jumper

10. click™ boards are plug and play!

Up to now, MikroElektronika has released more than a 100 mikroBUS™ compatible **click™ boards**. On the average, one click™ board is released per week. It is our intention to provide you with as many add-on boards as possible, so you will be able to expand your development board with additional functionality. Each board comes with a set of working example code. Please visit the click™ boards webpage for the complete list of currently available boards:

www.mikroe.com/click

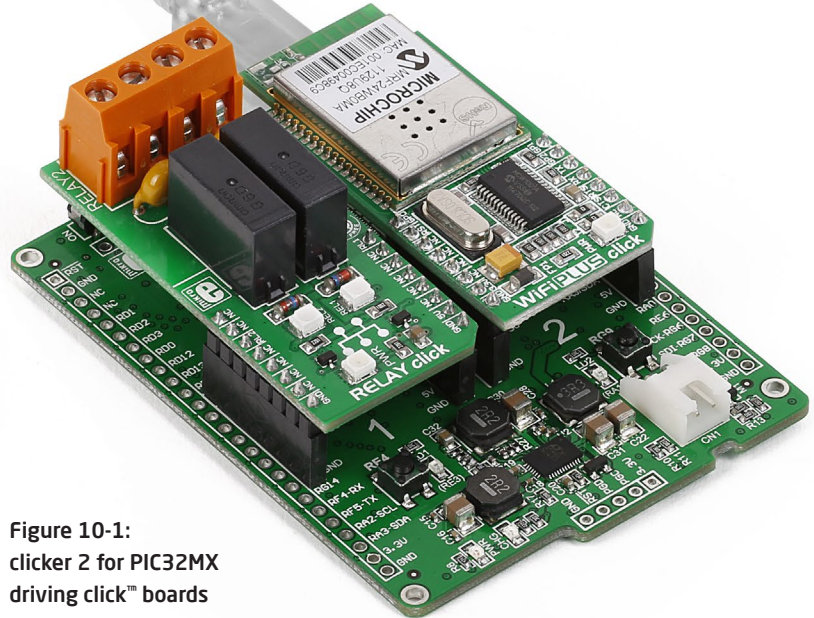
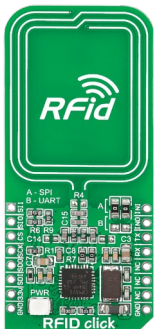
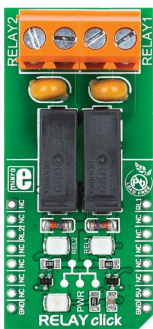

Figure 10-1:
clicker 2 for PIC32MX
driving click™ boards



RFID click™



Relay click™

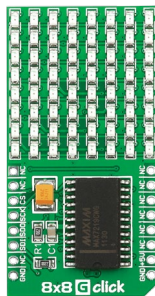

8x8 click™

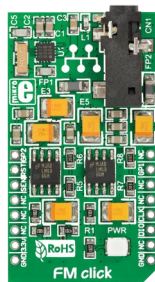

FM click™



Bluetooth2 click™



Thunder click™

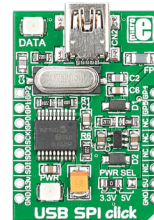

USB SPI click™

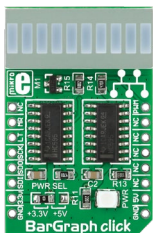

BarGraph click™

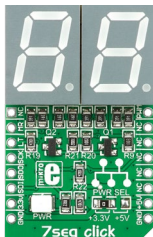

7seg click™



THERMO click™

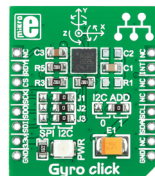

Gyro click™

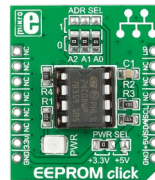

EEPROM click™

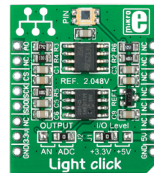

Light click™

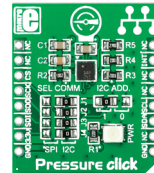

Pressure click™

11. Dimensions

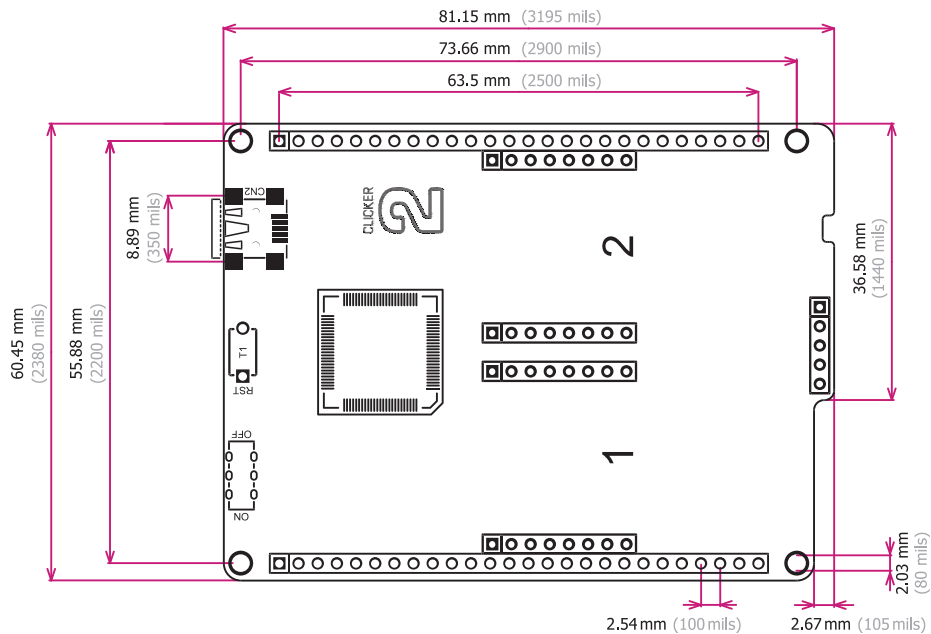

DISCLAIMER

All the products owned by MikroElektronika are protected by copyright law and international copyright treaty. Therefore, this manual is to be treated as any other copyright material. No part of this manual, including product and software described herein, may be reproduced, stored in a retrieval system, translated or transmitted in any form or by any means, without the prior written permission of MikroElektronika. The manual PDF edition can be printed for private or local use, but not for distribution. Any modification of this manual is prohibited.

MikroElektronika provides this manual 'as is' without warranty of any kind, either expressed or implied, including, but not limited to, the implied warranties or conditions of merchantability or fitness for a particular purpose.

MikroElektronika shall assume no responsibility or liability for any errors, omissions and inaccuracies that may appear in this manual. In no event shall MikroElektronika, its directors, officers, employees or distributors be liable for any indirect, specific, incidental or consequential damages (including damages for loss of business profits and business information, business interruption or any other pecuniary loss) arising out of the use of this manual or product, even if MikroElektronika has been advised of the possibility of such damages. MikroElektronika reserves the right to change information contained in this manual at any time without prior notice, if necessary.

HIGH RISK ACTIVITIES

The products of MikroElektronika are not fault - tolerant nor designed, manufactured or intended for use or resale as on - line control equipment in hazardous environments requiring fail - safe performance, such as in the operation of nuclear facilities, aircraft navigation or communication systems, air traffic control, direct life support machines or weapons systems in which the failure of Software could lead directly to death, personal injury or severe physical or environmental damage ('High Risk Activities'). MikroElektronika and its suppliers specifically disclaim any expressed or implied warranty of fitness for High Risk Activities.

TRADEMARKS

The MikroElektronika name and logo, mikroC™, mikroBasic™, mikroPascal™, Visual TFT™, Visual GLCD™, mikroProg™, Ready™, MINI™, mikroBUS™, EasyPIC™, EasyAVR™, Easy8051™, click™ boards and mikromedia™ are trademarks of MikroElektronika. All other trademarks mentioned herein are property of their respective companies. All other product and corporate names appearing in this manual may or may not be registered trademarks or copyrights of their respective companies, and are only used for identification or explanation and to the owners' benefit, with no intent to infringe.

Copyright © 2014 MikroElektronika. All Rights Reserved.



If you want to learn more about our products, please visit our web site at
www.mikroe.com

If you are experiencing some problems with any of our products or just need additional information, please place your ticket at **www.mikroe.com/support**

If you have any questions, comments or business proposals, do not hesitate to contact us at **office@mikroe.com**

Clicker 2 for PIC32MX manual
ver 1.02



0100000070901