

C4AK, Radial, 2 Leads, 700 – 900 VDC, for DC Link (Automotive Grade) - 125°C with Long Life and High Voltage

Overview

The C4AK capacitor is a new polypropylene material metallized film capacitor with a rectangular, plastic box-type design (black color) filled with resin, and uses 2 tinned wires.

Automotive grade devices meet the demanding Automotive Electronics Council's AEC-Q200 qualification requirements with longer life at 125°C (higher voltage derated) and 135°C.

Applications

Typical applications include DC filtering, DC link, power electronics, energy storage, renewable energy grid interface, motor drives, and automotive applications.

Benefits

- High voltage & long life at 125°C
- Voltage derated at 135°C
- THB 85°C/85% R.H. at V_R for 1,000 hours
- Low Halogen Content according to JS709C
- Self-healing
- Low loss
- Low ESL
- Low profile dimensions available under request
- High ripple current
- High dV/dt
- High capacitance density
- High contact reliability
- Suitable for high frequency applications
- Automotive Grades (AEC-Q200)

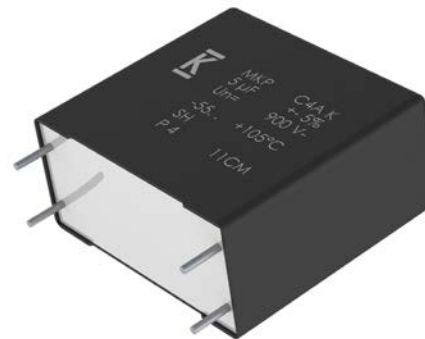

Part Number System

C4	A	K	J	B	W	5125	A	3	2	J
Series	Type	Application	Rated Voltage (VDC)	Case	Terminals Code	Capacitance Code (pF)	Release	Lead Diameter (mm)	Size Code: B x H x L (mm)	Tolerance
C4 = MKP power capacitors	A = Box, wire terminals	K = DC link Automotive Grade with new PP resin material	J = 700 O = 900	B = Box plastic case L = Low Profile box, plastic case	U = 2 pins W = 4 pins	Digits 2 – 4 indicate the first three digits of the capacitance value. First digit indicates the number of zeros to be added.	A = Standard	3 = 1.2	See dimensions table below for valid case sizes	J = 5% K = 10%

Series Selection

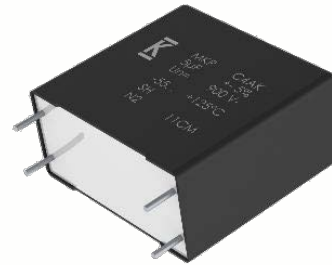

**DC-LINK, DC FILTER
 TREE FAMILY**

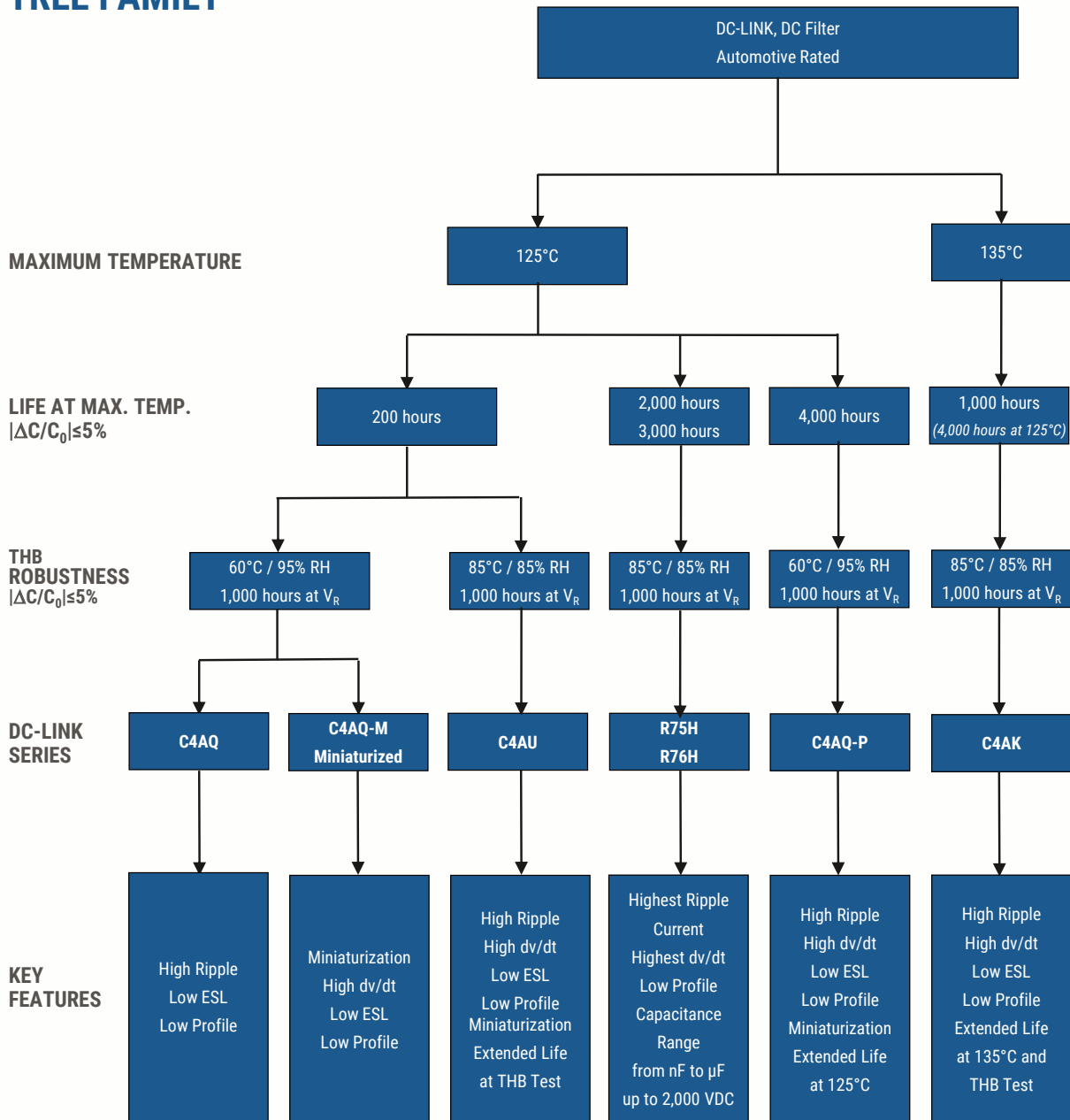

KEY FEATURES

©KEMET Corporation. All Rights Reserved.

Dimensions – Millimeters

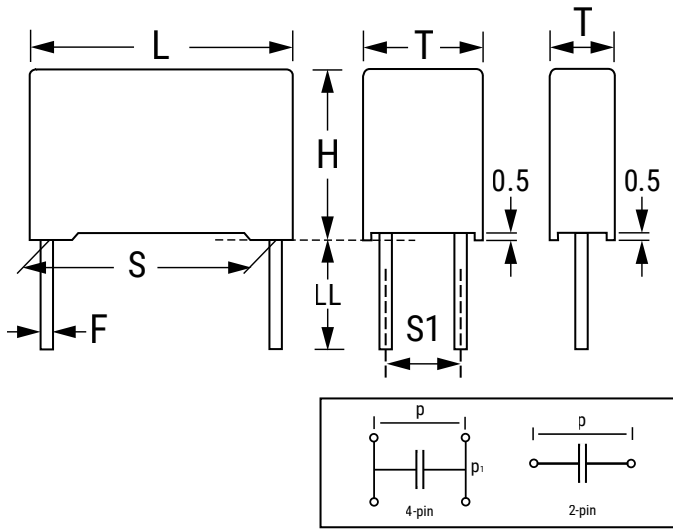

Size Code		S		S1		T		H		L		LL		F	
Digit 6	Digit 14	Nominal	Tolerance	Nominal	Tolerance	Nominal	Tolerance	Nominal	Tolerance	Nominal	Tolerance	Nominal	Tolerance	Nominal	Tolerance
B	W	27.5	±0.4	-	-	11.0	+0.7/-0.7	20.0	+0.7/-0.7	32.0	+0.7/-0.7	6	+0/-2	1.2	±0.05
B	B	27.5	±0.4	-	-	13.0	+0.7/-0.7	22.0	+0.7/-0.7	32.0	+0.7/-0.7	6	+0/-2	1.2	±0.05
B	Y	27.5	±0.4	-	-	14.0	+0.7/-0.7	28.0	+0.7/-0.7	32.0	+0.7/-0.7	6	+0/-2	1.2	±0.05
B	1	27.5	±0.4	-	-	19.0	+0.7/-0.7	29.0	+0.7/-0.7	32.0	+0.7/-0.7	6	+0/-2	1.2	±0.05
B	2	27.5	±0.4	-	-	22.0	+0.7/-0.7	37.0	+0.7/-0.7	32.0	+0.7/-0.7	6	+0/-2	1.2	±0.05
B	F	37.5	±0.4	10.2	±0.4	20.0	+1.0/-1.0	40.0	+1.0/-1.0	42.0	+1.0/-1.0	6	+0/-2	1.2	±0.05
B	J	37.5	±0.4	10.2	±0.4	28.0	+1.0/-1.0	37.0	+1.0/-1.0	42.0	+1.0/-1.0	6	+0/-2	1.2	±0.05
B	H	37.5	±0.4	10.2	±0.4	24.0	+1.0/-1.0	44.0	+1.0/-1.0	42.0	+1.0/-1.0	6	+0/-2	1.2	±0.05
B	L	37.5	±0.4	20.3	±0.4	30.0	+1.0/-1.0	45.0	+1.0/-1.0	42.0	+1.0/-1.0	6	+0/-2	1.2	±0.05
B	P	37.5	±0.4	20.3	±0.4	33.0	+1.0/-1.0	48.0	+1.0/-1.0	42.0	+1.0/-1.0	6	+0/-2	1.2	±0.05
B	M	52.5	±0.4	20.3	±0.4	30.0	+1.2/-1.2	45.0	+1.2/-1.2	57.5	+1.2/-1.2	6	+0/-2	1.2	±0.05
B	N	52.5	±0.4	20.3	±0.4	35.0	+1.2/-1.2	50.0	+1.2/-1.2	57.5	+1.2/-1.2	6	+0/-2	1.2	±0.05
L	1	27.5	±0.4	-	-	21.0	+0.7/-0.7	12.5	+0.7/-0.7	32.0	+0.7/-0.7	6	+0/-2	1.2	±0.05
L	2	27.5	±0.4	-	-	24.0	+0.7/-0.7	15.0	+0.7/-0.7	32.0	+0.7/-0.7	6	+0/-2	1.2	±0.05
L	9	27.5	±0.4	-	-	31.0	+0.7/-0.7	19.0	+0.7/-0.7	32.0	+0.7/-0.7	6	+0/-2	1.2	±0.05
L	3	37.5	±0.4	10.2	±0.4	24.0	+1.0/-1.0	19.0	+1.0/-1.0	42.0	+1.0/-1.0	6	+0/-2	1.2	±0.05
L	4	37.5	±0.4	10.2	±0.4	24.0	+1.0/-1.0	15.0	+1.0/-1.0	42.0	+1.0/-1.0	6	+0/-2	1.2	±0.05
L	6	37.5	±0.4	20.3	±0.4	35.0	+1.0/-1.0	24.0	+1.0/-1.0	42.0	+1.0/-1.0	6	+0/-2	1.2	±0.05
L	8	37.5	±0.4	20.3	±0.4	43.0	+1.0/-1.0	25.0	+1.0/-1.0	42.0	+1.0/-1.0	6	+0/-2	1.2	±0.05

NOTE: Low profile (Digit 6 = "L") available from June 2021

Qualification

Reference Standards	IEC 61071, EN 61071, VDE0560
Climatic Category	55/105/56 according to IEC 60068-1

Automotive grade products meet or exceed the requirements outlined by the Automotive Electronics Council. Details regarding test methods and conditions are referenced in document AEC-Q200, Stress Test Qualification for Passive Components. For additional information regarding the Automotive Electronics Council and AEC-Q200, visit the AEC website at www.aecouncil.com.

General Technical Data

Dielectric	Polypropylene metallized film, non-inductive type, self-healing property
Application	DC filtering, DC link
Special Features	AEC-Q200 qualified
Climatic Category	55/105/56 IEC 60068-1
Temperature Range	-55°C to +135°C
Endurance Test	500 hours at $1.3 \times V_{OP} + C/D$ + 500 hours at $1.3 \times V_{OP}$ at 85°C, 105°C, 125°C, 135°C
Standard	IEC 61071, EN 61071, VDE0560, AEC-Q200
Protection	Solvent resistant plastic case UL 94 V-0 compliant Thermosetting resin sealing UL 94 V-0 compliant
Installation	Any position
Leads	Tinned wires, standard lead wire length 6 (+0/-2) mm
Packaging	Packed in cardboard trays with protection for the terminals
RoHS Compliance	Compliant with Directive 2002/95/EC and Directive 2011/65/EU of the European Parliament and the Council of the EU on 8 June 2011, including the Commission Delegated Directive (EU) 2015/863 that amended Annex II to Directive 2011/65/EU.

Electrical Characteristics

Rated Capacitance Range	1.5 – 60 μ F
Rated Voltage (VNDC) Range	700 – 900 VDC
Capacitance Tolerance	\pm 5% (J) or \pm 10% (K) measured at T = +25°C \pm 5°C
Dissipation Factor PP Typical (tg δ)	\leq 0.0002 at 10 kHz with T = 25°C \pm 5°C
Surge Voltage	1.5 * V _{NDC} for maximum 10 times in a lifetime at 25°C \pm 5°C
Overvoltage (IEC 61071)	1.15 * V _{NDC} for maximum 30 minutes, once per day
	1.3 * V _{NDC} for maximum 1 minute, once per day
Peak Non-Repetitive Current	1.5 * I _{PKR} for maximum 1,000 times in a lifetime
Insulation Resistance	IR x C \geq 30.000 seconds at 100 VDC 1 minute at T = +25°C \pm 5°C
Capacitance Deviation in Operation	\pm 2.0% maximum on capacitance value measured at T = +25°C \pm 5°C
Temperature Storage	-40 to +80°C
Storage time	\leq 36 months from the date marked on the label glued to the package
Permissible Relative Humidity - Storage	Annual average \leq 70%, 85% on 30 days/year randomly distributed throughout year. Dewing not admissible.

Life Expectancy

Life Expectancy	100,000 hours at V _{NDC} at hot spot temperature T _{HS} = +85°C
	20,000 hours at V _{OP105} at hot spot temperature T _{HS} = +105°C
	1,000 hours at V _{OP135} at hot spot temperature T _{HS} = +135°C
Capacitance Drop at End of Life	-5% (typical)
Failure Rate IEC 61709	\leq 200 FIT at V _{OP85} at hot spot temperature T _{HS} = +85°C

Test Method

Test Voltage Between Terminals	$1.5 * V_{NDC}$ for 10 seconds or $1.65 * V_{NDC}$ for 2 seconds, at $T = +25^{\circ}\text{C} \pm 5^{\circ}\text{C}$
Test Voltage Between Terminals and Case	3.2 k VAC 50 Hz for 2 seconds
Damp Heat	IEC 60068-2-78
Change of Temperature	IEC 60068-2-14
Biased Humidity Test 40°C/93% R.H. at V_{NDC} - 1,000 hours	$ \Delta C/C_0 \leq 5\%$ $ \Delta DF/DF_0 \leq 100\%$ (at 10 kHz) $IR \geq 50\%$ of initial limit
Biased Humidity Test 60°C/95% R.H. at V_{NDC} - 1,000 hours	$ \Delta C/C_0 \leq 5\%$ $ \Delta DF/DF_0 \leq 200\%$ (at 10 kHz) $IR \geq 100 \text{ M}\Omega$
Biased Humidity Test 85°C/85% R.H. at V_{NDC} - 1,000 hours	$ \Delta C/C_0 \leq 10\%$ $ \Delta DF \leq 0.005$ (at 1 kHz) $IR \geq 100 \text{ M}\Omega$

Operative Voltage Derating

	Symbol	Voltage (VDC)		Life Expectancy (Hours)
Rated Voltage at 85°C (T_{HS})	V_{NDC}	700	900	100,000
Operating Voltage at 105°C (T_{HS})	V_{OP105}	600	800	20,000
Operating Voltage at 125°C (T_{HS})	V_{OP125}	500	720	4,000
Operating Voltage at 135°C (T_{HS})	V_{OP135}	400	500	1,000

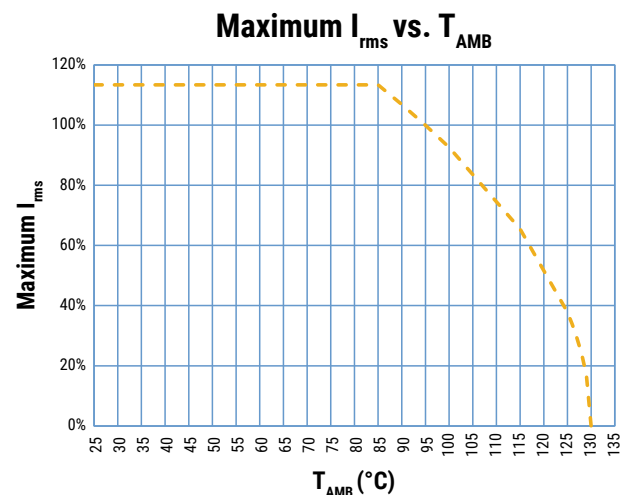
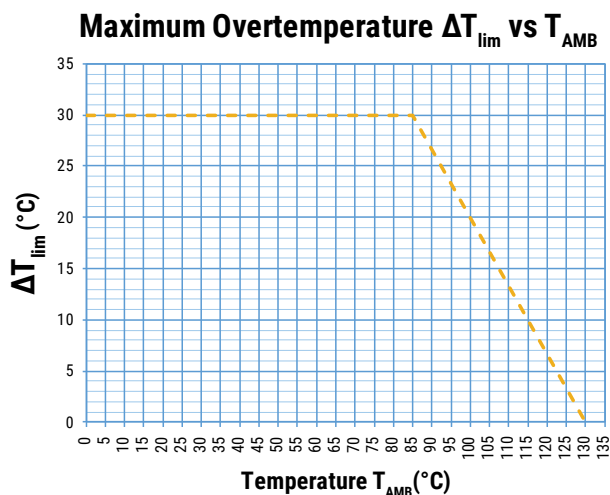

T_{AMB} is the maximum ambient temperature surrounding the capacitor or hottest contact point (e.g. tracks), whichever is higher, in the worst operation conditions in °C.

Typical Waveforms

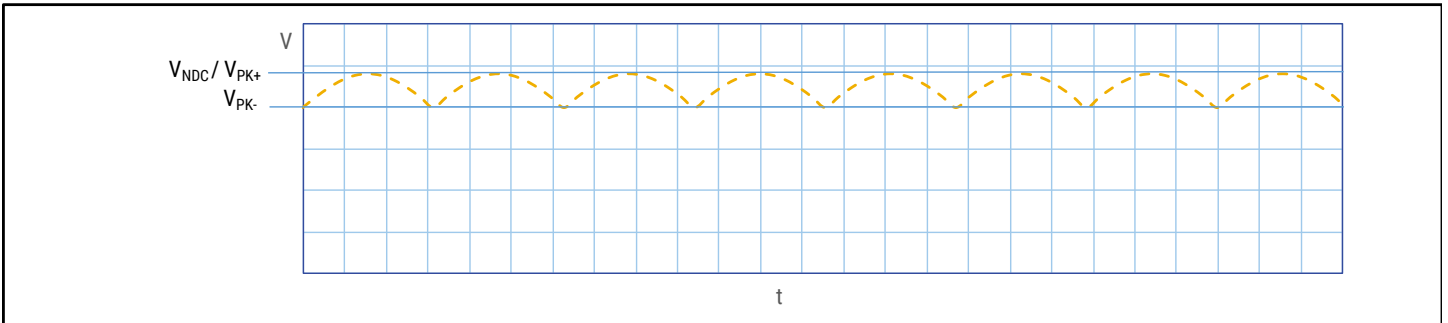
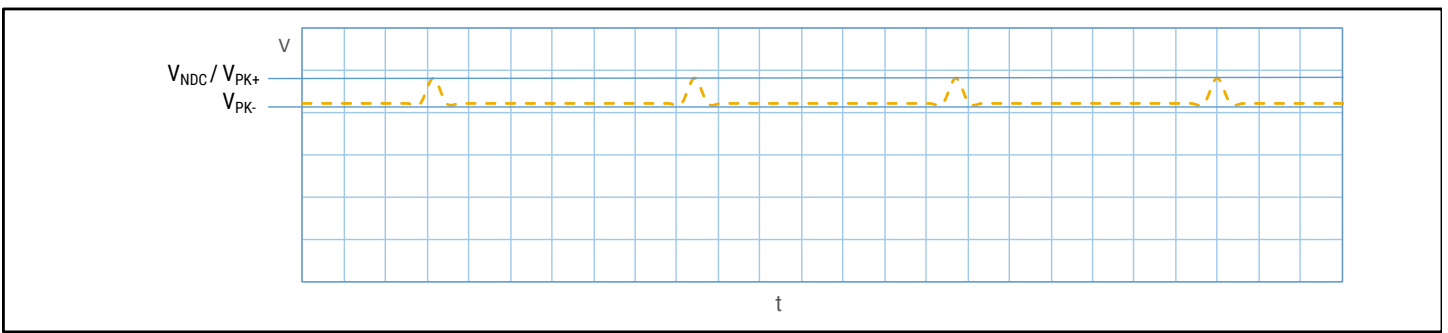
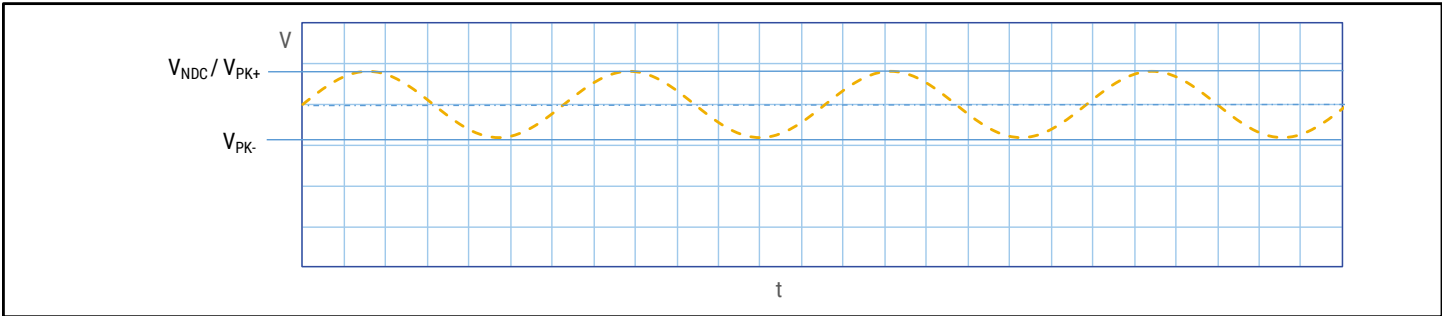

The applied peak-to-peak ripple voltage shall not exceed $0.2 \times V_{NDC}$.
The peak voltage shall not exceed the rated voltage V_{NDC} .

Life Expectancy/Failure Quota Graphs

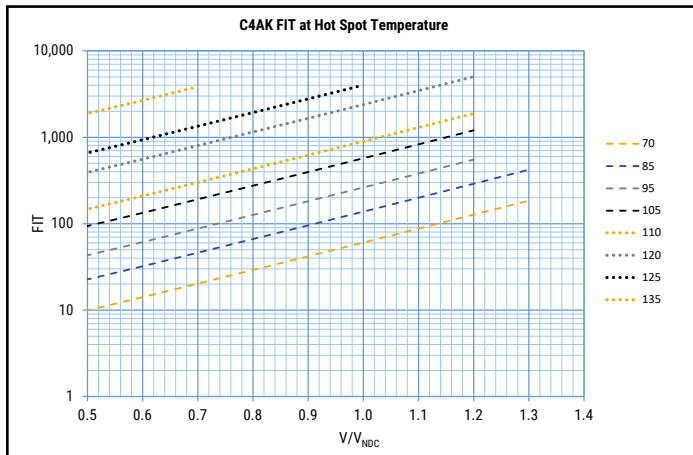
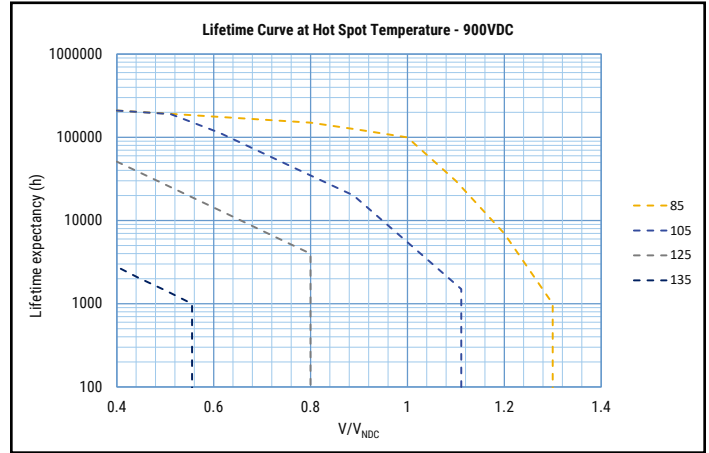
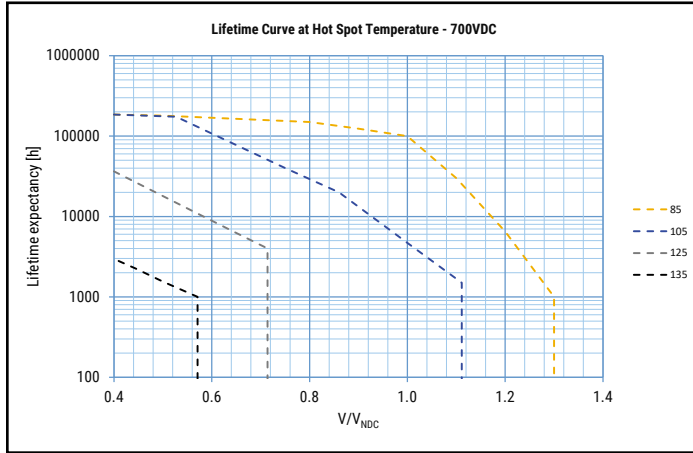

Environmental Compliance

As a leading global supplier of electronic components and an environmentally conscious company, KEMET continually aspires to improve the environmental effects of our manufacturing processes and our finished electronic components.

In Europe (RoHS Directive) and in some other geographical areas such as China (China RoHS), legislation has been enacted to prevent or otherwise limit the use of certain hazardous materials, including lead (Pb), in electronic equipment. KEMET monitors legislation globally to ensure compliance and endeavors to adjust our manufacturing processes and/or electronic components as may be required by applicable law.

Environmental Compliance cont.

For military, medical, automotive, and some commercial applications, the use of lead (Pb) in the termination is necessary and/or required by design. KEMET is committed to communicating RoHS compliance to our customers. Information related to RoHS compliance will be provided in data sheets and using specific identifiers on the packaging labels.

All KEMET power film capacitors are RoHS compliant.



All Part Numbers



Materials & Environment

The selection of raw materials that KEMET uses for the production of its electronic components is the result of extensive experience. KEMET directs specific attention toward environmental protection. KEMET selects its suppliers according to ISO 9001 standards and performs statistical analyses on raw materials before acceptance for use in manufacturing our electronic components. All materials are, to the best of KEMET's knowledge, non-toxic and free from cadmium; mercury; chrome and compounds; polychlorine triphenyl (PCB); bromide and chlorinedioxins bromurate clorurate; CFC and HCFC; and asbestos.

Dissipation Factor

Dissipation factor is a complex function involved with capacitor inefficiency. The $\text{tg}\delta$ may vary up and down with increased temperature. For more information, refer to Performance Characteristics.

Sealing

Hermetically Sealed Capacitors

As the temperature increases, the pressure inside the capacitor increases. If the internal pressure is high enough, it can cause a breach in the capacitor. Such a breach can result in leakage, impregnation, filling fluid, or moisture susceptibility.

Barometric Pressure

The altitude at which hermetically sealed capacitors are operated controls the capacitor's voltage rating. As the barometric pressure decreases, the susceptibility to terminal arc-over increases. Non-hermetic capacitors can be affected by internal stresses due to pressure changes. These effects can be in the form of capacitance changes, dielectric arc-over, and/or low insulation resistance. Altitude can also affect heat transfer. Heat that is generated in an operation cannot be dissipated properly, and high RI^2 losses and eventual failure can result.

Table 1 – Ratings & Part Number Reference

Cap Value (µF)	VDC	Dimensions (mm)					dV/dt V/µs	lpkr Apk	ESL nH	ESR _{typ} at 10 kHz mΩ	I _{rms} * 95°C at 10 kHz Arms	R _{th} (HS/Amb) (°C/W)	Packaging Quantity	PART NUMBER
		T	H	L	S	S1								
V_{NDC} at 85°C = 700 VDC; V_{OP105} at 105°C = 600 VDC; V_{OP125} at 125°C = 500 VDC														
1.8	700	11	20	32	27.5	\	40	72	17	28.5	4.2	44	256	C4AKJBU4180A3WJ
2.7	700	13	22	32	27.5	\	40	108	22	19.5	5.6	39	234	C4AKJBU4270A3BJ
4	700	14	28	32	27.5	\	40	160	24	13.4	7.1	33	96	C4AKJBU4400A3VJ
8	700	19	29	32	27.5	\	40	320	25	8.0	9.7	29	72	C4AKJBU4800A31J
12	700	22	37	32	27.5	\	40	480	28	6.1	12.5	23	64	C4AKJBU5120A32J
15	700	20	40	42	37.5	10.2	20	300	12	6.8	12.7	20	58	C4AKJBW5150A3FJ
20	700	28	37	42	37.5	10.2	20	400	10	5.2	15.4	18	36	C4AKJBW5200A3JJ
22	700	24	44	42	37.5	10.2	20	440	12	4.7	16.6	17	44	C4AKJBW5220A3HJ
30	700	30	45	42	37.5	20.3	20	600	13	3.2	21.5	15	36	C4AKJBW5300A3LJ
35	700	33	48	42	37.5	20.3	20	700	14	3.0	23.0	14	30	C4AKJBW5350A3PJ
45	700	30	45	57.5	52.5	20.3	10	450	13	4.8	19.5	12	27	C4AKJBW5450A3MJ
60	700	35	50	57.5	52.5	20.3	10	600	15	3.7	24.5	10	23	C4AKJBW5600A3NJ
V_{NDC} at 85°C = 900 VDC; V_{OP105} at 105°C = 800 VDC; V_{OP125} at 125°C = 720 VDC														
1.2	900	11	20	32	27.5	\	40	48	17	35.0	3.8	44	256	C4AKOBU4120A3WJ
1.5	900	13	22	32	27.5	\	40	60	22	28.0	4.7	39	234	C4AKOBU4150A3BJ
2.7	900	14	28	32	27.5	\	40	108	24	16.0	6.5	33	96	C4AKOBU4270A3VJ
5	900	19	29	32	27.5	\	40	200	25	10.0	8.7	29	72	C4AKOBU4500A31J
8	900	22	37	32	27.5	\	40	320	28	7.3	11.5	23	64	C4AKOBU4800A32J
10	900	20	40	42	37.5	10.2	20	200	12	8.2	11.7	20	58	C4AKOBW5100A3FJ
14	900	28	37	42	37.5	10.2	20	280	10	5.9	14.4	18	36	C4AKOBW5140A3JJ
15	900	24	44	42	37.5	10.2	20	300	12	5.6	15.3	17	44	C4AKOBW5150A3HJ
20	900	30	45	42	37.5	20.3	20	400	13	4.3	18.5	15	36	C4AKOBW5200A3LJ
24	900	33	48	42	37.5	20.3	20	480	14	3.5	21.5	14	30	C4AKOBW5240A3PK
30	900	30	45	57.5	52.5	20.3	10	300	13	5.7	18.0	12	27	C4AKOBW5300A3MJ
40	900	35	50	57.5	52.5	20.3	10	400	15	4.4	22.5	10	23	C4AKOBW5400A3NK
Cap Value (µF)	VDC	T	H	L	S	S1	V/µs	Apk	nH	mΩ	Arms	(°C/W)	Packaging Quantity	PART NUMBER
Dimensions (mm)						dV/dt	lpkr	ESL	ESR _{typ} at 10 kHz	I _{rms} * 95°C at 10 kHz	R _{th} (HS/Amb)			

(*) I_{rms} value that leads to a ΔT of ≈ 30°C in the hot spot » T_{HS} = T_{AMB} + ΔT = 95°C + 30°C = 125°C. Attention: Hot spot at 125°C reduced the life time!

Table 2 – Ratings & Part Number Reference for Low Profile Design

Cap Value (µF)	VDC	Dimensions (mm)					dV/dt V/µs	Ipkr Apk	ESL nH	ESR _{typ} at 10 kHz mΩ	I _{rms} * 95°C at 10 kHz Arms	R _{th} (HS/Amb) (°C/W)	Packaging Quantity	PART NUMBER
		T	H	L	S	S1								
V_{NDC} at 85°C = 700 VDC; V_{OP105} at 105°C = 600 VDC; V_{OP125} at 125°C = 500 VDC														
2.7	700	21	12.5	32	27.5	\	40	108	11	19.8	4.9	46	192	C4AKJLU4270A31J
3.8	700	24	15	32	27.5	\	40	152	13	14.5	6.2	39	168	C4AKJLU4380A32J
7.5	700	31	19	32	27.5	\	40	300	16	8.0	9.5	30	80	C4AKJLU4750A39J
5.8	700	24	15	42	37.5	10.2	20	116	7	17.3	6.2	33	132	C4AKJLW4580A34J
8	700	24	19	42	37.5	10.2	20	160	8	12.5	7.8	29	88	C4AKJLW4800A33J
15	700	35	24	42	37.5	20.3	20	300	9	6.8	11.8	23	60	C4AKJLW5150A36J
22	700	43	25	42	37.5	20.3	20	440	9	4.7	15.7	19	48	C4AKJLW5220A38J
V_{NDC} at 85°C = 900 VDC; V_{OP105} at 105°C = 800 VDC; V_{OP125} at 125°C = 720 VDC														
1.5	900	21	12.5	32	27.5	\	40	60	11	28.6	4.1	46	192	C4AKOLU4150A31J
2.5	900	24	15	32	27.5	\	40	100	13	17.7	5.6	39	168	C4AKOLU4250A32J
4.8	900	31	19	32	27.5	\	40	192	16	9.9	8.6	30	80	C4AKOLU4480A39J
3.8	900	24	15	42	37.5	10.2	20	76	7	21.2	5.6	33	132	C4AKOLW4380A34J
5	900	24	19	42	37.5	10.2	20	100	8	16.2	6.8	29	88	C4AKOLW4500A33J
10	900	35	24	42	37.5	20.3	20	200	9	8.1	10.8	23	60	C4AKOLW5100A36J
14	900	43	25	42	37.5	20.3	20	280	9	5.9	14	19	48	C4AKOLW5140A38J
Cap Value (µF)	VDC	T	H	L	S	S1	V/µs	Apk	nH	mΩ	Arms	(°C/W)	Packaging Quantity	PART NUMBER
		Dimensions (mm)					dV/dt	Ipkr	ESL	ESR _{typ} at 10 kHz	I _{rms} * 95°C at 10 kHz	R _{th} (HS/Amb)		

Available from Q4 2021

(*) I_{rms} value that leads to a ΔT of ≈ 30°C in the hot spot » T_{HS} = T_{AMB} + ΔT = 95°C + 30°C = 125°C. Attention: Hot spot at 125°C reduced the life time!

Soldering Process

The implementation of the RoHS directive has resulted in the selection of SnAuCu (SAC) alloys, or SnCu alloys, as the primary solder material. This has increased the liquidus temperature from 183°C for a SnPb eutectic alloy to 217 – 221°C for new alloys. As a result, the heat stress to the components, even in wave soldering, has increased considerably due to higher pre-heat and wave temperatures. Polypropylene capacitors are especially sensitive to heat (the melting point of polypropylene is 160 – 170°C). Wave soldering can be destructive, especially for mechanically small polypropylene capacitors (with lead spacing of 5 – 15 mm), and great care must be taken during soldering. The recommended solder profiles from KEMET should be used. Contact KEMET with any questions. In general, the wave soldering curve from IEC Publication 61760-1 Edition 2 serves as a solid guideline for successful soldering. See Figure 1.

Reflow soldering is not recommended for through-hole film capacitors. Exposing capacitors to a soldering profile in excess of the recommended limits may result in degradation or permanent damage to the capacitors.

Do not place the polypropylene capacitor through an adhesive curing oven to cure resin for surface mount components. Insert through-hole parts after curing the surface mount parts. Contact KEMET to discuss the actual temperature profile in the oven, if through-hole components must pass through the adhesive curing process. A maximum two soldering cycles is recommended. Allow time for the capacitor surface temperature to return to normal before the second soldering cycle.

Manual Soldering Recommendations

Following is the recommendation for manual soldering with a soldering iron.



The soldering iron tip temperature should be set at 350°C (+10°C maximum) with the soldering duration not to exceed more than 3 seconds.

Wave Soldering Recommendations

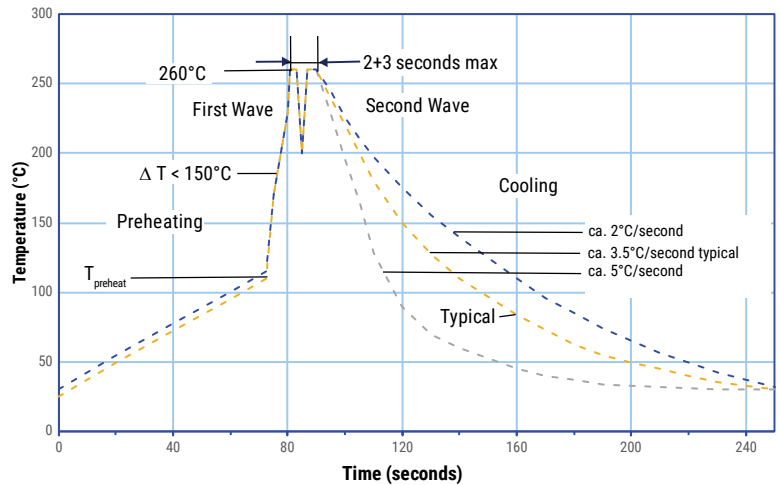

Soldering Process cont.

Wave Soldering Recommendations cont.

1. The tables indicates the maximum set-up temperature of the soldering process

Dielectric Film Material	Maximum Preheat Temperature		Maximum Peak Soldering Temperature	
	Capacitor Pitch ≤ 15 mm	Capacitor Pitch > 15 mm	Capacitor Pitch ≤ 15 mm	Capacitor Pitch > 15 mm
Polyester	130°C	130°C	270°C	270°C
Polypropylene	110°C	130°C	260°C	270°C
Paper	130°C	140°C	270°C	270°C
Polyphenylene Sulphide	150°C	160°C	270°C	270°C

2. The maximum temperature measured inside the capacitor: set the temperature so that inside the element the maximum temperature is below the limit.

Dielectric Film Material	Maximum Temperature Measured Inside the Element
Polyester	160°C
Polypropylene	110°C
Paper	160°C
Polyphenylene Sulphide	160°C

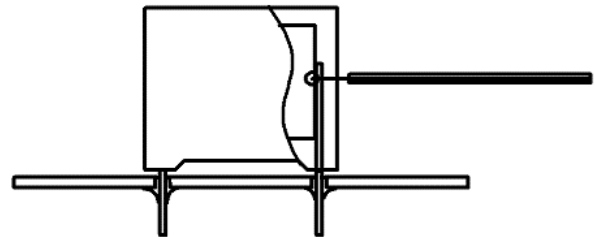

Temperature monitored inside the capacitor.

Selective Soldering Recommendations

Selective dip soldering is a variation of reflow soldering. In this method, the printed circuit board with through-hole components to be soldered is pre-heated and transported over the solder bath, as in normal flow soldering, without touching the solder. When the board is over the bath, it is stopped. Pre-designed solder pots are lifted from the bath with molten solder, only at the places of the selected components, and pressed against the lower surface of the board to solder the components.

The temperature profile for selective soldering is similar to the double wave flow soldering outlined in this document. However, instead of two baths, there is only one with a time from 3 – 10 seconds. In selective soldering, the risk of overheating is greater than in double wave flow soldering, and great care must be taken so that the parts do not overheat.

Mounting

Resistance to Vibration and Mechanical Shock

AEC-Q200 Mechanical Stress Tests:

Mechanical Shock	MIL-SDT-202 Method 213	Test condition C Peak value 100 g, duration 6 ms, half-sine-wave (see MIL-HDBK for details)
Vibration	MIL-SDT-202 Method 204	5 g for 20 minutes, 12 cycles each of 3 orientations Use 8"X5" PCB, .031" thick. 7 secure points on one 8" side and 2 secure points at corners of opposite sides. Parts mounted within 2" from any secure point. Test from 10 – 2,000 Hz.

The capacitors are designed for PCB mounting.
 The stand-off pipes must be in good contact with the printed circuit board.
 The capacitor body has to be properly fixed (e.g. clamped or glued).

Construction

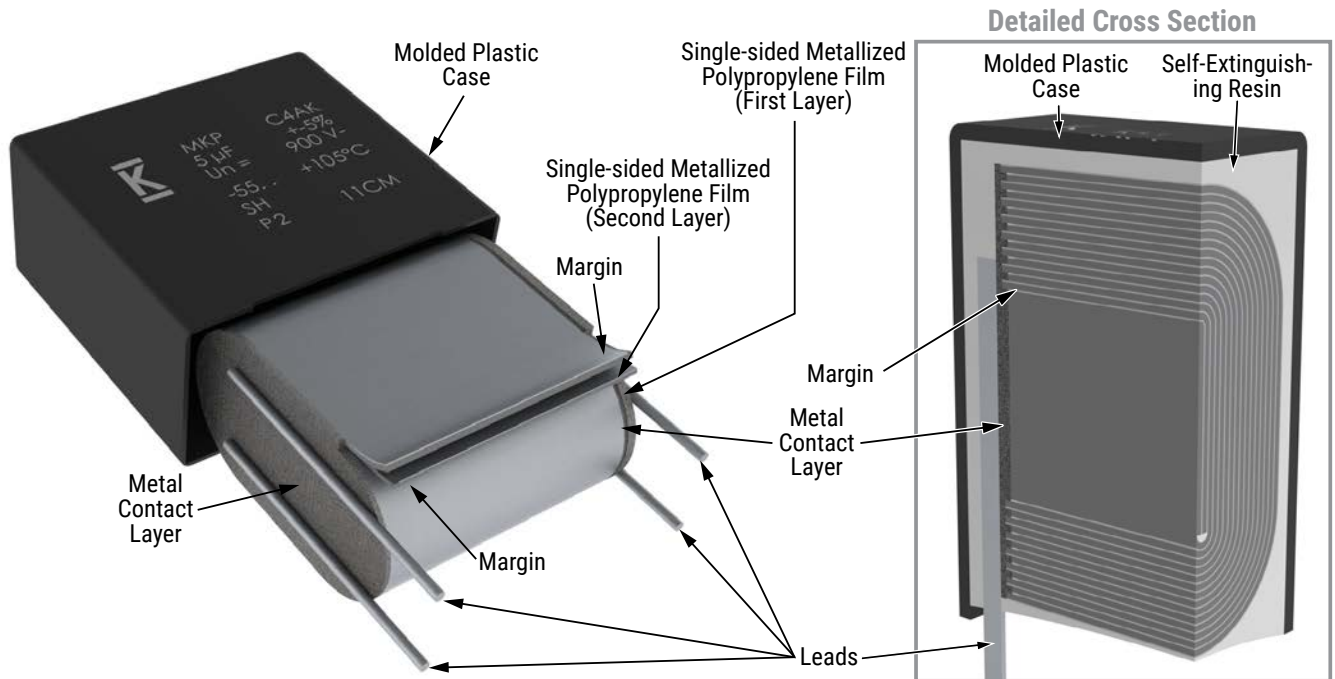

Construction cont.

Low Profile Version:

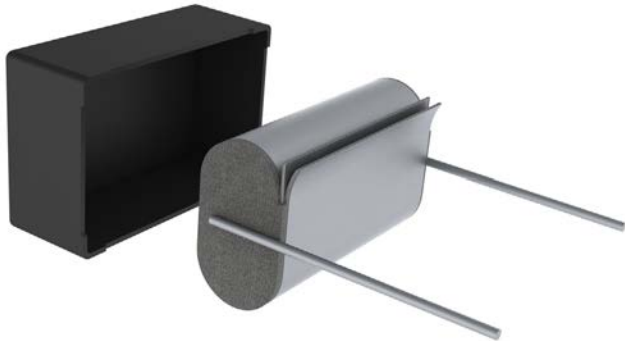

Winding Scheme:

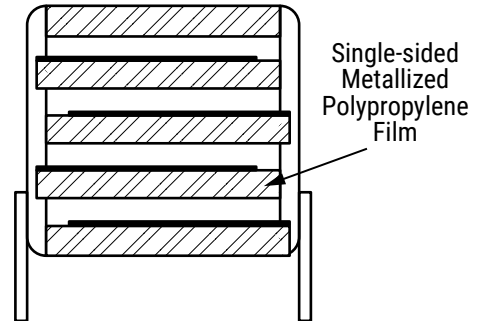

Marking

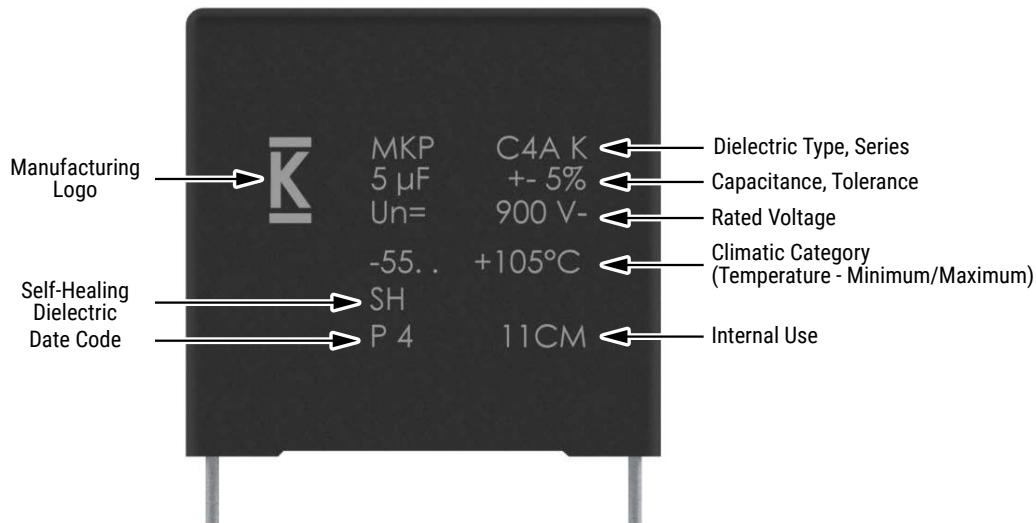

Manufacturing Date Code (IEC-60062)

Year	Code	Year	Code	Year	Code	Month	Code	Month	Code
2010	A	2017	J	2024	S	January	1	July	7
2011	B	2018	K	2025	T	February	2	August	8
2012	C	2019	L	2026	U	March	3	September	9
2013	D	2020	M	2027	V	April	4	October	0
2014	E	2021	N	2028	W	May	5	November	N
2015	F	2022	P	2029	X	June	6	December	D
2016	H	2023	R	2030	A				

KEMET Electronics Corporation Sales Offices

For a complete list of our global sales offices, please visit www.kemet.com/sales.

Disclaimer

All product specifications, statements, information and data (collectively, the "Information") in this datasheet are subject to change. The customer is responsible for checking and verifying the extent to which the Information contained in this publication is applicable to an order at the time the order is placed. All Information given herein is believed to be accurate and reliable, but it is presented without guarantee, warranty, or responsibility of any kind, expressed or implied.

Statements of suitability for certain applications are based on KEMET Electronics Corporation's ("KEMET") knowledge of typical operating conditions for such applications, but are not intended to constitute – and KEMET specifically disclaims – any warranty concerning suitability for a specific customer application or use. The Information is intended for use only by customers who have the requisite experience and capability to determine the correct products for their application. Any technical advice inferred from this Information or otherwise provided by KEMET with reference to the use of KEMET's products is given gratis, and KEMET assumes no obligation or liability for the advice given or results obtained.

Although KEMET designs and manufactures its products to the most stringent quality and safety standards, given the current state of the art, isolated component failures may still occur. Accordingly, customer applications which require a high degree of reliability or safety should employ suitable designs or other safeguards (such as installation of protective circuitry or redundancies) in order to ensure that the failure of an electrical component does not result in a risk of personal injury or property damage.

Although all product-related warnings, cautions and notes must be observed, the customer should not assume that all safety measures are indicated or that other measures may not be required.

KEMET is a registered trademark of KEMET Electronics Corporation.