

## ◆ Features

- Cylindrical shape structure, ultra-low internal resistance;
- Comply with ROHS standards no Cd Pb and other pollutants;
- Long charge-discharge cycle life;
- Suitable for high power discharge;
- High voltage up to 2.8V, under the same conditions with high reliability.

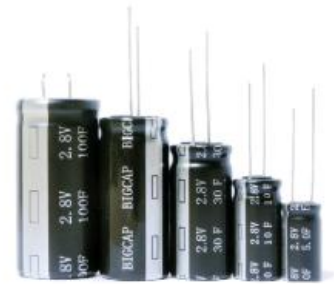

## ◆ Applications

- Working current greater than 100mA, working hours microseconds to a few minutes;
- Can be used for starting device, detonator, the tax control machine, toys, electrical power equipment, etc.

## ◆ Standard test conditions

Products are tested under normal pressure, the temperature range is from 5-35 °C and relative humidity is less than RH85%. The standard test conditions in this product specification are as follows: under normal pressure; the temperature at 25°C and the relative humidity less than 60%

## ◆ Part Number System

Series	Rated Voltage	Structure Type	Capacitance	Internal Control Code
Winding PC Series_BRE	2.7V-002R7	Winding Lead Type_L	0.047F-473	
Winding AN Series_BRP	2.8V-002R8	Winding Snip-in Type_S/C	0.1F-104	
Coin PC Series_BCE	5.4V-005R4	Winding Whorl Type_W	0.47F-474	
Coin 4Φ Series_BCM	5.5V-005R5	Winding Bolt Type_B	1.0F-105	
Coin 85°C Series_BCT	48-048R0	Winding Multi Lead Type_M	2.0F-205	
Module 85°C Series_BMT	100-100R0	Coin Vertical Type_V	8.0F-805	
Module PC Series_BME	200-200R0	Coin Horizontal Type_H	10F-106	
Module AN Series_BMP			22F-226	
Winding High Energy Series_BUE			100F-107	
Winding High Energy Series_BUP			120F-127	
Winding 85°C Series_BRT			360F-367	
			400F-407	

## ◆ Shape of standard product

Shape of wire lead supercapacitor:

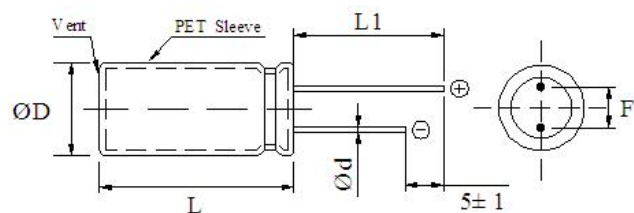

ΦD	5	6.3	8	10	12.5	16	18
Φd	0.5		0.6			0.8	
F	2	2.5	3.5	5		7.5	8
L1	28		30		28/30	30	

Note: unit mm Shows: ΦD×L=12.5×21,L1=28mm

## ◆ BIGCAP®Standard product specification

sheet1

Part Number	Nominal Voltage ,V dc	Capacitance F	Cap.olerance	ESR, mΩ		Size, mm ΦD×L	Weight g	Volume ml
				AC@1kHz	DC			
BRP002R8L104FA	2.8	0.1	0-+40%	450	675	5×12	0.40	0.24
BRP002R8L104FB	2.8	0.1	0-+40%	450	675	5×9.8	0.40	0.19
BRP002R8L154FA	2.8	0.15	±20%	400	600	5×12	0.40	0.24
BRP002R8L154FB	2.8	0.15	±20%	450	675	5×9.8	0.40	0.19
BRP002R8L224FA	2.8	0.22	±20%	500	750	5×12	0.40	0.24
BRP002R8L224FB	2.8	0.22	±20%	500	750	5×9.8	0.50	0.19
BRP002R8L254FA	2.8	0.25	±20%	500	750	5×12	0.50	0.24
BRP002R8L254FB	2.8	0.25	±20%	500	750	6.3×12	0.50	0.37
BRP002R8L354FA	2.8	0.35	±20%	400	600	5×12	0.60	0.24
BRP002R8L504FA	2.8	0.5	0-+40%	500	750	6.3×12	0.65	0.37
BRP002R8L504FB	2.8	0.5	±20%	500	750	5×12	0.65	0.24
BRP002R8L504FC	2.8	0.5	±20%	500	750	6.3×9.8	0.55	0.31
BRP002R8L704FA	2.8	0.7	0-+40%	400	600	8×13	0.85	0.65
BRP002R8L105FA	2.8	1.0	0-+40%	300	450	8×13	0.95	0.65
BRP002R8L105FB	2.8	1.0	0-+40%	200	300	8×19	1.25	0.95
BRP002R8L105FC	2.8	1.0	0-+80%	200	300	8×13	1.05	0.65
BRP002R8L105FD	2.8	1.0	±20%	300	450	6.3×12	0.70	0.37
BRP002R8L105FE	2.8	1.0	0-+40%	100	150	8×15	1.10	0.75
BRP002R8L105FG	2.8	1.0	0-+80%	80	120	10×20	1.50	1.57
BRP002R8L105FH	2.8	1.0	0-+40%	200	300	8×10	0.85	0.50
BRP002R8L205FA	2.8	2.0	±20%	140	210	8×19	1.45	0.95
BRP002R8L205FB	2.8	2.0	±20%	140	210	10×20	1.65	1.57
BRP002R8L305FA	2.8	3.0	0-+40%	100	150	8×19	1.40	0.95
BRP002R8L305FB	2.8	3.0	±20%	120	180	8×16	1.30	0.80
BRP002R8L335FA	2.8	3.3	±20%	80	120	10×20	1.90	1.57
BRP002R8L335FB	2.8	3.3	±20%	100	150	10×16	1.65	1.26
BRP002R8L405FA	2.8	4.0	±20%	80	120	10×20	2.10	1.57
BRP002R8L475FA	2.8	4.7	±20%	70	105	12.5×21	3.10	2.58
BRP002R8L475FB	2.8	4.7	±20%	70	105	10×20	3.10	1.57
BRP002R8L475FC	2.8	4.7	±20%	70	105	12.5×21	3.20	2.58
BRP002R8L505FA	2.8	5.0	0-+40%	70	105	10×20	2.20	1.57

Part Number	Nominal Voltage, V dc	Capacitance F	Cap.olerance	ESR, mΩ		Size, mm ΦD×L	Weight g	Volume ml
				AC@1kHz	DC			
BRP002R8L505FB	2.8	5.0	±20%	70	105	16×26	3.50	5.23
BRP002R8L605FA	2.8	6.0	±20%	70	105	10×20	2.40	1.57
BRP002R8L705FA	2.8	7.0	±20%	70	105	10×25	2.70	1.96
BRP002R8L805FA	2.8	8.0	±20%	50	75	12.5×21	3.50	2.58
BRP002R8L805FC	2.8	8.0	±20%	50	75	12.5×20	3.40	2.45
BRP002R8L106FA	2.8	10	±20%	50	75	12.5×26	3.90	3.19
BRP002R8L106FB	2.8	10	±20%	50	75	12.5×34	4.60	4.17
BRP002R8L106FC	2.8	10	±20%	60	90	12.5×21	3.30	2.58
BRP002R8L106FD	2.8	10	±20%	50	75	10×30	3.20	2.36
BRP002R8L126FB	2.8	12	0-+40%	50	75	12.5×26	3.95	3.19
BRP002R8L156FA	2.8	15	±20%	30	45	16×26	6.00	5.23
BRP002R8L156FB	2.8	15	±20%	30	45	18×41	7.00	10.43
BRP002R8L166FA	2.8	16	±20%	30	45	16×21	5.70	4.22
BRP002R8L206FA	2.8	20	±20%	25	37.5	16×34	7.30	6.83
BRP002R8L226FA	2.8	22	±20%	25	37.5	16×26	7.00	5.23
BRP002R8L256FA	2.8	25	±20%	25	37.5	16×34	8.00	6.83
BRP002R8L306FA	2.8	30	±20%	25	37.5	16×34	8.70	6.83
BRP002R8L306FB	2.8	30	±20%	25	37.5	18×25	9.00	6.36
BRP002R8L406FA	2.8	40	±20%	20	30	18×41	13.50	10.43
BRP002R8L506FA	2.8	50	±20%	20	30	18×41	13.20	10.43
BRP002R8L606FA	2.8	60	±20%	15	22.5	18×41	14.10	10.43
BRP002R8L706FA	2.8	70	±20%	15	22.5	18×52	17.20	13.22

sheet2

Part Number	Max. Stored Energy, mWh	Energy Density		Power Density		Nominal Current,A	Max Current,A	72hLC Leakage Current at 72h (25°C) ,uA
		Wh/kg Gravimetric	Wh/L Volumetric	KW/kg Gravimetric	KW/L Volumetric			
BRP002R8L104FA	0.11	0.27	0.46	7.26	12.33	0.06	0.32	<1
BRP002R8L104FB	0.11	0.27	0.57	7.26	15.10	0.06	0.32	<1
BRP002R8L154FA	0.16	0.41	0.69	8.17	13.87	0.08	0.39	<1
BRP002R8L154FB	0.16	0.41	0.85	7.26	15.10	0.08	0.39	<1
BRP002R8L224FA	0.24	0.60	1.02	6.53	11.10	0.1	0.5	<1
BRP002R8L224FB	0.24	0.48	1.25	5.23	13.59	0.1	0.5	<1
BRP002R8L254FA	0.27	0.54	1.16	5.23	11.10	0.1	0.5	<1
BRP002R8L254FB	0.27	0.54	0.73	5.23	6.98	0.1	0.5	<1
BRP002R8L354FA	0.38	0.64	1.62	5.44	13.87	0.15	0.6	<1
BRP002R8L504FA	0.54	0.84	1.45	4.02	6.98	0.17	0.68	<2
BRP002R8L504FB	0.54	0.84	2.31	4.02	11.10	0.17	0.68	<2
BRP002R8L504FC	0.54	0.99	1.78	4.75	8.55	0.17	0.68	<2
BRP002R8L704FA	0.76	0.90	1.17	3.84	5.00	0.18	0.72	<2
BRP002R8L105FA	1.09	1.15	1.67	4.58	6.67	0.3	0.92	<2
BRP002R8L105FB	1.09	0.87	1.14	5.23	6.84	0.3	0.92	<2

Part Number	Max. Stored Energy, mWh	Energy Density		Power Density		Nominal Current,A	Max Current,A	72hLC Leakage Current at 72h (25°C) ,uA
		Wh/kg Gravimetric	Wh/L Volumetric	KW/kg Gravimetric	KW/L Volumetric			
BRP002R8L105FC	1.09	1.04	1.67	6.22	10.00	0.45	1.41	<2
BRP002R8L105FD	1.09	1.56	2.91	6.22	11.63	0.26	0.81	<2
BRP002R8L105FE	1.09	0.99	1.44	11.88	17.34	0.3	0.92	<2
BRP002R8L105FG	1.09	0.73	0.69	10.89	10.40	0.45	1.41	<2
BRP002R8L105FH	1.09	1.28	2.17	7.69	13.00	0.3	0.92	<2
BRP002R8L205FA	2.18	1.50	2.28	6.44	9.78	0.58	2.0	<4
BRP002R8L205FB	2.18	1.32	1.39	5.66	5.94	0.58	2.0	<4
BRP002R8L305FA	3.27	2.33	3.42	9.33	13.69	0.77	3.19	<6
BRP002R8L305FB	3.27	2.51	4.06	8.38	13.55	0.77	3.19	<6
BRP002R8L335FA	3.59	1.89	2.29	8.60	10.40	0.77	3.19	<7
BRP002R8L335FB	3.59	2.18	2.86	7.92	10.40	0.77	3.19	<7
BRP002R8L405FA	4.36	2.07	2.77	7.78	10.40	0.87	4.19	<8
BRP002R8L475FA	5.12	1.65	1.99	6.02	7.25	1.26	5.0	<10
BRP002R8L475FB	5.12	1.65	3.26	6.02	11.89	1.26	5.0	<10
BRP002R8L475FC	5.12	1.60	1.99	5.83	7.25	1.26	5.0	<10
BRP002R8L505FA	5.44	2.47	3.47	8.48	11.89	1.26	5.0	<10
BRP002R8L505FB	5.44	1.56	1.04	5.33	3.57	1.26	5.0	<10
BRP002R8L605FA	6.53	2.72	4.16	7.78	11.89	1.52	5.5	<12
BRP002R8L705FA	7.62	2.82	3.88	6.91	9.51	2.06	6.0	<14
BRP002R8L805FA	8.71	2.49	3.38	7.47	10.15	2.26	7.0	<16
BRP002R8L805FC	8.71	2.56	3.55	7.69	10.65	2.26	7.0	<16
BRP002R8L106FA	10.89	2.79	3.41	6.70	8.19	2.45	9.0	<20
BRP002R8L106FB	10.89	2.37	2.61	5.68	6.27	2.45	9.0	<20
BRP002R8L106FC	10.89	3.30	4.23	6.60	8.45	2.45	9.0	<20
BRP002R8L106FD	10.89	3.40	4.62	8.17	11.10	2.45	9.0	<20
BRP002R8L126FB	13.07	3.31	4.10	6.62	8.19	2.45	9.0	<24
BRP002R8L156FA	16.33	2.72	3.13	7.26	8.33	3.16	9.3	<30
BRP002R8L156FB	16.33	2.33	1.57	6.22	4.18	3.16	9.3	<30
BRP002R8L166FA	17.42	3.06	4.13	7.64	10.32	3.45	10.2	<32
BRP002R8L206FA	21.78	2.98	3.19	7.16	7.65	5.63	16.9	<40
BRP002R8L226FA	23.96	3.42	4.58	7.47	10.00	5.63	16.9	<44
BRP002R8L256FA	27.22	3.40	3.98	6.53	7.65	5.8	17.6	<50
BRP002R8L306FA	32.67	3.75	4.78	6.01	7.65	6.5	18.8	<60
BRP002R8L306FB	32.67	3.63	5.14	5.81	8.22	6.5	18.8	<60
BRP002R8L406FA	43.56	3.23	4.18	4.84	6.27	10.4	27.0	<80
BRP002R8L506FA	54.44	4.12	5.22	4.95	6.27	10.4	27.0	<100
BRP002R8L606FA	65.33	4.63	6.27	6.18	8.35	11.6	30.2	<120
BRP002R8L706FA	76.22	4.43	5.76	5.06	6.59	13.8	34.5	<140

## ◆ BIGCAP®Shape of standard product

Shape of snap-in and lead types supercapacitor:

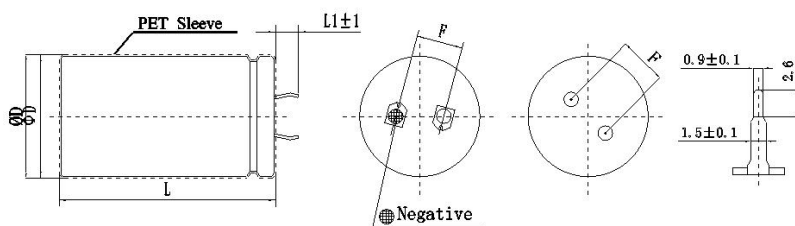

Φ	22.4	25.2	35.6
F	10		
L1	5.5	6.5	
L	45.5	52.5	61.5

Note: unit mm

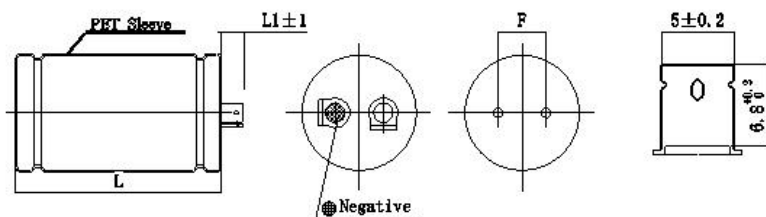

ΦD	35.6	
F	14	
L1	6.5	
L	61.5	93

Note: unit mm

## ◆ BIGCAP®Standard product specification

sheet3

Part Number	Nominal Voltage ,V dc	Capacitance F	Cap.olerance	ESR, mΩ		Size, mm ΦD×L	Weight g	Volume ml
				AC@1kHz	DC			
BRP002R8S606FA	2.8	60	±20%	14	16	22.4×45.5	18	17.92
BRP002R8S107FA	2.8	100	±20%	12	14	22.4×45.5	21	17.92
BRP002R8S157FA	2.8	150	±20%	12	14	25.2×52.5	31	26.17
BRP002R8S207FB	2.8	200	±20%	10	11	35.6×61.5	48.5	61.19
BRP002R8S307FA	2.8	300	±20%	8	9	35.6×61.5	60	61.19
BRP002R8S367FB	2.8	360	±20%	8	9	35.6×61.5	68	61.19
BRP002R8C207FB	2.8	200	±20%	10	11	35.6×61.5	48.5	61.19
BRP002R8C307FA	2.8	300	±20%	2.7	3	35.6×61.5	60	61.19
BRP002R8C307FB	2.8	300	±20%	8	9	35.6×61.5	60	61.19
BRP002R8C367FA	2.8	360	±20%	2.7	3	35.6×61.5	68	61.19
BRP002R8C367FB	2.8	360	±20%	8	9	35.6×61.5	68	61.19
BUP002R8C707FA	2.8	700	±20%	10	12	35.6×93	110	92.53

sheet4

Part Number	Max. Stored Energy, mWh	Energy Density		Power Density		$\Delta T=15^{\circ}\text{C}$ Nominal Current,A	Max Current,A	72hLC Leakage Current at 72h (25 $^{\circ}\text{C}$ ),mA
		Wh/kg Gravimetric	Wh/L Volumetric	KW/kg Gravimetric	KW/L Volumetric			
BRP002R8S606FA	65.33	3.63	3.65	6.81	6.84	6.0	50	<0.2
BRP002R8S107FA	108.89	5.19	6.08	6.67	7.81	6.5	65	<0.5
BRP002R8S157FA	163.33	5.27	6.24	4.52	5.35	7.7	70	<0.8
BRP002R8S207FB	217.78	4.49	3.56	3.67	2.91	8.0	80	<1.0
BRP002R8S307FA	326.67	5.44	5.34	3.62	3.56	9.0	85	<1.2
BRP002R8S367FB	392.00	5.76	6.41	3.20	3.56	9.4	90	<1.4
BRP002R8C207FB	217.78	4.49	3.56	3.67	2.91	8.0	80	<1.0
BRP002R8C307FA	326.67	5.44	5.34	10.89	10.68	20	160	<1.2
BRP002R8C307FB	326.67	5.44	5.34	3.62	3.56	9.0	85	<1.2
BRP002R8C367FA	392.00	5.76	6.41	9.61	10.68	25	180	<1.4
BRP002R8C367FB	392.00	5.76	6.41	3.20	3.56	9.4	90	<1.4
BUP002R8C707FA	762.22	6.93	8.24	1.48	1.77	11	100	<4.0

#### ◆ Typical characteristics

Product Standard	According to IEC 62391-1, GB/T2693—2001, Q/BIG001—2013 test standard	
Characteristics in Different Temperature	-40 $^{\circ}\text{C}$ ~+65 $^{\circ}\text{C}$	Compared with the initial value, $ \Delta C/C  \leq 30\%$ , ESR $\leq 4$ Initial specified value
Storage Temperature Range (at, 0V)	-40 $^{\circ}\text{C}$ ~+70 $^{\circ}\text{C}$	
Humidity Characteristics (at 25 $^{\circ}\text{C}$ , 90~95%RH)	240h	Compared with the initial value, $ \Delta C/C  \leq 30\%$ , ESR $\leq 2$ Initial specified value, no leaked electrolyte or other mechanical damage
Predicted Life at Normal Temperature (at U <sub>0</sub> ,25 $^{\circ}\text{C}$ )	10years	
High Temperature Life (at U <sub>0</sub> ,65 $^{\circ}\text{C}$ )	1000h	Compared with the initial value, $ \Delta C/C  \leq 30\%$ , ESR $\leq 4$ Initial specified value, no leaked electrolyte or other mechanical damage
Cycle Life (at U <sub>0</sub> ,25 $^{\circ}\text{C}$ )	500000times	
Shelf Life (at 0V,65 $^{\circ}\text{C}$ )	1000h	Compared with the initial value, $ \Delta C/C  \leq 20\%$ , ESR $\leq 3$ Initial specified value, no leaked electrolyte or other mechanical damage

<p>Self discharge characteristics (voltage holding characteristics) (at 25°C)</p>	<p>The voltage between the positive and negative electrode <math>\geq 2.1V</math></p>	<p>Charging process: normal temperature, non-loaded, charge at rated voltage for 24h Lay aside process: temperature less than 25°C, relative humidity less than 60%RH, lay aside 24h at open circuit</p>
---	---	--

◆ Markings

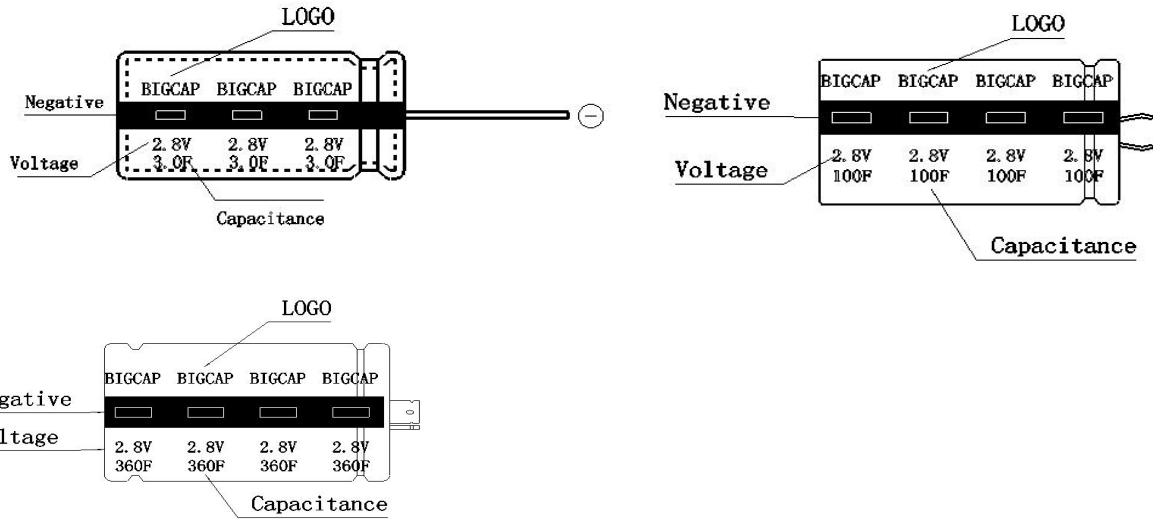

◆ Packaging method

Packaging of Wire Lead Supercapacitor:

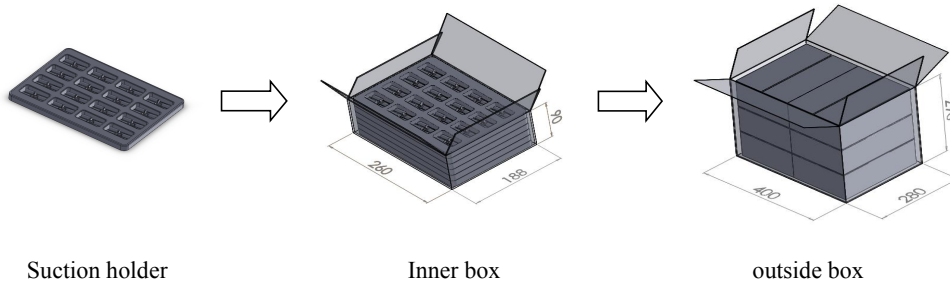

Packaging of Snap-in and Lead Types Supercapacitor:

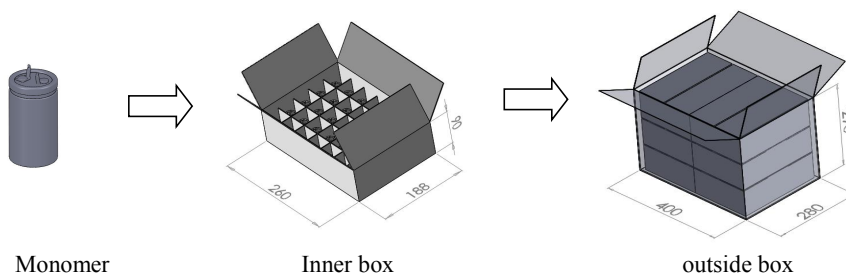

## ◆ Characteristic curve

(1) Characteristics in different temperature

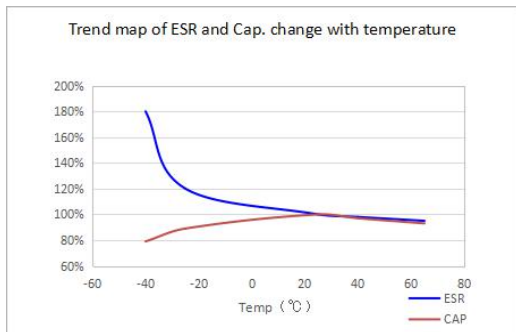

(2) LC characteristics

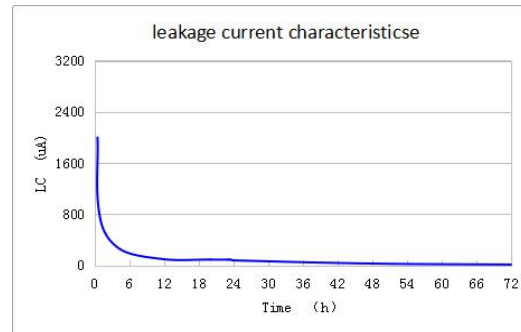

(3) High Temperature Life (at 2.8V,65°C)

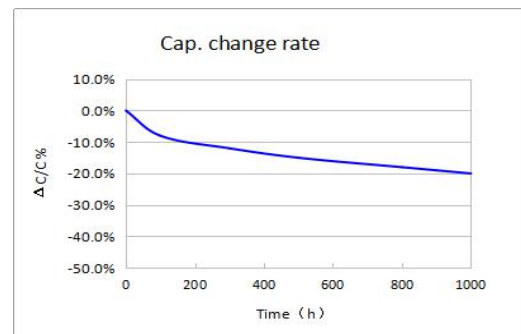
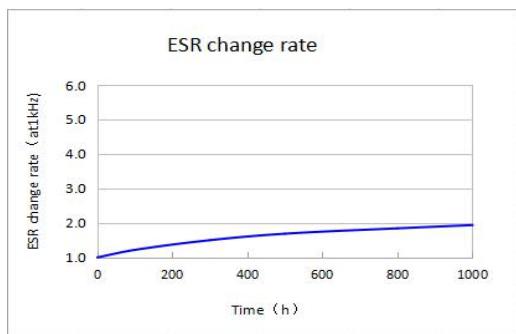

(4) LC characteristics

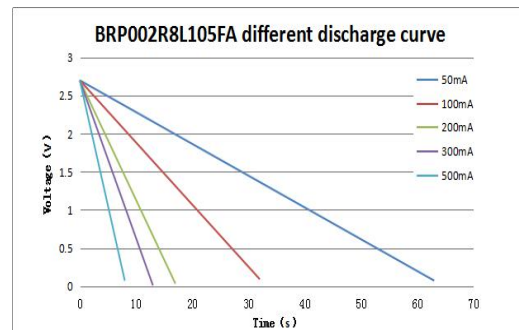
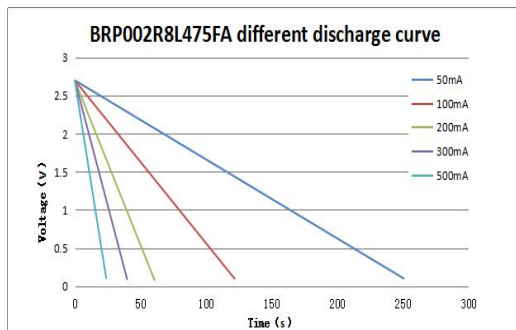

\*The above characteristic curves are trend charts. Please contact the manufacturer's technical support for the specific data of each model



◆ BIGCAP® Measuring Method of BIGCAP

Sheet5

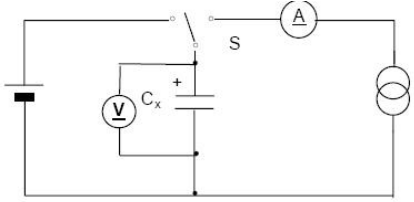
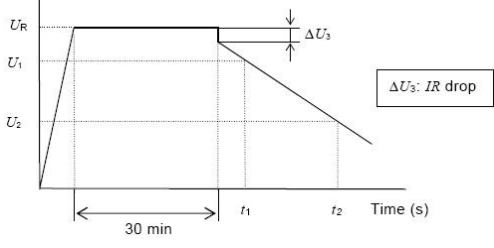
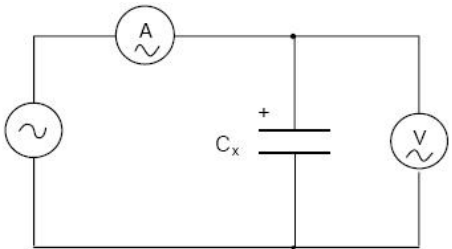
<p>Capacitance</p>	<p>Constant Current Discharge of Measure</p> <ol style="list-style-type: none"> <li>1、 Set the DC voltage source to the rated voltage (<math>U_R</math>)</li> <li>2、 Sets constant current values of a specified constant current discharge device.</li> <li>3、 Switch the switch S to DC power supply , constant voltage charge for 30min after the voltage reaches to rated voltage.</li> <li>4、 After charging 30min , transform the switch S to constant current discharge device the to discharge at constant current.</li> <li>5、 Measure the discharge time from <math>U_1</math> to <math>U_2</math> (<math>t_1</math>、 <math>t_2</math>), Calculate capacitance using the following formula:</li> </ol> <div style="display: flex; align-items: center;"> <div style="flex: 1;">  <p style="margin-left: 10px;">Constant current power supply</p> </div> <div style="flex: 1;">  </div> </div> $C = \frac{I \times (t_2 - t_1)}{U_1 - U_2}$
<p>Resistance</p>	<p>Equivalent series resistance:</p> <p>ESR shall be measured from the circuit below :</p> <div style="text-align: center;">  </div> <p>ESR <math>R_a</math> can be calculated from the formula : <math>R_a = \frac{U}{I}</math></p> <p>Equivalent series resistance ( m <math>\Omega</math> / <math>\Omega</math> ) ;</p> <p>U Ac voltage valid values ( V r. m. s ) ;</p> <p>I Ac current valid values ( V r. m. s ) 。</p>

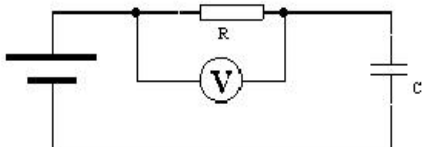
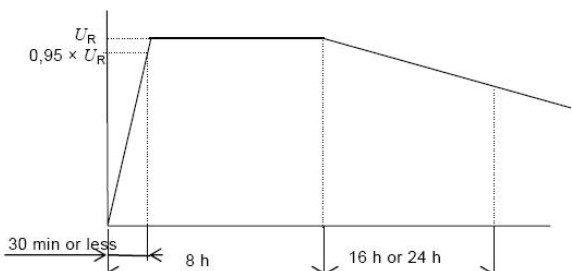
<p>Leakage Current</p>	<p>Leakage Current shall be measured from the circuit below :</p>  <ol style="list-style-type: none"> <li>1、 Discharge: Before the start of the measurement, supercapacitor should be fully discharge, discharge process for 1 h to 24 h.</li> <li>2、 Leakage current measurement shall be carried out under the rated temperature and voltage rating (UR) .The voltage of product reached 95% rated voltage after the biggest charging time for 30min, Charging time chooses from 30min (<math>\leq 1F</math>) , 1h (<math>\geq 1F</math>) , 2h (<math>\geq 10F</math>) , 4h (<math>\geq 20F</math>) , 72h (<math>\geq 120F</math>).</li> <li>3、 Should use a stable power supply, such as DC regulated power supply.</li> <li>4、 Charge process should be through the protection under <math>1000 \Omega</math> resistance.</li> </ol>
<p>Self discharge</p>	<p>Before the start of the measurement , super capacitor should be fully discharge, discharge process for 1 h to 24 h.Charge the super capacitor to rated voltage without protection Resistance,charging time for 8h(include the voltage of product reached 95% rated voltage after the biggest charging time for 30min ).Disconnect the super capacitor from the power supply.Super capacitor should be placed in the standard atmospheric pressure conditions for 24 h. Dc voltmeter internal resistance should be greater than <math>1 m \Omega</math> .</p> 

### ◆ Soldering Condition

The recommendation soldering conditions of the product in which flow soldering is possible are as graph.

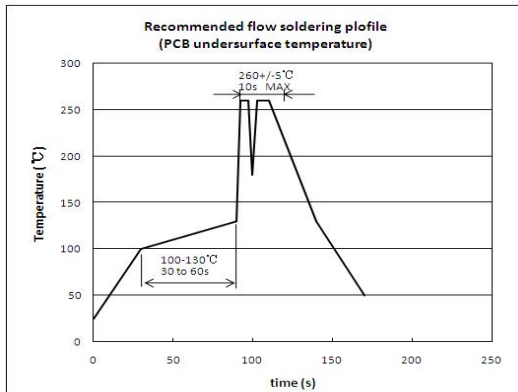

### Caution for Using aluminum Electrolytic Capacitors:

- 1、 Do not dip the capacitor into melted solder;
- 2、 Do not flux other part than the terminals;
- 3、 If there is a direct contact between the sleeve of the capacitor and the printed circuit pattern or
- 4、 a metal part of another component such as a lead wire, it may cause shrinkage or crack;
- 5、 If the application is for extended use, understand and manage the soldering characteristics to avoid
- 6、 abnormal current caused by a contact failure between the capacitor and the PCB;
- 7、 Please refer to product specifications about other notes.

### ◆ Cautions For Use

- (1) The problem of using different batches of supercapacitors

When using supercapacitors, we recommend that using the same batch of products, and don't mix up different batches of products.

- (2) The polarity of super capacitor

Unlike ordinary electrolytic capacitor or battery, the material of positive and negative polarity of super capacitor is same, so theoretically super capacitor has no polarity; the polarities marked on super capacitor are established by manufacturers in the production process, when the polarities are used reversely in short-term, it won't cause substantial damage on capacitor, and it can be used normally after adjusting to the right polarities. But if reversely use for a long time, the life of super capacitor will decay quickly.

- (3) Super capacitor charging information

To charge a super capacitor requires DC voltage that no more than the rated voltage. It can be charged by a variety of methods such as current limit, constant current, constant power, constant voltage ; When charging, the super capacitor may

lower the voltage of charging power supply until the capacitor is full to maintain voltage balance.

#### (4) Internal resistance and capacitance of super capacitor

In the process of charging and discharging, super capacitor's IR drop caused by inner resistance will leads to lose of efficiency of capacitor charging and discharging, so the size of capacitor determines the quality of capacitor to some extent; Due to the internal resistance of the super capacitor is higher than normal capacitors, so in the process of charge and discharge by AC circuit or high frequency circuit, super capacitor will become heating, and this cause life decay quickly, that's why super capacitor only commonly used in DC circuit.

Compared with ordinary capacitor, super capacitor has greater time constant  $\tau$ , so the charge and discharge time is longer; also because of this, it is not suitable for working with continuous large current frequently as it can cause performance decay rapidly. The frequency characteristic of super capacitor is: the response time of positive and negative ions in carbon electrode pore is longer, so the capacity appears very small. It is not allowed to measure super capacitor by using equipment for testing common capacitors and AC measuring methods, it should be measured by methods for measuring battery for mAh.

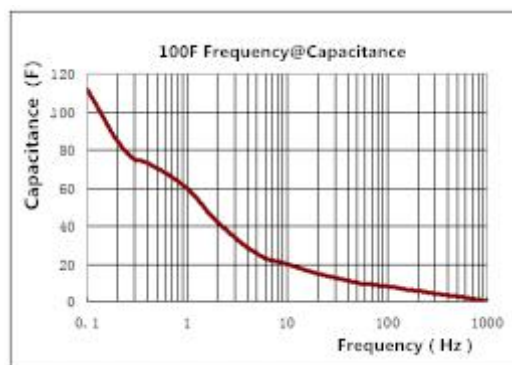

#### (5) Operating temperature and product

Generally, When BIGCAP<sup>®</sup> supercapacitors work at rated voltage and low temperatures, the leakage current will be less, the standby time and life will be longer. On the contrary, under the condition of rated voltage and higher temperature, the leakage current increases, the standby time is shortened, and the life is shortened. When the operating temperature is certain, the life will increase when working at the rated voltage.

#### (6) Transport and storage

Should prevent products be affected with damp in product transportation; The storage temperature should be -30 °C to 50 °C, relative humidity less than 60%, the maximum humidity no more than 85%, otherwise it will cause degradation of capacitor performance or rust.

#### (7) Installation and welding

When super capacitors are used for double-sided circuit boards, must pay attention that the joint should not contact

the capacitor, otherwise it will lead to short circuit, over-voltage and damage of capacitor. During the process of installation and after installation, do not twist or tilted the capacitor, do not be forcibly pull the wires. Capacitors should be welded after cutting off and bending the leads. In the welding process, pay attention to avoid overheating of the capacitor ( for a 1.6 mm thickness printed circuit board, the welding temperature should be 260 °C, time is not more than 5 s), circuit board and the capacitor should be clean after welding.

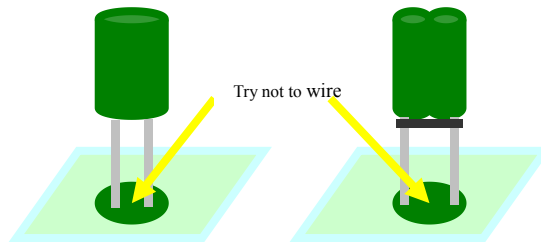

#### (8) The judgement of short circuit of Super capacitor

When short circuit, the capacitor can not be charged and discharged. Adopt a dc voltage between the positive and negative electrode of capacitor, if the voltage does not rise, then we can determine short circuit occurs; when using a multimeter to judge, when charging a new capacitor, it is a normal phenomenon that ohms shift (short circuit shift) display short circuit state, at this time, we can not make sure whether the capacitor is short circuit or not, we should observe whether the resistance value is increased, an increasing on resistance value means no short circuit occurs.

#### (9) Use in series and parallel

When same super capacitors used in series, the total voltage = capacitor number x capacitor voltage ; The total capacitance = single capacitor capacitance / capacitor number; Total energy = capacitor number x single capacitor' s capacitance; total resistance = capacitor number x single capacitor' s resistance.

There is a voltage balance problem when 3 pcs or above capacitors used in series, so an equalization circuit is required to ensure the capacitor will not over-voltage in long term use process, as over-voltage will cause decay and damage of capacitor. Different specifications of the super capacitor cannot be used in series.

Super capacitors in different capacitance value can be used in parallel, these capacitors should be charged by the same voltage, but should pay attention to the current balance problem between the capacitors and mutual isolation, to avoid potential difference happened after discharge.

#### (10) Other problems please consult the manufacturer or refer to BIGCAP® super capacitor relevant technical data.