

BK PRECISION[®]

Model 9103 and 9104

Multi-Range DC Power Supply

USER MANUAL



Safety Summary

The following safety precautions apply to both operating and maintenance personnel and must be followed during all phases of operation, service, and repair of this instrument.

WARNING

Before applying power to this instrument:

Read and understand the safety and operational information in this manual.

Apply all the listed safety precautions.

Verify that the voltage selector at the line power cord input is set to the correct line voltage. Operating the instrument at an incorrect line voltage will void the warranty.

Make all connections to the instrument before applying power.

Do not operate the instrument in ways not specified by this manual or by B&K Precision.

Failure to comply with these precautions or with warnings elsewhere in this manual violates the safety standards of design, manufacture, and intended use of the instrument. B&K Precision assumes no liability for a customer's failure to comply with these requirements.

Category rating

The IEC 61010 standard defines safety category ratings that specify the amount of electrical energy available and the voltage impulses that may occur on electrical conductors associated with these category ratings. The category rating is a Roman numeral of I, II, III, or IV. This rating is also accompanied by a maximum voltage of the circuit to be tested, which defines the voltage impulses expected and required insulation clearances. These categories are:

Category I (CAT I): Measurement instruments whose measurement inputs are not intended to be connected to the mains supply. The voltages in the environment are typically derived from a limited-energy transformer or a battery.

Category II (CAT II): Measurement instruments whose measurement inputs are meant to be connected to the mains supply at a standard wall outlet or similar sources. Example measurement environments are portable tools and household appliances.

Category III (CAT III): Measurement instruments whose measurement inputs are meant to be connected to the mains installation of a building. Examples are measurements inside a building's circuit breaker panel or the wiring of permanently-installed motors.

Category IV (CAT IV): Measurement instruments whose measurement inputs are meant to be connected to the primary power entering a building or other outdoor wiring.

WARNING

Do not use this instrument in an electrical environment with a higher category rating than what is specified in this manual for this instrument.

WARNING

You must ensure that each accessory you use with this instrument has a category rating equal to or higher than the instrument's category rating to maintain the instrument's category rating. Failure to do so will lower the category rating of the measuring system.

Electrical Power

This instrument is intended to be powered from a CATEGORY II mains power environment. The mains power should be 120 V RMS or 240 V RMS. Use only the power cord supplied with the instrument and ensure it is appropriate for your country of use.

Ground the Instrument

WARNING

To minimize shock hazard, the instrument chassis and cabinet must be connected to an electrical safety ground. This instrument is grounded through the ground conductor of the supplied, three-conductor AC line power cable. The power cable must be plugged into an approved three-conductor electrical outlet. The power jack and mating plug of the power cable meet IEC safety standards.

WARNING

Do not alter or defeat the ground connection. Without the safety ground connection, all accessible conductive parts (including control knobs) may provide an electric shock. Failure to use a properly-grounded approved outlet and the recommended three-conductor AC line power cable may result in injury or death.

WARNING

Unless otherwise stated, a ground connection on the instrument's front or rear panel is for a reference of potential only and is not to be used as a safety ground.

Do not operate in an explosive or flammable atmosphere

WARNING

Do not operate the instrument in the presence of flammable gases or vapors, fumes, or finely-divided particulates.

WARNING

The instrument is designed to be used in office-type indoor environments. Do not operate the instrument

In the presence of noxious, corrosive, or flammable fumes, gases, vapors, chemicals, or finely-divided particulates.

In relative humidity conditions outside the instrument's specifications.

In environments where there is a danger of any liquid being spilled on the instrument or where any liquid can condense on the instrument.

In air temperatures exceeding the specified operating temperatures.

In atmospheric pressures outside the specified altitude limits or where the surrounding gas is not air.

In environments with restricted cooling air flow, even if the air temperatures are within specifications.

In direct sunlight.

CAUTION

This instrument is intended to be used in an indoor pollution degree 2 environment. The operating temperature range is 0 °C to 40 °C and the operating humidity range is up to 80% relative humidity with no condensation allowed.

Measurements made by this instrument may be outside specifications if the instrument is used in non-office-type environments. Such environments may include rapid temperature or humidity changes, sunlight, vibration and/or mechanical shocks, acoustic noise, electrical noise, strong electric fields, or strong magnetic fields.

Do not operate instrument if damaged

⚠ WARNING

If the instrument is damaged, appears to be damaged, or if any liquid, chemical, or other material gets on or inside the instrument, remove the instrument's power cord, remove the instrument from service, label it as not to be operated, and return the instrument to B&K Precision for repair. Notify B&K Precision of the nature of any contamination of the instrument.

Clean the instrument only as instructed

⚠ WARNING

Do not clean the instrument, its switches, or its terminals with contact cleaners, abrasives, lubricants, solvents, acids/bases, or other such chemicals. Clean the instrument only with a clean dry lint-free cloth or as instructed in this manual.

Not for critical applications

⚠ WARNING

This instrument is not authorized for use in contact with the human body or for use as a component in a life-support device or system.

Do not touch live circuits

⚠ WARNING

Instrument covers must not be removed by operating personnel. Component replacement and internal adjustments must be made by qualified service-trained maintenance personnel who are aware of the hazards involved when the instrument's covers and shields are removed. Under certain conditions, even with the power cord removed, dangerous voltages may exist

when the covers are removed. To avoid injuries, always disconnect the power cord from the instrument, disconnect all other connections (for example, test leads, computer interface cables, etc.), discharge all circuits, and verify there are no hazardous voltages present on any conductors by measurements with a properly-operating voltage-sensing device before touching any internal parts. Verify the voltage-sensing device is working properly before and after making the measurements by testing with known-operating voltage sources and test for both DC and AC voltages. Do not attempt any service or adjustment unless another person capable of rendering first aid and resuscitation is present.

Do not insert any object into an instrument's ventilation openings or other openings.

WARNING

Hazardous voltages may be present in unexpected locations in circuitry being tested when a fault condition in the circuit exists.

Fuse replacement

WARNING

Fuse replacement must be done by qualified service-trained maintenance personnel who are aware of the instrument's fuse requirements and safe replacement procedures. Disconnect the instrument from the power line before replacing fuses. Replace fuses only with new fuses of the fuse types, voltage ratings, and current ratings specified in this manual or on the back of the instrument. Failure to do so may damage the instrument, lead to a safety hazard, or cause a fire. Failure to use the specified fuses will void the warranty.

Servicing

CAUTION

Do not substitute parts that are not approved by B&K Precision or modify this instrument. Return the instrument to B&K Precision for service and repair to ensure that safety and performance features are maintained.

Cooling fans

CAUTION

This instrument contains one or more cooling fans. For continued safe operation of the instrument, the air inlet and exhaust openings for these fans must not be blocked nor must accumulated dust or other debris be allowed to reduce air flow. Maintain at least 25 mm clearance around the sides of the instrument that contain air inlet and exhaust ports. If mounted in a rack, position power devices in the rack above the instrument to minimize instrument heating while rack mounted. Do not continue to operate the instrument if you cannot verify the fan is operating (note some fans may have intermittent duty cycles). Do not insert any object into the fan's inlet or outlet.

Use correctly sized wires

WARNING

To connect a load to the power supply, use a wire diameter large enough to handle the maximum continuous output short-circuit current of the power supply without the wire overheating.

For continued safe use of the instrument

Do not place heavy objects on the instrument.

Do not obstruct cooling air flow to the instrument.

Do not place a hot soldering iron on the instrument.

Do not pull the instrument with the power cord, connected probe, or connected test lead.

Do not move the instrument when a probe is connected to a circuit being tested.

Certification

We certify that this product met its published specifications at time of shipment from the factory.

Compliance Statements

Disposal of Old Electrical & Electronic Equipment (Applicable in the European Union and other European countries with separate collection systems).



This product is subject to Directive 2002/96/EC of the European Parliament and the Council of the European Union on waste electrical and electronic equipment (WEEE), and in jurisdictions adopting that Directive, is marked as being put on the market after August 13, 2005, and should not be disposed of as unsorted municipal waste. Please utilize your local WEEE collection facilities in the disposition of this product and otherwise observe all applicable requirements.

CE Declaration of Conformity

The power supply meets the requirements of 2006/95/EC Low Voltage Directive and 2004/108/EC Electromagnetic Compatibility Directive.

Low Voltage Directive

EN 60950-1

EN 61010-1

EMC Directive

EN 55011

EN 55022













EN 55024

EN61000-3-2

EN61000-3-3

EN61000-6-1

Safety Symbols

	Refer to the user manual for warning information to avoid hazard or personal injury and prevent damage to instrument.
	Electric Shock hazard
	On (Supply). This is the AC mains connect/disconnect switch on the front of the instrument.
	Off (Supply). This is the AC mains connect/disconnect switch on the front of the instrument.
	Direct current
	Alternating current
	Fuse Symbol
	Chassis (earth ground) symbol
	Ground terminal
	Protective earth ground
	CAUTION indicates a hazardous situation which, if not avoided, will result in minor or moderate injury
	WARNING indicates a hazardous situation which, if not avoided, could result in death or serious injury
	DANGER indicates a hazardous situation which, if not avoided, will result in death or serious injury.

Contents

Safety Summary	2
Compliance Statements	8
CE Declaration of Conformity.....	9
Safety Symbols	10
1 General Information.....	13
1.1 Product Overview	13
1.2 Package Contents	13
1.3 Input Power	14
1.4 Fuse Requirements.....	14
1.5 Fuse Replacement	14
2 Controls and Indicators	15
2.1 Front Panel	15
2.2 Rear Panel.....	16
3 Operating Instructions.....	17
3.1 Safety Precautions.....	17
3.2 Using Keypad and Control Knobs	18
Keypad.....	18
Control Knobs	18
3.3 Menu/Shift button and Key Lock button functions	18
Upper Voltage Limit (UVL).....	18
Upper Current Limit.....	18
To activate the Remote Control Mode.....	18
Deactivating Remote Control Mode	19
Factory Reset.....	19
Changing Ammeter to Wattmeter.	20
The Key Lock button	20
4 Operating Modes	21
4.1 Normal Mode	21
Powering on the power supply	21
Connect the device under test to the power supply.....	21
Turn on the Power Supply	22

Changing Ammeter to Wattmeter	22
Key Lock Function	22
Changing the values of UVL and UCL	23
4.2 Preset Mode	23
4.3 Transient Mode	24
Step Size (seconds)	25
Transition time:	25
Select First Step	26
Number of Cycles	26
Transient Mode: Examples	26
4.4 Analog Remote Control	31
How to Enter Remote Control Mode	31
To deactivate the Remote Control Mode	31
Analog Remote Control Methods and Set Ups	32
Analog Remote Control: Voltage Control.....	33
Remote Enable and Disable the Output.....	36
4.5 PC Interface Control	36
5 Remote Sensing	37
6 Protection Faults.....	38
6.1 OVP: Over Voltage Protection	38
6.2 OTP: Over Temperature Protection	38
6.3 OCP: Over Current Protection	39
7 Specifications	40
Service Information	42
Limited Two-Year Warranty.....	43

1 General Information

1.1 Product Overview

B&K Precision models 9103 and 9104 are multi-range power supplies differing from conventional power supplies because voltage and current limits are varied to allow maximum rated power to be delivered at any operating point. Contrast this to a conventional power supply which has a maximum voltage and maximum current rating -- all operating points must fall inside these limits.

This family of switching mode power supplies comes with a small form factor, auto cross-over for constant voltage (CV) and constant current (CC), 3 voltage/current presets for frequently-used settings, and remote control offering versatility for various applications.

The dual action (coarse/fine) tuning makes setting the voltage and current levels smooth, precise, and fast. Setting, changing, and checking the current limit level can be done without shorting the output.

Operating software through the USB interface allows turning the output power on or off and the voltage and current can be adjusted without using the front panel. Up to 20 timed steps of voltage and current, each with its own time duration from 1 s to 600 s, can be programmed for up to 999 cycles.

A DC ramp or pulsed waveforms can be generated by the front panel or by the supplied software with a preview of the final waveform. The 3 user defined presets facilitate quick access to frequently used VI settings.

1.2 Package Contents

Please inspect the instrument mechanically and electrically upon receiving it. Unpack all items from the shipping carton, and check for any obvious signs of physical damage that may have occurred during transportation. Report any damage to the shipping agent immediately. Save the original packing carton for possible future reshipment. Every instrument is shipped with the following contents:

- 1x 9103/9104 DC Power Supply
- 1x USB Cable
- 1x Analog Control Connector
- 1x AC Power Cord

- 1x Test Report

Verify that all items above are included in the shipping container. If anything is missing, please contact B&K Precision.

1.3 Input Power

The power supply has a universal AC input that accepts a line voltage with a nominal input of 110 V or 220 V AC. Use the line voltage selector switch in the back to switch between 110 V and 220 V operation.

⚠ WARNING

Disconnect all cables including the power cord from the instrument when changing the instrument's line voltage. After changing the line voltage setting, ensure the instrument has fuses of the proper ratings and types for the selected line voltage before applying line power.

1.4 Fuse Requirements

An AC input fuse is necessary when powering the instrument. Below is a table of the fuse required for all models operating with either 110 VAC or 220 VAC input.

Model	Fuse Specification (110 - 240VAC)
9103	T5AL 250V
9104	T5AL 250V

Table 1 - Fuse Specifications

1.5 Fuse Replacement

Follow the steps below to replace or check the fuse.

1. Locate the fuse box next to the AC input connector in the rear panel.
2. With a small flat blade screwdriver, insert into the fuse box slit to pull and slide out the fuse box as indicated below.
3. Check and replace fuse if necessary.

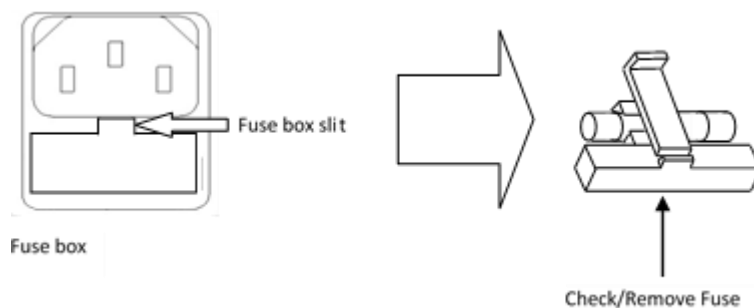

Figure 1 - Replacing a Fuse

2 Controls and Indicators

2.1 Front Panel

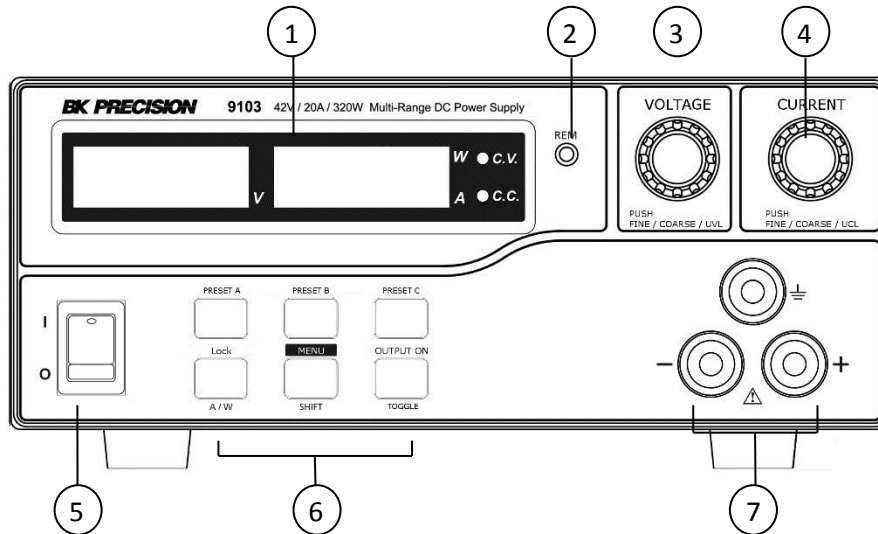

Figure 2 - Front Panel

- ① LED panel meter display with CV/CC/W (constant current/constant voltage/power) indicator
- ② Remote Control Indicator (shows Remote Control/USB mode)
- ③ Output Voltage Control Knob (UVL upper voltage limit)
- ④ Output Current Control Knob (UCL upper voltage limit)
- ⑤ Power ON/OFF Switch
- ⑥ Illuminated Keypad:
 - Preset Key A, B & C
 - Menu Key (Shift Key)
 - Lock/ Unlock Key (amperes/watts meter key)
 - Output ON/OFF ($\Delta V/\Delta t$ Key)
- ⑦ Output Terminals

2.2 Rear Panel

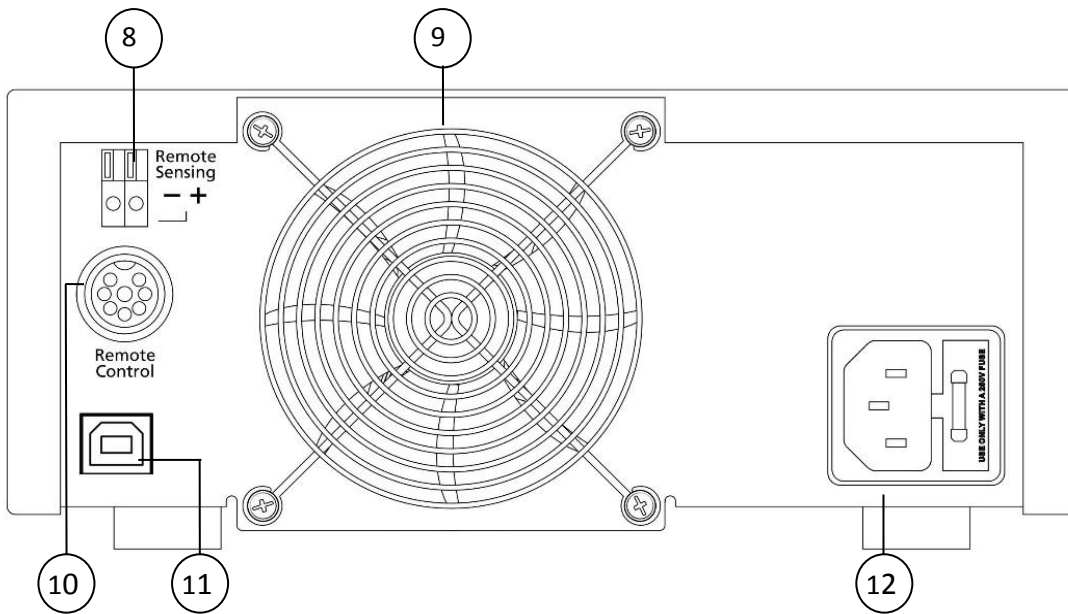

Figure 3 - Rear Panel

⑧ Remote Sense



Shorting the remote sensing terminal or connecting the sense terminals with reversed polarity will damage the power supply.

⑨ Thermostatically controlled cooling Fan

⑩ Analog Remote Control Terminal

⑪ USB Port

⑫ AC Input Socket with Fuse Compartment

3 Operating Instructions

3.1 Safety Precautions

WARNING

- Do not use this power supply near water.
- Do not operate or touch this power supply with wet hands.
- Do not open the casing of the power supply when it is connected to AC mains.
- All servicing by qualified service personnel.
- Before replacing the AC fuse, determine and fix the cause of the over-current condition.
- Replace the AC fuse with the same type and rating as the original fuse.
- The maximum output voltage of the Model 9104 can be over 60 volts. Avoid touching the output terminals.
- Series or parallel connection of 2 power supplies is not allowed.

CAUTION

- Use a grounded 3 prong AC receptacle.
- This unit is for indoor use only.
- Do not operate or place this unit in a humid or dusty environment, in direct sunlight, or near any heat source.
- Before plugging into local AC power, check that the rating label on the back of the unit matches the power outlet's characteristics.
- Do not block any ventilation openings of the unit.
- This unit must be used within its specified ratings. Regular excessive loading may damage the power supply.
- When using the Remote Sense function, never short the Remote Sensing Terminal or use the output on-off switch on the front panel or via Analog Remote Control or Remote Programming.
- The input power cable conductors must be at least 0.75 mm² and the total length of the power cable must not exceed 3 m.

3.2 Using Keypad and Control Knobs

Keypad

An activated button will be illuminated. The three buttons in the lower row have dual functions which work in conjunction with other lower buttons or with the voltage, current control knobs as defined by the green labels.

Throughout this manual the Menu button also acts as the Shift button. When used to enter the menu mode, the button is pressed and held, when used for a Shift function, it is pressed momentarily.

Control Knobs

The rotary encoder control knobs provide fine and coarse tuning with detents.

Push the knobs to toggle through the adjustable digit values (note the brightness change in the affected LED to signify the selected digit).

Adjust the knobs as needed. The display will resume its normal brightness after few seconds to confirm your adjustment.

3.3 Menu/Shift button and Key Lock button functions

Upper Voltage Limit (UVL)

- a) To set the UVL, press the "Shift" button and then press the Voltage control knob.
- b) The voltmeter will show the present limit and the Ammeter will show SUuL.
- c) Tune the Voltage control knob to your desired limit value.
- d) Press the "Shift" key to confirm and return to normal operation.

Upper Current Limit

- a) To set the UCL, press the "Shift" Key and then press the Current control knob.
- b) The Ammeter will show the present limit and the Voltmeter will show SUCL.
- c) Tune the Current control knob to your desired limit value.
- d) Press the "Shift" key to confirm and return to normal operation.

To activate the Remote Control Mode

- a) Press and hold the "Menu" Key for 3 seconds.

- b) Turn the Voltage control knob until the panel meter displays wording rC SEt as below.



Figure 4 - Remote Control Display

- c) Press the Voltage control knob to confirm the entry into remote control mode.
d) Turn the Current control knob to select remote ON or OFF.
e) Press the Voltage control knob to confirm and return to Set menu.
f) Press the Menu key to leave the Set menu.

Note: After activating the Remote Control Mode, all function keys on the front panel will be Locked and the Lock/Unlock key and Remote LED light up.

Deactivating Remote Control Mode

- a) Press the Lock/Unlock key to unlock all the function keys.
b) Repeat step above, but set to OFF at steps **d, e**.

Factory Reset

- a) Press and hold the “Menu” Key for 3 seconds.
b) Turn the Voltage control knob until the panel meter displays “FACS SEt” as below.
c) Press the Voltage control knob to confirm to entry the Factory Reset mode.



Figure 5 - Factory Reset Display

- d) Turn the Current control knob to select Yes or No.
e) Press the Voltage control knob to confirm.
f) Press the Menu key to leave the Set menu.

The power supply has returned to the factory settings of the 3 Presets and Upper Voltage and Current limits.

Changing Ammeter to Wattmeter.

This function is only valid when the output on/off is set to on.

- a) Press Output ON/OFF to ON.
- b) Press the "Shift"/ (Manual) key and then press the "Lock/Unlock" key.
- c) Note the orange "W" next to the green "CV" to indicate the power in watts is being displayed.
- d) To change from Wattmeter to Ammeter, press the "Shift" key and then press "Lock/Unlock" key.

The Key Lock button

- a) Press the "Lock/Unlock" key to lock or unlock all function keys and the control knob on front panel.
- b) The "Lock/Unlock" key lights up when the keys are locked.

4 Operating Modes

These power supplies have the following modes of operation:

- Normal
- Preset
- Transient Mode
- Remote Control
- Remote Programming

The power supply is factory preset to Normal Mode with the maximum specified current level and the supply is in constant current mode.

4.1 Normal Mode

<i>Model</i>	<i>Output Voltage Range</i>	<i>Total Rated Current</i>
9103	0 - 42V ($I \leq 7.6A$ for 42V)	0 - 20A ($V \leq 16V$ for 20A)
9104	0 - 84V ($I \leq 3.8A$ for 84V)	0 - 10A ($V \leq 32V$ for 10A)

Table 2 - Power Ranges

Maximum values of voltage and current are limited by the maximum output power of 320 W. Decrease the voltage setting to get a higher current and vice versa for high voltage.

Powering on the power supply

After the unit is turned on, the CV, V and A LED indicators are lit up, displaying the set voltage. The current is set to 00.00. The output on-off button is set to off by default. Push the voltage/current knob or turn one click in either direction to see the present settings. Both displays return to 00.00 after a few seconds.

Connect the device under test to the power supply

Red (+) is connected to the positive terminal and black (-) is connected to the negative terminal. Connect equipment to be powered with the power supply output off. Connect a grounding wire as needed (be cautious to avoid ground loops).

Due to the high current rating of the power supply, proper wire sizes are necessary for safe connectivity and to prevent wires from overheating. Refer to the table below as a reference for proper wire sizes according to the amount of current used for operation:

AWG	6	8	10	12	14	16	18	20	22
I_{max}(A)	75	55	40	25	20	13	10	7	5
mΩ/meter	1.3	2.1	3.3	5.2	8.3	13.2	21	33.5	52.8

Table 3 - Wire Gauges

⚠ WARNING

Before connecting wires to the output terminals, turn OFF the power supply to avoid damage to the instrument and the device under test (DUT). For safety, load wires must have a wire gauge size large enough to prevent overheating when the power supply operates at maximum short circuit output current. It will also prevent large voltage drops from resistances in the wires.



Hazardous voltages may exist at the outputs and the load connections when using a power supply with a rated output greater than 40V. To protect personnel against accidental contact with hazardous voltages, ensure that the load and its connections have no accessible live parts. Ensure that the load wiring insulation rating is greater than to the maximum output voltage of the power supply.

Turn on the Power Supply

- Press the Output On/Off button.

Voltage and current will be displayed continuously and CV or CC will be lit according to the settings and the value of the connected device under test.

When operation or testing is finished, turn off the device under test first and then switch off the power supply.

Changing Ammeter to Wattmeter

This function is only valid when the output on/off is set to on.

- Press the “Shift” (Menu) key and then press the “Lock/Unlock” key to change Ammeter to Wattmeter.

The unit is in Wattmeter display mode.

- To change back to Ammeter display mode, press the “Shift” key and then press the “Lock/Unlock” key.

Key Lock Function

This function prevents any inadvertent changes on the voltage and current settings.

- Press the “Lock/Unlock” key to lock or unlock all function keys and control knob on the front panel.

The “Lock/Unlock” key lights up when the keys are locked.

Changing the values of UVL and UCL

These functions are designed to give additional protection for voltage sensitive and/or current-sensitive loads. When the voltage or current at the output terminal exceed the UVL or UCL set limits, the output will be turned off.

- **UVL setting:** Press the SHIFT “Menu” Key to light up, then press the VOLTAGE control knob.

The voltmeter will show the present voltage limit and the Ammeter will show SUuL. Turn the Voltage control knob to your desired limit voltage. Press the SHIFT “Menu” key to confirm with light out and return to normal operation.

- **UCL setting:** Press the SHIFT “Menu” Key to light up, then press the CURRENT control knob. The voltmeter will show the SUCL and the ammeter will show the present current limit. Turn the CURRENT control knob to your desired limit current. Press the SHIFT “Menu” key to confirm with light out and return to normal operation.

Note: The UVL and UCL settings are factory preset at maximum rated output values.

The UVL and UCL settings will affect the usable voltage range and current range and will trigger the respective protection if the set limits are exceeded.

If the remote sense function is used, allowance must be included in the setting of UVL for the gain in output voltage.

4.2 Preset Mode

There are 3 preset outputs (Preset A/ Preset B/ Preset C)

- Press the Preset key A or B or C to use the preset voltage and current settings; the key will light up.
- To check the preset values without affecting the output, press the “Shift” Key and then the selected Preset Key.
- The V and I settings of corresponding PA, PB, PC will be show on the panel meters.
- To change the values of the Presets, press the desired preset key (it will light up) and adjust the voltage/current level, the set values will be brighter than the measured values.

- The newly set values of the Preset will be kept even after the power supply has been turned off.
- The factory default settings of the 3 Presets are shown in the following table.



Always check the voltage & current level of the Preset before setting output to on when connected to a load.

Factory	Output Voltage	Output Current
Preset A	9103: 5V	9103: 20A
	9104: 5V	9104: 10A
Preset B	9103: 13.8V	9103: 20A
	9104: 13.8V	9104: 10A
Preset C	9103: 20V	9103: 16A
	9104: 20V	9104: 8A

Table 4 - Preset Mode

4.3 Transient Mode

This feature uses the 3 Presets from the previous section to generate the Ramp Up/Down and other waveforms such pulse, triangular, trapezoid, etc. by varying the voltage level, duration time (**Func**) at each voltage level and time interval (**Δt**) to move from one voltage to another voltage level. The number (**Runt**) of repetitive cycles of the waveform can be set as well. At the end of the run cycle run, the output will be turned off.

It is recommended that the computer interface be used instead of panel programming to operate this function as the simulated open circuit output wave forms can be previewed at the PC and settings are made more conveniently and be saved. The output waveform data can be logged for reference.

Note:

- The Transient Mode is independent from the output state. It is recommended to set the voltage and current to zero before enabling this mode.
 - Turn the output off by pressing the OUTPUT ON button (make sure the backlight is off).
 - Set the voltage and current to 0 V and 0 Amps.
 - Turn the output on by pressing the OUTPUT ON button (make sure the backlight is on).
 - Run the transient: Press the Menu button (Shift function)+ Toggle button.
 - Turn the output off by pressing the OUTPUT ON button (make sure the backlight is off).
 - Turn the transient off by pressing the Menu button (Shift function) +Toggle button.
-

The voltage knob will allow the user to navigate through the options of the Transient Mode and the Current knob will set the values of the options. Press the voltage knob to enter the value and exit the current menu and to exit the main menu, press the Menu Button.



Figure 6 - Sequence Menu: dvdt set

Step Size (seconds)

This menu allows the user to enter the step size (duration of a Preset value). Range: 0 to 600 s



Figure 7 - Step size (seconds)

Transition time:

This is the time the power supply will take from the first preset value to the second. Range: 0 to 20 s.

Options: **A_b_ b_A_ A_C_ C_A_ b_C_ C_b_**



Figure 8 - Transition Time

Select First Step

This option allows the user to select a transition to start the sequence.

Options: rUN A_b rUN b_A rUN A_C rUN C_A rUN b_C rUN C_b



Figure 9 - Selecting First Step

Number of Cycles

Runt means number of cycles the power supply will run before stopping. Setting **Runt** to all zeroes implies infinite.



Figure 10 - RUN T - Number of Cycles

Note: If a transition is selected between two preset voltages, and one of those voltages is not set, the sequence will not run properly.

Transient Mode: Examples

Note: The Transient Mode is independent from the output state. It is recommended to set the voltage and current to zero before enabling this mode. The backlight of the PRESET values being used will toggle to show the current step.

-
- Turn the output off by pressing the OUTPUT ON button (make sure the backlight is off).
 - Set the voltage and current to 0 V and 0 Amps.
 - Turn the output on by pressing the OUTPUT ON button (make sure the backlight is on), now, current and voltage are set to zero.
 - Run the sequence: Press the Menu button (Shift function) + Toggle button.
 - Turn the output off by pressing the OUTPUT ON button (make sure the backlight is off), sequence will continue running, but there will be no output.
 - Turn the sequence off by pressing the Menu button (Shift function) +Toggle button.
-

Example 1: Pulse waveform

1. Press PRESET A button and set 10 V using the Voltage knob and using the current knob enter 1 Amp. Following this procedure also configure PRESET B with values 5 V and 1 Amp.
2. Press and hold the Menu button (~4 seconds).
3. Use the Voltage knob to find the **du dt Set** then press the Voltage knob to enter the menu.
4. Use the Voltage knob to navigate to the FunA screen and enter a time of 3 seconds (003) by rotating the current knob and press the Voltage knob to enter this value.
5. Rotate the Voltage knob to navigate to the FUNB screen and adjust the time following the procedure in step #4, but this time set the FUNB value to 003.
6. Rotate the Voltage to navigate to the FUNC screen and adjust the time following the procedure in step #4, but this time set the FUNC value to 000 since this preset will not be used.
7. In the same menu, **du dt Set**, use the Voltage knob to set the transition time from preset A to preset B by setting A_b_ to 0000 and b_A_ also 0000.
8. Also, set the run to A_b to indicate a transition from PRESET A to PRESET B.
9. Set **rUNt** to 0000 which means “cycle indefinitely”.
10. To generate the waveform, push the “Shift” key and then press the “Output on” button.

The waveform will repeat cyclically if rUNt 0000 is set to 0000 or according to number of cycles entered. The output will show a pulse waveform with 3 seconds at 10 V and 1 second at 5 V.

11. Press the OUTPUT ON button to turn the output off (backlight should be off, too).
12. To stop the cycle running, push the “Shift” key and then press “Output on” button.

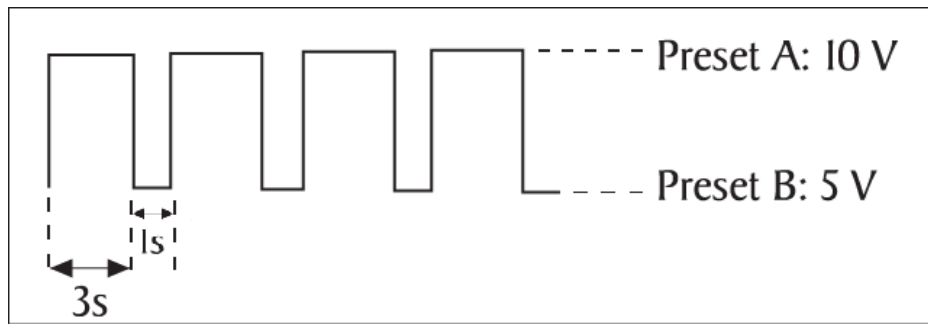

Figure 12 – Sequence Mode: Example 1

Example 2: Generating a Ramp

- a) Make sure that the voltage and current of the Presets have been set first.
In this example, we use Preset A = 5V, Preset B = 10V
- b) Press and hold the Menu button (~4 seconds).
- c) Using the voltage knob, navigate to the “**du dt SET**” option (transient mode).
- d) Press the VOLTAGE KNOB to enter the transient mode.
- e) Set these parameters with the following values:
 - **Func A=0 sec.** Displays “FUNCA 0000”. Step size for Preset A.
 - **Func b=15 sec.** Displays “FUNCN 0015”. Step size for Preset B.
 - **ΔV a-b =** Displays “rUN A _ b”. This step selects the first step.
 - **Δt a-b = 5 sec:** Displays “A_b_0005”. This step sets the transition time from A to B to 5 seconds.
 - **Run t = 3 cycles:** Displays “runt 0003”. Set the sequence to run 3 times.
- f) In each option, make sure to press the Voltage Knob to enter the values. Press the Menu Key to exit this Menu.
- g) To generate the waveform, push the “Shift” key and then press the “Output on” button.
- h) Press the OUTPUT ON button to turn the output off (backlight should be off, too).
- i) To stop the cycle running, push the “Shift” key and then press “Output on” button.

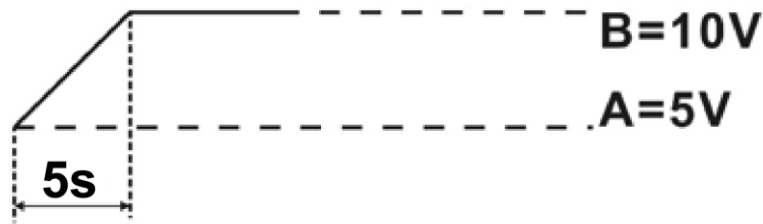

Figure 13 - Sequence Mode: Example 2

Example 3: Triangular

Using the same procedure as above

13. Set $A = 5V$, $B = 10V$
14. Set Δt a-b = 3 seconds , Set Δt b-a = 3 seconds
15. Set Func. A = 3 seconds, Set Func. B = 3 seconds



Figure 14 - Transient Mode: Example 3

Example 4: Trapezoid

Using the same procedure as above

- Set $A = 5V$, $B = 0V$
- Set Δt b-a = 3 seconds , Set Δt a-b = 8 seconds
- Set Func. A = 5 seconds, Set Func. B = 2 seconds

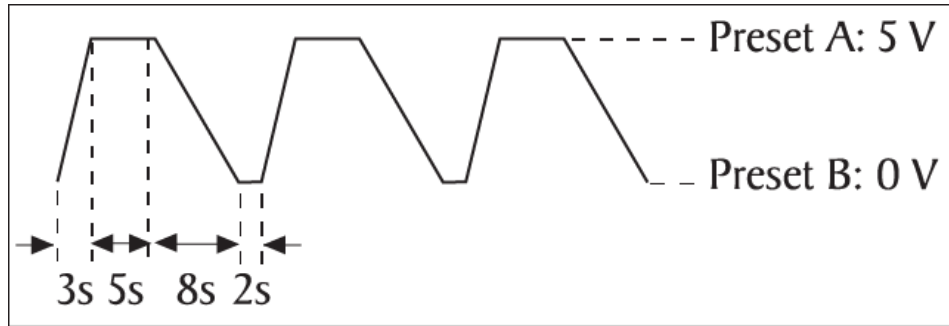

Figure 15 - Transient Mode: Example 4

Note: Waveform generation can be operated via the remote programming software with preview of the waveform and data logging of the output.

4.4 Analog Remote Control

There are two methods to remotely control the voltage and current output of these units: voltage control and resistance control.

Note: Both analog methods require the remote control connector plug to be set up in order for analog remote control mode to be functional; otherwise the unit will be in CC mode all the time.

How to Enter Remote Control Mode

- a) Press and hold the “Menu” Key for 3 seconds.
- b) Tune the Voltage control knob until the panel meter displays rC SEt as below. Press the Voltage control knob to confirm to entry into remote control mode.



Figure 16 - Remote Control Mode

- c) Turn the Current control knob to select remote ON.
- d) Press the Voltage control knob to confirm and return to the Set menu.
- e) Press the Menu key to leave the Set menu.
- f) The orange REMOTE LED, LOCK/UNLOCK button, and OUTPUT ON/OFF button will be on to confirm the unit is in Analog Remote Control Mode.
- g) All the buttons and keys on the front panel are locked except the lock/unlock key.

To deactivate the Remote Control Mode

- a) Press the Lock/Unlock key to unlock all the function keys.
- b) Repeat the previous steps a to c and at step c select OFF.

Analog Remote Control Methods and Set Ups

After entering into Remote Control Mode, the following external set ups can be selected. There are two methods for remote control of current and voltage adjustment.

Both methods require both the current remote control part and the voltage remote control part to be set up and in use at the same time in order for the analog remote control mode to be functional.

Otherwise the power supply will be in CC mode and the analog remote control will **not** be functional.

Setting up the provided remote connector plug:

- a) Remove the black portion of the remote control connector plug by removing the screw as shown in **Figure 17** - Remote Control Connector.

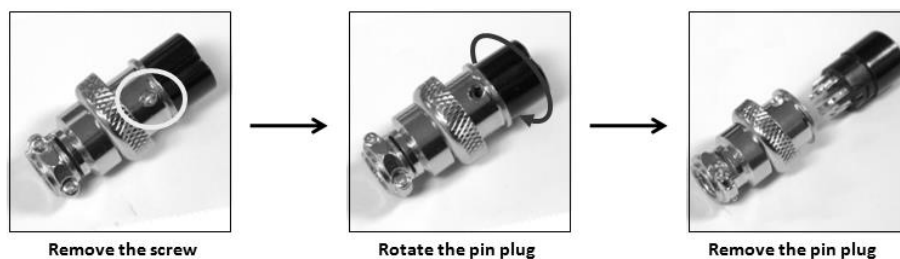

Figure 17 - Remote Control Connector

- b) Solder 5 wires (22AWG) to pins 1, 2, 3, 4, and 5 of pin plug. Refer to **Figure 18** for pin numbers.

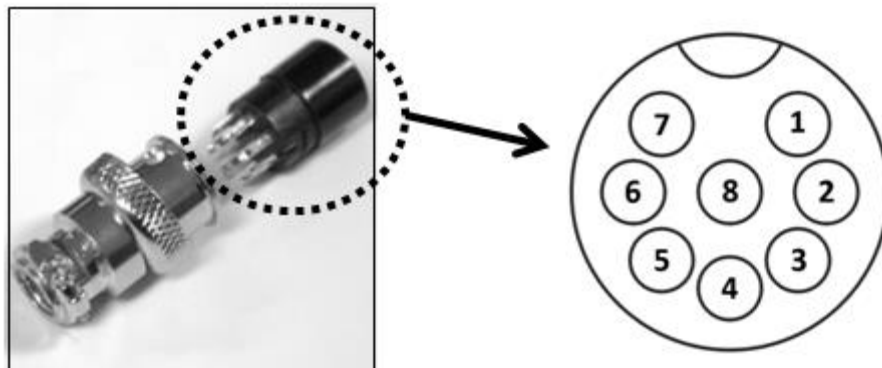

Figure 18 - Pin Numbers

- c) Make sure the load is disconnected and the power supply is OFF.

- d) Plug the remote connector plug into the analog remote control terminal of the power supply.
- e) Secure the remote connector plug to the terminal socket by screwing in the connector ring (**Figure 19**).

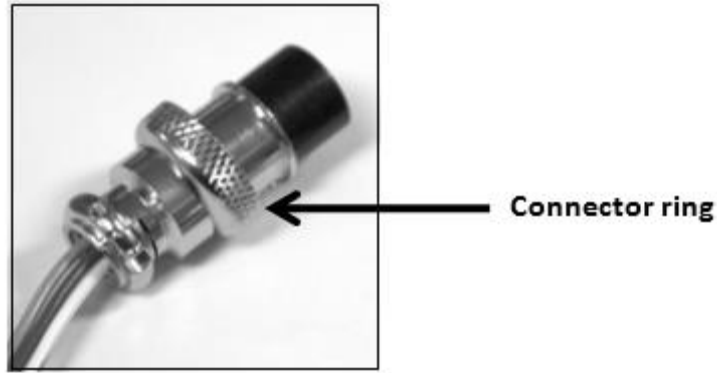

Figure 19 - Connector Ring

Then, you can choose one of the following two methods to use the analog remote control feature:

- Using two external variable DC voltage sources, or
- Using two 5 k Ω variable resistors.

Analog Remote Control: Voltage Control

A variable external DC voltage source of 0 – 5 V is fed into the analog remote control terminal to adjust the output voltage level of both Main and Auxiliary output.

PIN	FUNCTIONS	REMARKS
1	Internal DC +5 V	Less than 50 mA
2	Voltage Adjust	0 – 5 V
3	Current Adjust	0 – 5 V
4	Ground	
5	Output OFF	Short to Ground
6	N/A	

7	N/A	
8	N/A	

Table 5 – Analog Remote Control Connector Pinout: Voltage Control



WARNING

Do not input higher than 5 V, otherwise the overvoltage protection (OVP) will be triggered.

Steps to configure Voltage Control:

1. Make sure the load is disconnected and the power supply is OFF.
2. Connect pin 2 to positive polarity of first external voltage source and pin 4 to negative polarity of first external voltage source.
3. Connect pin 3 to positive polarity of second external voltage source and pin 4 to negative polarity of second external voltage source.
4. Turn the remote control ON/OFF switch to ON position.
5. Switch on the power supply.
6. Check the output voltage range of the power supply by varying the external voltage source for voltage adjustment from 0 to 5 V.
7. Short circuit the main output with a 12AWG wire and check the display for CC setting by varying the external voltage source for current adjustment from 0 to 5 V.
8. Switch off the power supply.

Analog Remote Control: Resistance Control

Using two variable resistor of 5 kΩ can be used to adjust the output voltage level of both Main and Auxiliary output.

Steps to configure Resistance Control:

1. Make sure the load is disconnected and the power supply is OFF.
2. Prepare two 5 kΩ variable resistors and connect wires from pins 1, 2, 3, and 4 as shown in **Figure 20** -Variable 5 kΩ Resistors Setup

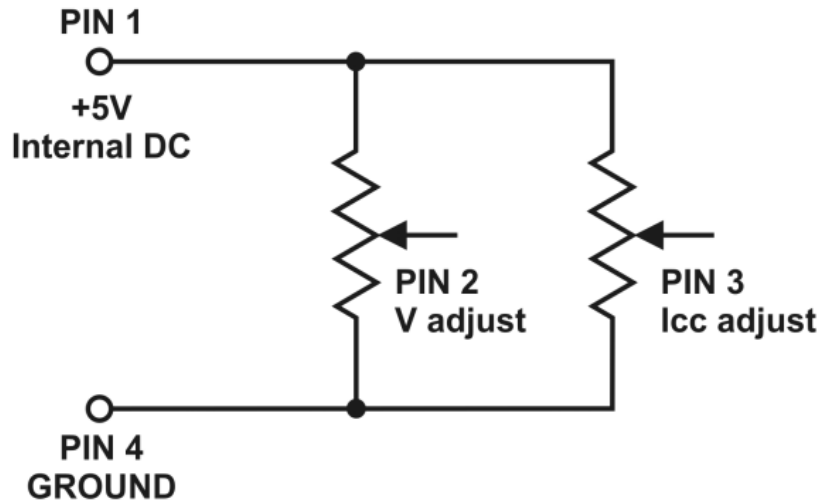

Figure 20 -Variable 5 kΩ Resistors Setup

PIN	FUNCTIONS	REMARKS
1	Internal DC +5 V	Resistor end
2	Voltage Adjust	Variable part of resistor
3	Current Adjust	Variable part of resistor
4	Ground	Resistor end
5	Output OFF	Short to Ground
6	N/A	
7	N/A	
8	N/A	

Table 6 - Analog Remote Control Connector Pinout: Voltage Control

3. Turn the remote control ON/OFF switch to ON position.
4. Switch on the power supply.
5. Check the output voltage range of the power supply by varying the 5 kΩ variable resistor for voltage adjustment.

6. Short circuit the main output with 12AWG wire and check the display for CC setting by varying the 5 k Ω variable resistor for current adjustment.
7. Switch off the power supply.

Remote Enable and Disable the Output

This remote output on/off control can be activated in any of the following modes: Normal, Preset, Remote, and Set mode.

- a. By default, Pin 5 is open and output is on.
- b. Shorting Pin 5 to Pin 4 (ground) and output is off.
- c. When the output is off, the CV and CC LEDs will flash. The current output voltage and current setting will show on the panel meter.
- d. You also can adjust the output by the voltage and current control knobs to the desired value when the output is off.

Note: using the 8 pin remote plug provided and connect with 22 AWG wires.

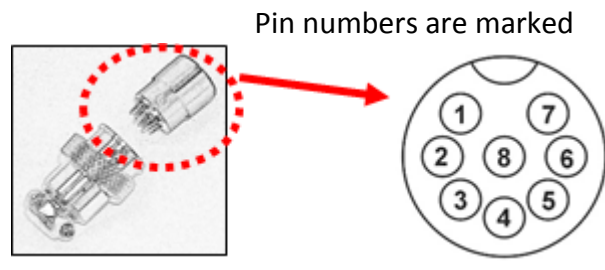

Figure 21 - Analog Remote Control Connector

⚠ WARNING

Do not use remote output on/off control when power supply is in Remote Sense connection.

The power supply can be damaged due to the high current going through the thin remote sense wires.

4.5 PC Interface Control

This PC Interface Mode connects the power supply to a PC via USB PORT. Application software for wave form generator, external timed programs, data logging of output with I, V, W with time span and the setting of miscellaneous parameters limits. Go to www.bkprecision.com to download the Operating Software and Programming Manual for this power supply.

Note: The power supply does not need to have Remote control enabled to be controlled via the PC interface.

5 Remote Sensing

⚠ WARNING

- Never short the Remote Sensing Terminal.
- An incorrect disconnection sequence will damage the Power Supply.
- Always disconnect the Remote Sensing Terminal first.
- DO NOT USE Output On Off on front panel or by remote operation.
- It is recommended you use the key lock function to prevent accidental switching off the output by the output on/off switch.
- Never connect the Remote Sensing Terminals in reverse polarity.

Connections:

1. Make the power connections between the power supply and the equipment.
2. Check and make sure the power connections are secure.
3. Make the connections between the Remote Sensing terminals and the equipment.

Figure 22 shows the connections between the Remote Sensing terminals, Power output terminals, and the equipment.

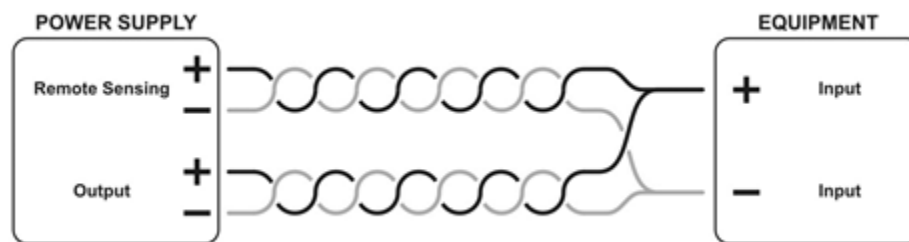

Figure 22 - Remote Sensing

Disconnecting Remote Sensing

1. First disconnect the remote sense connections.
2. Then disconnect the power connections between the power supply and equipment.

Remote Sense commonly compensates for output line voltage drops of about 0.25 to 0.75V. Use Twisted Remote Sense wires and shielding to minimize noise.

6 Protection Faults

6.1 OVP: Over Voltage Protection

This unit has a built-in over voltage protection feature. In the event the output voltage exceeds the set OVP voltage value (see the specified range from specifications table), the protection will be triggered and the output power will be turned off and the OVP warning appears as below.



Figure 23 - OVP Warning

To reset the warning:

1. Remove the connection to the load and press the Output ON/OFF key.
2. Reconnect the load and normal operation should be resumed. If this problem persists, please consult with BK Precision.

6.2 OTP: Over Temperature Protection

There is a temperature sensor inside the unit to prevent the power supply from getting too hot. At OTP, there is no output and the following warning will appear on the LED display. When you get this warning, switch off the unit and disconnect the load.



Figure 24 - OTP Warning

Check the load and output setting. Allow the unit to cool down for at least 30 minutes. Ensure no vents are blocked and check that there is enough clearance around the power supply.

Listen for the self-test fan noise from the cooling fan when you turn on the unit again.

If you cannot hear this self-test fan noise on power-up, then the fan is at fault; do not use the power supply and contact BK Precision.

6.3 OCP: Over Current Protection

Normally the over-current protection is provided by the constant current mode. If constant current mode fails and is not detected, it may cause serious damage to your load. The OCP is to minimize the damage to your load if the power supply's constant current control fails.



Figure 25 - OCP Warning

To reset the warning:

1. Switch off your power supply as soon as you see the OCP warning as shown below.
2. To reset this warning, disconnect the load and press the Output ON/OFF key.
3. Reconnect the load and the power supply should resume normal operation once power is turned on again.
4. If this problem cannot be fixed, please contact and consult BK Precision.

7 Specifications

Models	9103	9104
Output Rating		
Variable Output Voltage	0 - 42 VDC	0 - 84 VDC
Variable Output Current	0 - 20 A	0 - 10 A
Maximum Output Power	320 W	
Voltage Regulation		
Load (0 - 100% of rated current)	≤ 120 mV	≤ 100 mV
Line (90 - 264 VAC variation)	≤ 10 mV	
Current Regulation		
Load (10 - 90% rated voltage)	≤ 50 mA	
Line (90 - 264 VAC variation)	≤ 10 mA	
Ripple & Noise		
Ripple & Noise Voltage (rms)	≤ 8 mVrms	≤ 8 mVrms
Ripple & Noise Voltage (peak-peak)	≤ 80 mVp-p	≤ 80 mVp-p
Ripple & Noise Current (peak-peak)	≤ 200 mA	≤ 50 mA
Meter Type & Accuracy		
Voltage Meter	4 Digit LED Display ±(0.1% + 5 counts)	
Current Meter	4 Digit LED Display ±(0.1% + 5 counts)	
Output Resolution		
Output Voltage	0.02 V	
Output Current	0.01 A	
Output Setting Accuracy		
Output Voltage	±(0.2% + 0.05)	
Output Current	±(0.2% + 0.05)	
Output Rise & Fall Time (typical)		
Rise Time (50% load current)	≤ 80 ms	≤ 140 ms
Rise Time (maximum current)	≤ 1200 ms	≤ 1800 ms
Fall Time (50% load current)	≤ 90 ms	≤ 150 ms
Fall Time (100% load current)	≤ 50 ms	≤ 90 ms
General		
AC Input	90 - 264 VAC, 45 - 65 Hz	
AC Input Fuse	T5AL250V	

Power Consumption (typical)	≤ 372 W (230 VAC) ≤ 385 W (100 VAC)	≤ 367 W (230 VAC) ≤ 380 W (100 VAC)
Efficiency (typical)	≥ 86% (230 VAC) ≥ 83% (100 VAC)	≥ 87% (230 VAC) ≥ 84% (100 VAC)
Power Factor Control	Power factor correction > 0.91 at optimal load	
Full Load Input Current	≤ 1.8 A (230 VAC) ≤ 4.1 A (100 VAC)	
No Load Input Current	≤ 300 mA (230 VAC / 100 VAC)	
Protection Features	Adjustable upper voltage limit, adjustable upper current limit, Short Circuit, Overload, Over Temperature, Tracking OVP	
Tracking Over Voltage Protections	0 - 10 V: Set Voltage + (1.5 V ± 0.5 V) 10 V- 42 V: 115 % - 130% of set voltage	0 - 10 V: Set Voltage + (1.5 V ± 0.5 V) 10 V - 84 V: 115 % - 130 % of set voltage or > 90 V
Switching Frequency	45 - 55 kHz	
Cooling Method	Thermostatic control fan from 0 to full speed	
Transient Response Time (50 - 100% Load)	≤ 2.0 ms	
Safety & EMC		
Safety Standard	CE: EN 61010	
EMC	CE: EN55011	
Harmonics Current Emission	EN 61000-3-2	
Voltage Fluctuations & Flicker	EN 61000-3-3	
EMC Immunity	EN 61000-6-1	
Environment		
Operating Temperature	0 °C to +40 °C	
Working Humidity	10-80% relative humidity, non-condensing	
Storage Temperature and Humidity	-15 °C to +70 °C 10 - 85% relative humidity, non-condensing	
Pollution Degree	Class 2	
Dimensions and Weight		
Dimensions (W x H x D)	200 x 90 x 250 mm (7.9 x 3.6 x 10 inch)	
Weight	2.5 kg (5.5 lb)	
<i>Two-Year Warranty</i>		
Included Accessories	Power cord, USB cable, remote control connector, test report	

Service Information

Warranty Service: Please go to the support and service section on our website at www.bkprecision.com to obtain an RMA #. Return the product in the original packaging with proof of purchase to the address below. Clearly state on the RMA the performance problem and return any leads, probes, connectors, and accessories that you are using with the device.

Non-Warranty Service: Please go to the support and service section on our website at www.bkprecision.com to obtain an RMA #. Return the product in the original packaging to the address below. Clearly state on the RMA the performance problem and return any leads, probes, connectors, and accessories that you are using with the device. Customers not on an open account must include payment in the form of a money order or credit card. For the most current repair charges, please refer to the service and support section on our website.

Return all merchandise to B&K Precision Corp. with pre-paid shipping. The flat-rate repair charge for Non-Warranty Service does not include return shipping. Return shipping to locations in North America is included for Warranty Service. For overnight shipments and non-North American shipping fees, please contact B&K Precision Corp.

B&K Precision Corp.
22820 Savi Ranch Parkway
Yorba Linda, CA 92887
www.bkprecision.com
714-921-9095

Include with the returned instrument your complete return shipping address, contact name, phone number, and description of problem.

Limited Two-Year Warranty

B&K Precision Corp. warrants to the original purchaser that its products and the component parts thereof will be free from defects in workmanship and materials, for a period of **two years** from date of purchase.

B&K Precision Corp. will, without charge, repair or replace, at its option, defective product or component parts. Returned product must be accompanied by proof of the purchase date in the form of a sales receipt.

To obtain warranty coverage in the U.S.A., this product must be registered by completing a warranty registration form on our website www.bkprecision.com within fifteen (15) days of purchase.

Exclusions: This warranty does not apply in the event of misuse or abuse of the product or as a result of unauthorized alterations or repairs. The warranty is void if the serial number is altered, defaced, or removed.

B&K Precision Corp. shall not be liable for any consequential damages, including without limitation, damages resulting from loss of use. Some states do not allow limitations of incidental or consequential damages. So the above limitation or exclusion may not apply to you.

This warranty gives you specific rights and you may have other rights, which vary from state-to-state.

B&K Precision Corp.
22820 Savi Ranch Parkway
Yorba Linda, CA 92887
www.bkprecision.com
714-921-9095

BK PRECISION®

22820 Savi Ranch Parkway
Yorba Linda, CA 92887
www.bkprecision.com

© 2017 B&K Precision Corp.

v031417