

# PNP Epitaxial Silicon Transistor

## BD136 Series

### BD136 / BD138 / BD140

#### Applications

- Complement to BD135, BD137 and BD139 Respectively
- These are Pb-Free Devices

#### ABSOLUTE MAXIMUM RATINGS (T<sub>C</sub> = 25°C unless otherwise noted)

Rating	Symbol	Max	Unit
Collector-Base Voltage BD136 BD138 BD140	V <sub>CB0</sub>	-45 -60 -80	V
Collector-Emitter Voltage BD136 BD138 BD140	V <sub>CEO</sub>	-45 -60 -80	V
Emitter-Base Voltage	V <sub>EBO</sub>	-5	V
Collector Current (DC)	I <sub>C</sub>	-1.5	A
Collector Current (Pulse)	I <sub>CP</sub>	-3.0	A
Base Current	I <sub>B</sub>	-0.5	A

Stresses exceeding those listed in the Maximum Ratings table may damage the device. If any of these limits are exceeded, device functionality should not be assumed, damage may occur and reliability may be affected.

#### THERMAL CHARACTERISTICS

Rating	Symbol	Max	Unit
Collector Dissipation	P <sub>C</sub>	12.5	W
Collector Dissipation (T <sub>A</sub> = 25°C)	P <sub>C</sub>	1.25	W
Junction Temperature	T <sub>J</sub>	150	°C
Storage Temperature Range	T <sub>STG</sub>	-55~150	°C



ON Semiconductor®

[www.onsemi.com](http://www.onsemi.com)

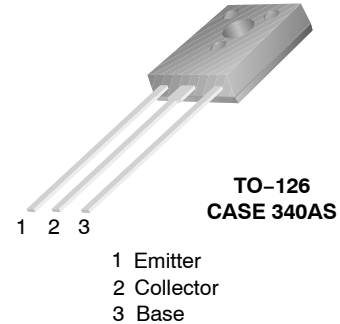

#### MARKING DIAGRAM

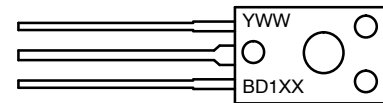

Y = Year  
 WW = Work Week  
 BD1XX = Specific Device Code  
 XX = 36, 38, 40

#### ORDERING INFORMATION

Device	Package	Shipping
BD13610STU	TO-126 (Pb-Free)	60 Units/ Tube
BD13610S		500 Units/ Bulk Box
BD13616STU		60 Units/ Tube
BD13616S		500 Units/ Bulk Box
BD13810STU		60 Units/ Tube
BD13816STU		60 Units/ Tube
BD14010STU		60 Units/ Tube
BD14016STU		60 Units/ Tube
BD14016S		500 Units/ Bulk Box

## BD136 Series

### ELECTRICAL CHARACTERISTICS ( $T_C = 25^\circ\text{C}$ unless otherwise noted)

Symbol	Parameter	Test Condition	Min.	Typ.	Max.	Units
$V_{CEO(sus)}$	Collector-Emitter Sustaining Voltage (Note 1) BD136 BD138 BD140	$I_C = -30\text{ mA}, I_B = 0$	-45 -60 -80			V
$I_{CBO}$	Collector Cut-off Current	$V_{CB} = -30\text{ V}, I_E = 0$			-0.1	$\mu\text{A}$
$I_{EBO}$	Emitter Cut-off Current	$V_{EB} = -5\text{ V}, I_C = 0$			-10	$\mu\text{A}$
$h_{FE1}$	DC Current Gain (Note 1)	$V_{CE} = -2\text{ V}, I_C = -5\text{ mA}$	25			
$h_{FE2}$		$V_{CE} = -2\text{ V}, I_C = -150\text{ mA}$ BD13610/BD13810/BD14010 BD13616/BD13816/BD14016	63 100		160 250	
$h_{FE3}$		$V_{CE} = -2\text{ V}, I_C = -500\text{ mA}$	25			
$V_{CE(sat)}$		Collector-Emitter Saturation Voltage (Note 1)	$I_C = 500\text{ mA}, I_B = 50\text{ mA}$			-0.5
$V_{BE(on)}$	Base-Emitter ON Voltage (Note 1)	$V_{CE} = -2\text{ V}, I_C = -0.5\text{ A}$			-1	V

Product parametric performance is indicated in the Electrical Characteristics for the listed test conditions, unless otherwise noted. Product performance may not be indicated by the Electrical Characteristics if operated under different conditions.

1. Pulse Test:  $PW = 350\ \mu\text{s}$ , duty Cycle = 2% Pulsed

TYPICAL PERFORMANCE CHARACTERISTICS

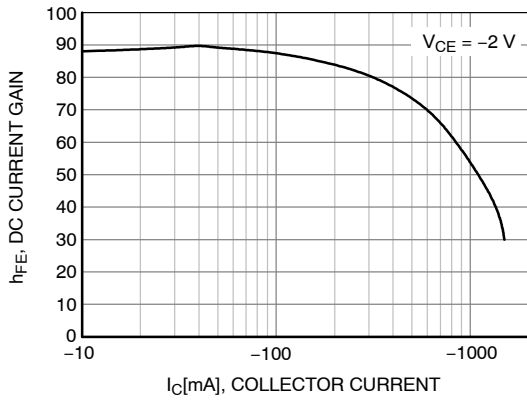

Figure 1. DC Current Gain

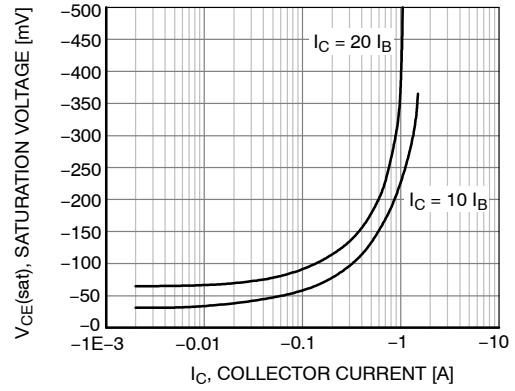

Figure 2. Collector-Emitter Saturation Voltage

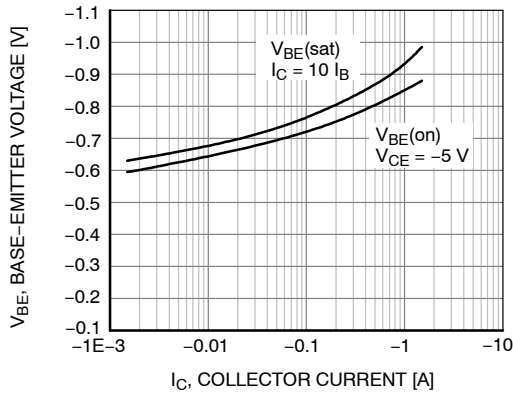

Figure 3. Base-Emitter Voltage

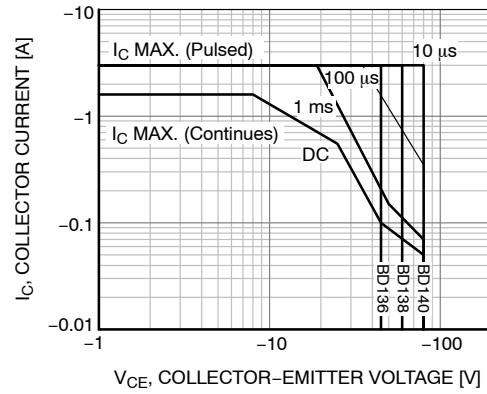

Figure 4. Safe Operating Area

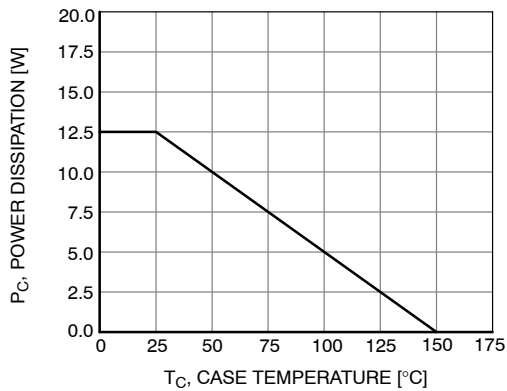

Figure 5. Power Derating

**MECHANICAL CASE OUTLINE**  
**PACKAGE DIMENSIONS**

ON Semiconductor®



TO-126-3LD  
CASE 340AS  
ISSUE O

DATE 30 SEP 2016

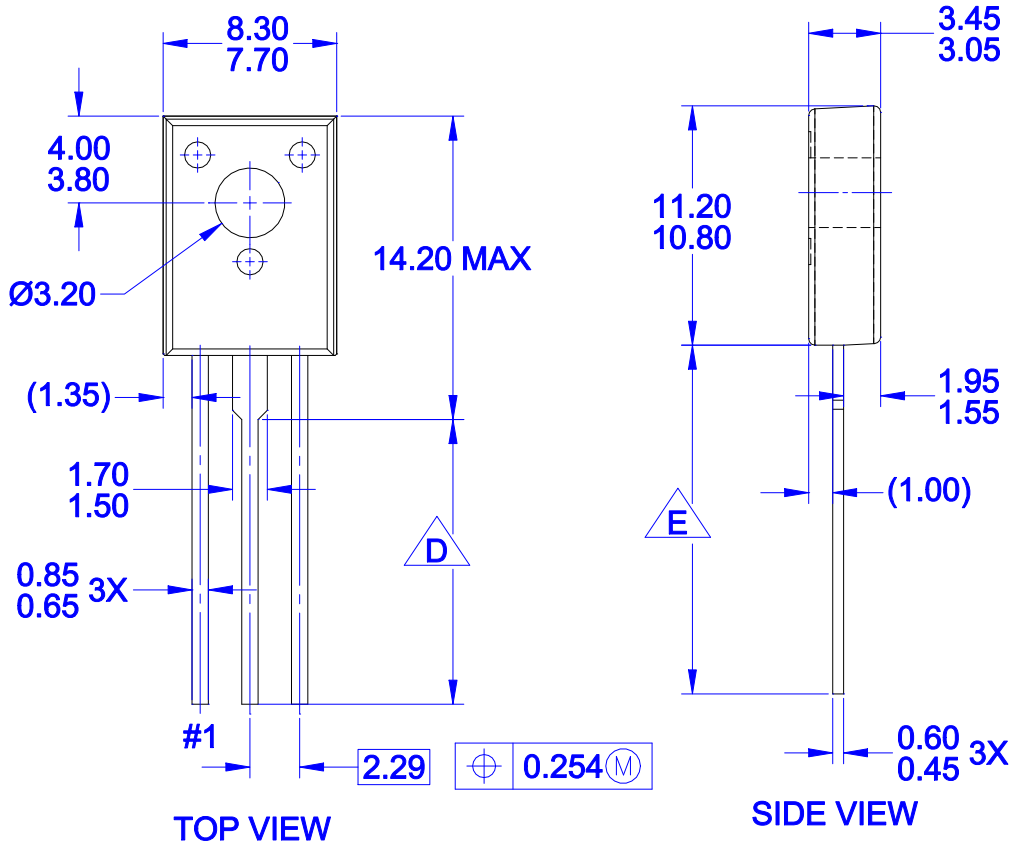

PRODUCTION CODE	TERMINAL LENGTH "D"	TERMINAL LENGTH "E"
TSSTU	3.45 - 4.05	6.45 - 7.45
TSTU	2.36 - 2.96	5.36 - 6.36
NONE (STD LENGTH)	12.76 - 13.36	15.76 - 16.76

**NOTES:**

- A. NO INDUSTRY STANDARD APPLIES TO THIS PACKAGE
- B. ALL DIMENSIONS ARE IN MILLIMETERS
- C. DIMENSIONS ARE EXCLUSIVE OF BURRS, MOLD FLASH, AND TIE BAR PROTRUSIONS

**D** FOR TERMINAL LENGTH "D", REFER TO TABLE

**E** FOR TERMINAL LENGTH "E", REFER TO TABLE

<b>DOCUMENT NUMBER:</b> 98AON13817G	Electronic versions are uncontrolled except when accessed directly from the Document Repository. Printed versions are uncontrolled except when stamped "CONTROLLED COPY" in red.
<b>DESCRIPTION:</b> TO-126-3LD	<b>PAGE 1 OF 1</b>

ON Semiconductor and are trademarks of Semiconductor Components Industries, LLC dba ON Semiconductor or its subsidiaries in the United States and/or other countries. ON Semiconductor reserves the right to make changes without further notice to any products herein. ON Semiconductor makes no warranty, representation or guarantee regarding the suitability of its products for any particular purpose, nor does ON Semiconductor assume any liability arising out of the application or use of any product or circuit, and specifically disclaims any and all liability, including without limitation special, consequential or incidental damages. ON Semiconductor does not convey any license under its patent rights nor the rights of others.

**onsemi**, **Onsemi**, and other names, marks, and brands are registered and/or common law trademarks of Semiconductor Components Industries, LLC dba "**onsemi**" or its affiliates and/or subsidiaries in the United States and/or other countries. **onsemi** owns the rights to a number of patents, trademarks, copyrights, trade secrets, and other intellectual property. A listing of **onsemi**'s product/patent coverage may be accessed at [www.onsemi.com/site/pdf/Patent-Marking.pdf](http://www.onsemi.com/site/pdf/Patent-Marking.pdf). **onsemi** reserves the right to make changes at any time to any products or information herein, without notice. The information herein is provided "as-is" and **onsemi** makes no warranty, representation or guarantee regarding the accuracy of the information, product features, availability, functionality, or suitability of its products for any particular purpose, nor does **onsemi** assume any liability arising out of the application or use of any product or circuit, and specifically disclaims any and all liability, including without limitation special, consequential or incidental damages. Buyer is responsible for its products and applications using **onsemi** products, including compliance with all laws, regulations and safety requirements or standards, regardless of any support or applications information provided by **onsemi**. "Typical" parameters which may be provided in **onsemi** data sheets and/or specifications can and do vary in different applications and actual performance may vary over time. All operating parameters, including "Typicals" must be validated for each customer application by customer's technical experts. **onsemi** does not convey any license under any of its intellectual property rights nor the rights of others. **onsemi** products are not designed, intended, or authorized for use as a critical component in life support systems or any FDA Class 3 medical devices or medical devices with a same or similar classification in a foreign jurisdiction or any devices intended for implantation in the human body. Should Buyer purchase or use **onsemi** products for any such unintended or unauthorized application, Buyer shall indemnify and hold **onsemi** and its officers, employees, subsidiaries, affiliates, and distributors harmless against all claims, costs, damages, and expenses, and reasonable attorney fees arising out of, directly or indirectly, any claim of personal injury or death associated with such unintended or unauthorized use, even if such claim alleges that **onsemi** was negligent regarding the design or manufacture of the part. **onsemi** is an Equal Opportunity/Affirmative Action Employer. This literature is subject to all applicable copyright laws and is not for resale in any manner.

## PUBLICATION ORDERING INFORMATION

### LITERATURE FULFILLMENT:

Email Requests to: [orderlit@onsemi.com](mailto:orderlit@onsemi.com)

**onsemi Website:** [www.onsemi.com](http://www.onsemi.com)

### TECHNICAL SUPPORT

**North American Technical Support:**

Voice Mail: 1 800-282-9855 Toll Free USA/Canada

Phone: 011 421 33 790 2910

**Europe, Middle East and Africa Technical Support:**

Phone: 00421 33 790 2910

For additional information, please contact your local Sales Representative