

OEM pressure transmitter for general industrial applications

Models O-10 (T), O-10 (5)

WIKA data sheet PE 81.65



Applications

- Hydraulics and pneumatics
- Pumps and compressors
- Machine building
- Building services

Special features

- Measuring ranges from 0 ... 6 to 0 ... 600 bar
- Non-linearity 0.5 %
- Standard industrial signals
- Electrical connection: Angular connector form A and C, circular connector M12 x 1, Metri-Pack series 150, cable outlet 2 m unshielded or shielded
- Many internationally customary process connections



Pressure transmitter model O-10 (T)

Description

The model O-10 pressure transmitter has been developed for a wide variety of industrial applications. The large range of process and electrical connections as well as all commonly used pressure ranges and output signals set the model O-10 apart.

For applications in which water is used as a medium we recommend a 5-fold overpressure safety in combination with a condensation-tight case.

Due to its specifications, its features and its price, the pressure transmitter is ideally suited to OEM applications, with an annual quantity requirement of more than 1,000 units of each article number. Accordingly, the minimum order quantity is 50 units per article number.

The model O-10 has been designed specifically for the demands of the global market. The pressure transmitter offers international units and the corresponding approvals for the North American and Russian markets.

It goes without saying that the model O-10 can be delivered with customer-specific labelling (e.g. company logo and model designation).

Versions

Model O-10 (T)

Standard version

Model O-10 (5)

With 5-fold overpressure limit and condensation-tight case

For applications with water as a medium we recommend a 5-fold overpressure safety for protection against water hammer effects, and a condensation-tight case.

Measuring ranges

■ Model O-10 (T)

Relative pressure							
bar	0 ... 6 ¹⁾²⁾	0 ... 10 ¹⁾²⁾	0 ... 16	0 ... 25	0 ... 40	0 ... 60	0 ... 100
	0 ... 160	0 ... 250	0 ... 400	0 ... 600			
psi	0 ... 100 ¹⁾²⁾	0 ... 160	0 ... 200	0 ... 250	0 ... 300	0 ... 400	0 ... 500
	0 ... 600	0 ... 750	0 ... 800	0 ... 1,000	0 ... 1,500	0 ... 2,000	0 ... 3,000
	0 ... 4,000	0 ... 5,000	0 ... 6,000	0 ... 7,500	0 ... 8,000		

Vacuum and +/- measuring range						
bar	-1 ... +5 ²⁾	-1 ... +9 ²⁾	-1 ... +15	-1 ... +24	-1 ... +39	-1 ... +59
psi	-30 inHg ... +100 ²⁾	-30 inHg ... +160	-30 inHg ... +200	-30 inHg ... +300	-30 inHg ... +500	

1) Measuring deviation of the zero signal $\leq \pm 0.7\%$ of span

2) Non-linearity $\leq \pm 0.6\%$ of span BFSL

The given measuring ranges are also available in kg/cm², kPa and MPa.
Other measuring ranges on request.

Overpressure limit

2 times, 3 times on request

Vacuum tightness

Yes

■ Model O-10 (5)

Relative pressure					
bar	0 ... 6	0 ... 10	0 ... 16	0 ... 25	0 ... 40

Other measuring ranges on request.

Overpressure limit

5 times

Vacuum tightness

Yes

Output signals

■ Model O-10 (T)

Signal type	Signal
Current (2-wire)	4 ... 20 mA
Voltage (3-wire)	DC 0.5 ... 4.5 V DC 0 ... 5 V DC 1 ... 5 V DC 0 ... 10 V
Ratiometric (3-wire)	DC 0.5 ... 4.5 V

Other output signals available on request.

Load in Ω

Current output (2-wire): $\leq (\text{power supply} - 8 \text{ V}) / 0.02 \text{ A}$
Voltage output (3-wire): $> \text{maximum output signal} / 1 \text{ mA}$
Ratiometric output signal (3-wire): $> 4.5 \text{ k}\Omega$

■ Model O-10 (T)

Signal type	Signal
Current (2-wire)	4 ... 20 mA
Voltage (3-wire)	DC 0.5 ... 4.5 V DC 1 ... 5 V
Ratiometric (3-wire)	DC 0.5 ... 4.5 V

Other output signals available on request.

Load in Ω

Current output (2-wire): $\leq (\text{power supply} - 8 \text{ V}) / 0.02 \text{ A}$
Voltage output (3-wire): $> \text{maximum output signal} / 1 \text{ mA}$
Ratiometric output signal (3-wire): $> 4.5 \text{ k}\Omega$

Voltage supply

Power supply

The power supply depends on the selected output signal.

4 ... 20 mA:	DC 8 ... 30 V
DC 0.5 ... 4.5 V:	DC 8 ... 30 V
DC 0 ... 5 V:	DC 8 ... 30 V
DC 1 ... 5 V:	DC 8 ... 30 V
DC 0 ... 10 V:	DC 14 ... 30 V
DC 0.5 ... 4.5 V (ratiometric):	DC 4.5 ... 5 V

The power supply for the pressure transmitter must be made via an energy-limited electrical circuit in accordance with section 9.4 of UL/EN/IEC 61010-1, or an LPS to UL/EN/IEC 60950-1, or class 2 in accordance with UL1310/UL1585 (NEC or CEC). The power supply must be suitable for operation above 2,000 m should the pressure transmitter be used at this altitude.

Total current consumption

Current output:

The total current consumption corresponds to the value of the output signal current (4 ... 20 mA), maximum 25 mA

Voltage output:

5 mA

Reference conditions (per IEC 61298-1)

Temperature

15 ... 25 °C

Atmospheric pressure

860 ... 1,060 mbar

Humidity

45 ... 75 % relative

Power supply

Current output: DC 14 V

Voltage output: DC 24 V

Ratiometric output signal: DC 5 V

Nominal position

Calibrated in vertical mounting position with pressure connection facing downwards.

Time response

Settling time

< 2 ms

Accuracy data

■ Model O-10 (T)

Non-linearity (per IEC 61298-2)

≤ ±0.5 % of span BFSL

A different non-linearity applies to some measuring ranges, see "Measuring ranges O-10 (T)".

Measuring deviation of the zero signal

≤ ±0.5 % of span

A different measuring deviation applies to some measuring ranges, see "Measuring ranges model O-10 (T)".

Accuracy at reference conditions

≤ ±1.2 % of span

Temperature error at 0 ... 80 °C

≤ ±1.5 % of span

Long-term stability

≤ ±0.3 % of span/year

■ Model O-10 (5)

Non-linearity (per IEC 61298-2)

≤ ±0.5 % of span BFSL

Measuring deviation of the zero signal

≤ ±1 % of span

Accuracy at reference conditions

≤ ±2.0 % of span

Temperature error at 0 ... 80 °C

Mean temperature coefficient of zero point:

Typical: 0.3 % of span/10 K

Maximum: 0.6 % of span/10 K

Mean temperature coefficient of span:

≤ ±0.1 % of span/10 K

Long-term drift

≤ ±0.8 % of span/year

Operating conditions

■ Model O-10 (T)

Ingress protection (per IEC 60529)

For ingress protections see "Electrical connections model O-10 (T)"

The stated ingress protection only applies when plugged in using mating connectors that have the appropriate ingress protection.

Vibration resistance (per IEC 60068-2-6)

20 g (20 ... 2,000 Hz, 120 min.)

Shock resistance (per IEC 60068-2-27)

40 g (6 ms), mechanical shock

Service life

10 million load cycles

Free fall test

Resistant to an impact onto concrete from 1 m

Permissible temperatures

Medium: -30 ... +100 °C

Ambient: -30 ... +100 °C

Storage: -30 ... +100 °C

■ Model O-10 (5)

Ingress protection (per IEC 60529)

For ingress protections see "Electrical connections model O-10 (5)"

The stated ingress protection only applies when plugged in using mating connectors that have the appropriate ingress protection.

Vibration resistance (per IEC 60068-2-6)

20 g (20 ... 2,000 Hz, 120 min)

Shock resistance (per IEC 60068-2-27)

40 g (6 ms), mechanical shock

Service life

10 million load cycles

Free fall test

Resistant to an impact onto concrete from 1 m

Permissible temperatures

Medium: -40 ... +100 °C

Ambient: -25 ... +80 °C

Storage: -25 ... +80 °C

Other temperature ranges on request

Process connections

Standard	Thread size
EN 837	G 1/8 B ²⁾
	G 1/4 B
	G 1/4 female
	G 3/8 B
DIN 3852-E	G 1/4 A ^{1) 3) 4)}
	M14 x 1.5 ³⁾
ANSI/ASME B1.20.1	1/8 NPT ²⁾
	1/4 NPT ¹⁾
	1/4 NPT female
ISO 7	R 1/4 ¹⁾
	R 3/8
KS	PT 1/4 ¹⁾
	PT 3/8
SAE	7/16-20 UNF BOSS ^{1) 3)}
	9/16-18 UNF BOSS ³⁾

1) Optional: Pressure port with a diameter of 6 mm, 0.6 mm, 0.3 mm on request.

2) Maximum measuring range from 0 ... 400 bar.

3) Minimum permissible medium temperature -30 °C, also for model O-10 (5)

4) Maximum overpressure limit 600 bar

All process connections are available, as standard, with a pressure port of diameter 3.5 mm.

Sealings

Process connection per	Standard	Option
DIN 3852-E	NBR ¹⁾	FPM/FKM ²⁾
SAE	FPM/FKM ²⁾	-

1) Minimum permissible medium and ambient temperature -15 °C

2) Minimum permissible medium and ambient temperature -30 °C

The sealings listed under "Standard" are included in the delivery.

Materials

Non-wetted parts

- Stainless steel 316L
- PBT GF 30
- Cable material (cable outlet) PVC

Wetted parts

- Stainless steel 316L
- 13-8 PH
- For sealing materials see "Process connections"

Oil and grease free versions are available on request.

Electrical connections

■ Model O-10 (T)

Available connections

Electrical connection	Ingress protection	Wire cross-section	Cable diameter	Cable lengths
Angular connector DIN 175301-803 A	IP 65	-	-	-
Angular connector DIN 175301-803 C	IP 65	-	-	-
Circular connector M12 x 1 (4-pin)	IP 67	-	-	-
Metri-Pack series 150 ¹⁾	IP 67	-	-	-
Cable outlet, unshielded ²⁾	IP 67	0.14 mm ²	3.4 mm	2 m , 5 m
Cable outlet, shielded	IP 67	0.14 mm ²	4.3 mm	2 m , 5 m

1) for model O-10 (T) only possible from measuring range 0 ... 60 bar

2) up to a maximum of 80 °C permitted

The stated ingress protection (per IEC 60529) only applies when plugged in using mating connectors that have the appropriate ingress protection.

Mating connectors are not included in the delivery, but they are available as accessories.

Other connections on request.

Short-circuit resistance

S₊ vs. 0V

Reverse polarity protection

U_B vs. 0V

Overvoltage protection

DC 36 V

Insulation voltage

DC 750 V

■ Model O-10 (5)

Available connections

Electrical connection	Ingress protection	Wire cross-section	Cable diameter	Cable lengths
Circular connector M12 x 1 (4-pin)	IP 65	-	-	-
Metri-Pack series 150	IP 67	-	-	-
Cable outlet, unshielded ¹⁾	IP 67	0.14 mm ²	3.4 mm	2 m , 5 m

1) up to a maximum of 80 °C permitted

The stated ingress protection (per IEC 60529) only applies when plugged in using mating connectors that have the appropriate ingress protection.

Mating connectors are not included in the delivery, but they are available as accessories.

Short-circuit resistance

S₊ vs. 0V

Reverse polarity protection

U_B vs. 0V

Overvoltage protection

DC 36 V

Insulation voltage

DC 750 V

Connection diagrams

Angular connector DIN 175301-803 A ^{1) 3)}			
	2-wire	3-wire	
	UB 1	1	1
	0V 2	2	2
	S+ -	-	3

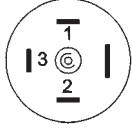
Angular connector DIN 175301-803 C ^{1) 3)}			
	2-wire	3-wire	
	UB 1	1	1
	0V 2	2	2
	S+ -	-	3

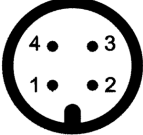
Circular connector M12 x 1 ^{1) 2) 3)}			
	2-wire	3-wire	
	UB 1	1	1
	0V 3	3	3
	S+ -	-	4

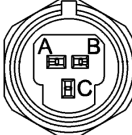
Metri-Pack series 150 ^{1) 2) 3)}			
	2-wire	3-wire	
	UB B	B	B
	0V A	A	A
	S+ -	-	C

Cable outlet, unshielded ^{1) 2) 3)}			
	2-wire	3-wire	
	UB brown	brown	brown
	0V green	green	green
	S+ -	-	white

Cable outlet, shielded ^{1) 3)}			
	2-wire	3-wire	
	UB brown	brown	brown
	0V blue	blue	blue
	S+ -	-	black

- 1) Applies to model O-10 (T)
 2) Applies to model O-10 (S)
 3) Version with connected shield on request

Legend	
UB	Positive power supply terminal
0V	Reference potential
S+	Positive output terminal

Dimensions in mm

Complete instrument

with angular connector
DIN 175301-803 A

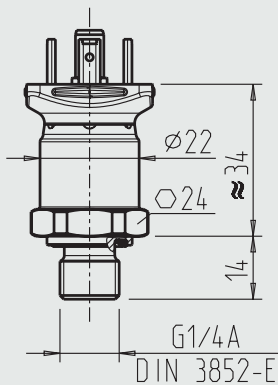

Weight: approx. 80 g

with angular connector
DIN 175301-803 C

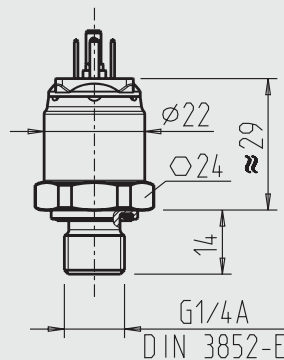

Weight: approx. 80 g

with M12 x 1 circular connector

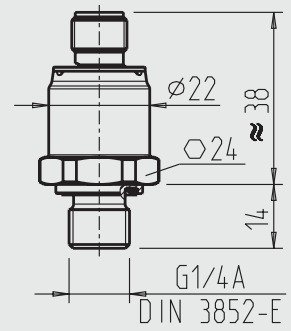

Weight: approx. 80 g

Complete instrument

with Metri-Pack series 150

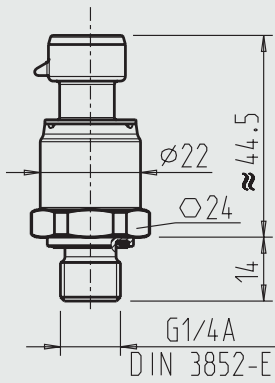

Weight: approx. 80 g

with cable outlet

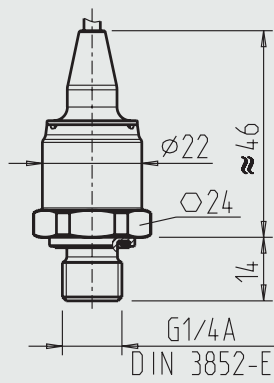

Weight: approx. 80 g

Process connections

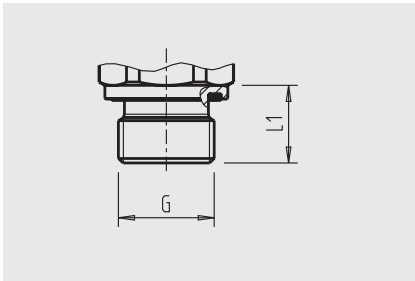

G	L1
G 1/4 A DIN 3852-E	14
M14 x 1.5 DIN 3852-E	14

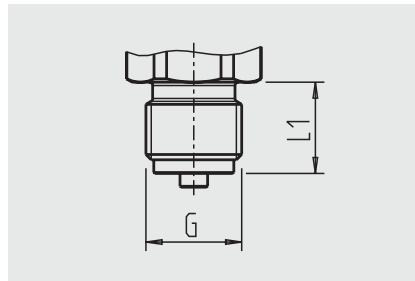

G	L1
G 1/4 B EN 837	13
G 3/8 B EN 837	16

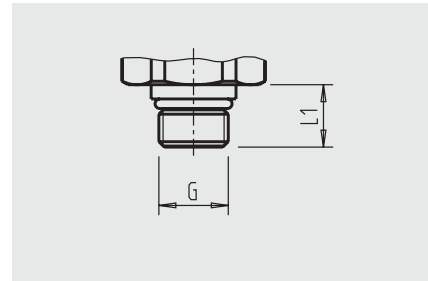

G	L1
9/16-18 UNF BOSS	13
7/16-20 UNF BOSS	12

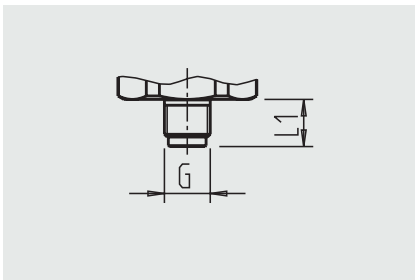

G	L1
G 1/8 B EN 837	10

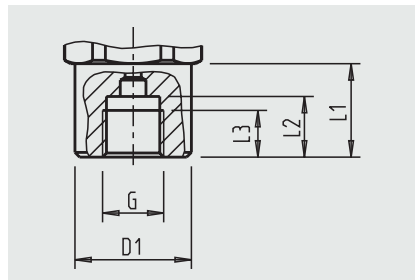

G	L1	L2	L3	D1
G 1/4	17	13	10	Ø 19

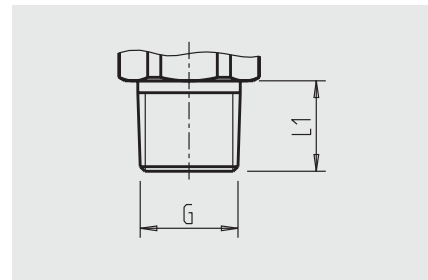

G	L1
1/8 NPT	10
1/4 NPT	13
R 1/4	13
R 3/8	15
PT 1/4	13
PT 3/8	15

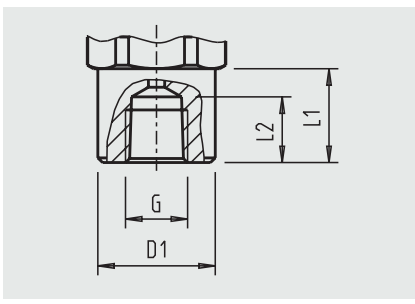

G	L1	L2	D1
1/4 NPT	17	14	Ø 19

For information on tapped holes and welding sockets, see Technical Information IN 00.14 at www.wika.com.

CE conformity

Pressure equipment directive
97/23/EC

EMC directive
2004/108/EC, EN 61326 emission (group 1, class B) and immunity (industrial application)

RoHS conformity
Yes

Approvals

- **cULus**, safety (e.g. electr. safety, overpressure, ...), USA, Canada
- **GOST-R**, import certificate, Russia

Approvals see website

Accessories and spare parts

Mating connector

Designation	Order number		
	without cable	with 2 m cable	with 5 m cable
Angular connector DIN 175301-803 A			
■ with cable gland, metric	11427567	11225793	11250186
■ with cable gland, conduit	11022485	-	-
Angular connector DIN 175301-803 C	1439081	11225823	11250194
Circular connector M12 x 1 (4-pin)			
■ straight	2421262	11250780	11250259
■ angled	2421270	11250798	11250232

Sealings for mating connectors

Designation of the mating connector	Order number
Angular connector DIN 175301-803 A	1576240
Angular connector DIN 175301-803 C	11169479

Only use the accessories and spare parts listed above, otherwise it could lead to the loss of the approval.

Ordering information

Model / Measuring range / Output signal / Process connection / Electrical connection

