

# 5SNG 1000X170300

## LinPak phase leg IGBT module

$$V_{CE} = 1700 \text{ V}$$

$$I_C = 2 \times 1000 \text{ A}$$

Ultra low inductance phase-leg module  
 Compact design with very high current density  
 Paralleling without derating  
 AISiC base-plate for high power cycling capability  
 AlN substrate for low thermal resistance  
 Low-loss, fast and rugged SPT++ chip-set



### Maximum rated values <sup>1)</sup>

Parameter	Symbol	Conditions	min	max	Unit
Collector-emitter voltage	$V_{CES}$	$V_{GE} = 0 \text{ V}$ , $T_{vj} \geq 25 \text{ °C}$		1700	V
DC collector current	$I_C$	$T_C = 100 \text{ °C}$ , $T_{vj} = 175 \text{ °C}$		1000	A
Peak collector current	$I_{CM}$	$t_p = 1 \text{ ms}$		2000	A
Gate-emitter voltage	$V_{GES}$		-20	20	V
Total power dissipation	$P_{tot}$	$T_C = 25 \text{ °C}$ , $T_{vj} = 175 \text{ °C}$		5500	W
DC forward current	$I_F$			1000	A
Peak forward current	$I_{FRM}$	$t_p = 1 \text{ ms}$		2000	A
Surge current	$I_{FSM}$	$V_R = 0 \text{ V}$ , $T_{vj} = 175 \text{ °C}$ , $t_p = 10 \text{ ms}$ , half-sinewave		5400	A
IGBT short circuit SOA	$t_{psc}$	$V_{CC} = 1300 \text{ V}$ , $V_{CEM \text{ CHIP}} \leq 1700 \text{ V}$ $V_{GE} \leq 15 \text{ V}$ , $T_{vj \text{ start}} \leq 150 \text{ °C}$		10	$\mu\text{s}$
Isolation voltage	$V_{ISOL}$	1 min, $f = 50 \text{ Hz}$		4000	V
Junction temperature	$T_{vj}$		-40	175	$^{\circ}\text{C}$
Junction operating temperature	$T_{vj(op)}$		-40	175	$^{\circ}\text{C}$
Case temperature	$T_C$		-40	150	$^{\circ}\text{C}$
Storage temperature	$T_{stg}$		-40	125	$^{\circ}\text{C}$
Mounting torques <sup>2)</sup>	$M_s$	Base-heatsink, M6 screws	4	6	Nm
	$M_{t1}$	Main terminals, M8 screws	8	10	
	$M_{t2}$	Auxiliary terminals, M3 screws	0.9	1.1	

<sup>1)</sup> Maximum rated values indicate limits beyond which damage to the device may occur per IEC 60747

<sup>2)</sup> For detailed mounting instructions refer to ABB Document No. 5SYA 2039

### IGBT characteristic values <sup>3)</sup>

Parameter	Symbol	Conditions	min	typ	max	Unit
Collector (-emitter) breakdown voltage	$V_{(BR)CES}$	$V_{GE} = 0\text{ V}$ , $I_C = 10\text{ mA}$ , $T_{vj} = 25\text{ °C}$	1700			V
Collector-emitter <sup>4)</sup> saturation voltage	$V_{CE\text{ sat}}$	$I_C = 1000\text{ A}$ , $V_{GE} = 15\text{ V}$	$T_{vj} = 25\text{ °C}$	2.25	2.5	V
			$T_{vj} = 125\text{ °C}$	2.55	2.8	V
			$T_{vj} = 175\text{ °C}$	2.75		V
Collector cut-off current	$I_{CES}$	$V_{CE} = 1700\text{ V}$ , $V_{GE} = 0\text{ V}$	$T_{vj} = 25\text{ °C}$	0.003		mA
			$T_{vj} = 125\text{ °C}$	2.55		mA
			$T_{vj} = 175\text{ °C}$	55		mA
Gate leakage current	$I_{GES}$	$V_{CE} = 0\text{ V}$ , $V_{GE} = \pm 20\text{ V}$ , $T_{vj} = 125\text{ °C}$	-500		500	nA
Gate-emitter threshold voltage	$V_{GE(TO)}$	$I_C = 40\text{ mA}$ , $V_{CE} = V_{GE}$ , $T_{vj} = 25\text{ °C}$		5.9		V
Gate charge	$Q_{ge}$	$I_C = 1000\text{ A}$ , $V_{CE} = 900\text{ V}$ , $V_{GE} = -15\text{ V} \dots 15\text{ V}$		6.4		$\mu\text{C}$
Input capacitance	$C_{ies}$	$V_{CE} = 25\text{ V}$ , $V_{GE} = 0\text{ V}$ , $f = 1\text{ MHz}$ , $T_{vj} = 25\text{ °C}$		62		nF
Output capacitance	$C_{oes}$			5.3		nF
Reverse transfer capacitance	$C_{res}$			3.8		nF
Internal gate resistance	$R_{Gint}$	per switch		0.75		$\Omega$
Turn-on delay time	$t_{d(on)}$	$V_{CC} = 900\text{ V}$ , $I_C = 1000\text{ A}$ , $R_G = 0.39\text{ }\Omega$ , $C_{GE} = 0\text{ nF}$ , $V_{GE} = \pm 15\text{ V}$ , $L_\sigma = 20\text{ nH}$ , inductive load	$T_{vj} = 25\text{ °C}$	270		ns
			$T_{vj} = 125\text{ °C}$	290		ns
			$T_{vj} = 175\text{ °C}$	300		ns
Rise time	$t_r$	$V_{CC} = 900\text{ V}$ , $I_C = 1000\text{ A}$ , $R_G = 0.39\text{ }\Omega$ , $C_{GE} = 0\text{ nF}$ , $V_{GE} = \pm 15\text{ V}$ , $L_\sigma = 20\text{ nH}$ , inductive load	$T_{vj} = 25\text{ °C}$	80		ns
			$T_{vj} = 125\text{ °C}$	90		ns
			$T_{vj} = 175\text{ °C}$	100		ns
Turn-off delay time	$t_{d(off)}$	$V_{CC} = 900\text{ V}$ , $I_C = 1000\text{ A}$ , $R_G = 0.56\text{ }\Omega$ , $C_{GE} = 0\text{ nF}$ , $V_{GE} = \pm 15\text{ V}$ , $L_\sigma = 20\text{ nH}$ , inductive load	$T_{vj} = 25\text{ °C}$	570		ns
			$T_{vj} = 125\text{ °C}$	680		ns
			$T_{vj} = 175\text{ °C}$	730		ns
Fall time	$t_f$	$V_{CC} = 900\text{ V}$ , $I_C = 1000\text{ A}$ , $R_G = 0.56\text{ }\Omega$ , $C_{GE} = 0\text{ nF}$ , $V_{GE} = \pm 15\text{ V}$ , $L_\sigma = 20\text{ nH}$ , inductive load	$T_{vj} = 25\text{ °C}$	90		ns
			$T_{vj} = 125\text{ °C}$	120		ns
			$T_{vj} = 175\text{ °C}$	140		ns
Turn-on switching energy	$E_{on}$	$V_{CC} = 900\text{ V}$ , $I_C = 1000\text{ A}$ , $R_G = 0.39\text{ }\Omega$ , $C_{GE} = 0\text{ nF}$ , $V_{GE} = \pm 15\text{ V}$ , $L_\sigma = 20\text{ nH}$ , inductive load	$T_{vj} = 25\text{ °C}$	250		mJ
			$T_{vj} = 125\text{ °C}$	410		mJ
			$T_{vj} = 175\text{ °C}$	500		mJ
Turn-off switching energy	$E_{off}$	$V_{CC} = 900\text{ V}$ , $I_C = 1000\text{ A}$ , $R_G = 0.56\text{ }\Omega$ , $C_{GE} = 0\text{ nF}$ , $V_{GE} = \pm 15\text{ V}$ , $L_\sigma = 20\text{ nH}$ , inductive load	$T_{vj} = 25\text{ °C}$	190		mJ
			$T_{vj} = 125\text{ °C}$	280		mJ
			$T_{vj} = 175\text{ °C}$	350		mJ
Short circuit current	$I_{sc}$	$V_{CC} = 1300\text{ V}$ , $V_{GE} = 15\text{ V}$	$T_{vj\text{ start}} = 150\text{ °C}$	3000		A

<sup>3)</sup> Characteristic values according to IEC 60747 - 9

<sup>4)</sup> Collector-emitter saturation voltage is given at chip level

## Diode characteristic values <sup>5)</sup>

Parameter	Symbol	Conditions	min	typ	max	Unit
Forward voltage <sup>6)</sup>	V <sub>F</sub>	I <sub>F</sub> = 1000 A	T <sub>vj</sub> = 25 °C	1.6	1.9	V
			T <sub>vj</sub> = 125 °C	1.75	2.05	V
			T <sub>vj</sub> = 175 °C	1.7		V
Peak reverse recovery current	I <sub>RM</sub>		T <sub>vj</sub> = 25 °C	1130		A
			T <sub>vj</sub> = 125 °C	1160		A
			T <sub>vj</sub> = 175 °C	1230		A
Recovered charge	Q <sub>rr</sub>	V <sub>CC</sub> = 900 V, I <sub>F</sub> = 1000 A, V <sub>GE</sub> = ±15 V, R <sub>G</sub> = 0.39 Ω, C <sub>GE</sub> = 0 nF, L <sub>σ</sub> = 20 nH, inductive load	T <sub>vj</sub> = 25 °C	290		μC
			T <sub>vj</sub> = 125 °C	460		μC
			T <sub>vj</sub> = 175 °C	630		μC
Reverse recovery time	t <sub>rr</sub>		T <sub>vj</sub> = 25 °C	520		ns
			T <sub>vj</sub> = 125 °C	830		ns
			T <sub>vj</sub> = 175 °C	1040		ns
Reverse recovery energy	E <sub>rec</sub>		T <sub>vj</sub> = 25 °C	170		mJ
			T <sub>vj</sub> = 125 °C	260		mJ
			T <sub>vj</sub> = 175 °C	370		mJ

<sup>5)</sup> Characteristic values according to IEC 60747 - 2

<sup>6)</sup> Forward voltage is given at chip level

## NTC Thermistor

Parameter	Symbol	Conditions	min	typ	max	Unit
Rated resistor	R <sub>25</sub>			4.7		kΩ
B-value	B <sub>25/85</sub>	R <sub>2</sub> = R <sub>25</sub> exp [B <sub>25/85</sub> (1/T <sub>2</sub> - 1/(298.15K))]		3371		K
	B <sub>25/100</sub>	R <sub>2</sub> = R <sub>25</sub> exp [B <sub>25/100</sub> (1/T <sub>2</sub> - 1/(298.15K))]		3435		K

## Package properties <sup>7)</sup>

Parameter	Symbol	Conditions	min	typ	max	Unit
IGBT thermal resistance junction to case	R <sub>th(j-c)IGBT</sub>				27	K/kW
Diode thermal resistance junction to case	R <sub>th(j-c)DIODE</sub>				45	K/kW
IGBT thermal resistance <sup>2)</sup> case to heatsink	R <sub>th(c-s)IGBT</sub>	IGBT per switch, λ grease = 1W/m x K		27		K/kW
Diode thermal resistance <sup>2)</sup> case to heatsink	R <sub>th(c-s)DIODE</sub>	Diode per switch, λ grease = 1W/m x K		33		K/kW
Comparative tracking index	CTI		600			
Module stray inductance	L <sub>σ CE</sub>	total C1-E2		10		nH
Resistance, terminal-chip	R <sub>C1E1</sub> IGBT / Diode	T <sub>C</sub> = 25 °C		0.25 / 0.34		mΩ
		T <sub>C</sub> = 125 °C		0.35 / 0.47		
		T <sub>C</sub> = 175 °C		0.40 / 0.54		
	R <sub>C2E2</sub> IGBT / Diode	T <sub>C</sub> = 25 °C		0.35 / 0.45		
		T <sub>C</sub> = 125 °C		0.49 / 0.62		
		T <sub>C</sub> = 175 °C		0.56 / 0.71		

<sup>2)</sup> For detailed mounting instructions refer to ABB Document No. 5SYA 2039

## Mechanical properties <sup>7)</sup>

Parameter	Symbol	Conditions	min	typ	max	Unit
Dimensions	L x W x H	Typical		140 x 100 x 38		mm
Clearance distance in air	d <sub>a</sub>	according to IEC 60664-1 and EN 50124-1	Term. to base:	20		mm
			Term. to term:	8		
Surface creepage distance	d <sub>s</sub>	according to IEC 60664-1 and EN 50124-1	Term. to base:	30		mm
			Term. to term:	30		
Mass	m			820		g

<sup>7)</sup> Package and mechanical properties according to IEC 60747 - 15

## Electrical configuration

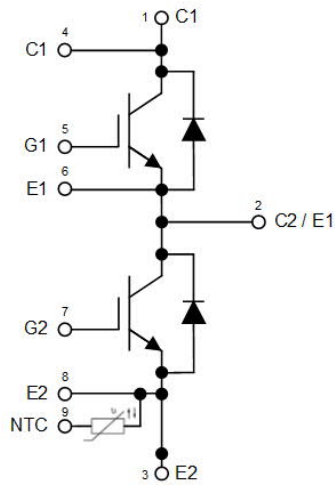

## Outline drawing

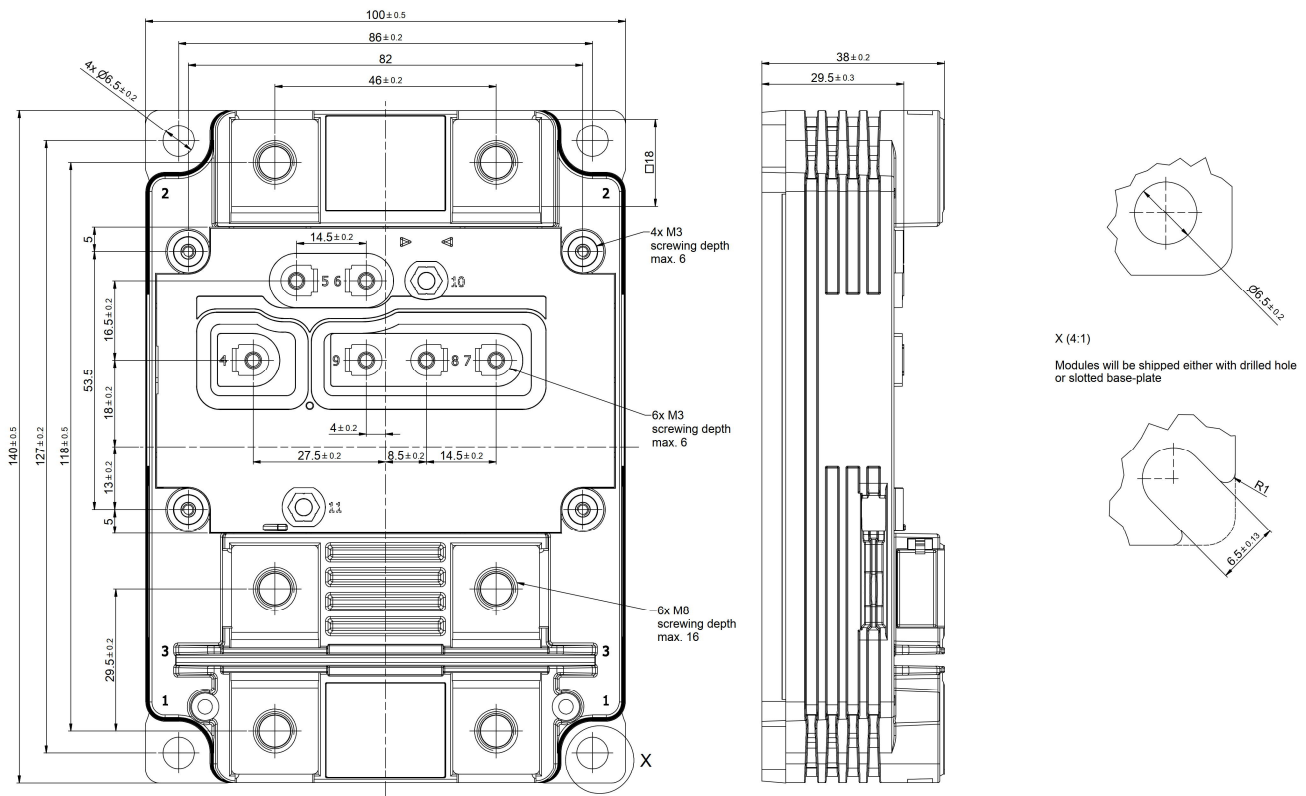

Note: all dimensions are shown in millimeters

This is an electrostatic sensitive device, please observe the international standard IEC 60747-1, chap. VIII.  
This product has been designed and qualified for Industrial Level.

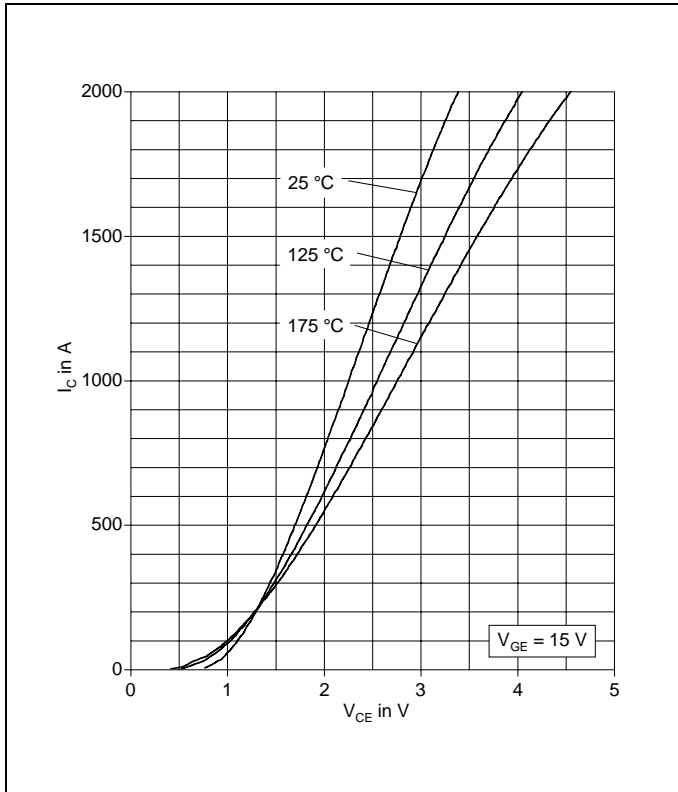

Fig. 1 Typical on-state characteristics, chip level

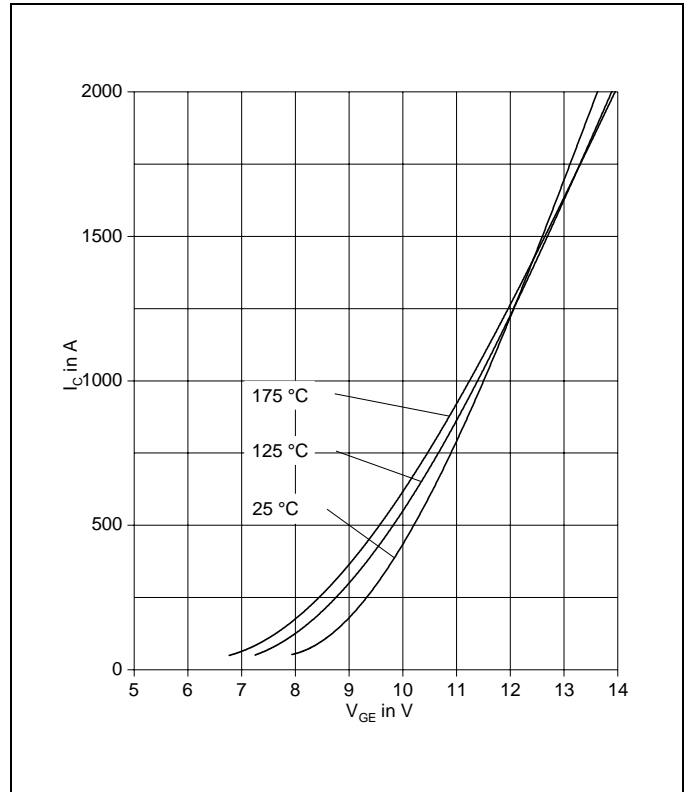

Fig. 2 Typical transfer characteristics, chip level

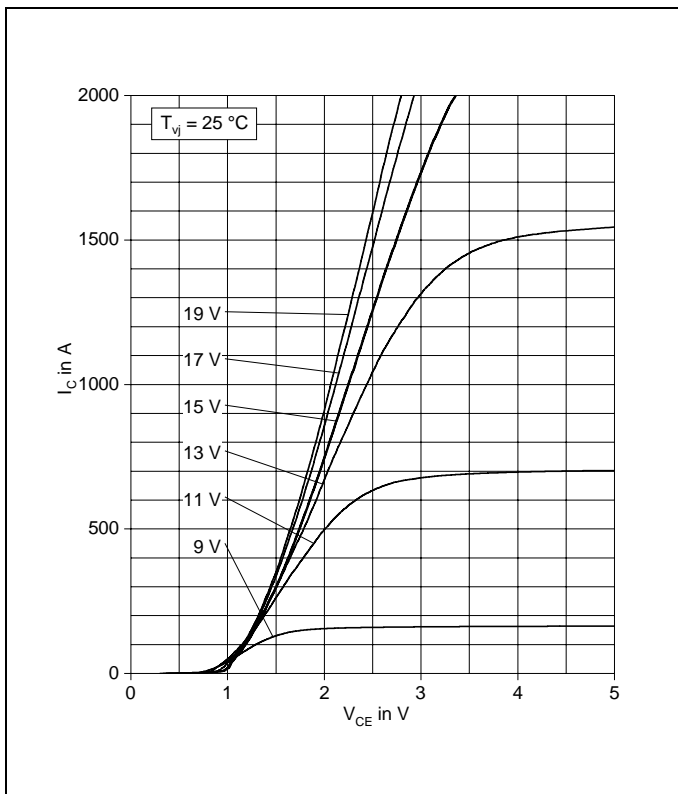

Fig. 3 Typical output characteristics, chip level

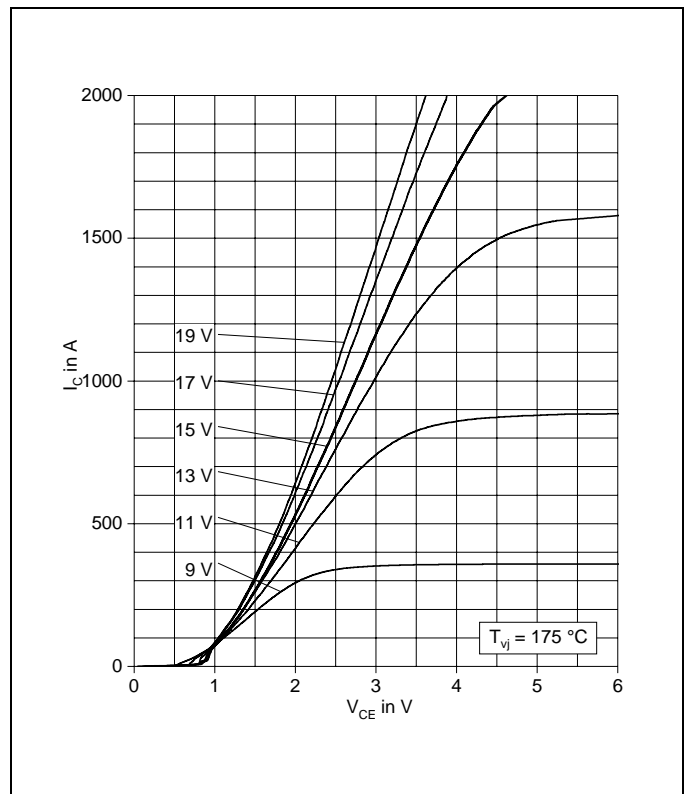

Fig. 4 Typical output characteristics, chip level

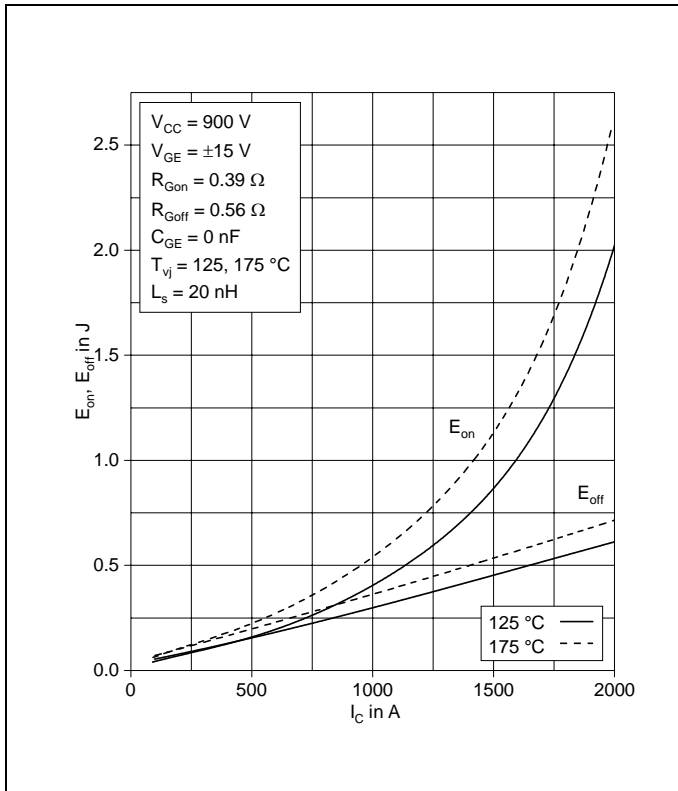

Fig. 5 Typical switching energies per pulse vs. collector current

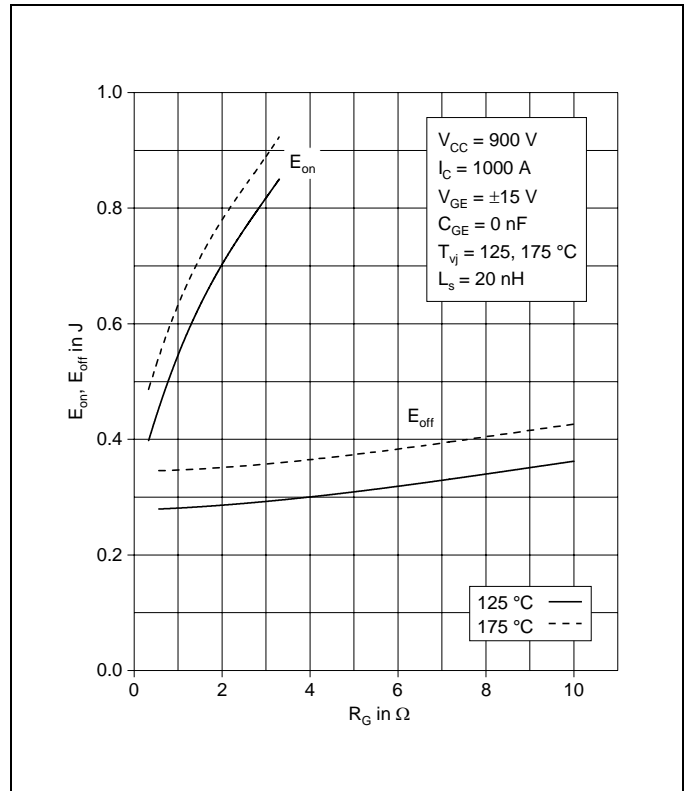

Fig. 6 Typical switching energies per pulse vs. gate resistor

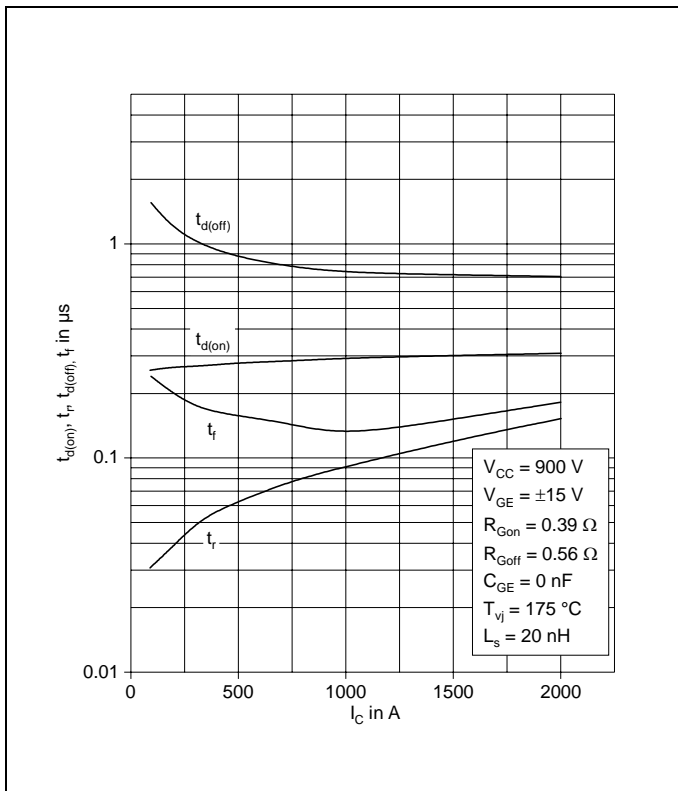

Fig. 7 Typical switching times vs. collector current

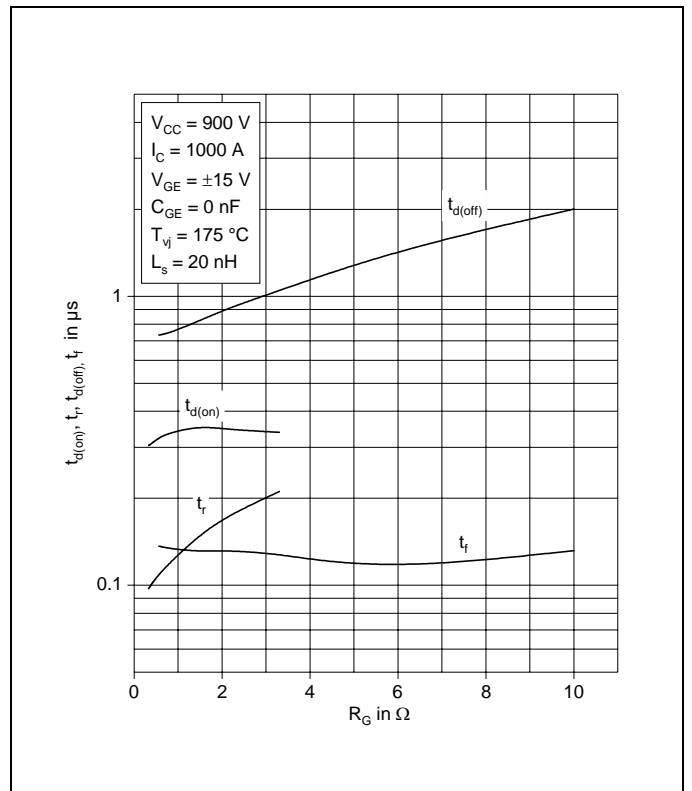

Fig. 8 Typical switching times vs. gate resistor

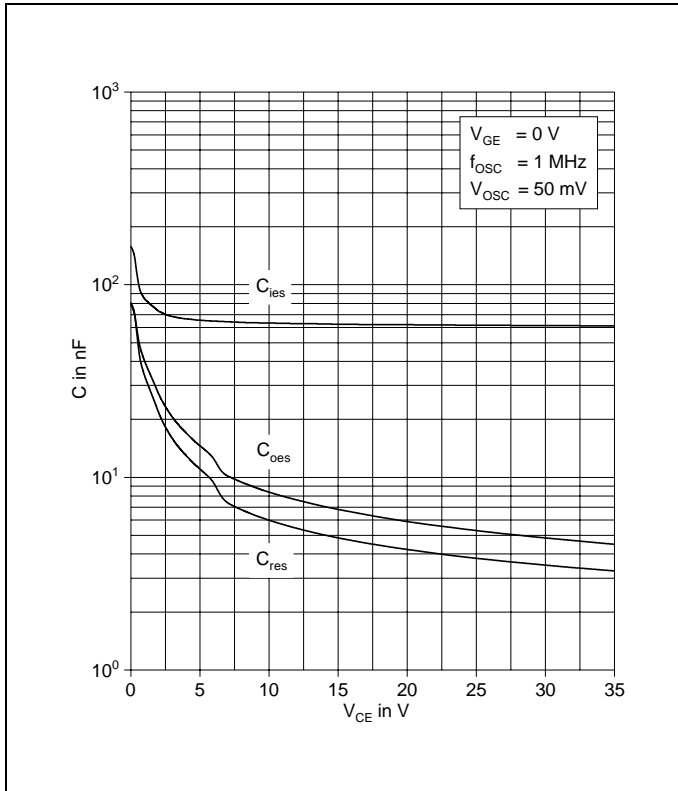

Fig. 9 Typical capacitances vs. collector-emitter voltage

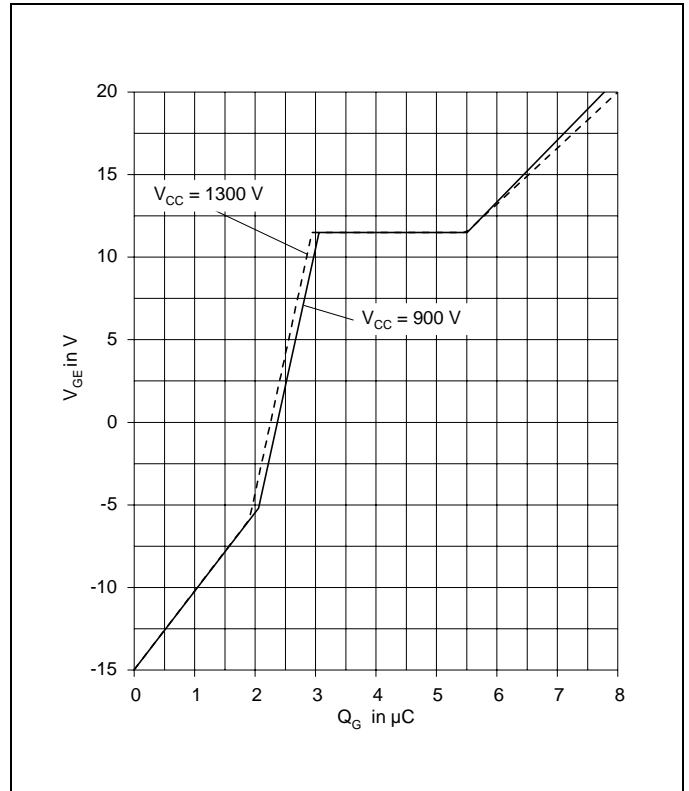

Fig. 10 Typical gate charge characteristics

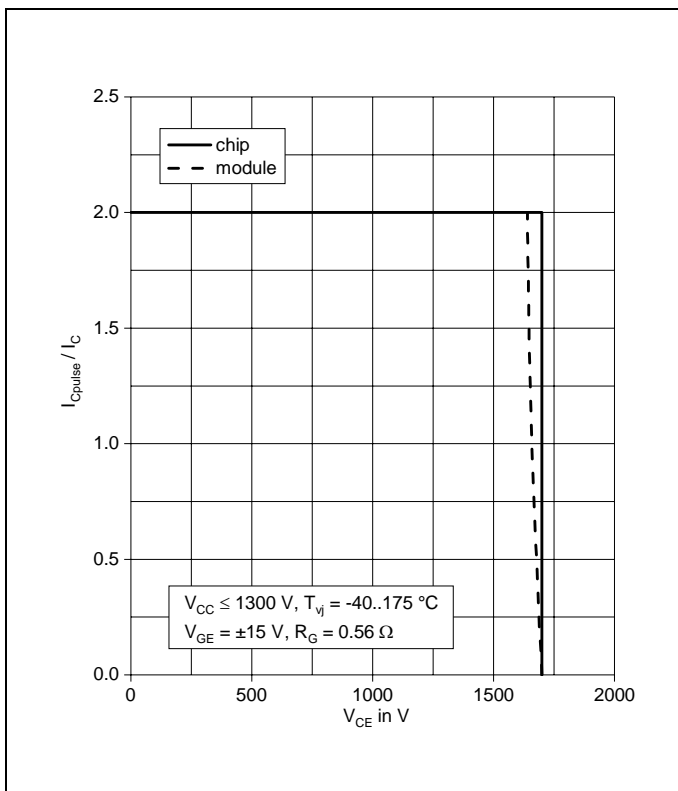

Fig. 11 Turn-off safe operating area (RBSOA)

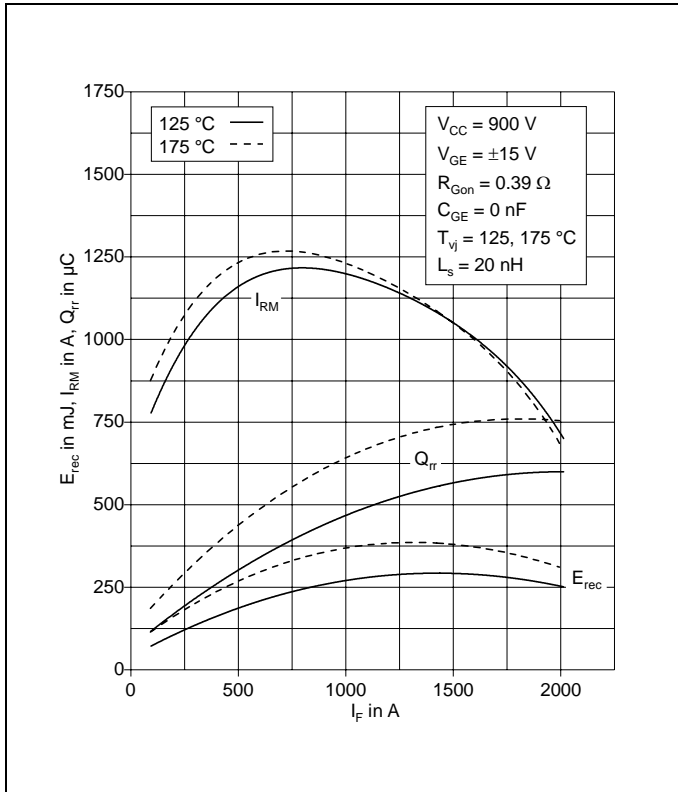

Fig. 12 Typical reverse recovery characteristics vs. forward current

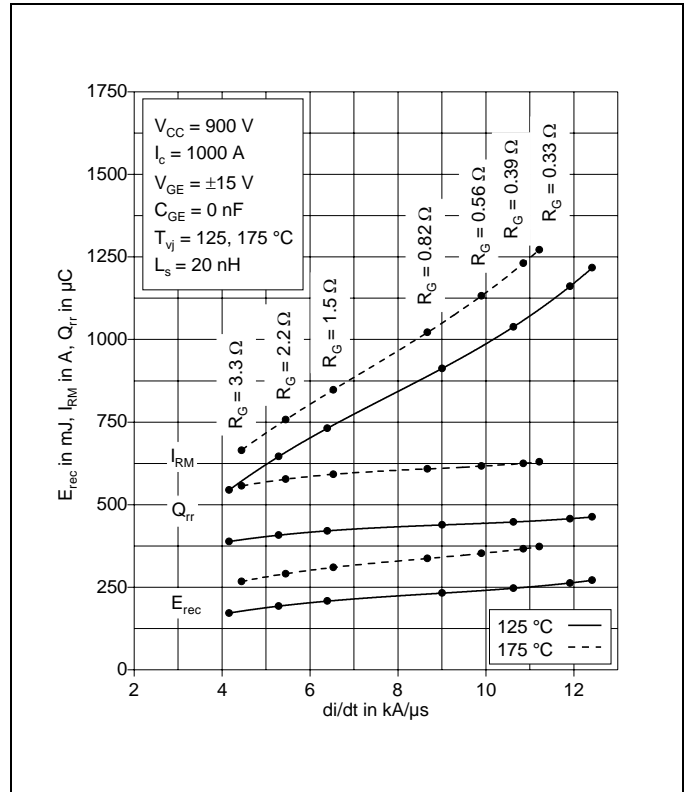

Fig. 13 Typical reverse recovery characteristics vs.  $di/dt$

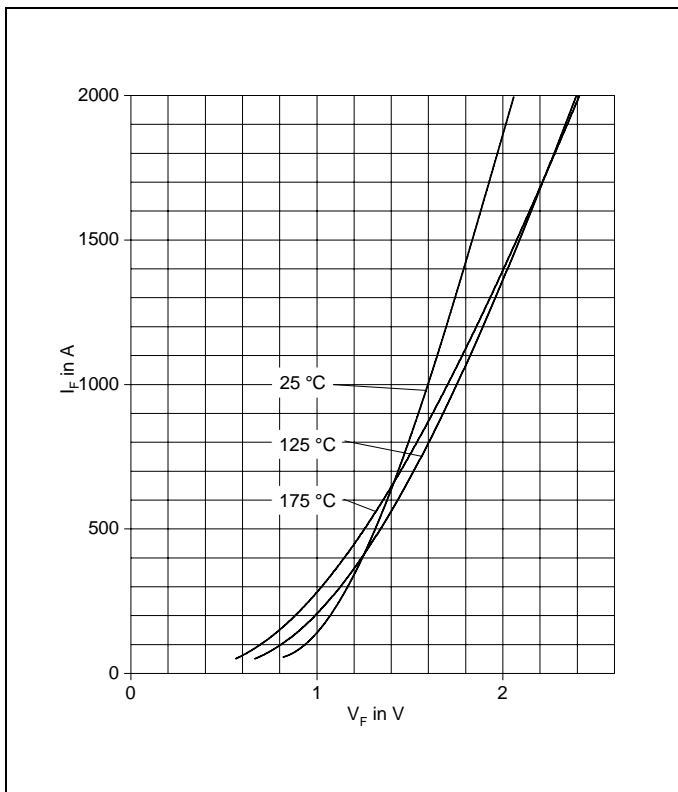

Fig. 14 Typical diode forward characteristics chip level

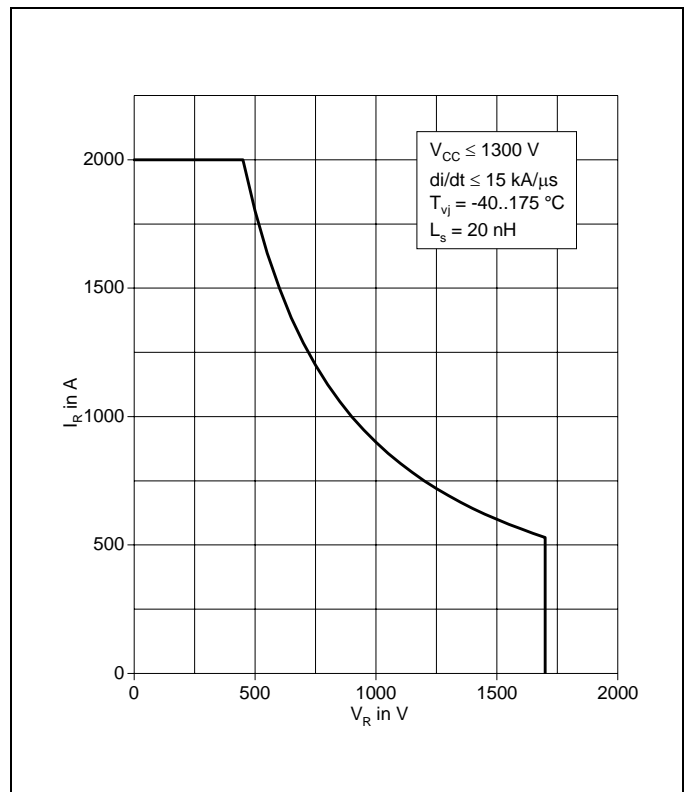

Fig. 15 Safe operating area diode (SOA)



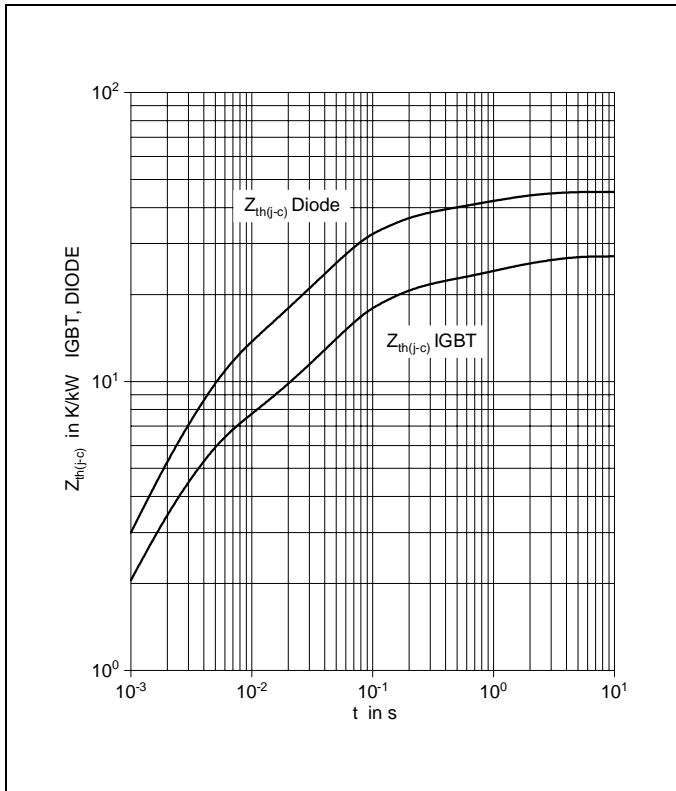

Fig. 16 Thermal impedance vs. time

Analytical function for transient thermal impedance:

$$Z_{th(j-c)}(t) = \sum_{i=1}^n R_i (1 - e^{-t/\tau_i})$$

	i	1	2	3	4	5
IGBT	Ri(K/kW)	15.0	6.48	5.58		
	$\tau_i$ (ms)	62.9	1280	2.55		
DIODE	Ri(K/kW)	26.3	10.0	8.96		
	$\tau_i$ (ms)	57.6	3.42	929		

#### Related documents:

- 5SYA 2042 Failure rates of IGBT modules due to cosmic rays
- 5SYA 2043 Load - cycle capability of HiPaks
- 5SYA 2045 Thermal runaway during blocking
- 5SYA 2053 Applying IGBT
- 5SYA 2057 IGBT diode safe operating area (SOA)
- 5SYA 2058 Surge currents for IGBT diodes
- 5SYA 2093 Thermal design of IGBT modules
- 5SYA 2098 Paralleling of IGBT modules
- 5SYA 2107 Mounting instructions for LinPak modules
- 5SZK 9111 Specification of environmental class for HiPak Storage
- 5SZK 9112 Specification of environmental class for HiPak Transportation
- 5SZK 9113 Specification of environmental class for HiPak Operation (Industry)
- 5SZK 9120 Specification of environmental class for HiPak

ABB Switzerland Ltd.  
Semiconductors  
Fabrikstrasse 3  
CH-5600 Lenzburg  
Switzerland

Phone: +41 58 586 1419  
Fax: +41 58 586 1306  
E-Mail: [abbsem@ch.abb.com](mailto:abbsem@ch.abb.com)  
Internet: [www.abb.com/semiconductors](http://www.abb.com/semiconductors)

We reserve the right to make technical changes or to modify the contents of this document without prior notice.

We reserve all rights in this document and the information contained therein. Any reproduction or utilization of this document or parts thereof for commercial purposes without our prior written consent is forbidden.

Any liability for use of our products contrary to the instructions in this document is excluded.