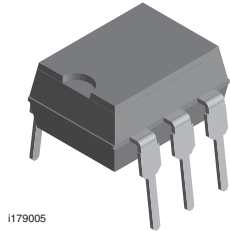
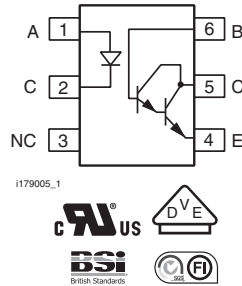


Optocoupler, Photodarlington Output, High Gain, With Base Connection



i179005



FEATURES

- Very high current transfer ratio, 500 % min.
- High isolation resistance, $10^{11} \Omega$ typical
- Standard plastic DIP package
- Material categorization: for definitions of compliance please see www.vishay.com/doc?99912



RoHS
COMPLIANT

AGENCY APPROVALS

- UL1577, file no. E52744 system code H
- DIN EN 60747-5-2 (VDE 0884) / DIN EN 60747-5-5 (pending), available with option 1
- BSI IEC 60950; IEC 60065
- FIMKO

DESCRIPTION

The 4N32 and 4N33 are optically coupled isolators with a gallium arsenide infrared LED and a silicon photodarlington sensor.

Switching can be achieved while maintaining a high degree of isolation between driving and load circuits.

These optocouplers can be used to replace reed and mercury relays with advantages of long life, high speed switching and elimination of magnetic fields.

ORDERING INFORMATION		
<div style="display: flex; justify-content: space-around; align-items: center;"> <div style="border: 1px solid black; padding: 2px;">4</div> <div style="border: 1px solid black; padding: 2px;">N</div> <div style="border: 1px solid black; padding: 2px;">3</div> <div style="border: 1px solid black; padding: 2px;">#</div> <div style="border: 1px solid black; padding: 2px;">-</div> <div style="border: 1px solid black; padding: 2px;">X</div> <div style="border: 1px solid black; padding: 2px;">0</div> <div style="border: 1px solid black; padding: 2px;">#</div> <div style="border: 1px solid black; padding: 2px;">#</div> <div style="border: 1px solid black; padding: 2px;">T</div> </div> <p style="text-align: center;">PART NUMBER PACKAGE OPTION TAPE AND REEL</p>		
AGENCY CERTIFIED/PACKAGE	CTR (%)	
UL, BSI, FIMKO	≥ 500	≥ 500
DIP-6	4N32	4N33

Note

- Additional options may be possible, please contact sales office



ABSOLUTE MAXIMUM RATINGS (T _{amb} = 25 °C, unless otherwise specified)				
PARAMETER	TEST CONDITION	SYMBOL	VALUE	UNIT
input				
Reverse voltage		V _R	3	V
Forward current		I _F	60	mA
Power dissipation		P _{diss}	100	mW
Derate linearly	From 55 °C		1.33	mW/°C
output				
Collector emitter breakdown voltage		BV _{CEO}	30	V
Emitter base breakdown voltage		BV _{EBO}	8	V
Collector base breakdown voltage		BV _{CBO}	50	V
Emitter collector breakdown voltage		BV _{ECO}	5	V
Collector (load) current		I _C	100	mA
Power dissipation		P _{diss}	150	mW
Derate linearly			2	mW/°C
coupler				
Total dissipation		P _{tot}	250	mW
Derate linearly			3.3	mW/°C
Isolation test voltage (between emitter	1 s	V _{ISO}	5300	V _{RMS}
Leakage path			7	mm min.
Air path			7	mm min.
Isolation resistance	V _{IO} = 500 V, T _{amb} = 25 °C	R _{IO}	≥ 10 ¹²	Ω
	V _{IO} = 500 V, T _{amb} = 100 °C	R _{IO}	≥ 10 ¹¹	Ω
Storage temperature		T _{stg}	-55 to +150	°C
Operating temperature		T _{amb}	-55 to +100	°C
Lead soldering time ⁽¹⁾	At 260 °C		10	s

Notes

- Stresses in excess of the absolute maximum ratings can cause permanent damage to the device. Functional operation of the device is not implied at these or any other conditions in excess of those given in the operational sections of this document. Exposure to absolute maximum ratings for extended periods of the time can adversely affect reliability
- ⁽¹⁾ Refer to reflow profile for soldering conditions for surface mounted devices (SMD). Refer to wave profile for soldering conditions for through hole devices (DIP)

ELECTRICAL CHARACTERISTICS (T _{amb} = 25 °C, unless otherwise specified)						
PARAMETER	TEST CONDITION	SYMBOL	MIN.	TYP.	MAX.	UNIT
input						
Forward voltage	I _F = 50 mA	V _F	-	1.25	1.5	V
Reverse current	V _R = 3 V	I _R	-	0.1	100	μA
Capacitance	V _R = 0 V	C _O	-	25		pF
output						
Collector emitter breakdown voltage ⁽¹⁾	I _C = 100 μA, I _F = 0	BV _{CEO}	30	-	-	V
Collector base breakdown voltage ⁽¹⁾	I _C = 100 μA, I _F = 0	BV _{CBO}	50	-	-	V
Emitter base breakdown voltage ⁽¹⁾	I _C = 100 μA, I _F = 0	BV _{EBO}	8	-	-	V
Emitter collector breakdown voltage ⁽¹⁾	I _C = 100 μA, I _F = 0	BV _{ECO}	5	10	-	V
Collector emitter leakage current	V _{CE} = 10 V, I _F = 0	I _{CEO}	-	1	100	nA
	I _C = 0.5 mA, V _{CE} = 5 V	h _{FE}	13	-	-	
coupler						
Collector emitter saturation voltage		V _{CEsat}	-	1	-	V
Coupling capacitance			-	1.5	-	pF

Notes

- Minimum and maximum values are testing requirements. Typical values are characteristics of the device and are the result of engineering evaluation. Typical values are for information only and are not part of the testing requirements
- ⁽¹⁾ Indicates JEDEC[®] registered values

CURRENT TRANSFER RATIO

PARAMETER	TEST CONDITION	SYMBOL	MIN.	TYP.	MAX.	UNIT
Current transfer ratio	$V_{CE} = 10\text{ V}$, $I_F = 10\text{ mA}$	CTR	500	-	-	%

SWITCHING CHARACTERISTICS

PARAMETER	TEST CONDITION	SYMBOL	MIN.	TYP.	MAX.	UNIT
Turn-on time	$V_{CC} = 10\text{ V}$, $I_C = 50\text{ mA}$	t_{on}	-	-	5	μs
Turn-off time	$I_F = 200\text{ mA}$, $R_L = 180\ \Omega$	t_{off}	-	-	100	μs

SAFETY AND INSULATION RATINGS

PARAMETER	TEST CONDITION	SYMBOL	MIN.	TYP.	MAX.	UNIT
Climatic classification	According to IEC 68 part 1		-	55 / 100 / 21	-	
Comparative tracking index		CTI	175	-	399	
V_{IOTM}			8000	-	-	V
V_{IORM}			890	-	-	V
P_{SO}			-	-	700	mW
I_{SI}			-	-	400	mA
T_{SI}			-	-	175	$^{\circ}\text{C}$
Creepage distance	Standard DIP-6		7	-	-	mm
Clearance distance	Standard DIP-6		7	-	-	mm
Insulation thickness, reinforced rated	Per IEC 60950 2.10.5.1		0.4	-	-	mm

Note

- As per IEC 60747-5-2, § 7.4.3.8.1, this optocoupler is suitable for "safe electrical insulation" only within the safety ratings. Compliance with the safety ratings shall be ensured by means of protective circuits

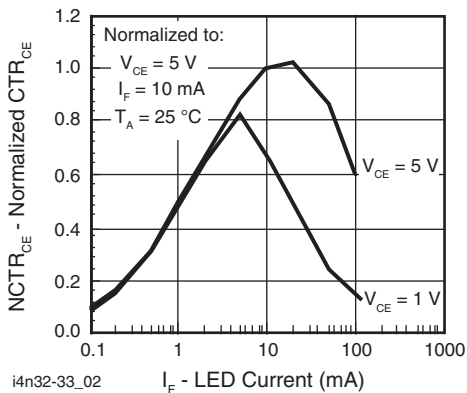
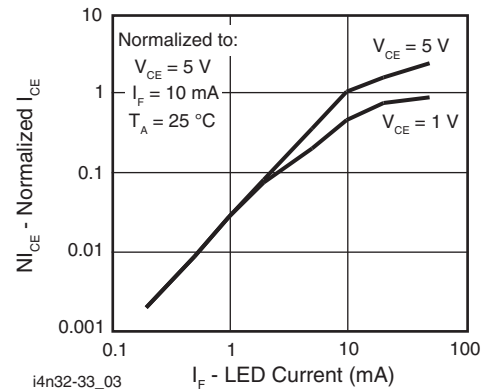
TYPICAL CHARACTERISTICS ($T_{amb} = 25\ ^{\circ}\text{C}$, unless otherwise specified)

 Fig. 1 - Normalized Non-Saturated and Saturated CTR_{CE} vs. LED Current


Fig. 2 - Normalized Non-Saturated and Saturated Collector Emitter Current vs. LED Current

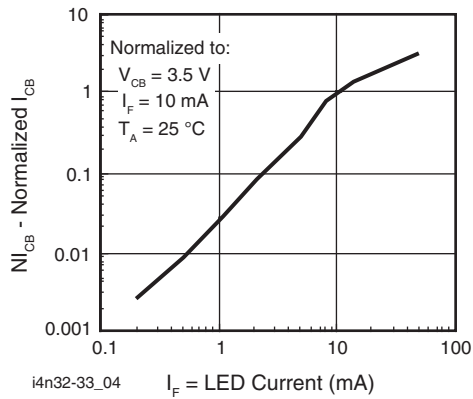


Fig. 3 - Normalized Collector Base Photocurrent vs. LED Current

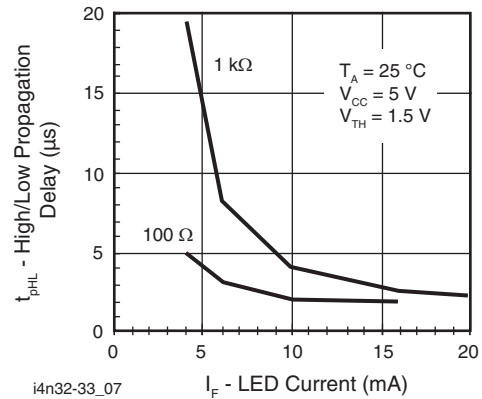


Fig. 6 - High to Low Propagation Delay vs. Collector Load Resistance and LED Current

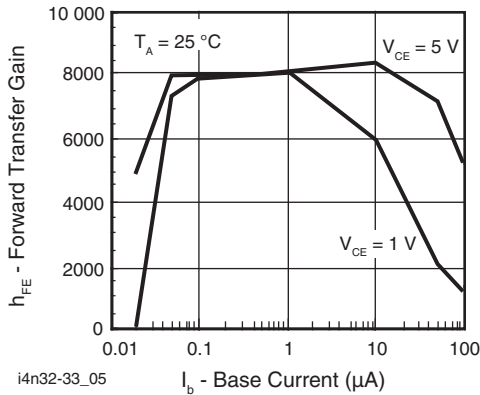
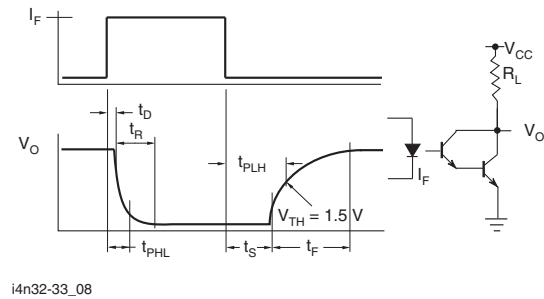


Fig. 4 - Non-Saturated and Saturated h_{FE} vs. Base Current



i4n32-33_08

Fig. 7 - Switching Waveform and Switching Schematic

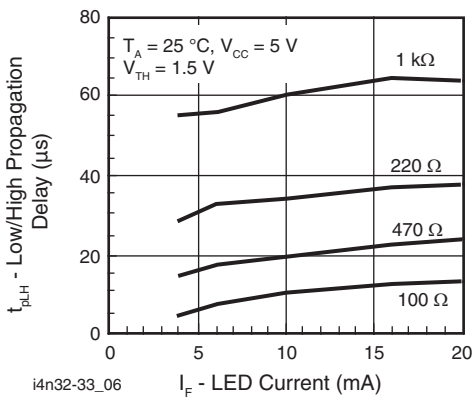
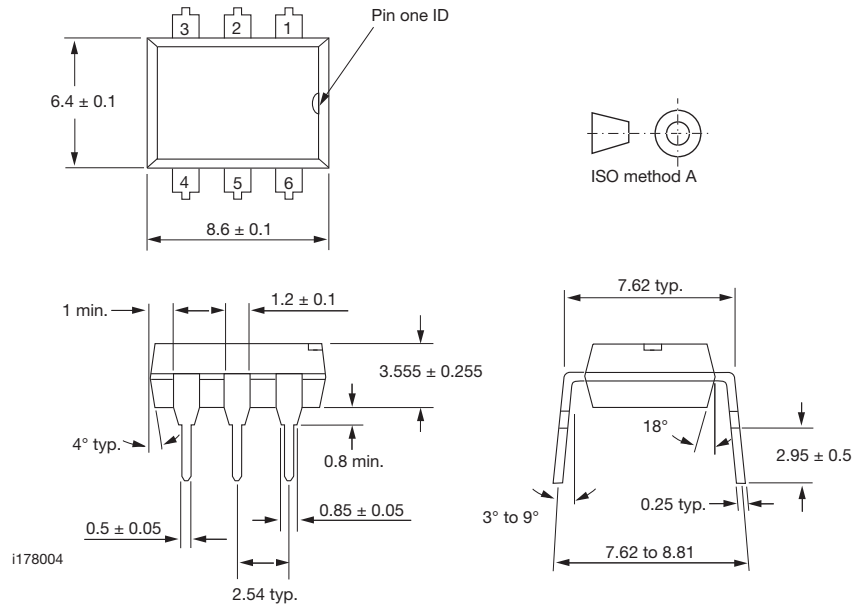


Fig. 5 - Low to High Propagation Delay vs. Collector Load Resistance and LED Current

PACKAGE DIMENSIONS in millimeters

DIP-6 Package Dimensions



PACKAGE MARKING



Notes

- Example marking for 4N32
- Only options 1, and 7 reflected in the package marking
- The VDE logo is only marked on option 1 parts
- Tape and reel suffix (T) is not part of the package marking



Disclaimer

ALL PRODUCT, PRODUCT SPECIFICATIONS AND DATA ARE SUBJECT TO CHANGE WITHOUT NOTICE TO IMPROVE RELIABILITY, FUNCTION OR DESIGN OR OTHERWISE.

Vishay Intertechnology, Inc., its affiliates, agents, and employees, and all persons acting on its or their behalf (collectively, "Vishay"), disclaim any and all liability for any errors, inaccuracies or incompleteness contained in any datasheet or in any other disclosure relating to any product.

Vishay makes no warranty, representation or guarantee regarding the suitability of the products for any particular purpose or the continuing production of any product. To the maximum extent permitted by applicable law, Vishay disclaims (i) any and all liability arising out of the application or use of any product, (ii) any and all liability, including without limitation special, consequential or incidental damages, and (iii) any and all implied warranties, including warranties of fitness for particular purpose, non-infringement and merchantability.

Statements regarding the suitability of products for certain types of applications are based on Vishay's knowledge of typical requirements that are often placed on Vishay products in generic applications. Such statements are not binding statements about the suitability of products for a particular application. It is the customer's responsibility to validate that a particular product with the properties described in the product specification is suitable for use in a particular application. Parameters provided in datasheets and / or specifications may vary in different applications and performance may vary over time. All operating parameters, including typical parameters, must be validated for each customer application by the customer's technical experts. Product specifications do not expand or otherwise modify Vishay's terms and conditions of purchase, including but not limited to the warranty expressed therein.

Except as expressly indicated in writing, Vishay products are not designed for use in medical, life-saving, or life-sustaining applications or for any other application in which the failure of the Vishay product could result in personal injury or death. Customers using or selling Vishay products not expressly indicated for use in such applications do so at their own risk. Please contact authorized Vishay personnel to obtain written terms and conditions regarding products designed for such applications.

No license, express or implied, by estoppel or otherwise, to any intellectual property rights is granted by this document or by any conduct of Vishay. Product names and markings noted herein may be trademarks of their respective owners.